



US00D428764S

United States Patent [19]

Kortleven et al.

[11] **Patent Number: Des. 428,764**

[45] **Date of Patent: ** Aug. 1, 2000**

[54] **CUTLERY HANDLE WITH UNDULATING LINE**

[75] Inventors: **Hanno Kortleven**, Hofstade; **Victor J.J. Cautereels**, Ranst, both of Belgium

[73] Assignee: **Dart Industries Inc.**, Orlando, Fla.

[**] Term: **14 Years**

[21] Appl. No.: **29/113,917**

[22] Filed: **Nov. 12, 1999**

[51] **LOC (7) Cl.** **07-03**

[52] **U.S. Cl.** **D7/401.2**

[58] **Field of Search** D7/642, 645, 649, D7/650, 652, 653, 662-664, 401.2; 30/147-150, 322, 324

[56] **References Cited**

U.S. PATENT DOCUMENTS

D. 159,702	8/1950	Wagner	D7/649
D. 334,117	3/1993	Shane-Schuldt	D7/662
D. 366,986	2/1996	Williams	D7/401.2
D. 398,814	9/1998	Stokes	D7/401.2

Primary Examiner—Caron D. Veynar

Attorney, Agent, or Firm—Taylor J. Ross

[57] **CLAIM**

The ornamental design for a cutlery handle with undulating line, as shown and described.

DESCRIPTION

FIG. 1 is a top, side and front perspective view of a cutlery handle with undulating line showing the new design;
 FIG. 2 is a top, side and front perspective view showing the handle used as a fork;
 FIG. 3 is a top, side and front perspective view showing the handle used as a spoon;
 FIG. 4 is a top, side and front perspective view showing the handle used as a knife;
 FIG. 5 is a right side elevation view thereof;
 FIG. 6 is a left side elevation view thereof;
 FIG. 7 is a rear elevation view thereof;
 FIG. 8 is a front elevation view thereof;
 FIG. 9 is a top plan view thereof; and,
 FIG. 10 is a bottom plan view thereof.

The broken line showing environmental structure is for illustrative purposes only and forms no part of the claimed design.

1 Claim, 4 Drawing Sheets

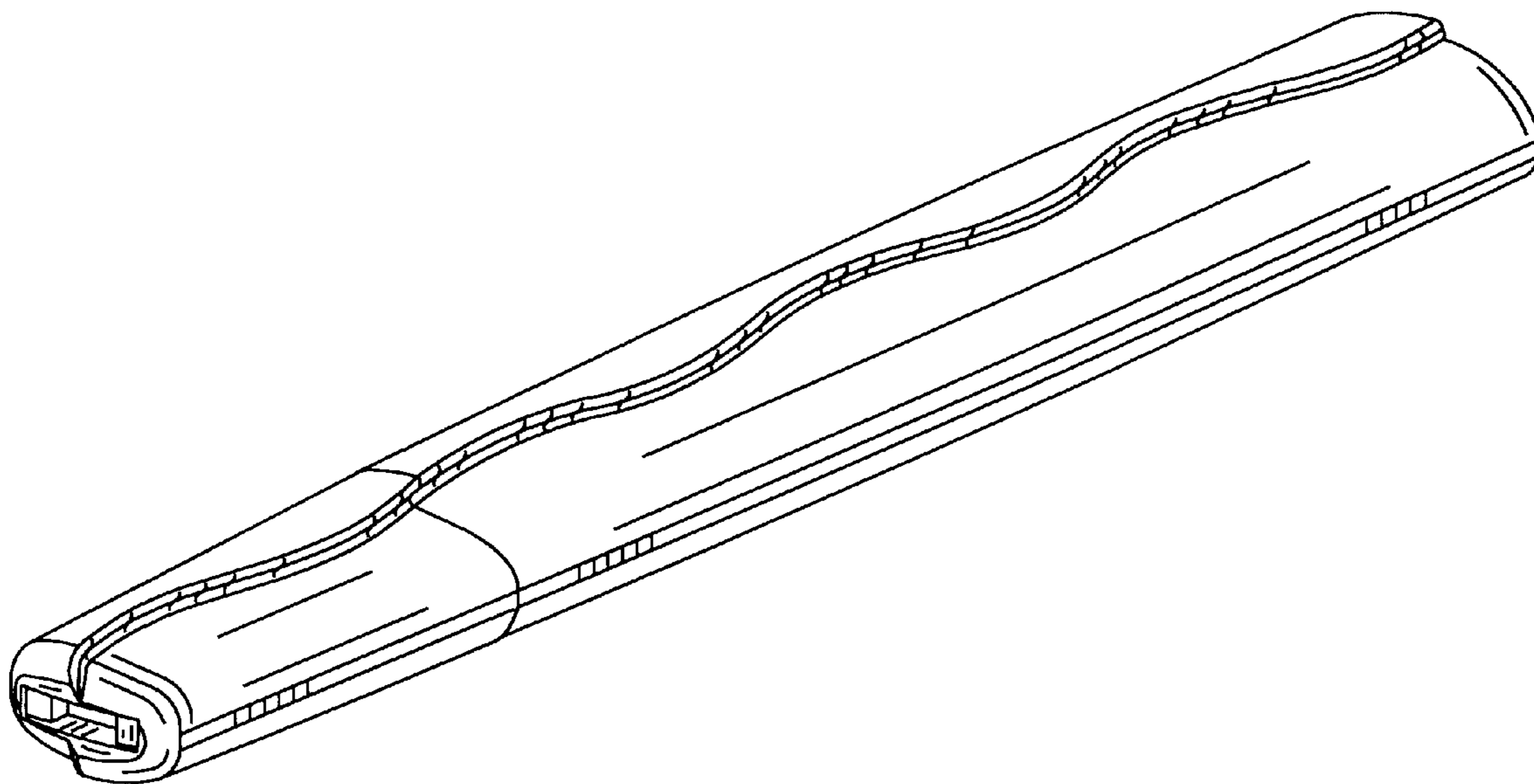

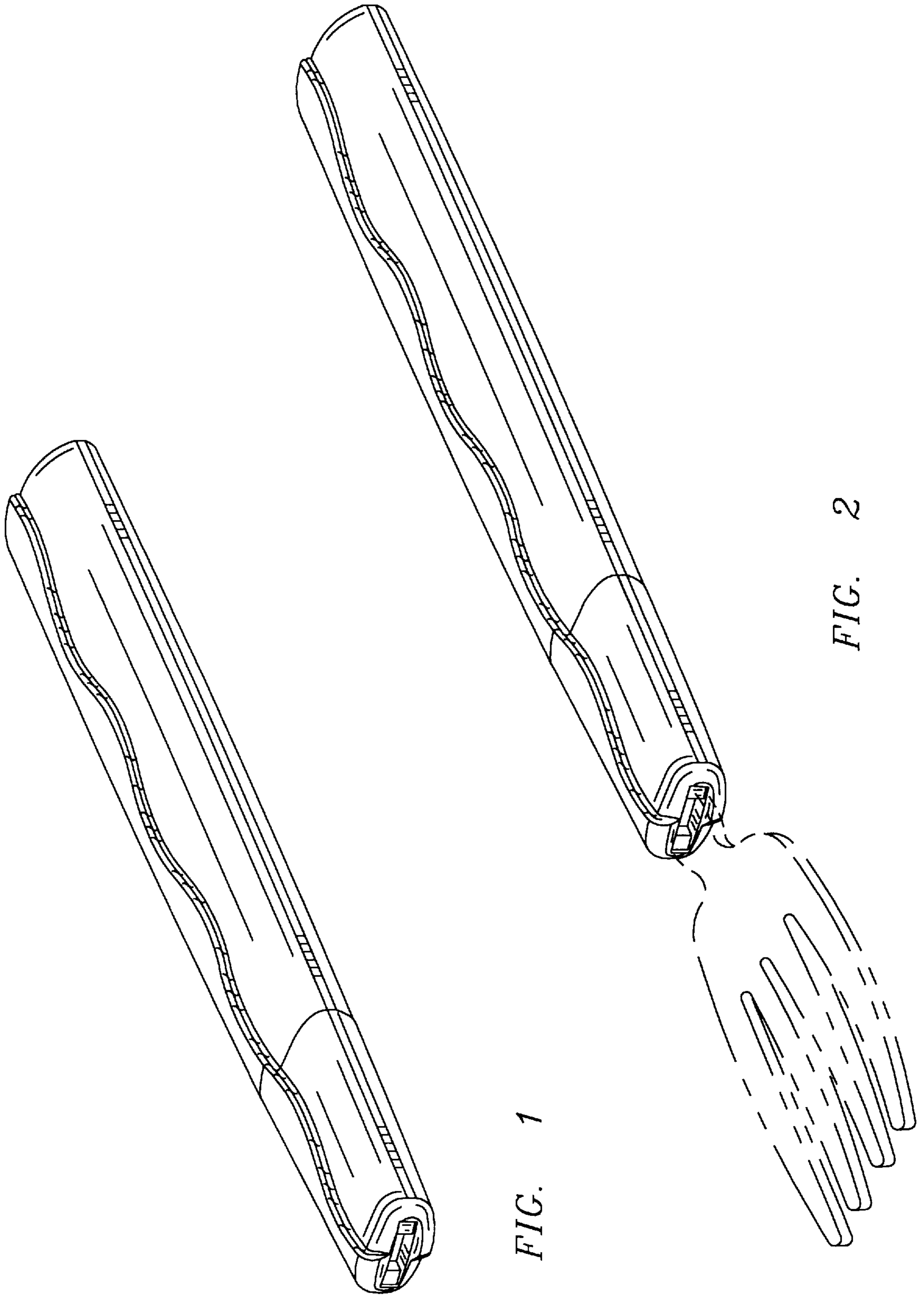

FIG. 1

FIG. 2

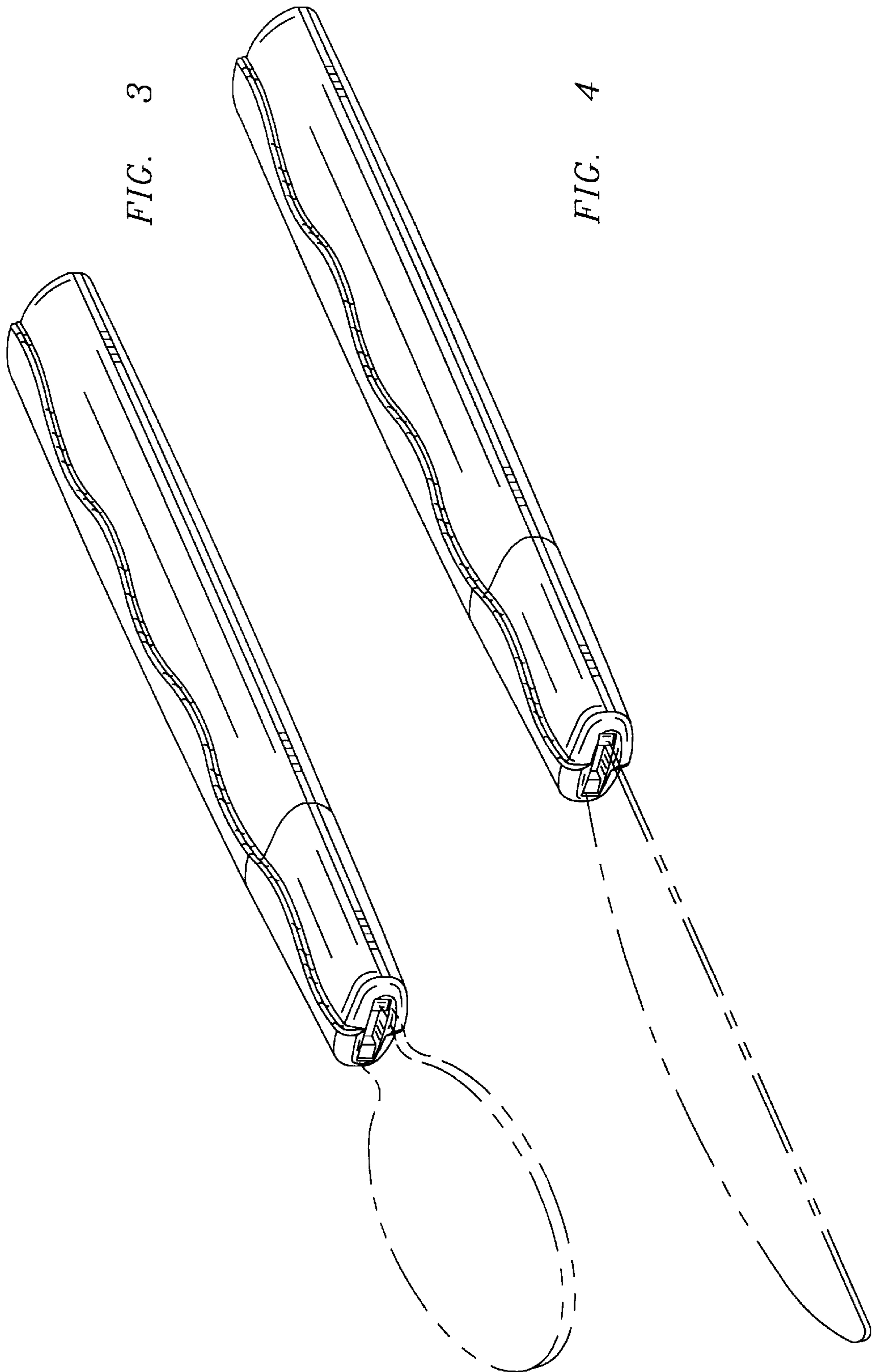

FIG. 3

FIG. 4



FIG. 5

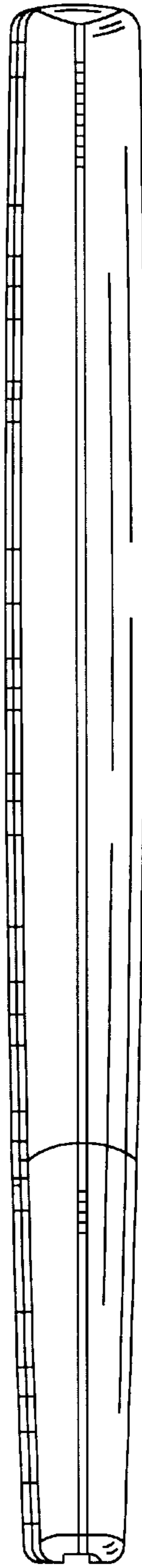

FIG. 6

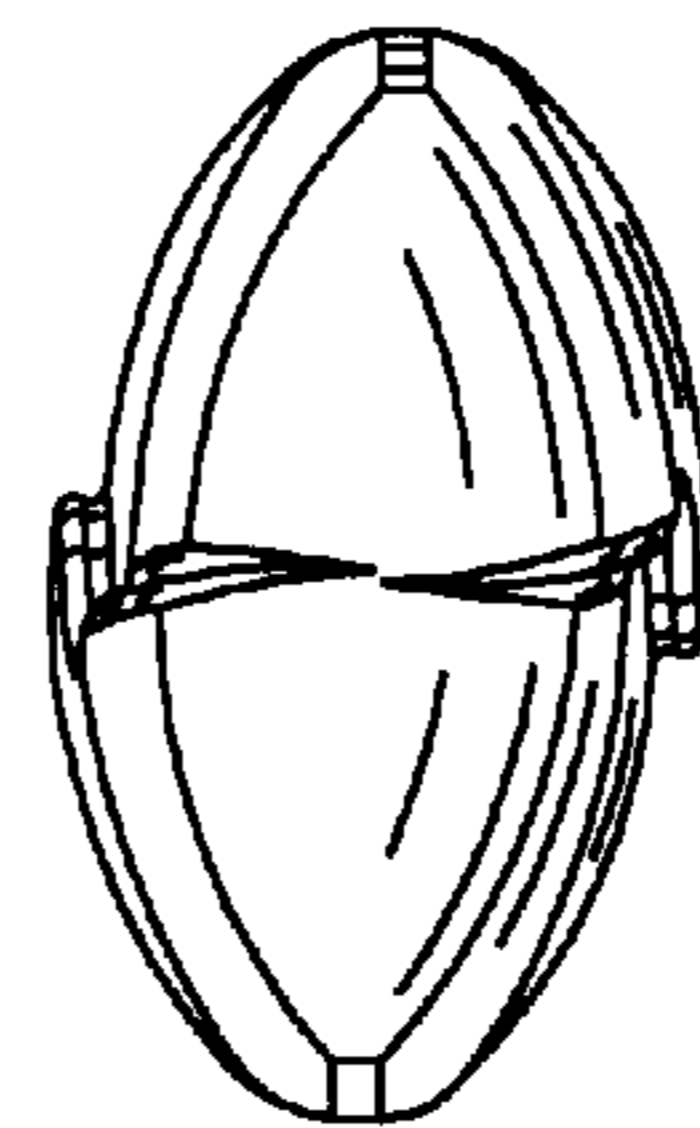

FIG. 7

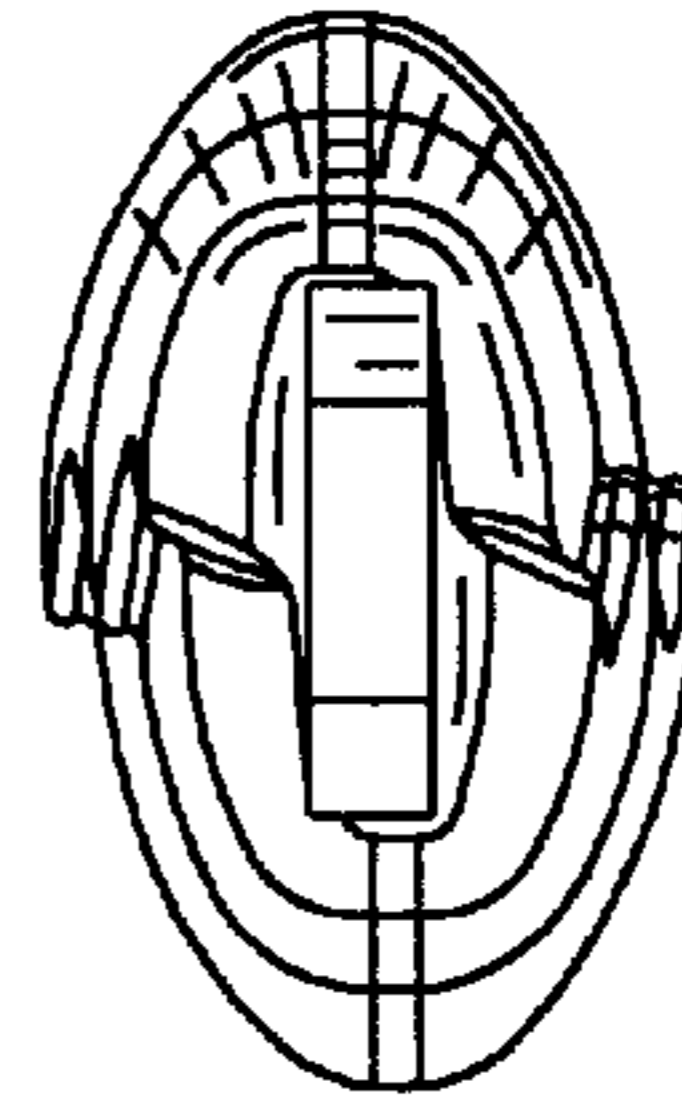

FIG. 8

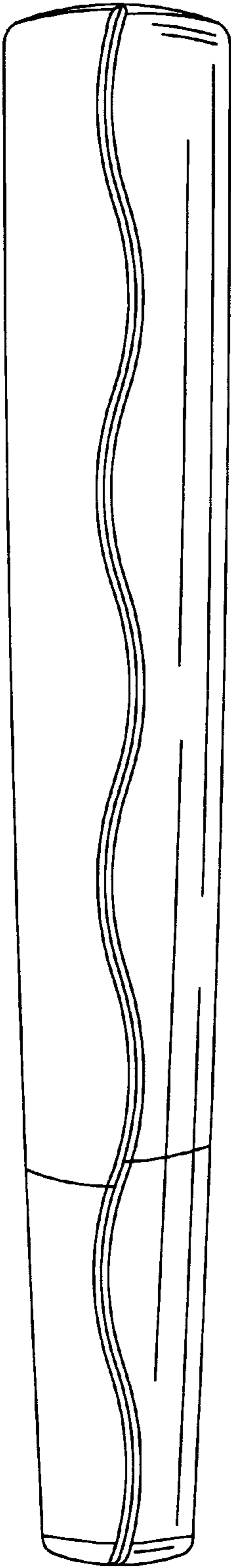

FIG. 9

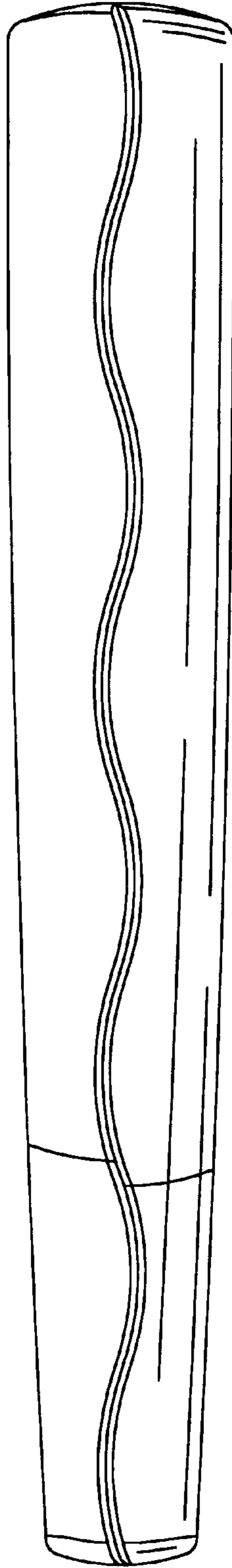

FIG. 10