



US00D428761S

United States Patent [19]

Noda et al.

[11] Patent Number: **Des. 428,761**

[45] Date of Patent: **** Aug. 1, 2000**

[54] **MICROWAVE OVEN**

[75] Inventors: **Kensaku Noda; Yasunori Kusachi,**
both of Shiga-Ken; **Masatoshi Okuda,**
Gunma-Ken; **Atsuko Kawamura,**
Shiga-Ken, all of Japan

[73] Assignee: **Sanyo Electric Co., Ltd.,** Moriguchi,
Japan

[**] Term: **14 Years**

[21] Appl. No.: **29/106,209**

[22] Filed: **Jun. 9, 1999**

[30] **Foreign Application Priority Data**

Dec. 26, 1998 [JP] Japan 10-38031

[51] **LOC (7) Cl.** **07-02**

[52] **U.S. Cl.** **D7/351**

[58] **Field of Search** D7/350-351, 402;
126/273 R, 273 A, 275 R, 275 E, 19 M,
21 A; 219/678, 680, 756-758

[56] **References Cited**

U.S. PATENT DOCUMENTS

D. 261,468 10/1981 Takahashi et al. D7/351

D. 266,641 10/1982 Yamamura et al. D7/351
D. 268,080 3/1983 Haruguchi et al. D7/351
D. 283,671 5/1986 Miyake et al. D7/351
D. 289,965 5/1987 Choi D7/351
D. 294,554 3/1988 Song D7/351
D. 295,488 5/1988 Kido et al. D7/351

Primary Examiner—Ruth McInroy
Attorney, Agent, or Firm—Darby & Darby

[57] **CLAIM**

We claim the ornamental design for a microwave oven, as shown and described.

DESCRIPTION

FIG. 1 is a top, front, and right side perspective view of a microwave oven showing our new design;
FIG. 2 is a top plan view of our new design;
FIG. 3 is a front elevation view thereof;
FIG. 4 is a right side elevation view thereof;
FIG. 5 is a left side elevation view thereof;
FIG. 6 is a rear elevation view thereof; and,
FIG. 7 is a bottom plan view thereof.

1 Claim, 4 Drawing Sheets

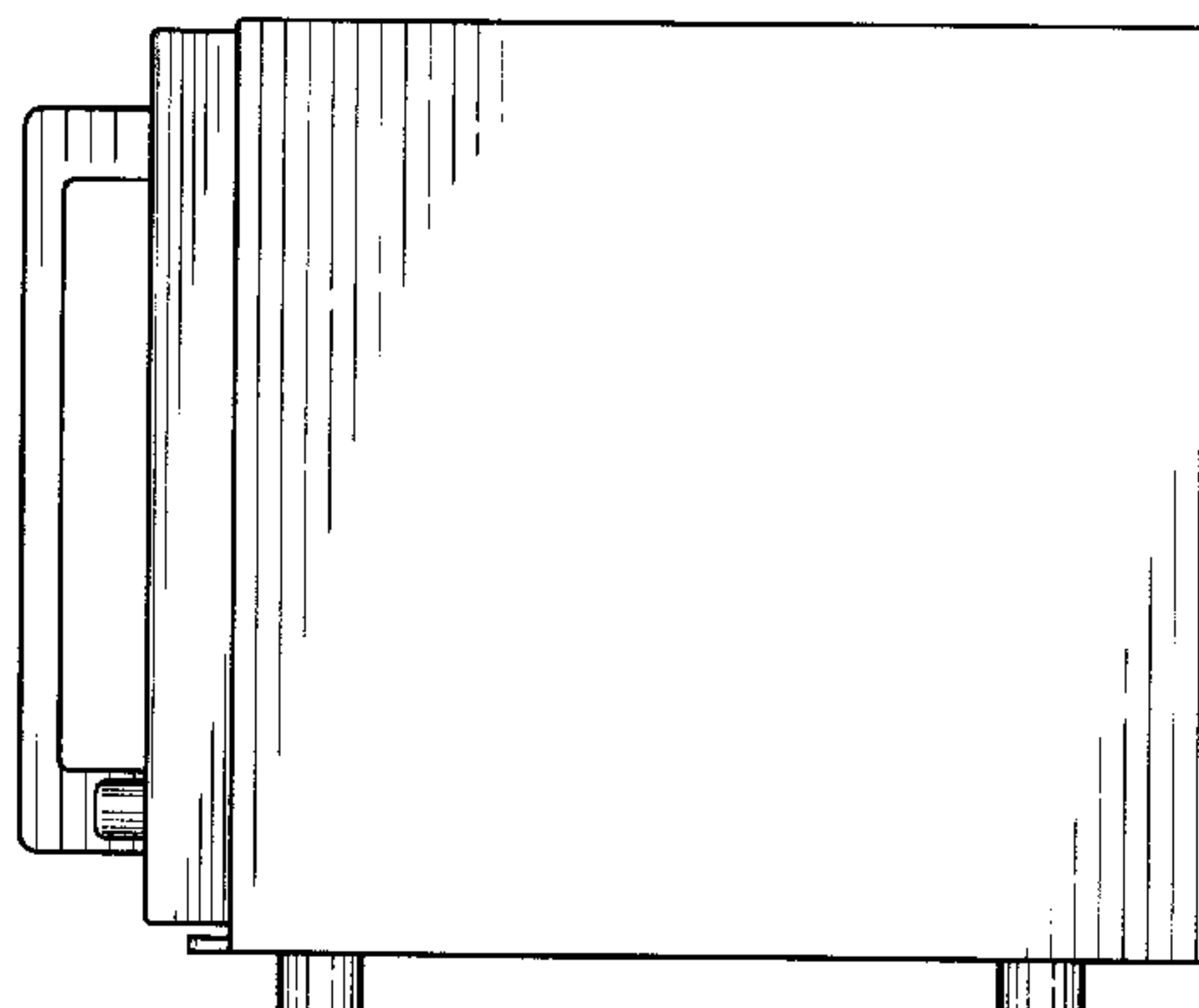
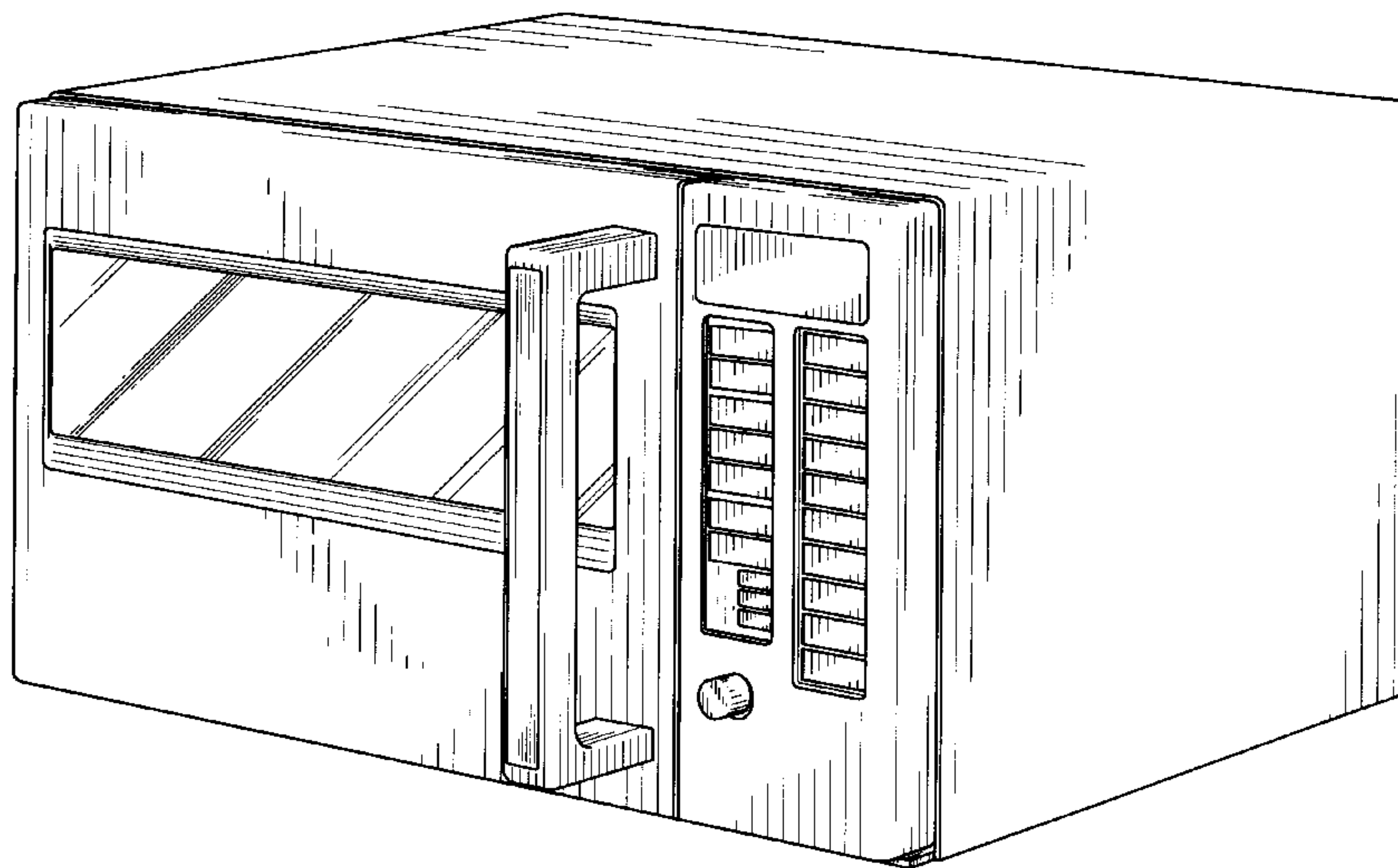

FIG. 1

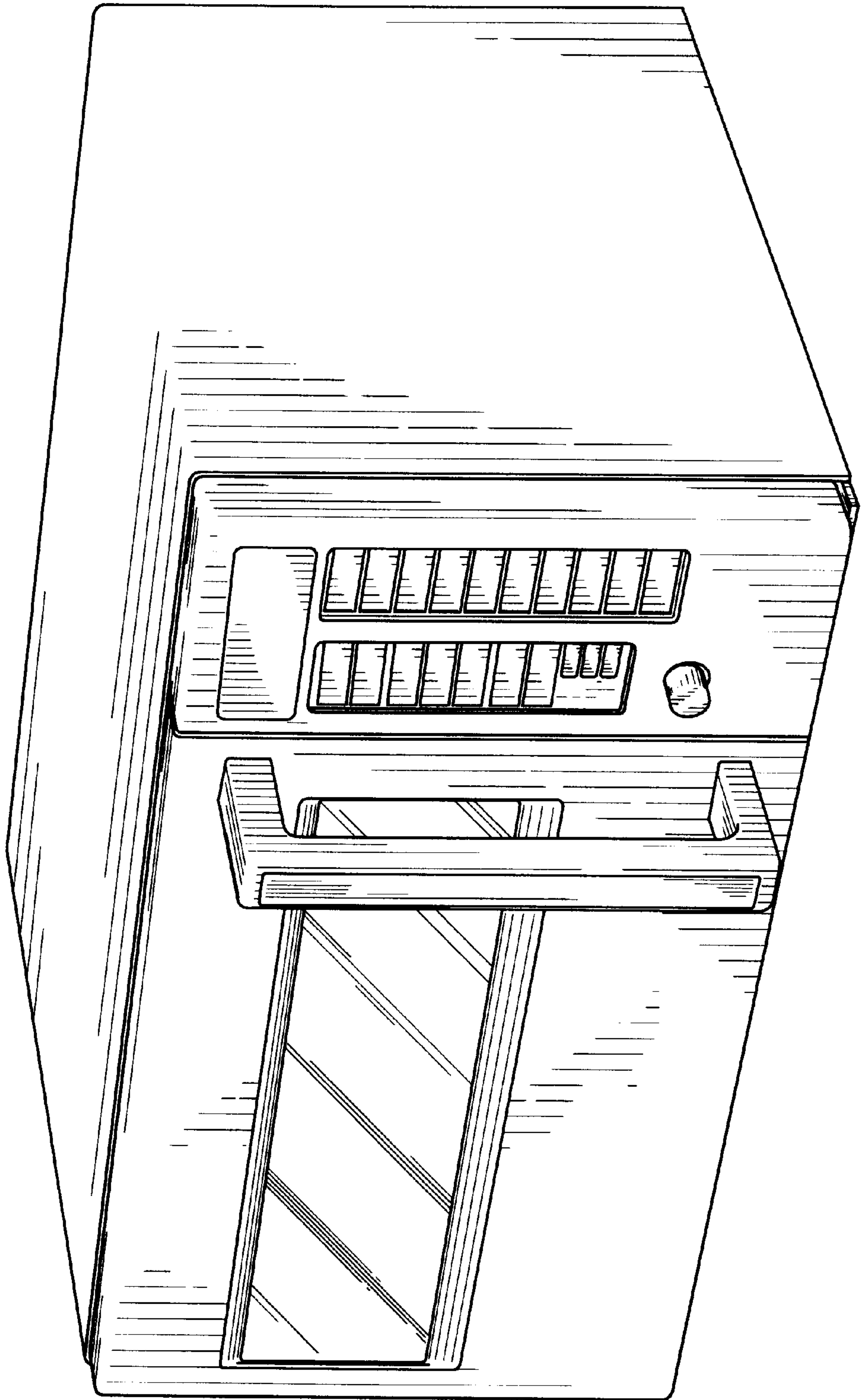

FIG. 2

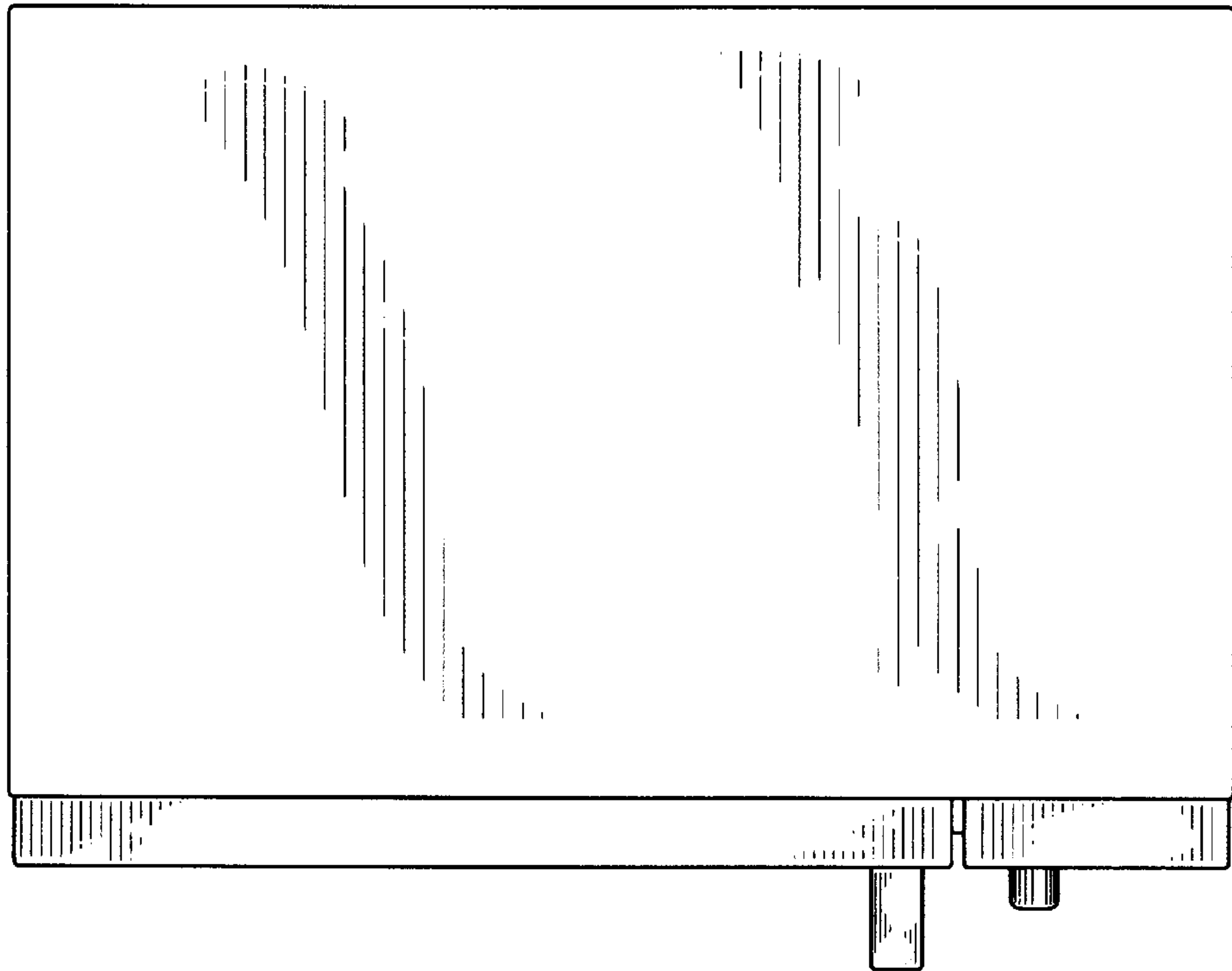

FIG. 3

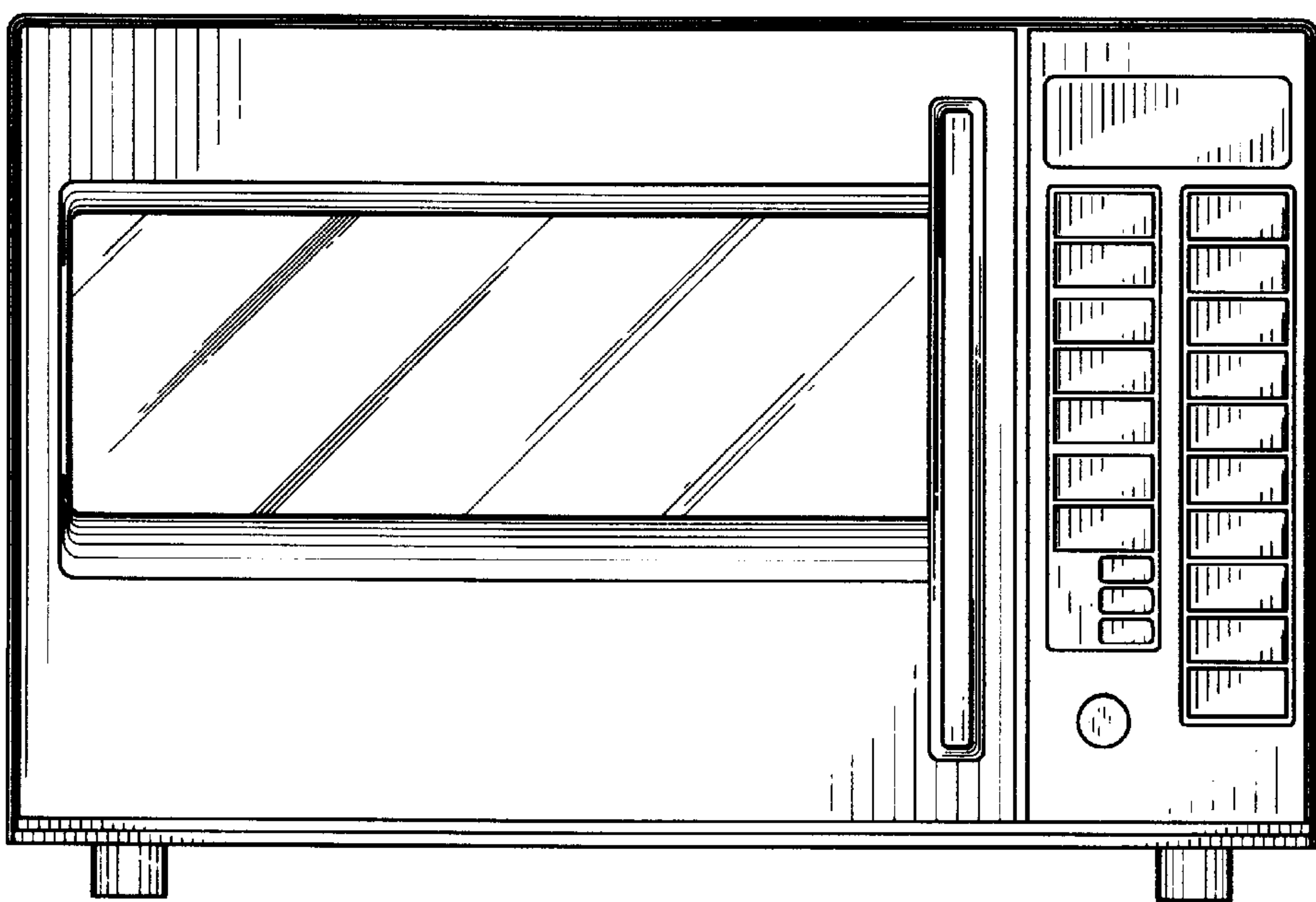

FIG. 4

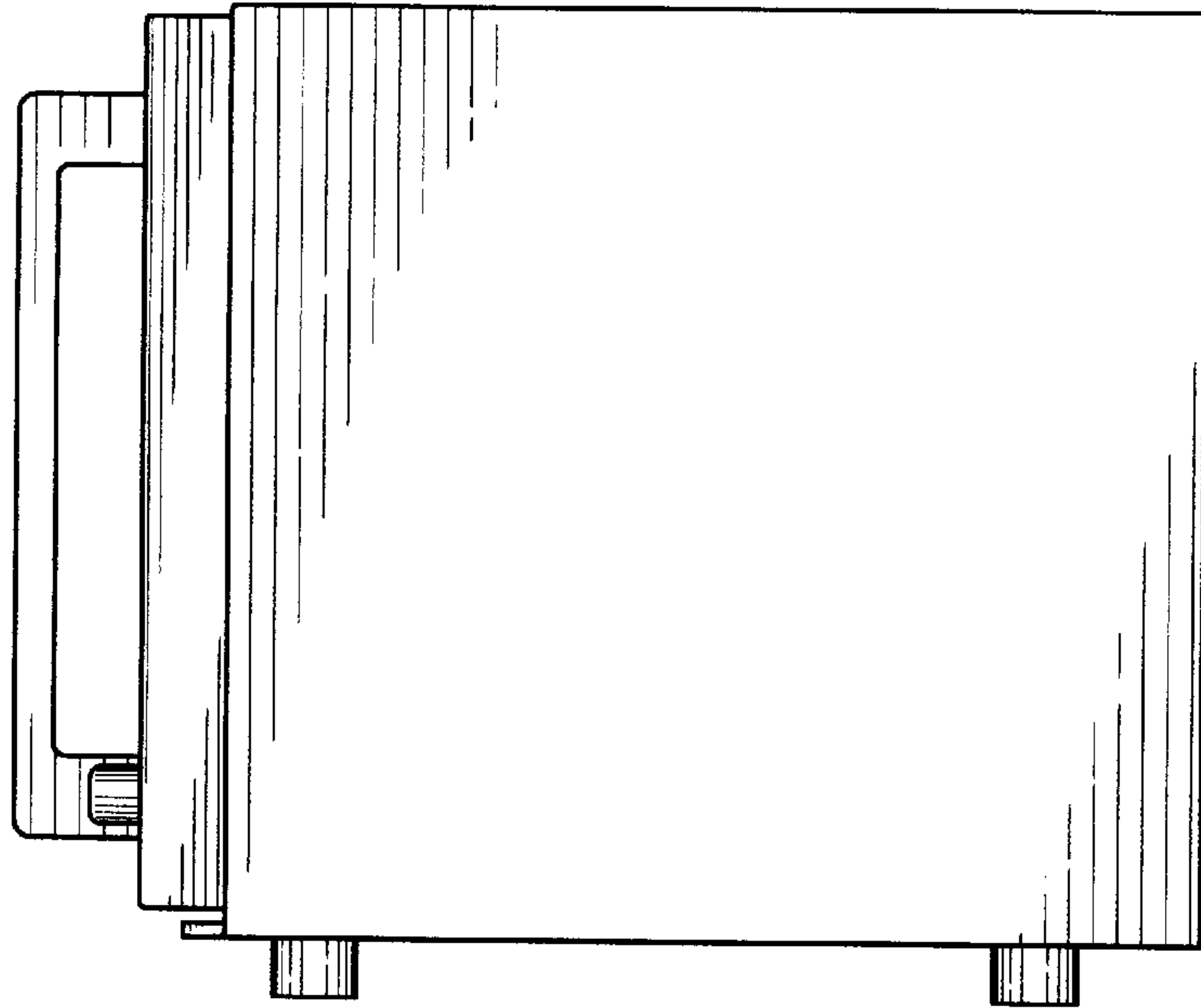

FIG. 5

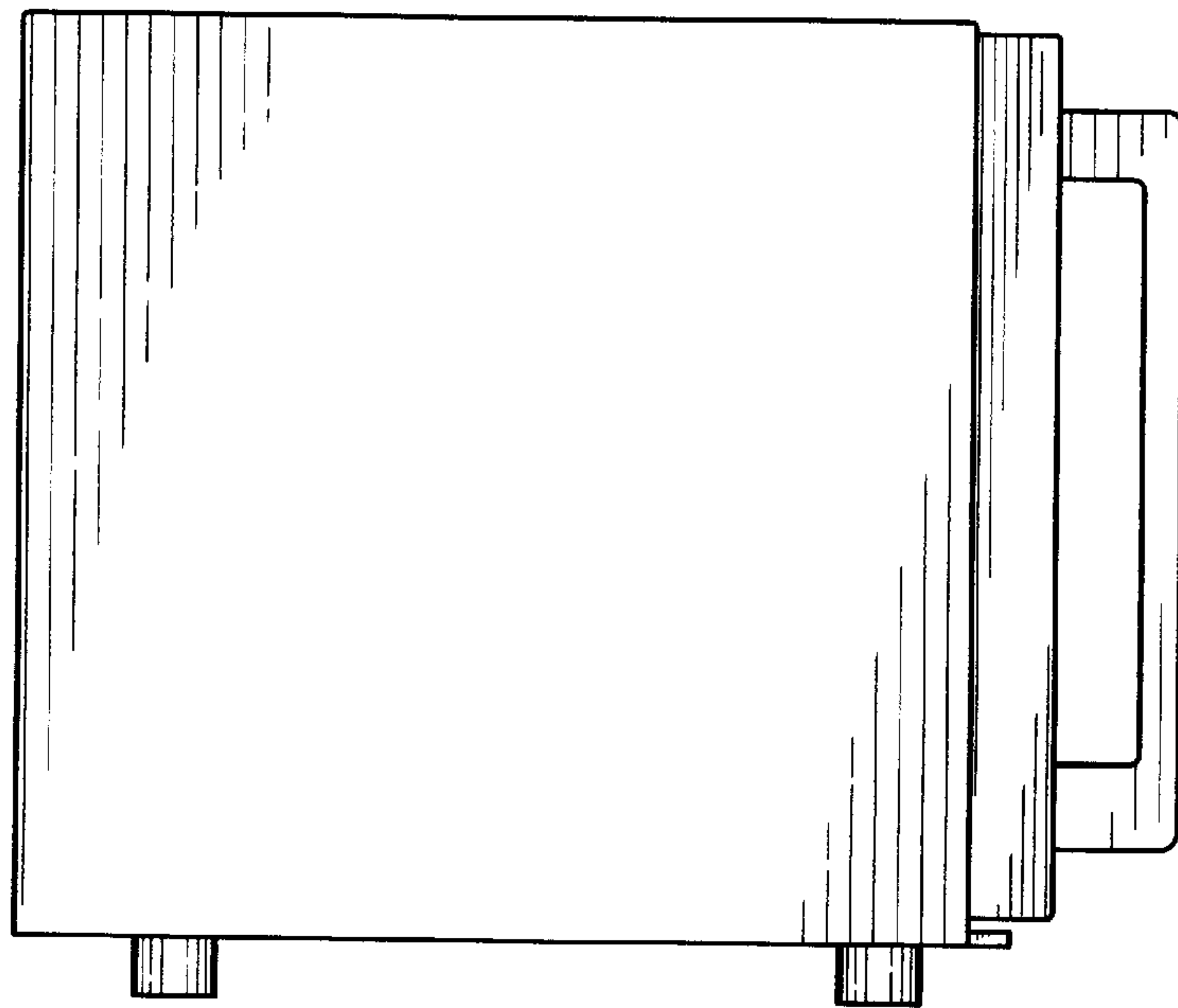

FIG. 6

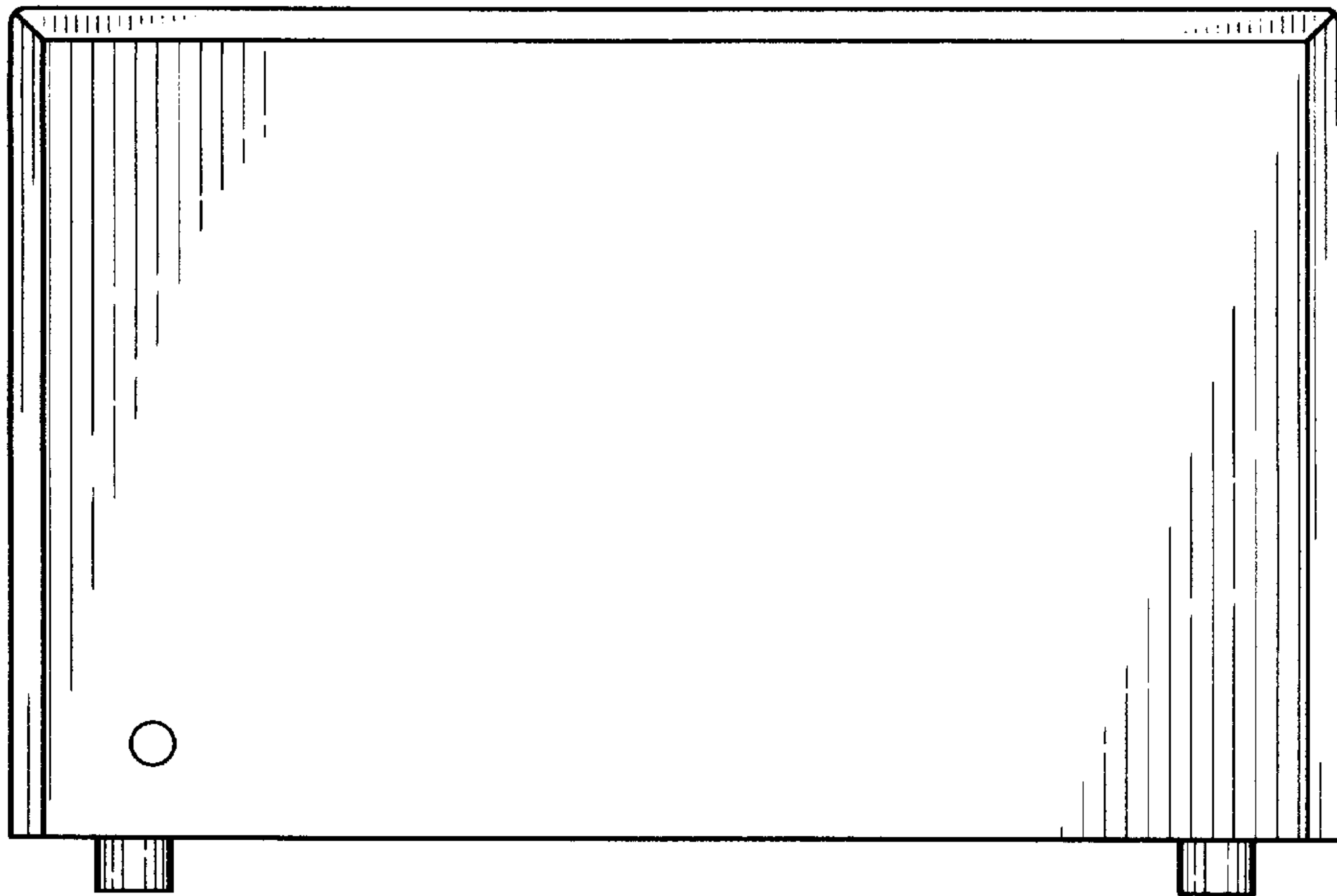

FIG. 7

