



US00D428760S

United States Patent [19] Huang

[11] Patent Number: **Des. 428,760**

[45] Date of Patent: **** Aug. 1, 2000**

[54] **BARBEQUE GRILL**

[76] Inventor: **Kuo-Chin Huang**, 1st Fl., No. 161,
Wan-Sheng St., Taipei, Taiwan

[**] Term: **14 Years**

[21] Appl. No.: **29/102,278**

[22] Filed: **Mar. 22, 1999**

[51] **LOC (7) Cl.** **07-02**

[52] **U.S. Cl.** **D7/334**

[58] **Field of Search** D7/332-337, 402-404,
D7/409; 126/25 R, 25 A, 25 AA, 29-30,
9 R, 9 B, 39 R, 41 R, 38; 99/421 R

[56] **References Cited**

U.S. PATENT DOCUMENTS

- D. 315,079 3/1991 Jui-Yen D7/334
- D. 351,308 10/1994 Pai D7/334
- D. 381,241 7/1997 Pai D7/334

- D. 381,860 8/1997 Chiang D7/334
- D. 409,436 5/1999 Smith D7/334
- 5,111,802 5/1992 Lin 126/25 R

Primary Examiner—Ruth McInroy
Attorney, Agent, or Firm—Kirkpatrick & Lockhart LLP

[57] **CLAIM**

The ornamental design for a barbeque grill, as shown.

DESCRIPTION

FIG. 1 is a perspective view of a barbeque grill showing my new design;
FIG. 2 is a front view thereof;
FIG. 3 is a rear view thereof;
FIG. 4 is a left side view thereof;
FIG. 5 is a right side view thereof;
FIG. 6 is a top view thereof; and,
FIG. 7 is a bottom view thereof.

1 Claim, 6 Drawing Sheets

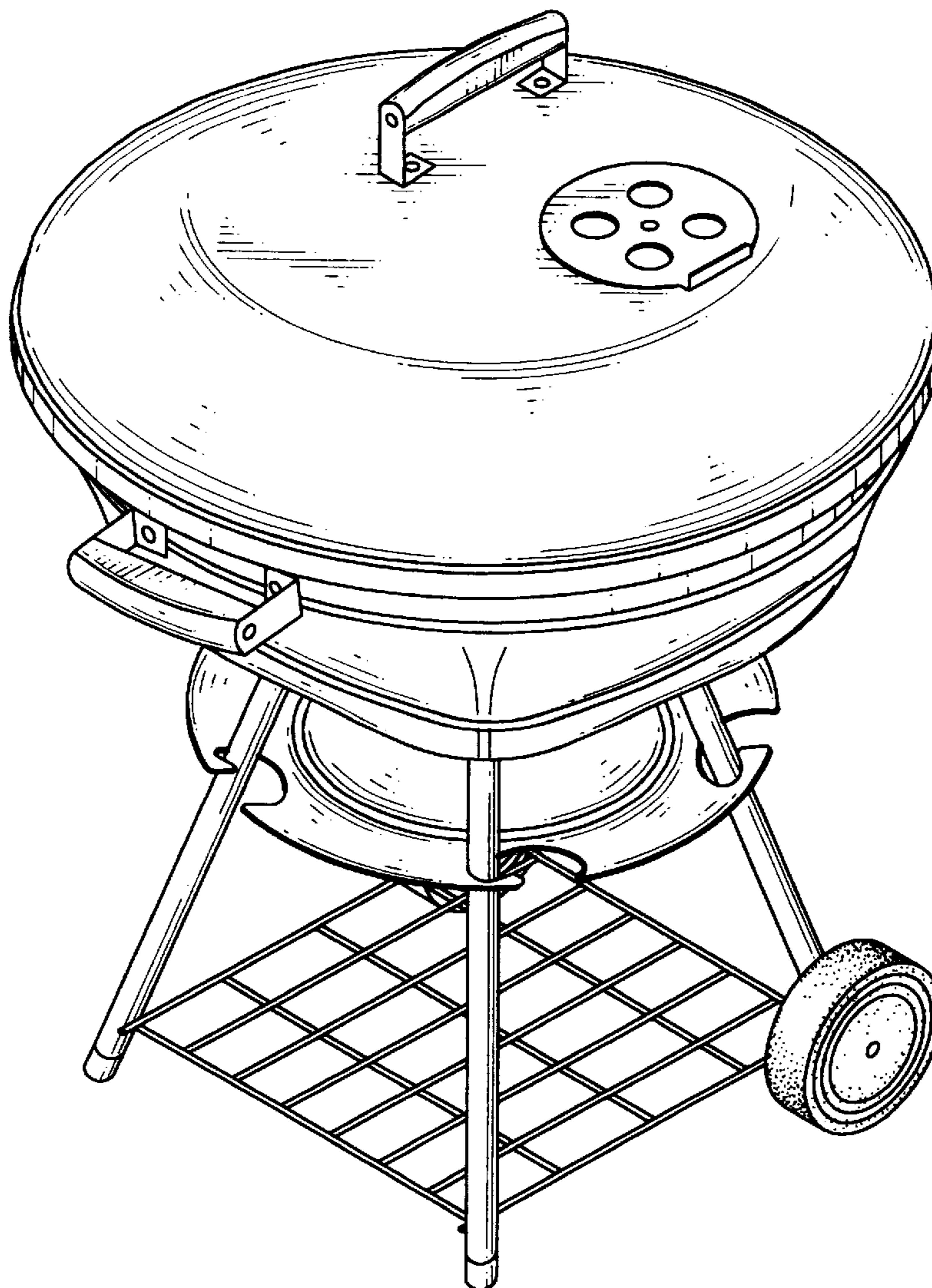

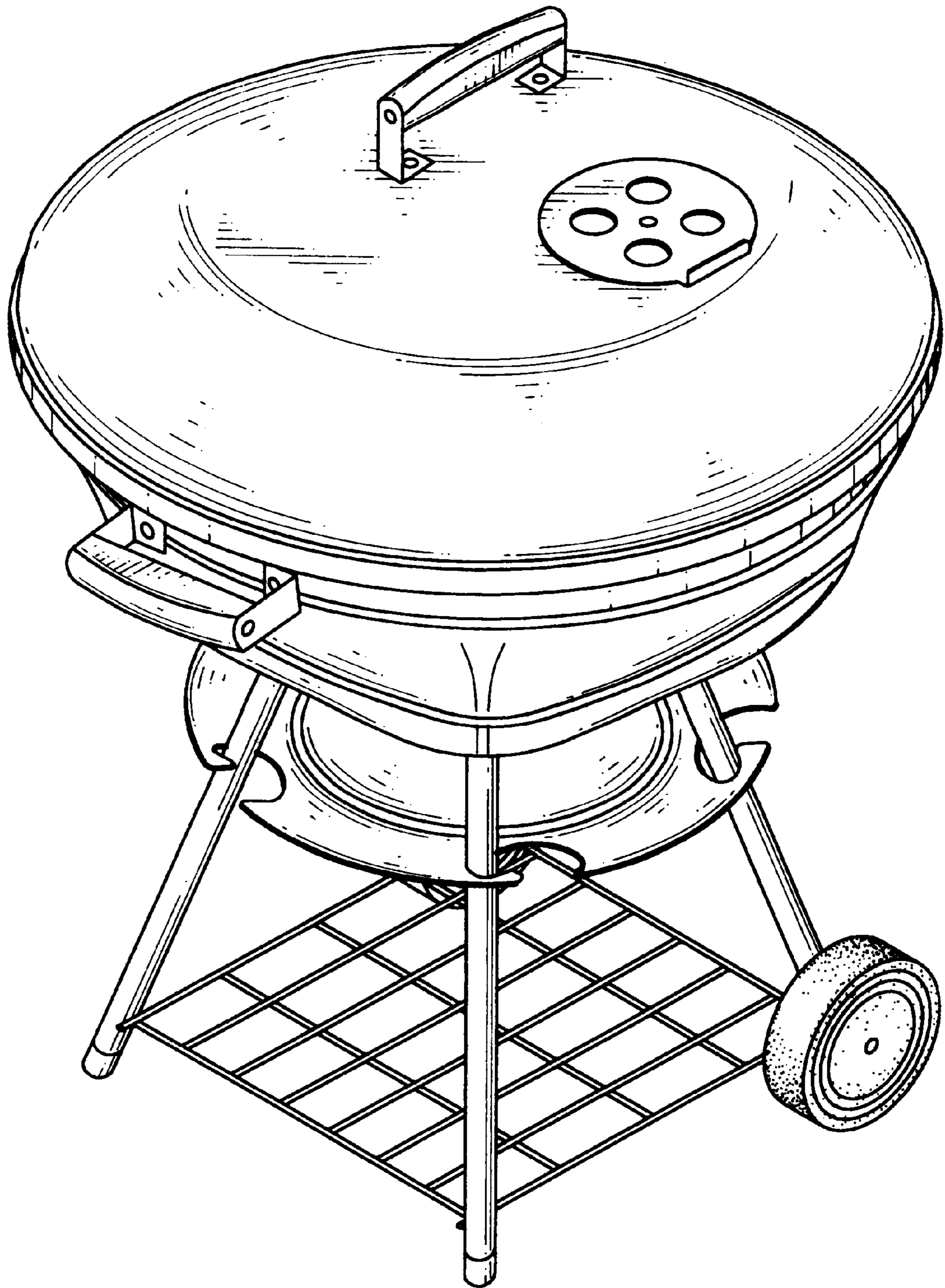

FIG. 1

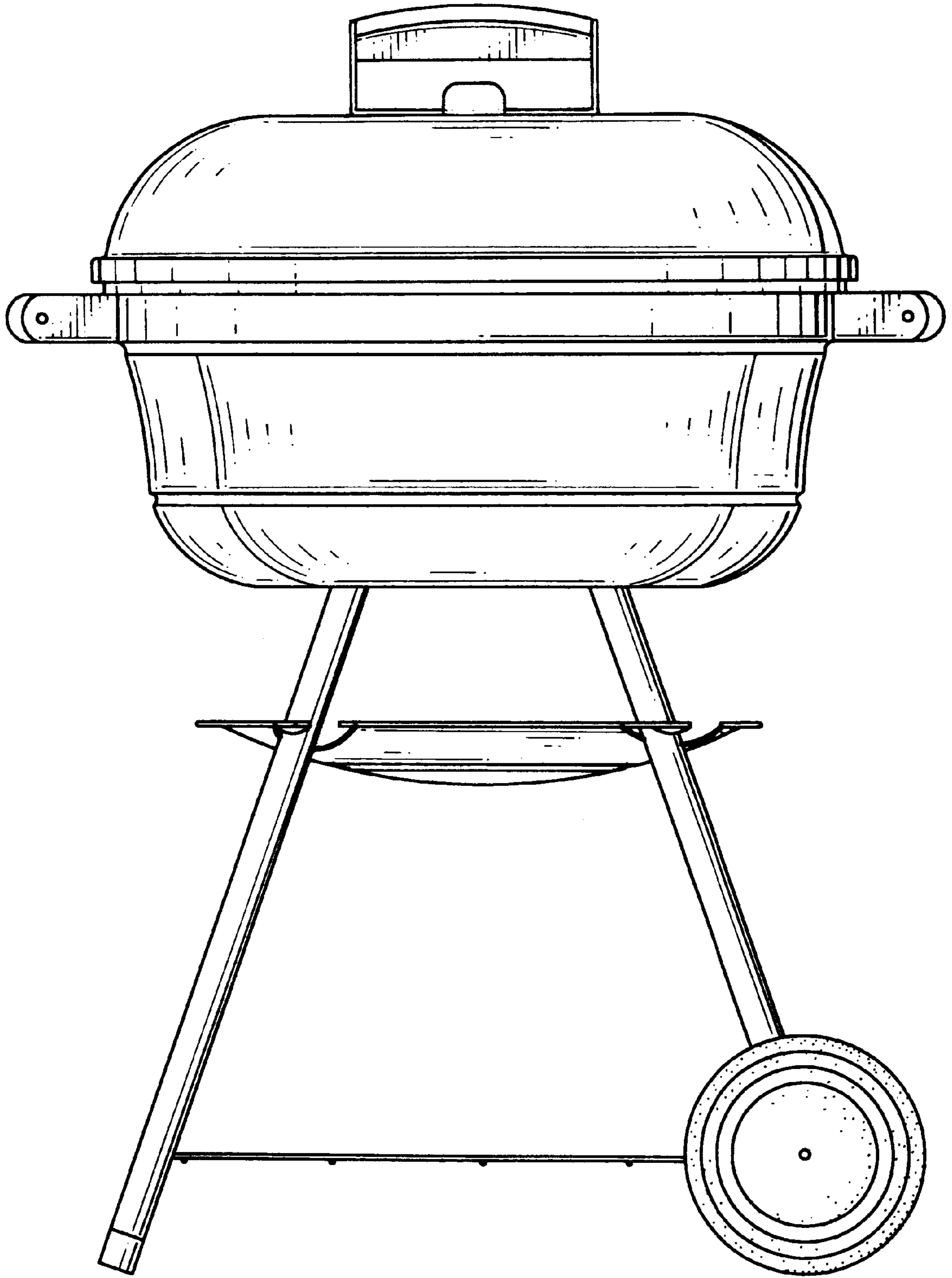

FIG. 2

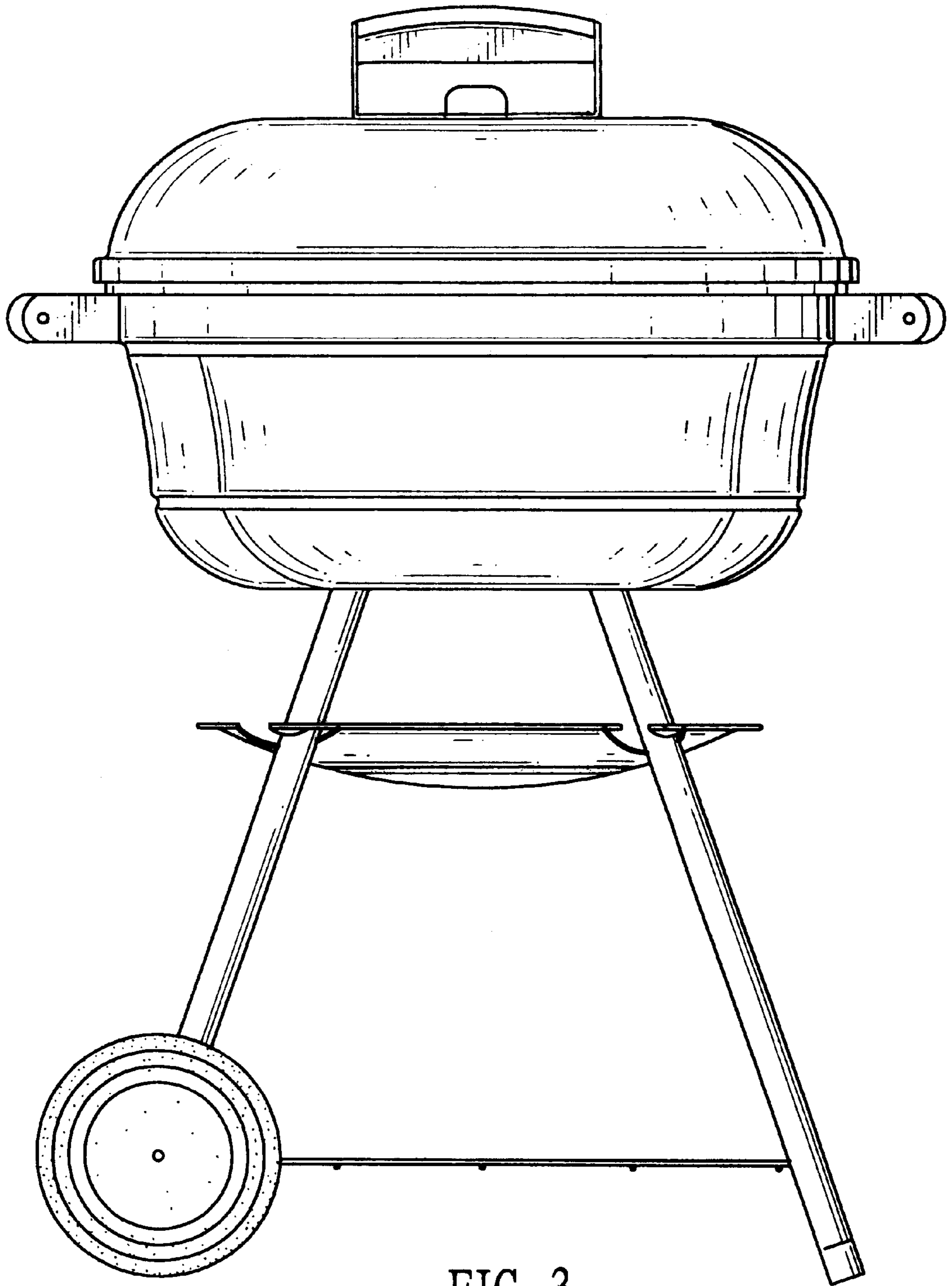

FIG. 3

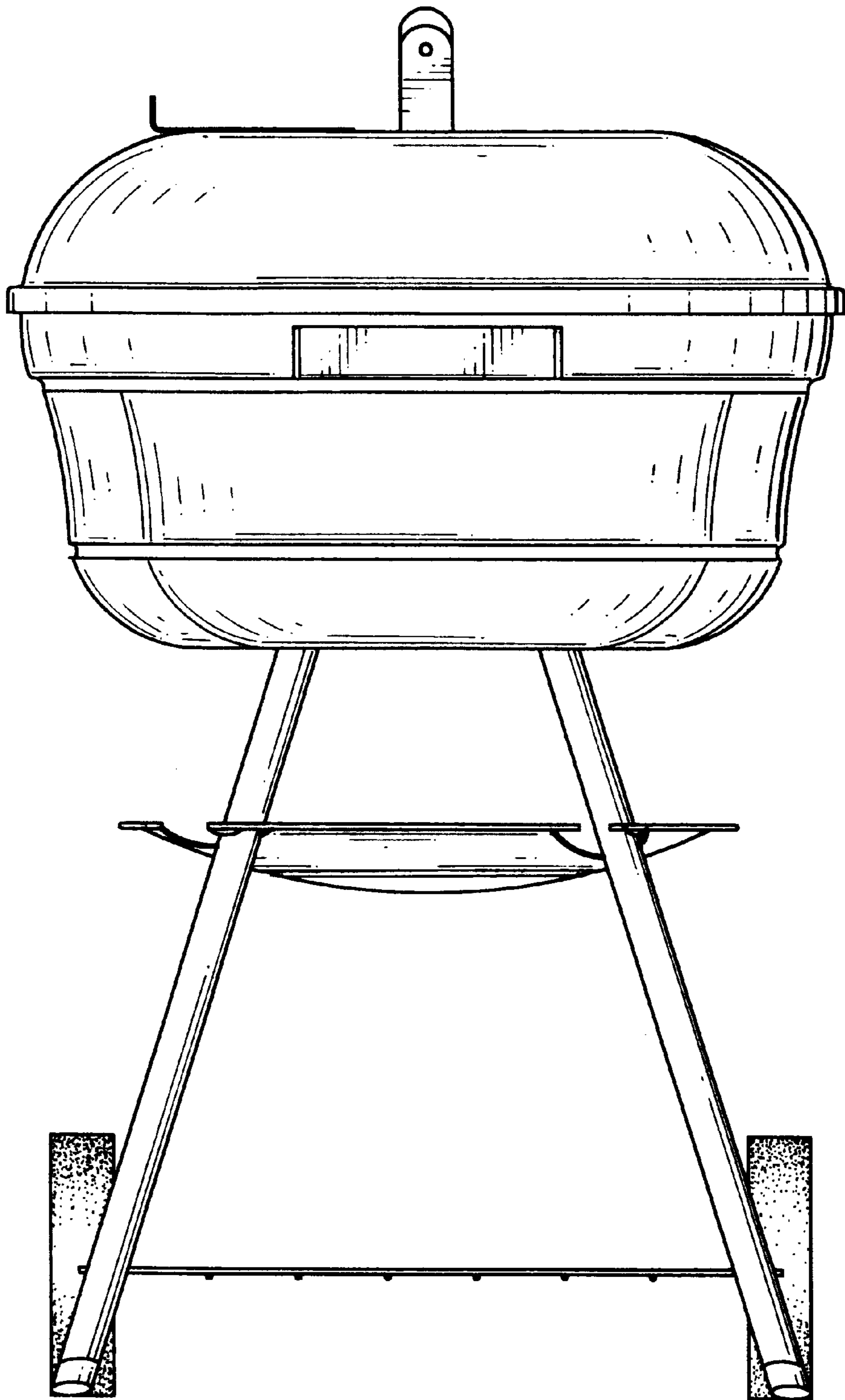

FIG. 4

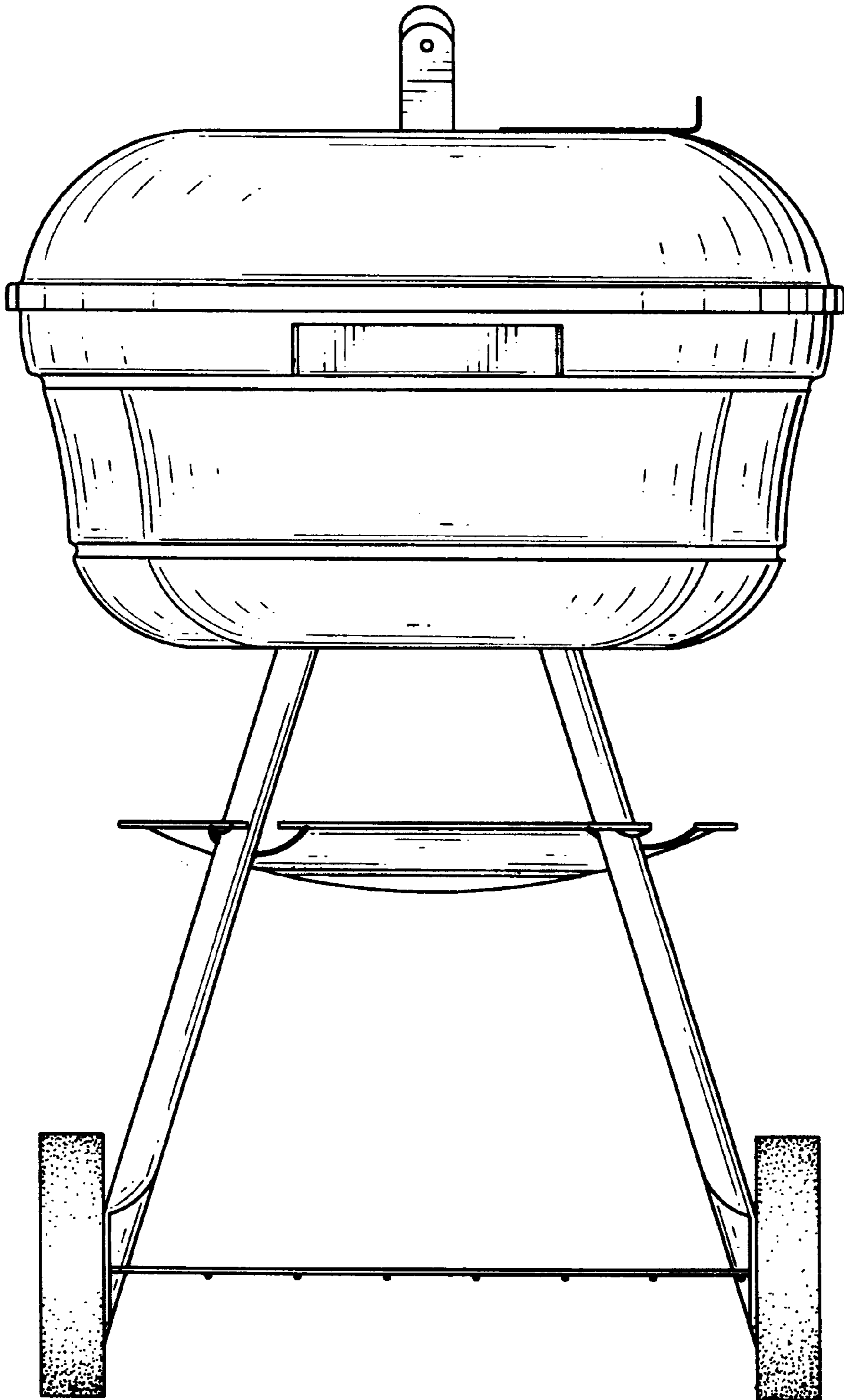

FIG. 5

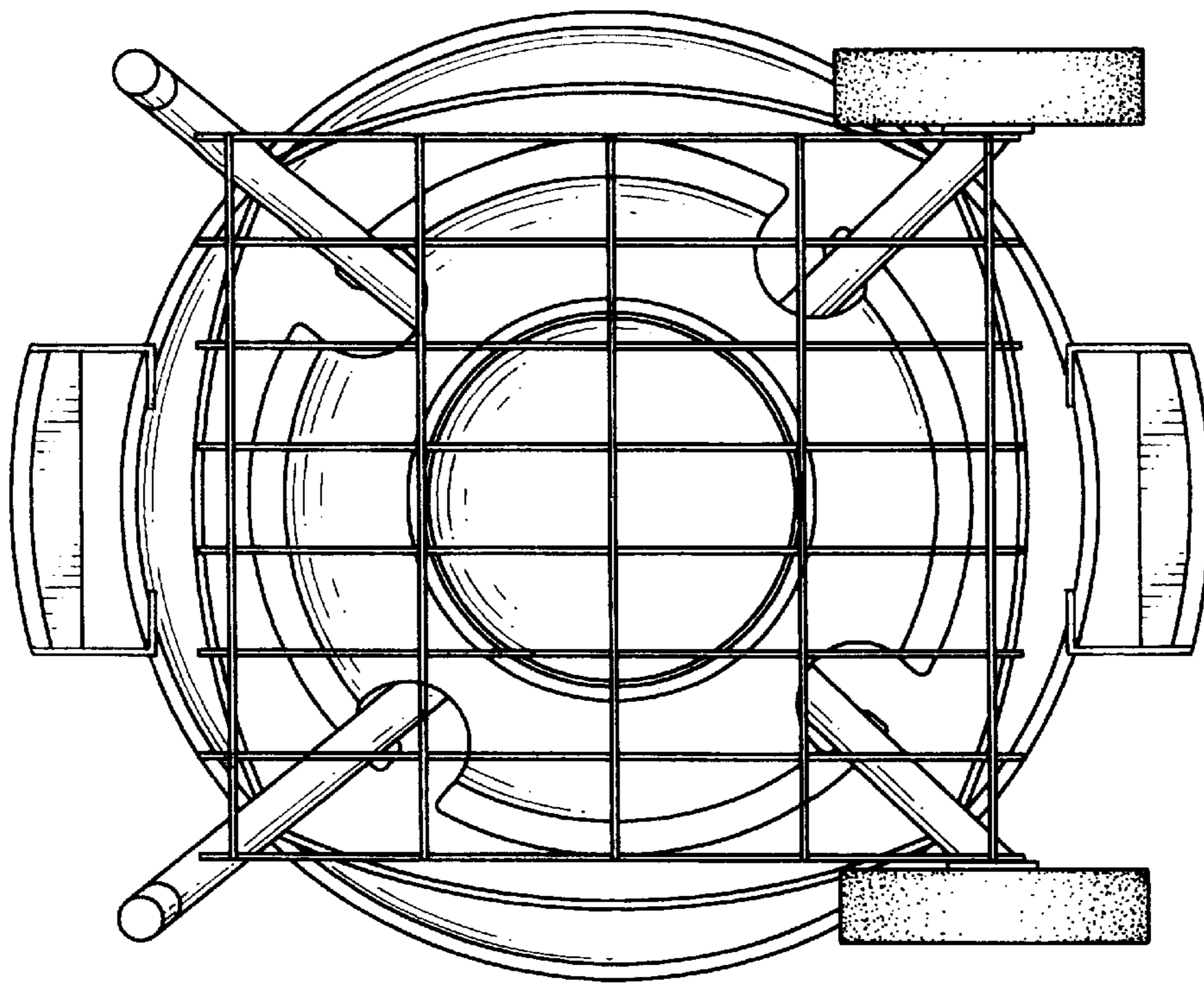

FIG. 7

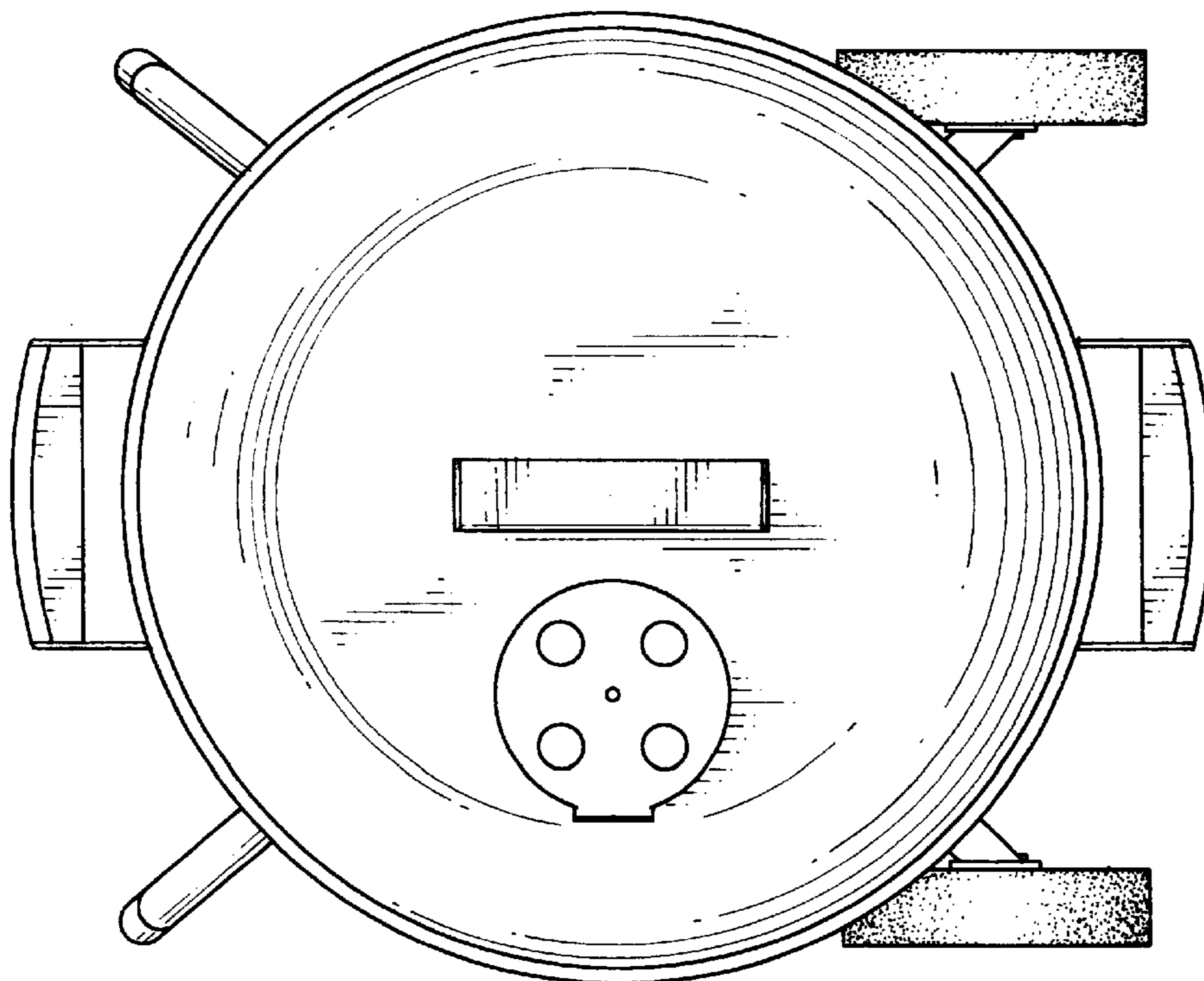

FIG. 6