



US00D428744S

United States Patent [19]
Patel et al.

[11] **Patent Number: Des. 428,744**
[45] **Date of Patent: ** Aug. 1, 2000**

- [54] **WIRE SHOWER ORGANIZER**
- [75] Inventors: **Shailesh Patel**, Glenview; **Lawrence Hauser**, Chicago, both of Ill.
- [73] Assignee: **Home Products International, Inc.**, Chicago, Ill.
- [**] Term: **14 Years**
- [21] Appl. No.: **29/117,944**
- [22] Filed: **Feb. 2, 2000**
- [51] **LOC (7) Cl.** **23-02**
- [52] **U.S. Cl.** **D6/525**
- [58] **Field of Search** D6/524, 525, 566;
211/13.1, 86, 87, 106, 113, 119, 126.1,
134, 181.1; 248/206.3, 309.1

- D. 377,286 1/1997 Munoz D6/525
- D. 387,595 12/1997 Whang D6/525
- D. 400,745 11/1998 France D6/525
- D. 417,809 12/1999 Hofman D6/525
- 5,039,046 8/1991 Brewster 249/206.3

Primary Examiner—Brian N. Vinson
Attorney, Agent, or Firm—Rockey, Milnamow & Katz, Ltd.

[57] **CLAIM**

The ornamental design for a wire shower organizer, as shown and described.

DESCRIPTION

FIG. 1 is a perspective view of a wire shower organizer showing our new design, the suction cups shown in phantom lines not forming part of the invention; FIG. 2 is a top plan view thereof; FIG. 3 is a front elevational view thereof; FIG. 4 is a left side elevational view thereof; FIG. 5 is a right side elevational view thereof; FIG. 6 is a bottom plan view thereof; and, FIG. 7 is a rear elevational view thereof.

- [56] **References Cited**
- U.S. PATENT DOCUMENTS
- D. 320,134 9/1991 Emery D6/525
- D. 376,942 12/1996 Munoz D6/525

1 Claim, 2 Drawing Sheets

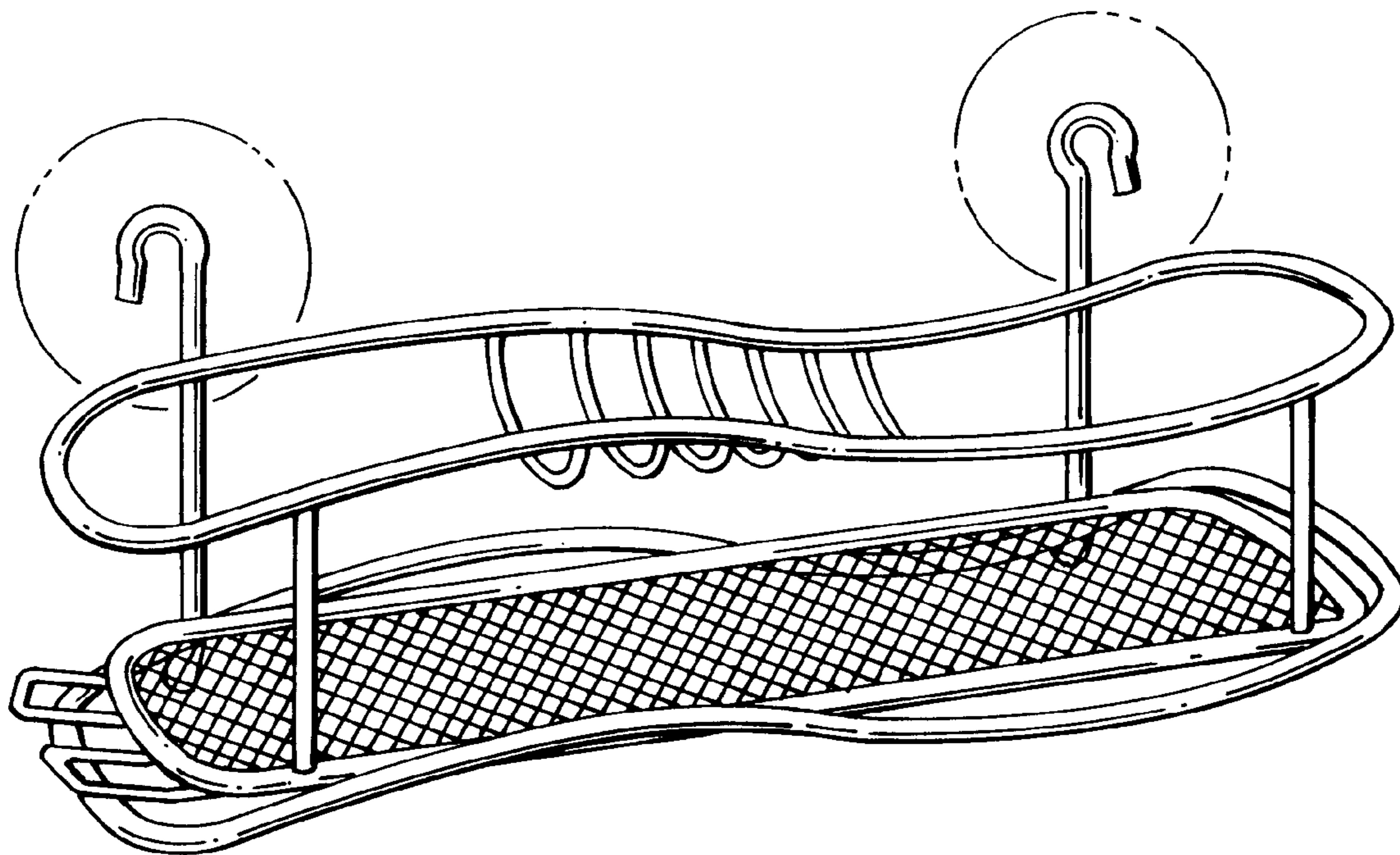

FIG. 1

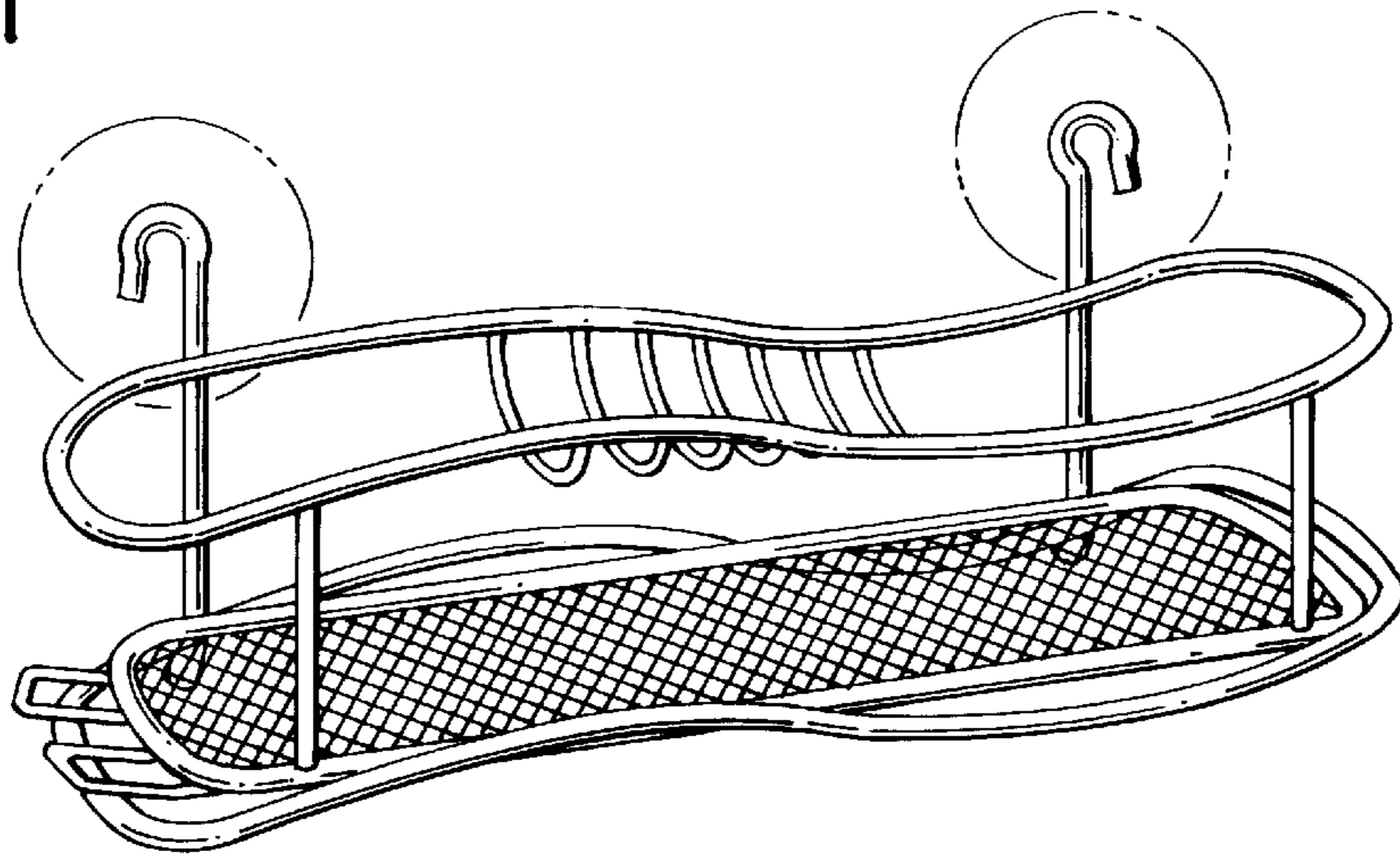

FIG. 2

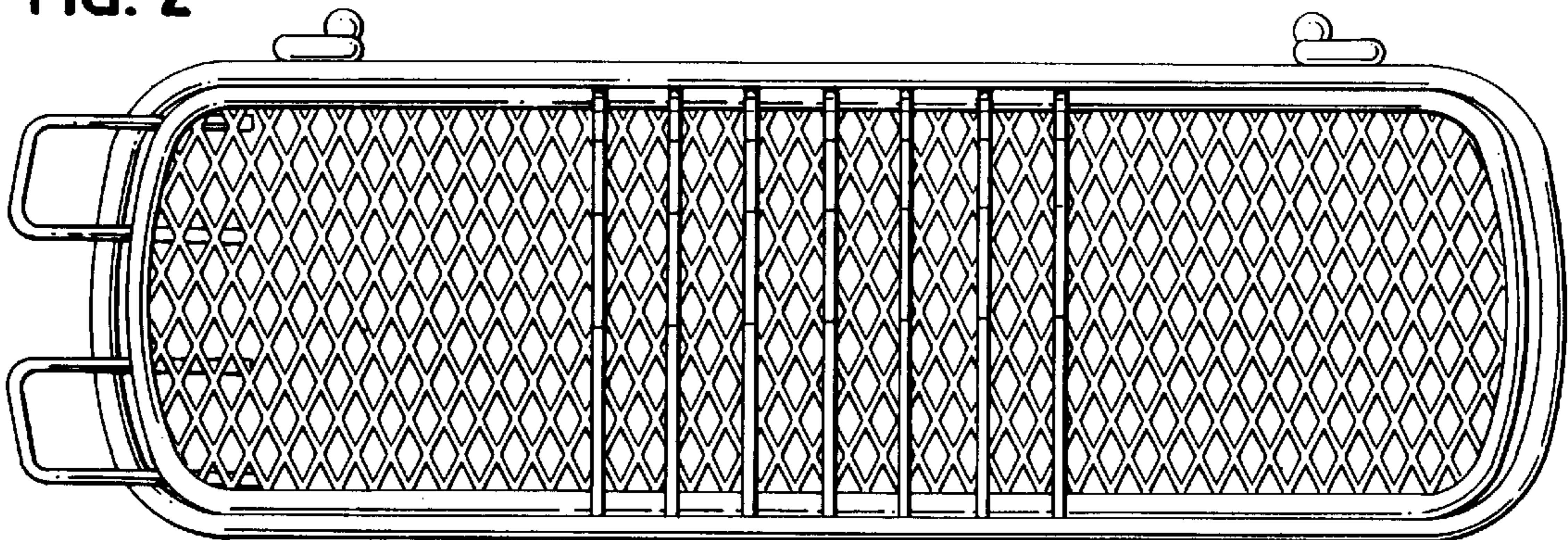

FIG. 3

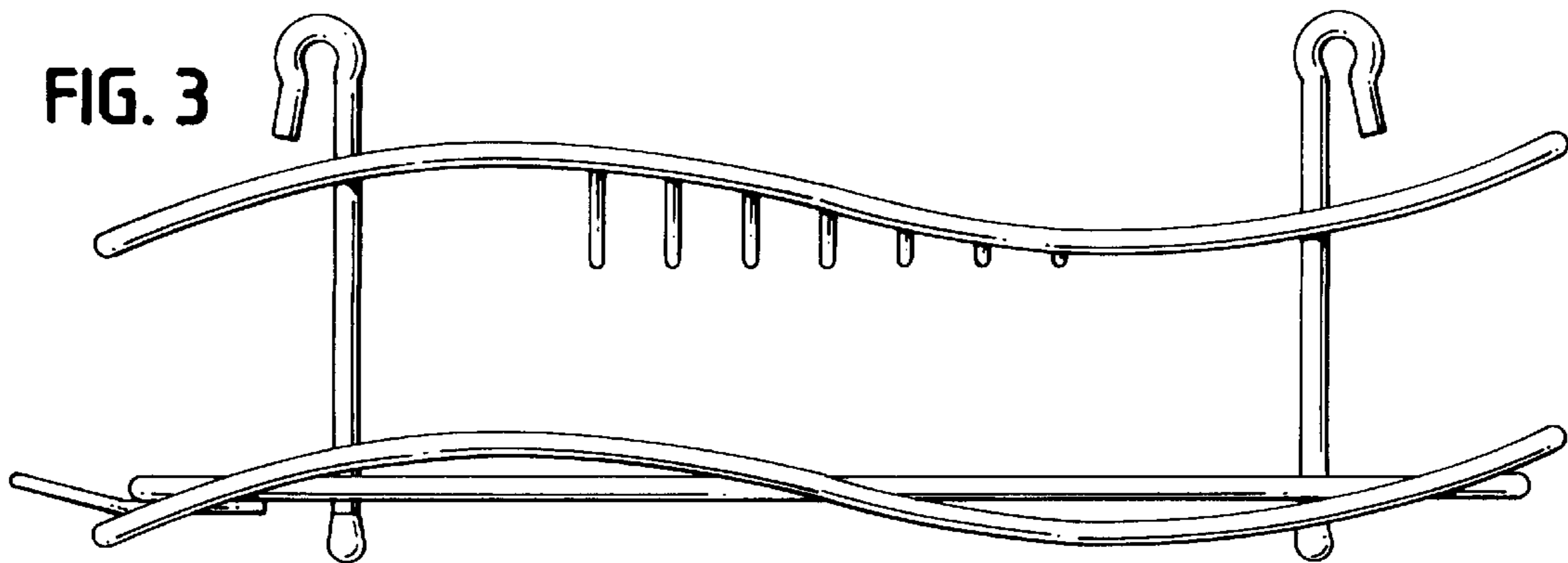

FIG. 4

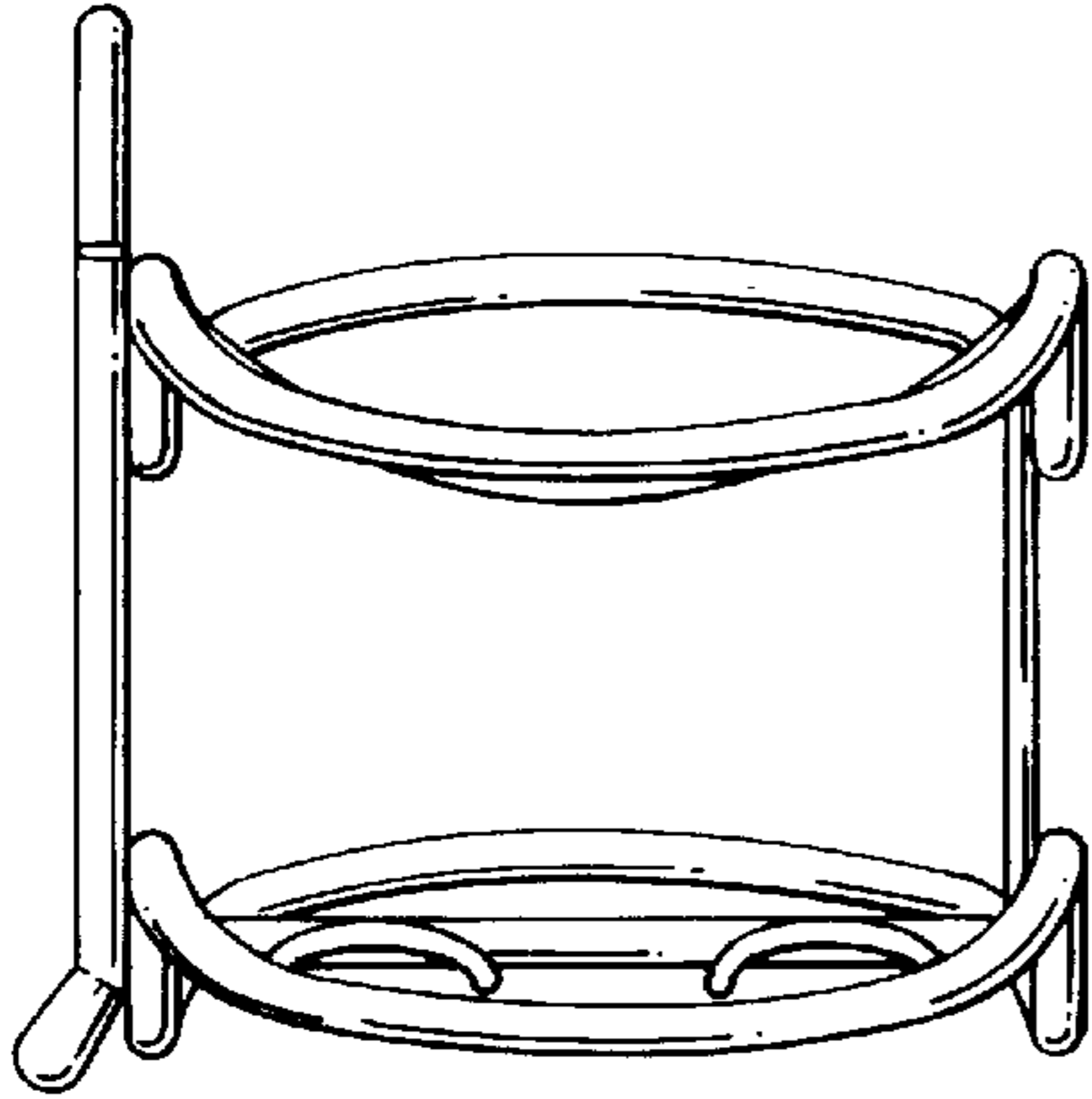

FIG. 5

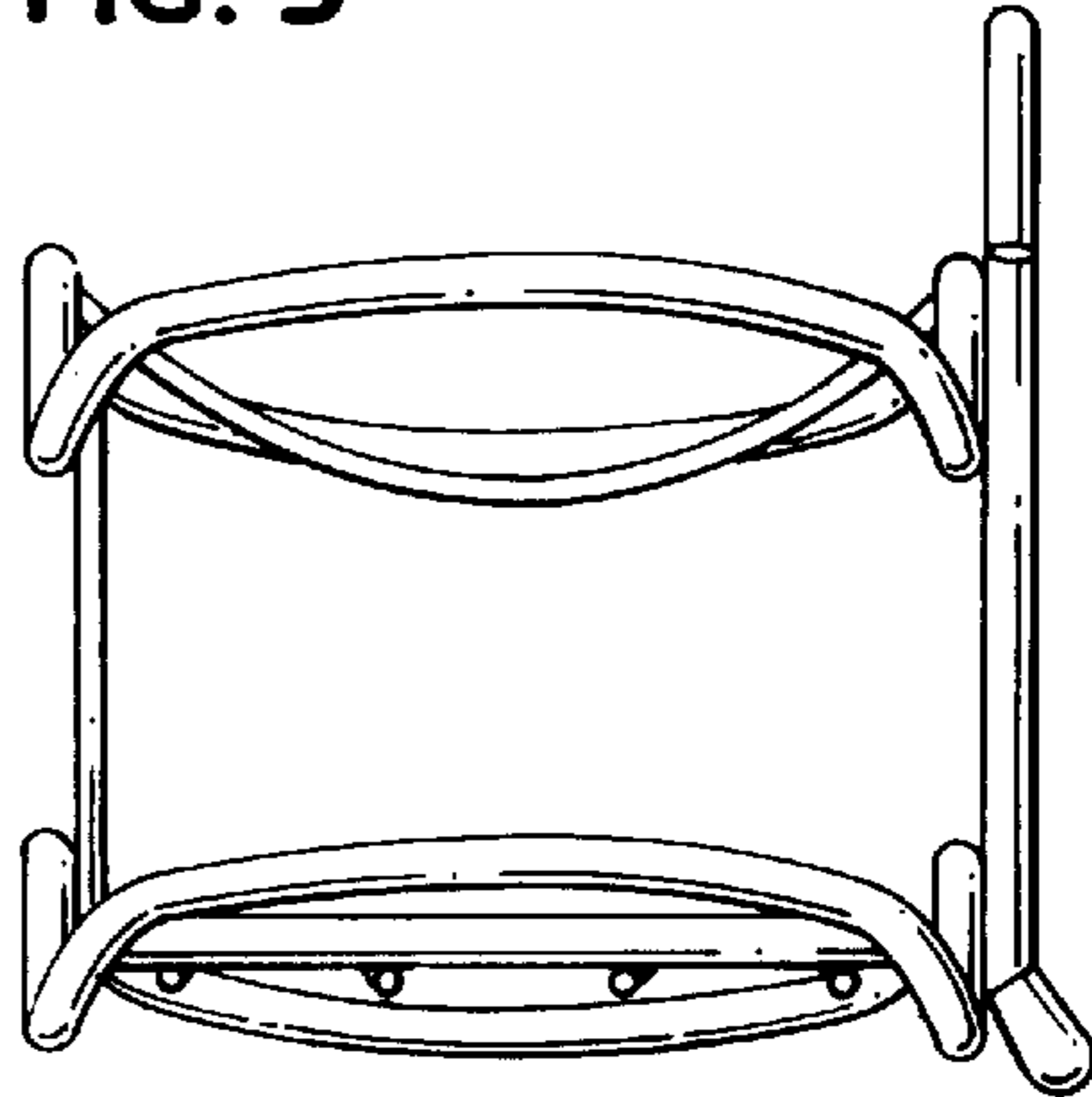

FIG. 6

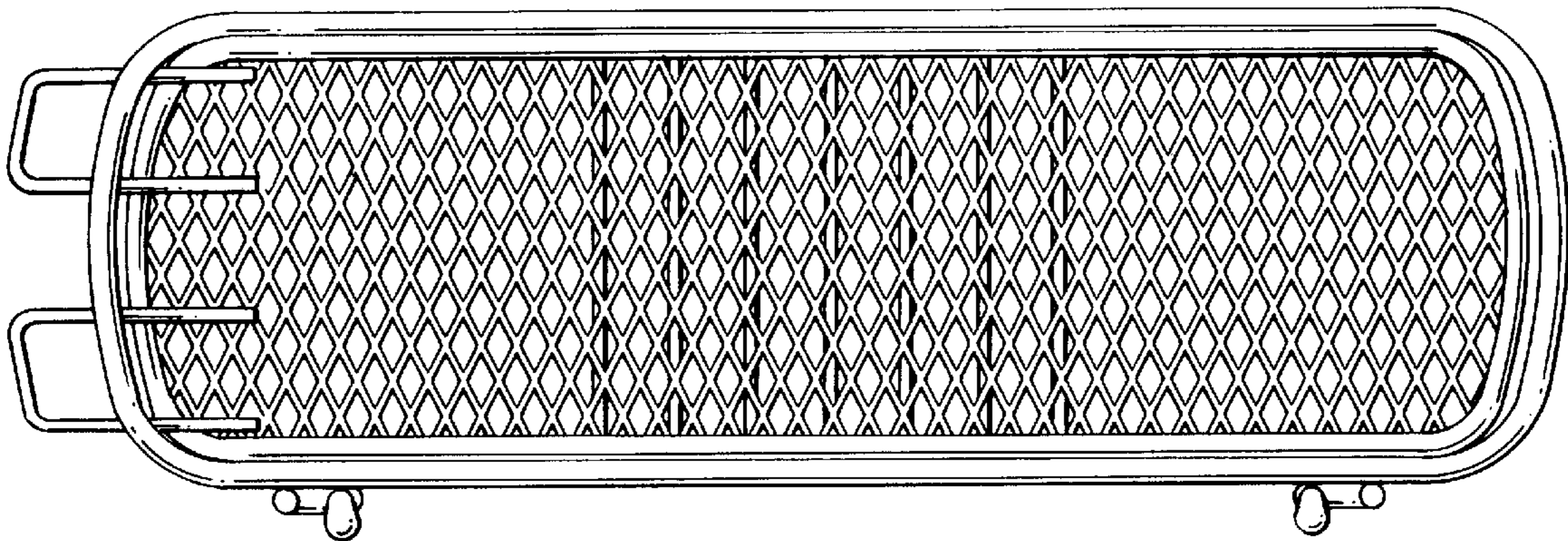

FIG. 7

