



US00D428740S

# United States Patent [19] Maly

[11] **Patent Number: Des. 428,740**

[45] **Date of Patent: \*\* Aug. 1, 2000**

[54] **WRITING TABLE**

5,598,790 2/1997 Fich ..... 108/153

[75] Inventor: **Peter Maly**, Hamburg, Germany

*Primary Examiner*—Janice E. Seeger  
*Attorney, Agent, or Firm*—Herbert Dubno

[73] Assignee: **Mauser Office GmbH**, Korbach, Germany

[57] **CLAIM**

[\*\*] Term: **14 Years**

The ornamental design for a writing table, as shown and described.

[21] Appl. No.: **29/100,029**

### DESCRIPTION

[22] Filed: **Feb. 2, 1999**

### [30] Foreign Application Priority Data

Aug. 4, 1998 [DE] Germany ..... 498 07 957

[51] **LOC (7) Cl.** ..... **06-03**

[52] **U.S. Cl.** ..... **D6/480**

[58] **Field of Search** ..... D6/480-489, 422-428, D6/495-499; 108/153.1, 155, 156, 161, 158.11, 50.01, 50.02; 312/194-196; 248/188, 188.1, 188.8

FIG. 1 is a top plan view of a writing table showing a first embodiment of my new design;

FIG. 2 is a bottom plan view thereof;

FIG. 3 is a left side elevational view thereof, the right side elevational view being identical thereto;

FIG. 4 is a front elevational view thereof, the rear view being identical thereto;

FIG. 5 is a top plan elevational view of a second embodiment;

FIG. 6 is a left side elevational view thereof, the right side being identical thereto;

FIG. 7 is a bottom plan view thereof; and,

FIG. 8 is a front elevational view thereof, the rear view being identical thereto.

### [56] References Cited

#### U.S. PATENT DOCUMENTS

D. 343,311 1/1994 Ball ..... D6/487

D. 403,898 1/1999 Arnegger ..... D6/480

**1 Claim, 3 Drawing Sheets**

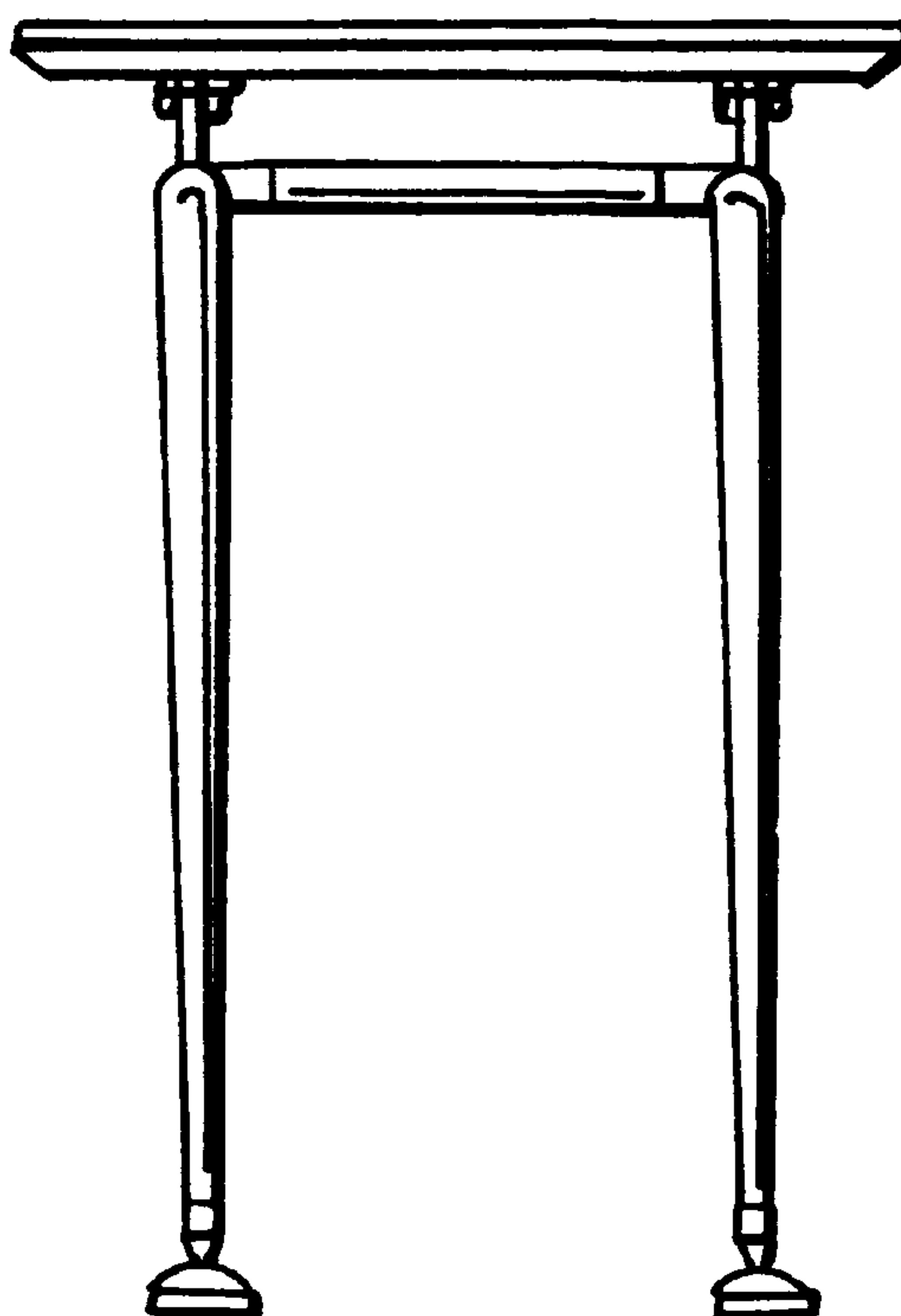
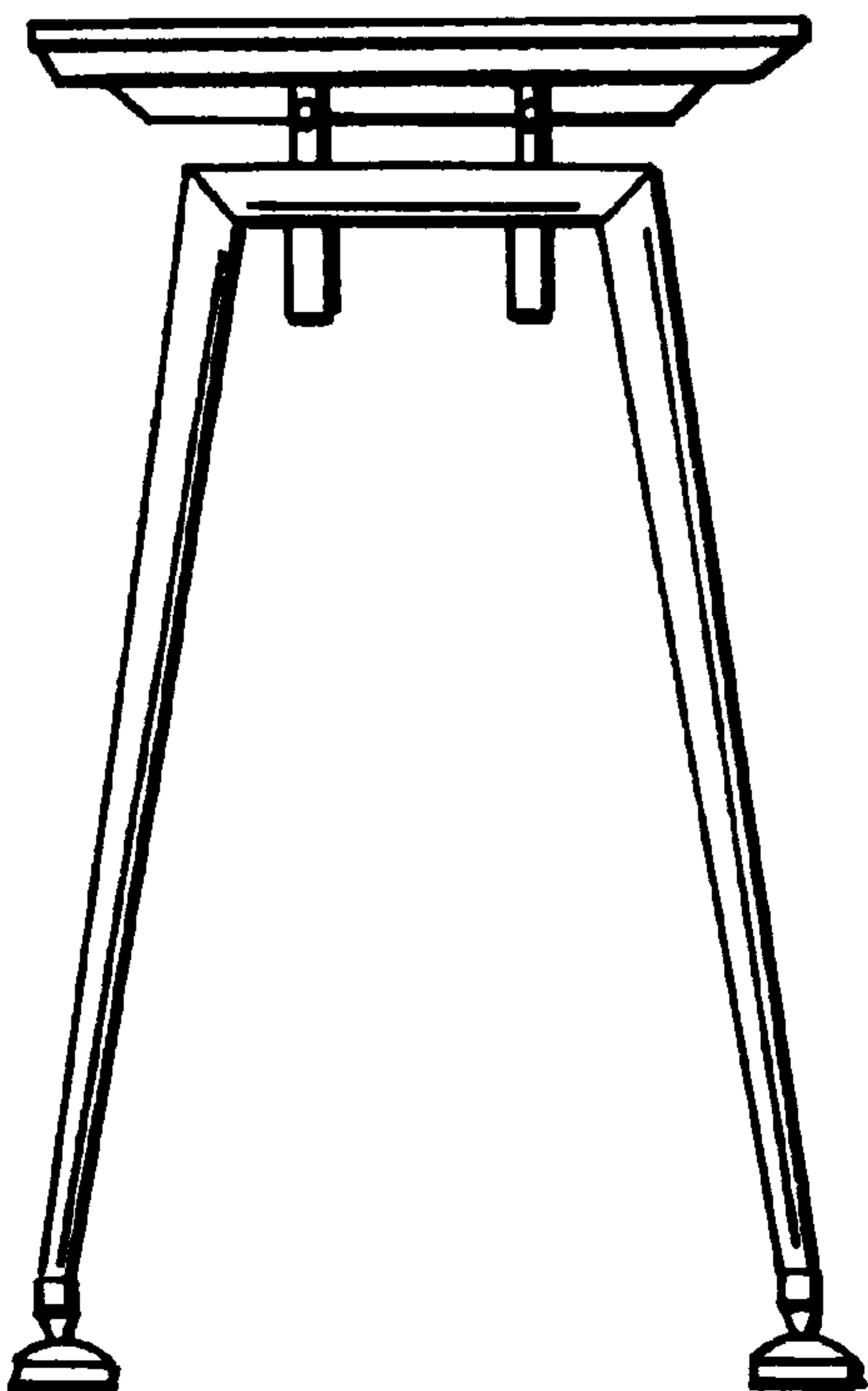

FIG. 1

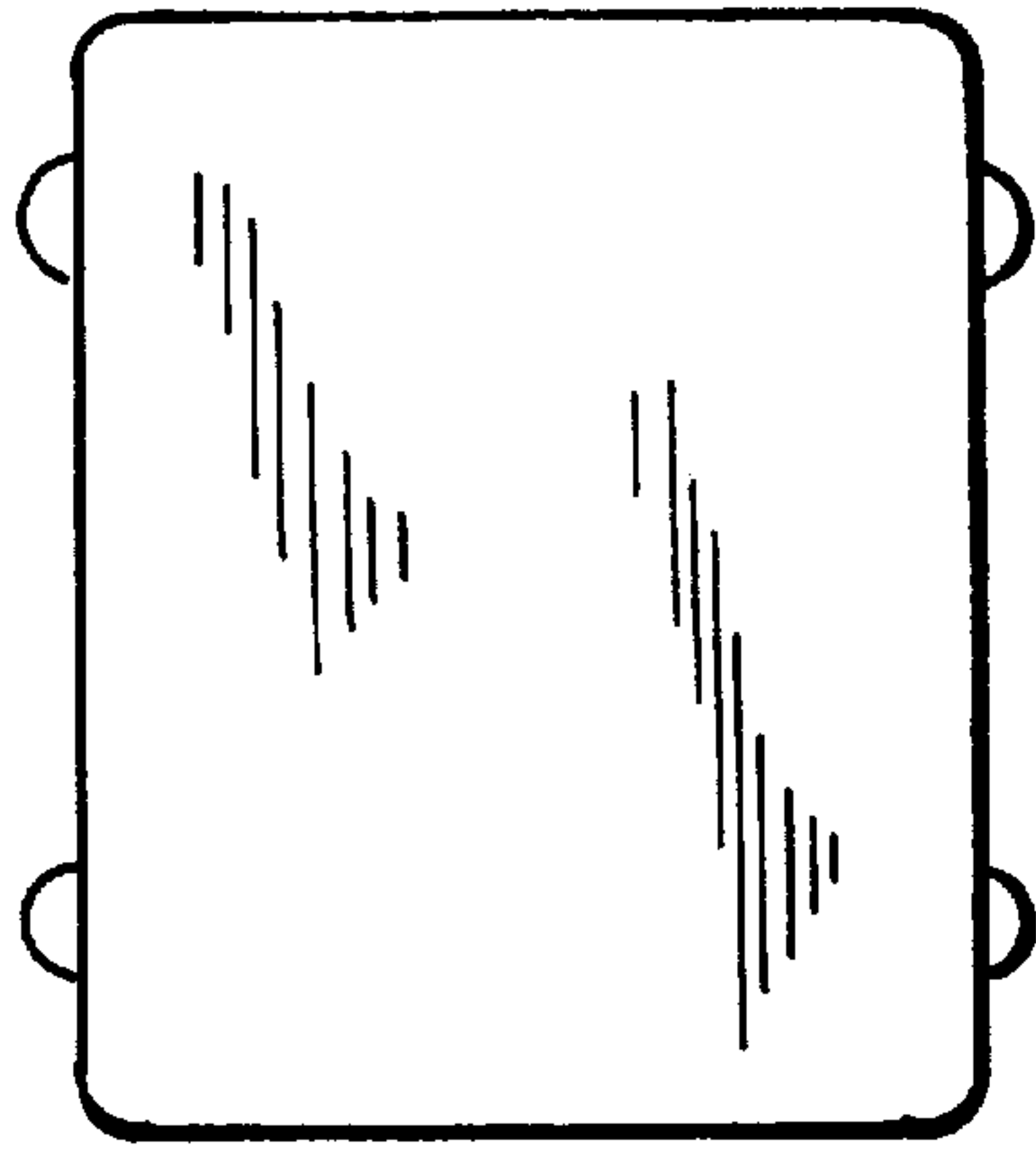

FIG. 2

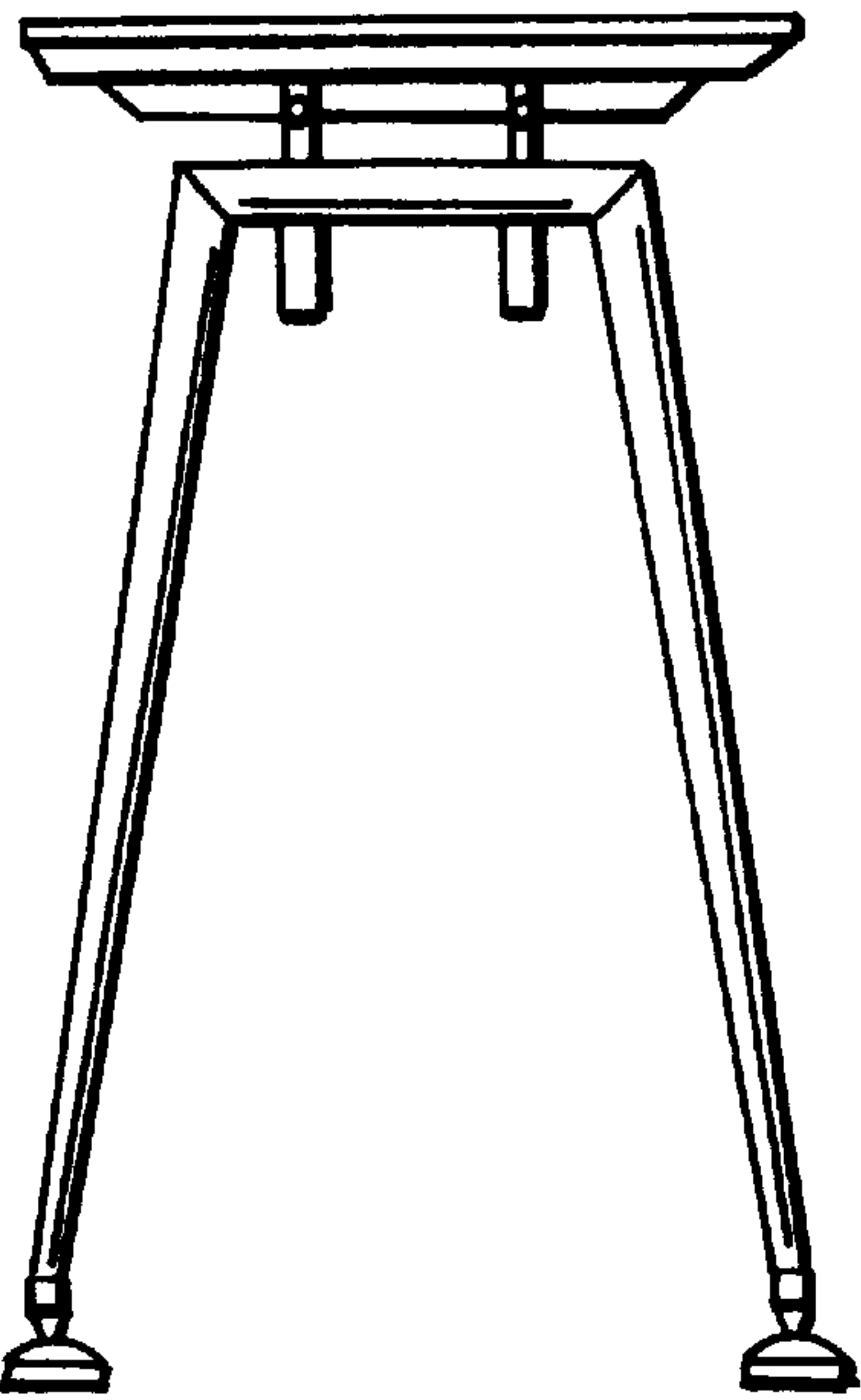
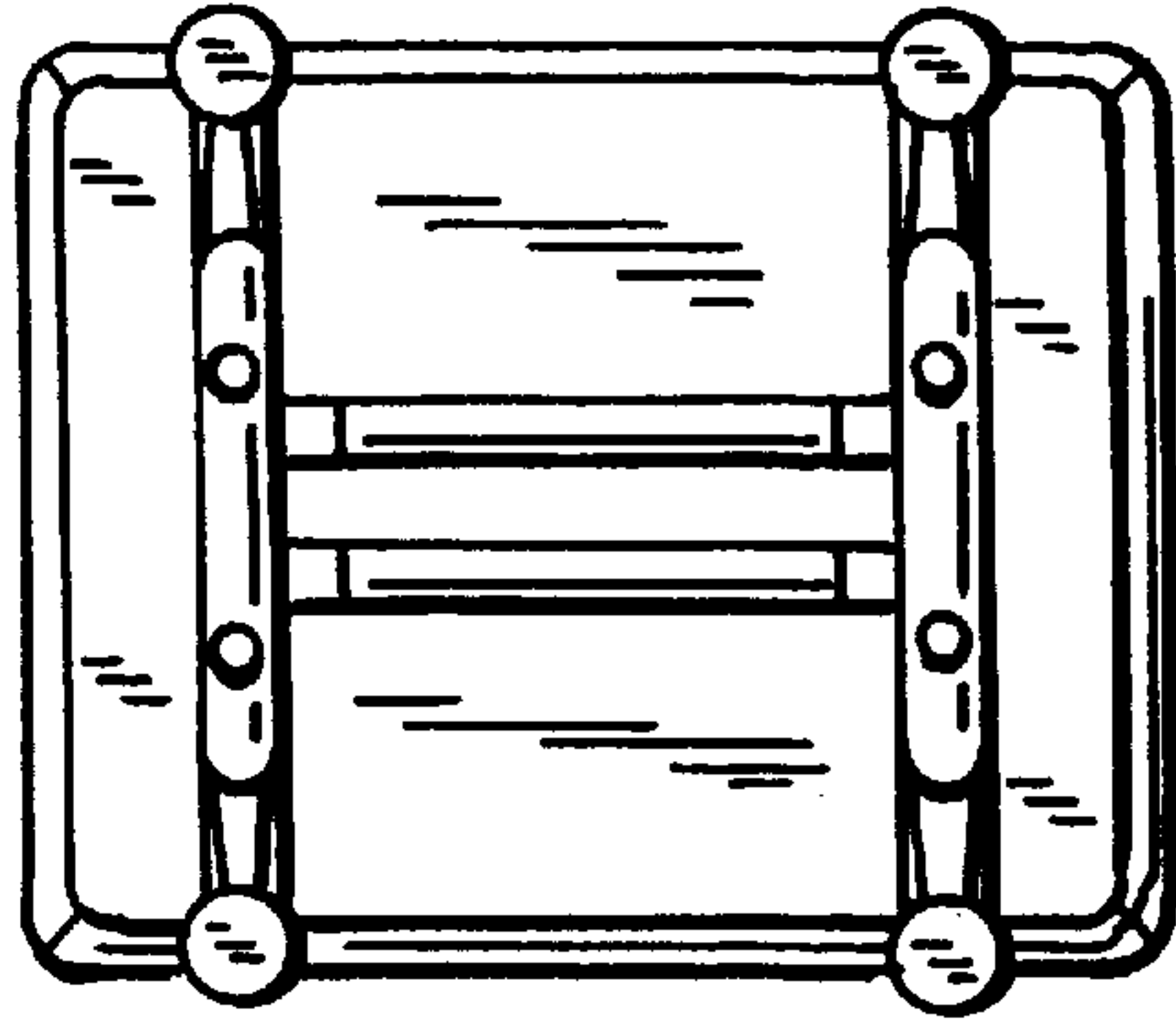

FIG. 3

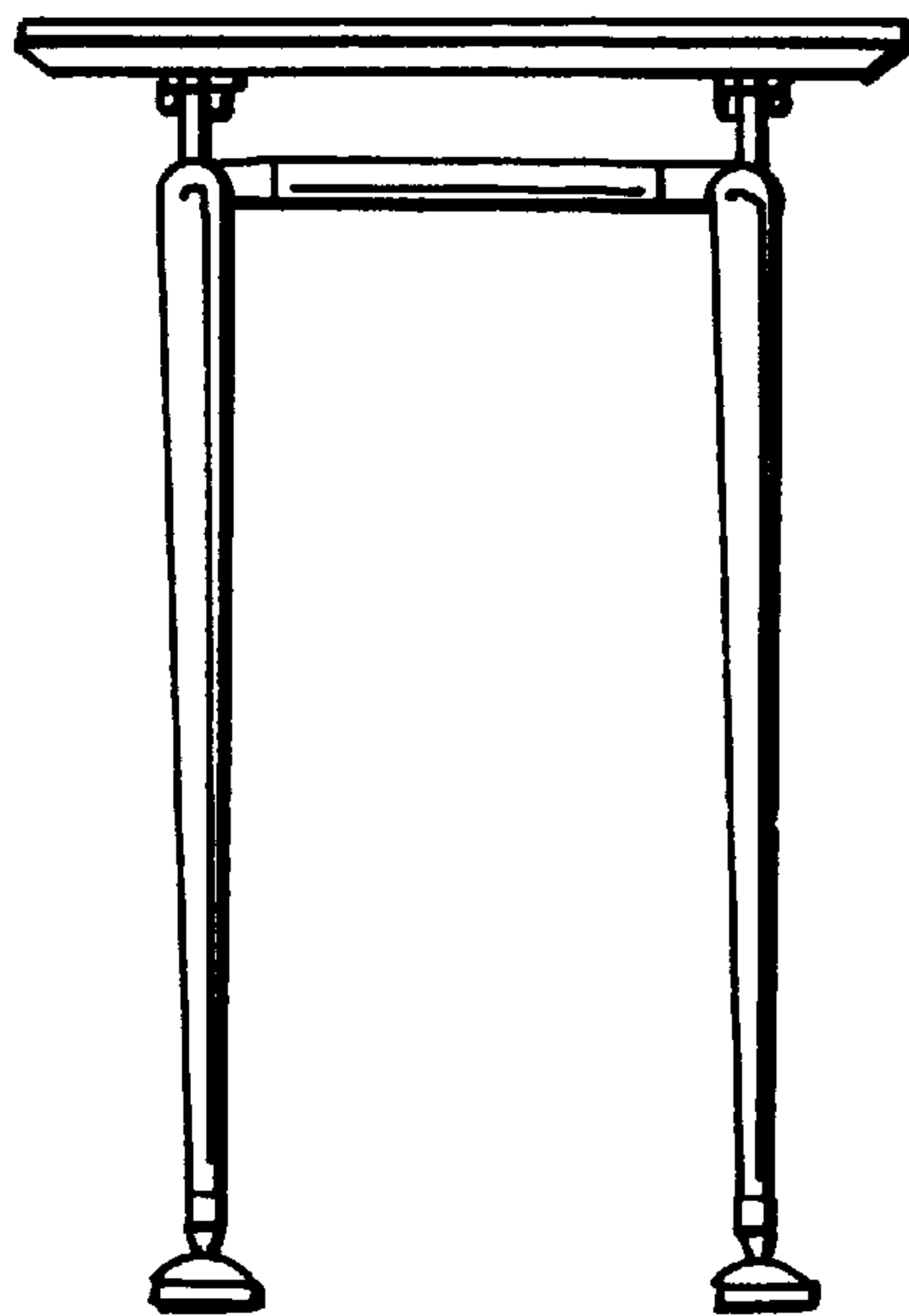

FIG. 4

FIG. 5

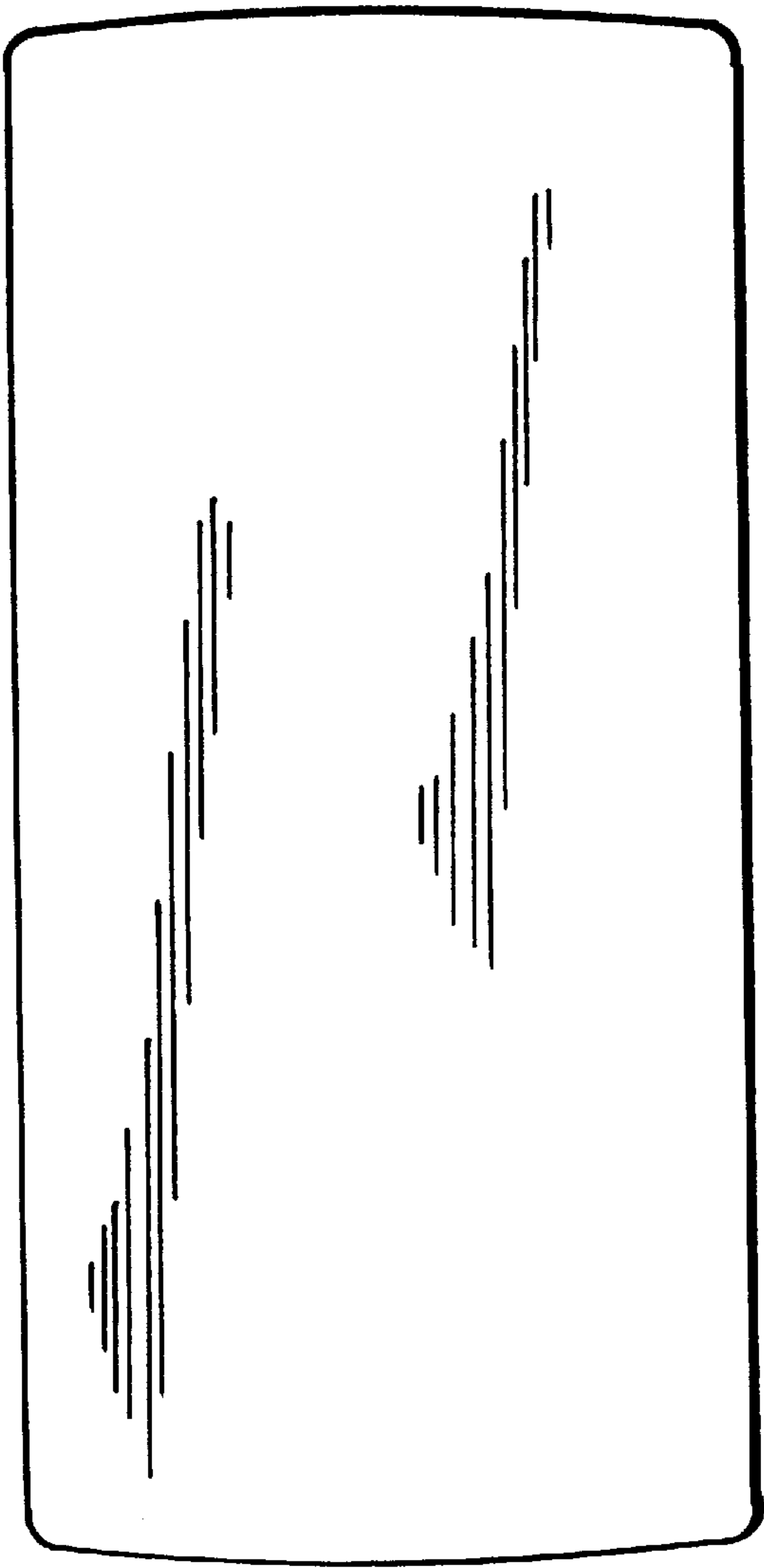

FIG. 6

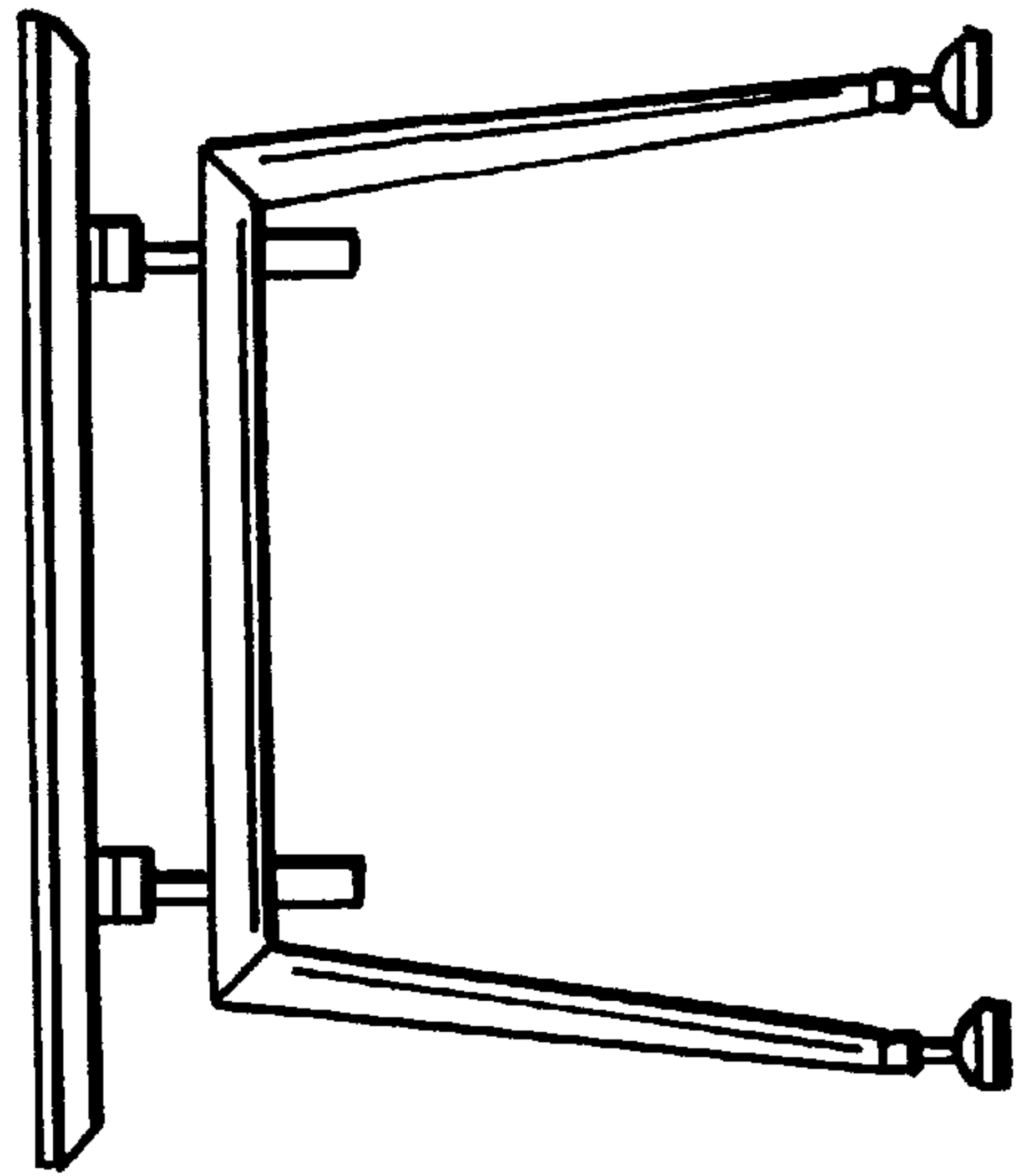

FIG. 7

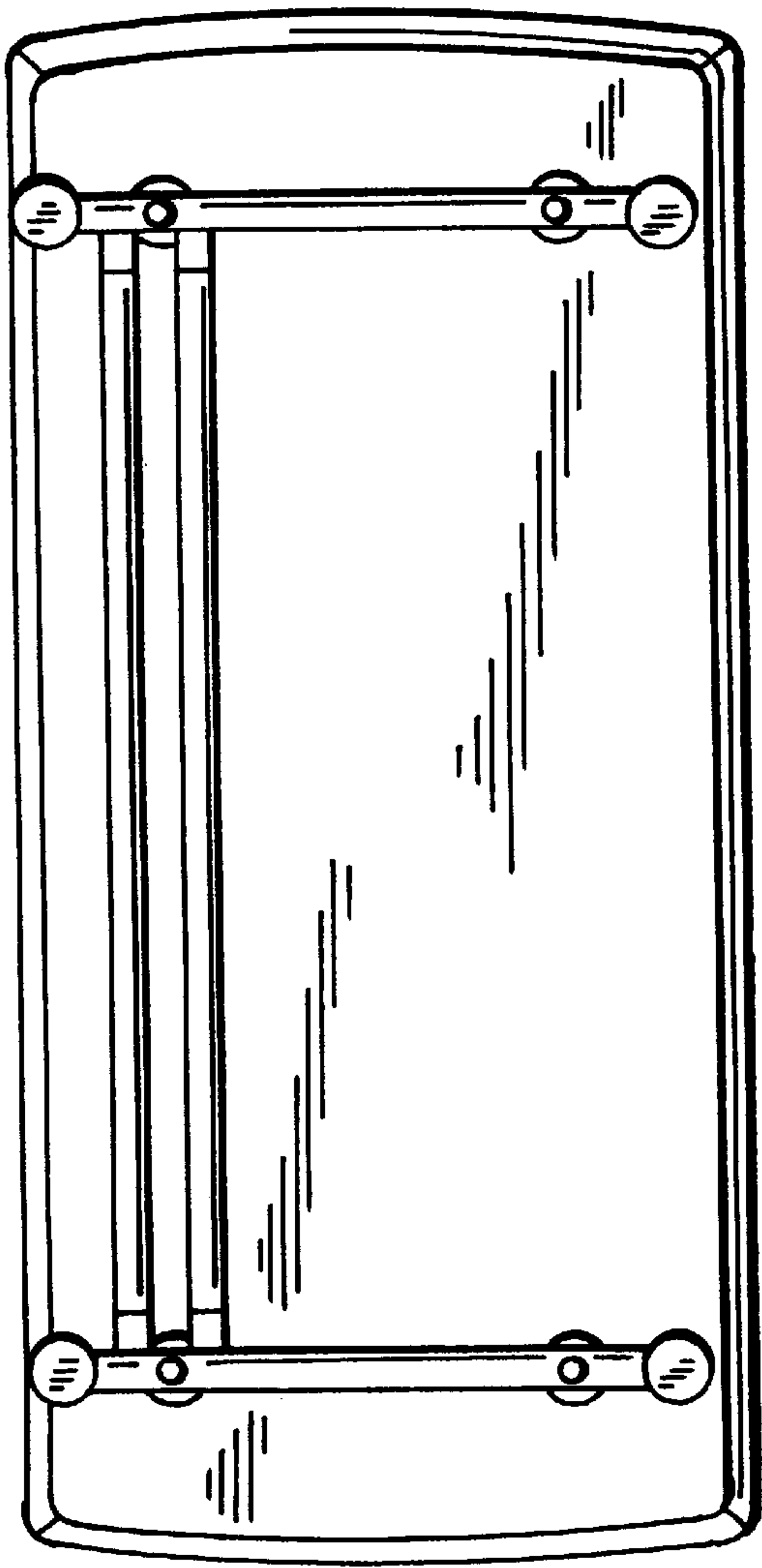

FIG. 8

