



US00D428728S

**United States Patent** [19]  
**Brown**

[11] **Patent Number: Des. 428,728**

[45] **Date of Patent: \*\* Aug. 1, 2000**

[54] **FLOWER POT CONTAINER**

[76] Inventor: **Lawrence A. Brown**, 798 E. Brown Rd., Pekin, Ind. 47165

[\*\*] Term: **14 Years**

[21] Appl. No.: **29/108,547**

[22] Filed: **Jul. 30, 1999**

[51] **LOC (7) Cl.** ..... **11-99**

[52] **U.S. Cl.** ..... **D6/403; D6/450; D11/149**

[58] **Field of Search** ..... D6/403, 382, 383, D6/393, 596, 597, 603, 450, 451; D21/520; D7/625, 628; 248/27.8; D11/143, 149, 155, 157; 47/44-47, 65.5, 72, 39, 40; 206/423, 457

[56] **References Cited**

**U.S. PATENT DOCUMENTS**

D. 87,579	8/1932	Hoey	.....	D6/393 X
D. 181,561	11/1957	Voll	.....	D6/404
D. 316,687	5/1991	Wilby	.....	D11/149
D. 393,378	4/1998	Hutton	.....	D6/393

*Primary Examiner*—Doris V. Coles  
*Assistant Examiner*—Linda Brooks  
*Attorney, Agent, or Firm*—Carrithers Law Office; David W. Carrithers

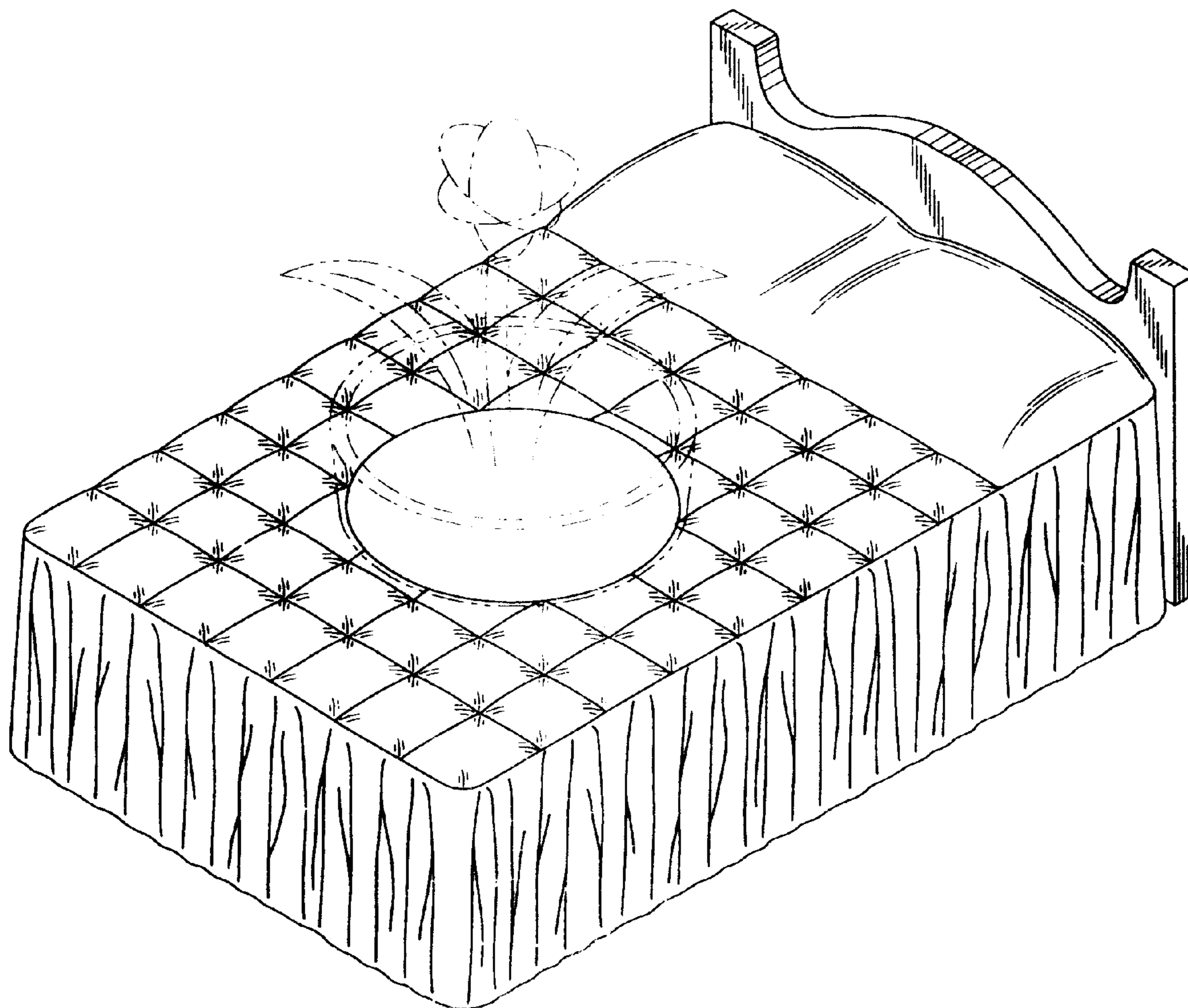
[57] **CLAIM**

The ornamental design for a flower pot container, as shown and described.

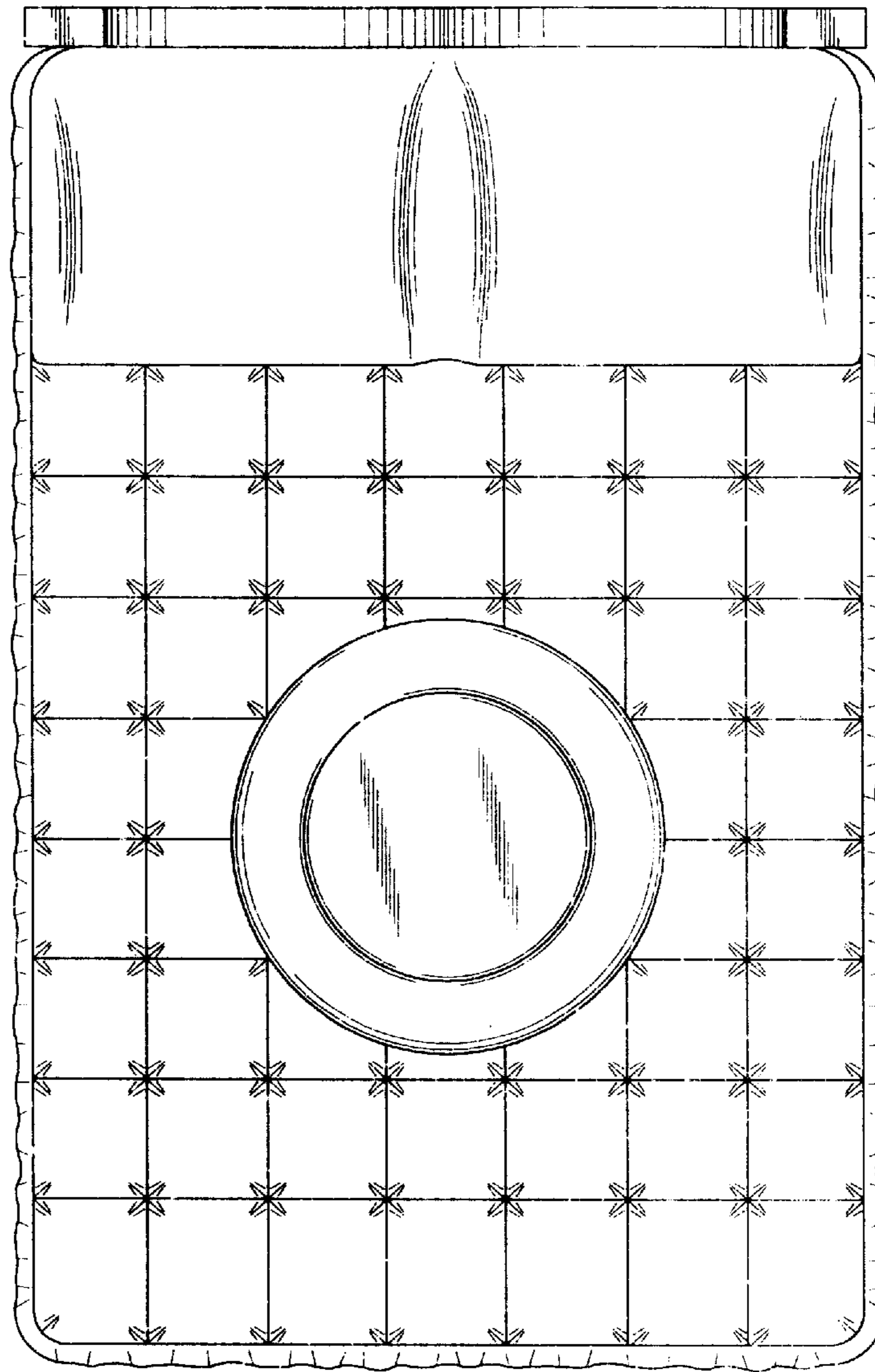
**DESCRIPTION**

FIG. 1 is a plan top view of a flower pot container in accordance with my design;  
FIG. 2 is front view thereof;  
FIG. 3 is a right side view thereof;  
FIG. 4 is a left side view thereof;  
FIG. 5 is a rear end view thereof;  
FIG. 6 is a bottom view thereof;  
FIG. 7 is a perspective view thereof on a reduced scale; and, FIG. 8 is another perspective view similar to FIG. 7.  
The broken line showing of a flower pot and flower is for illustrative purposes only and forms no part of the claimed design.

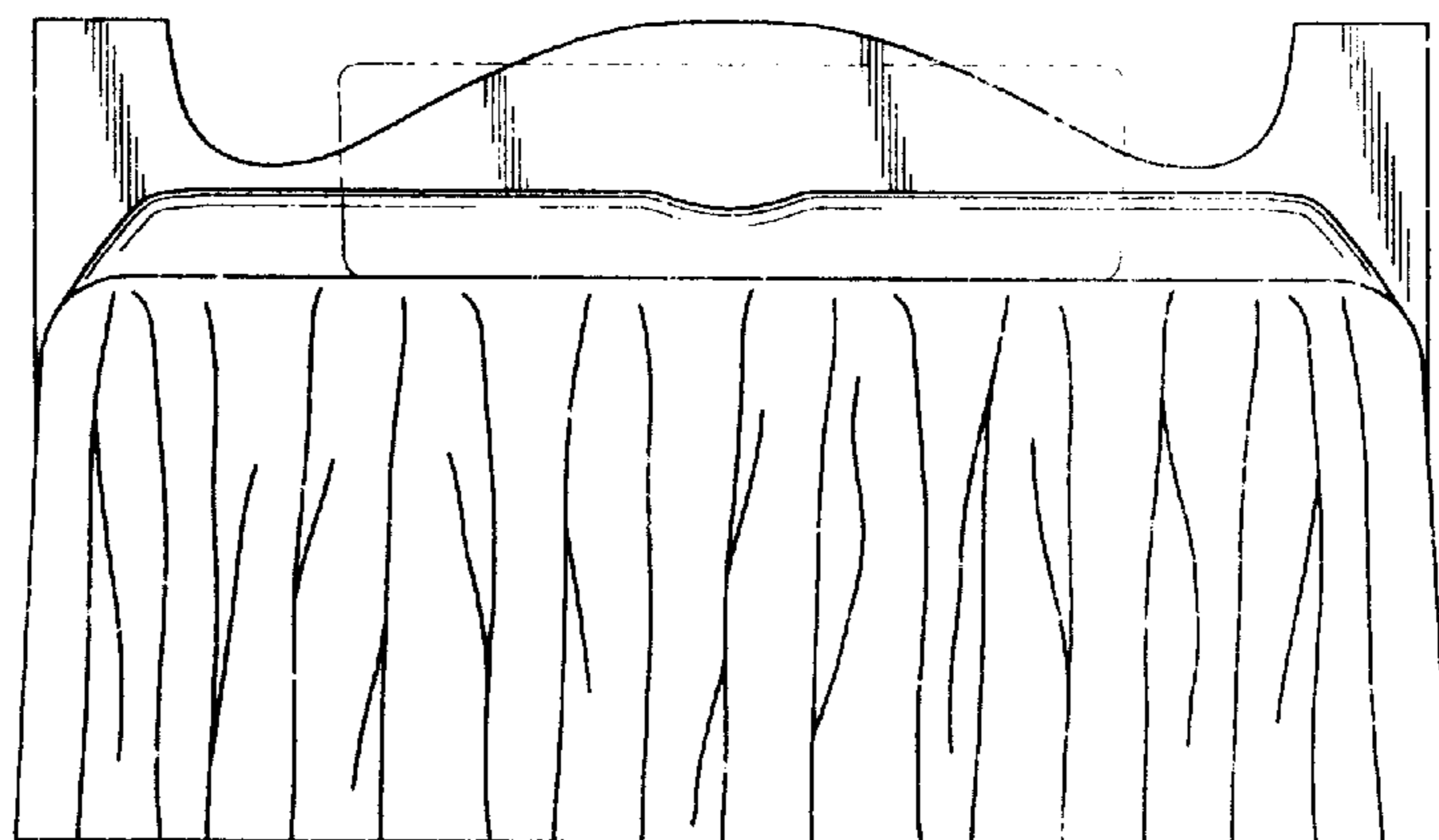
**1 Claim, 4 Drawing Sheets**



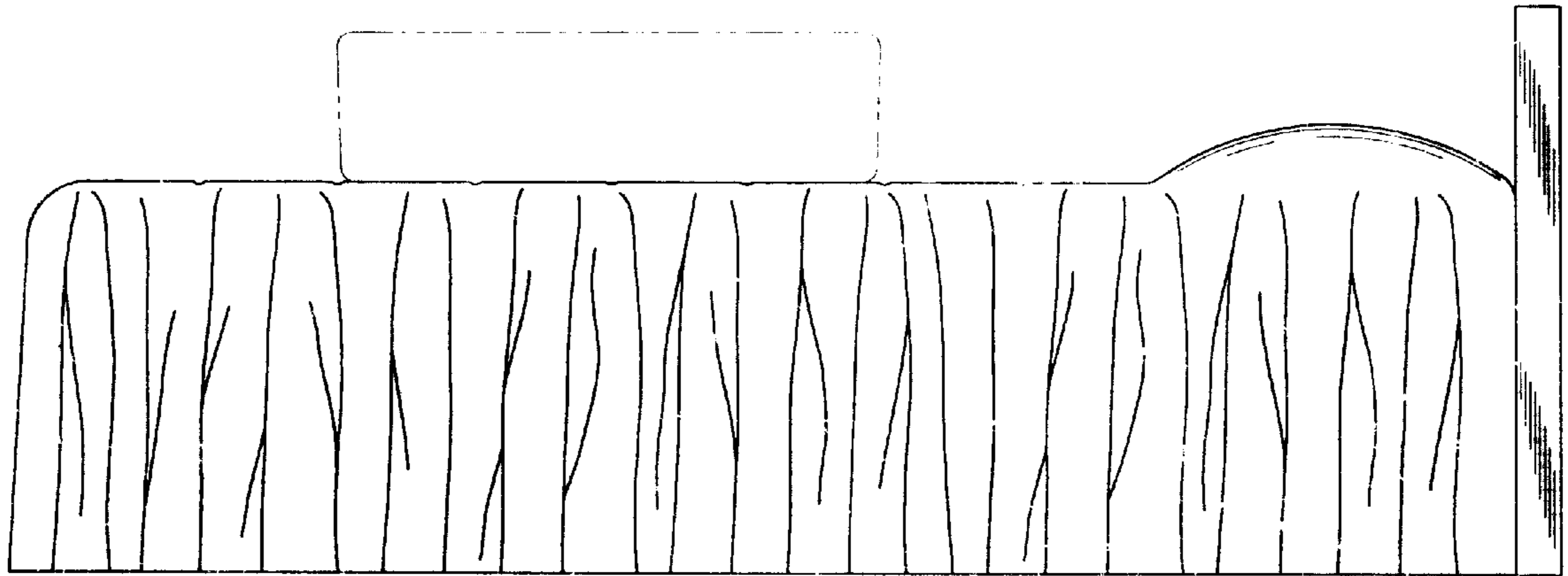
*FIG. 1*



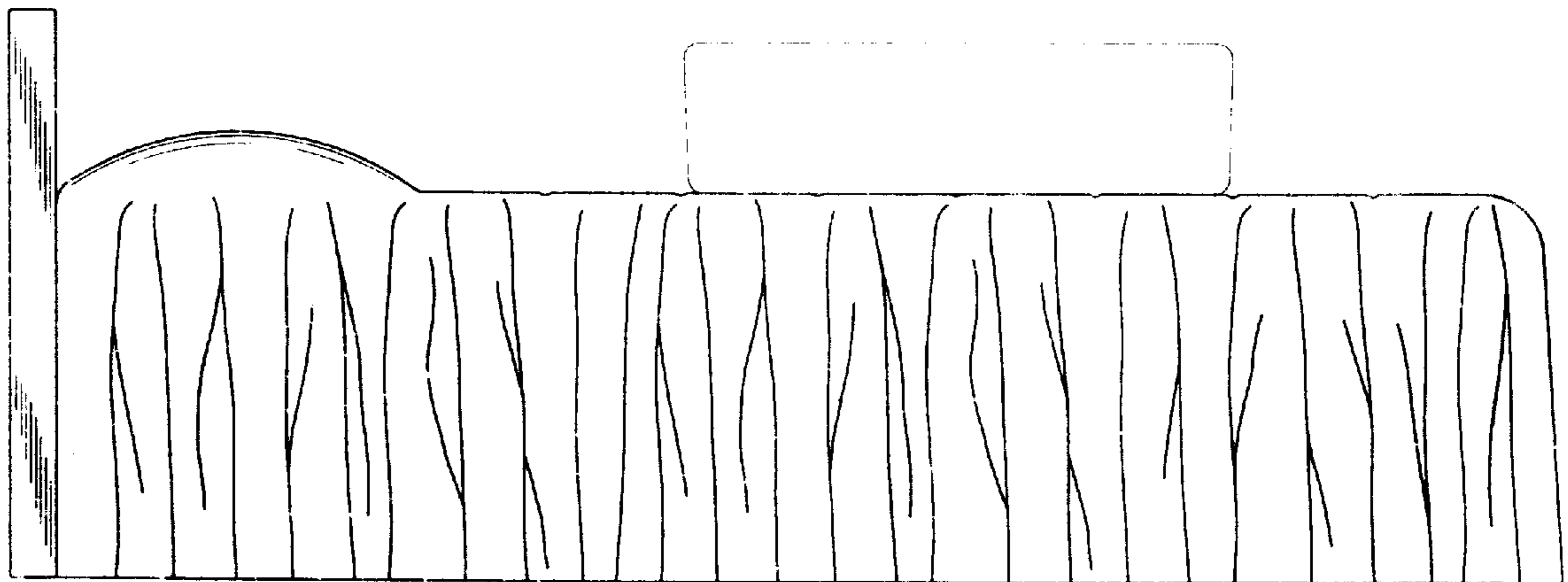
*FIG. 2*



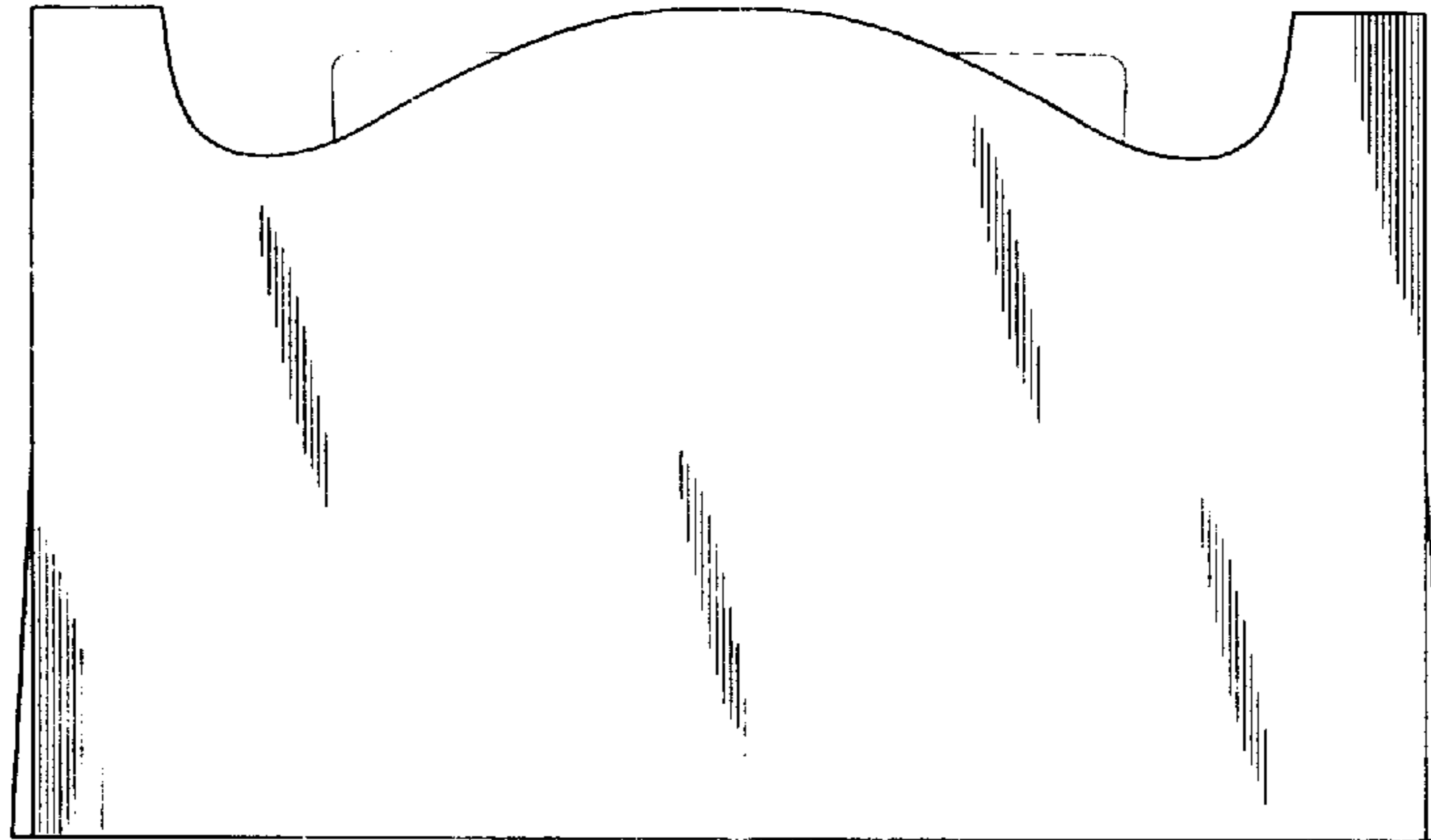
*FIG. 3*



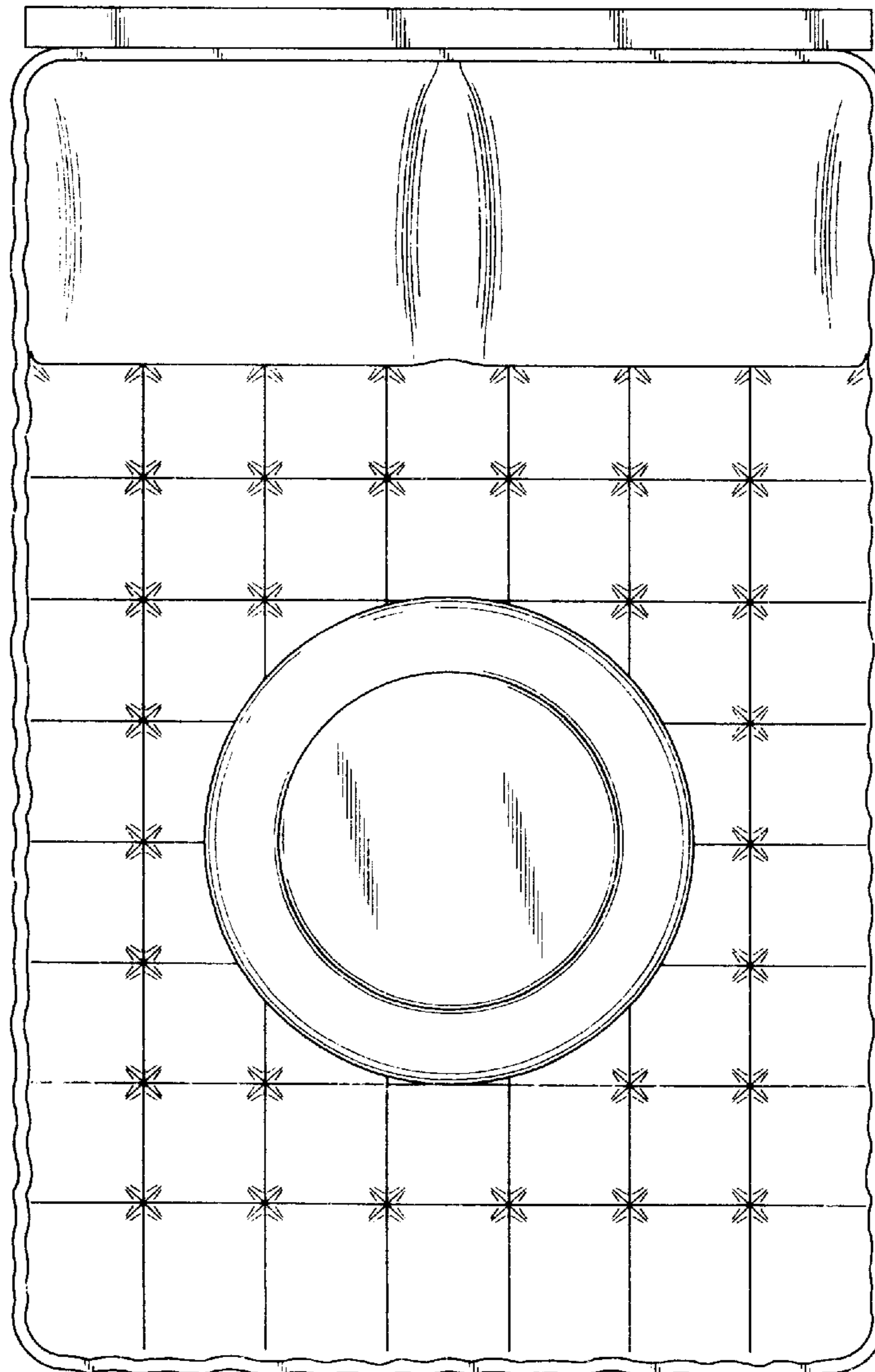
*FIG. 4*



*FIG. 5*

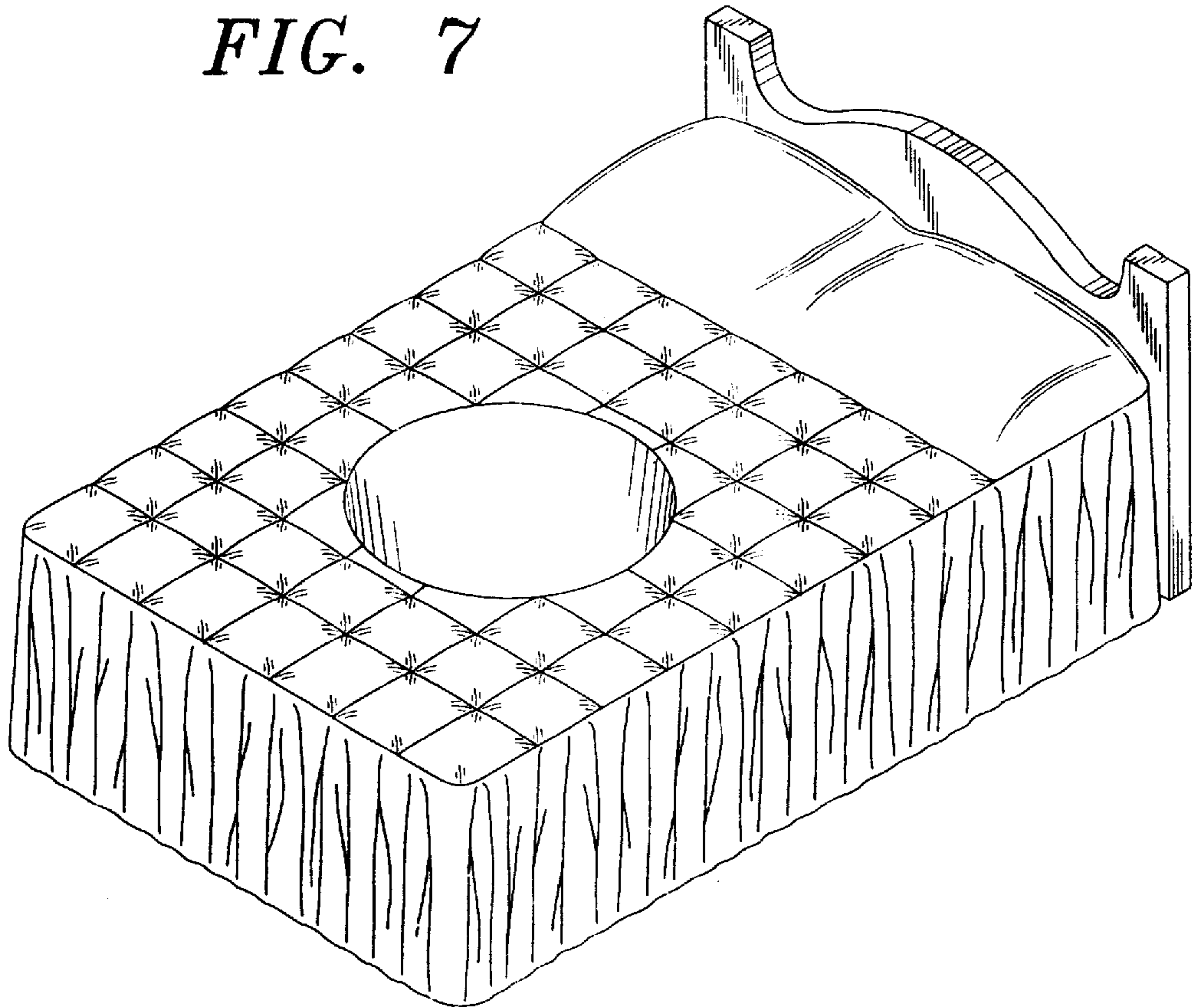


*FIG. 6*





*FIG. 7*



*FIG. 8*

