



US00D428726S

**United States Patent** [19]  
**Graziano**

[11] **Patent Number: Des. 428,726**

[45] **Date of Patent: \*\* Aug. 1, 2000**

[54] **DECORATIVE BED FRAME**

[75] Inventor: **Julia Graziano**, Montclair, N.J.

[73] Assignee: **Julia Designs, Inc.**, Montclair, N.J.

[\*\*] Term: **14 Years**

[21] Appl. No.: **29/117,677**

[22] Filed: **Jan. 27, 2000**

**Related U.S. Application Data**

[62] Division of application No. 29/097,261, Dec. 2, 1998.

[51] **LOC (7) Cl.** ..... **06-01**

[52] **U.S. Cl.** ..... **D6/382**

[58] **Field of Search** ..... D6/382-385, 389-395,  
D6/495, 497; 5/200.1, 310, 286, 280, 281,  
907; 248/188.8

[56] **References Cited**

**U.S. PATENT DOCUMENTS**

D. 417,973 12/1999 Lacroix et al. .... D6/393  
2,501,878 3/1950 Shapiro ..... 5/310  
4,192,028 3/1980 Knoke ..... 5/181

**OTHER PUBLICATIONS**

Frames, Chervan, vol. 4, p. 36, #6318 leg at lower left.

*Primary Examiner*—Janice E. Seeger

*Attorney, Agent, or Firm*—Kenyon & Kenyon

[57] **CLAIM**

The ornamental design for a decorative bed frame, as shown and described.

**DESCRIPTION**

FIG. 1 is a perspective view of a design for a decorative bed frame.

FIG. 2 is a front elevational view of the decorative bed frame.

FIG. 3 is a right side elevational view of the decorative bed frame.

FIG. 4 is a top plan view of the decorative bed frame.

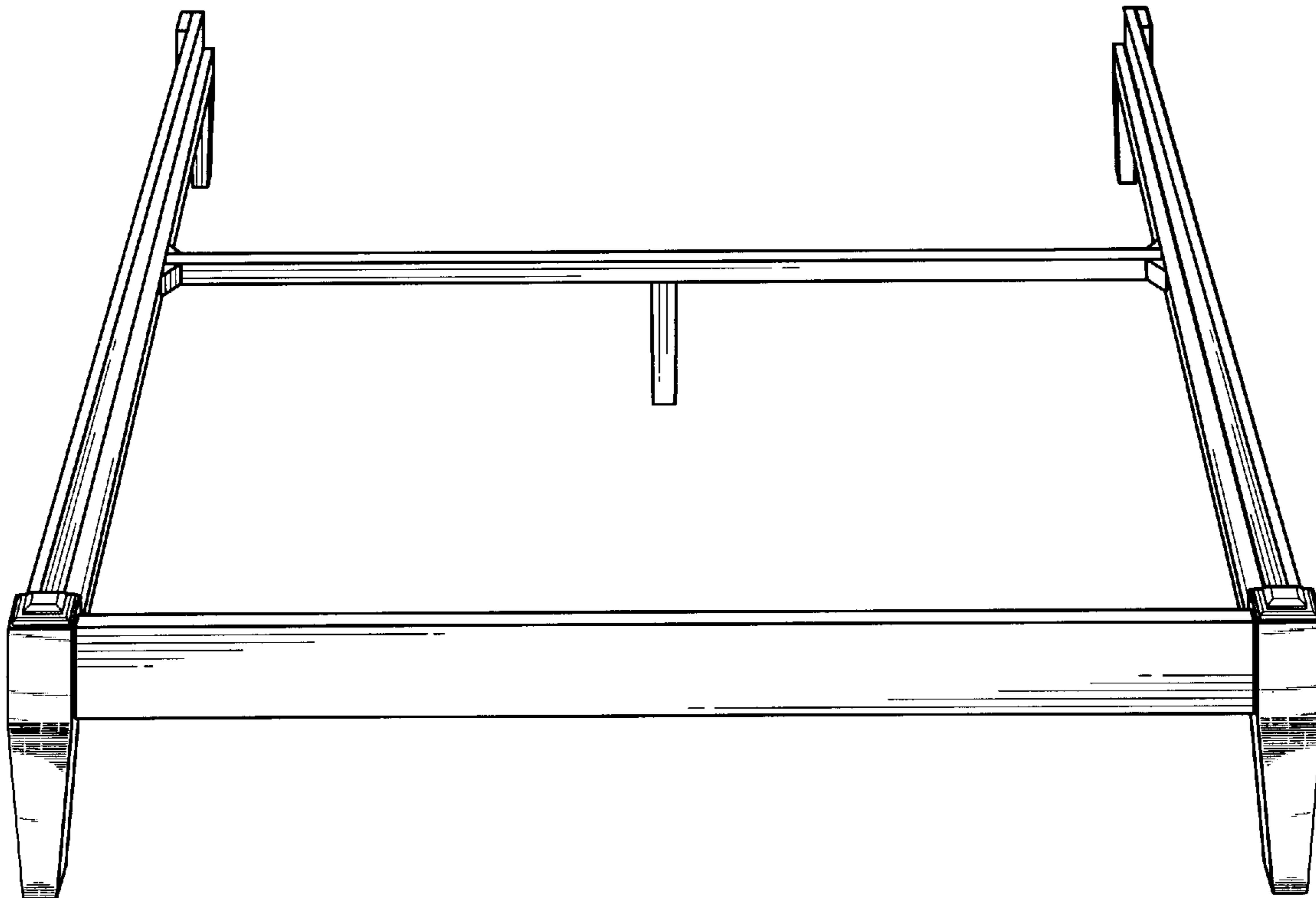
FIG. 5 is a rear elevational view of the decorative bed frame.

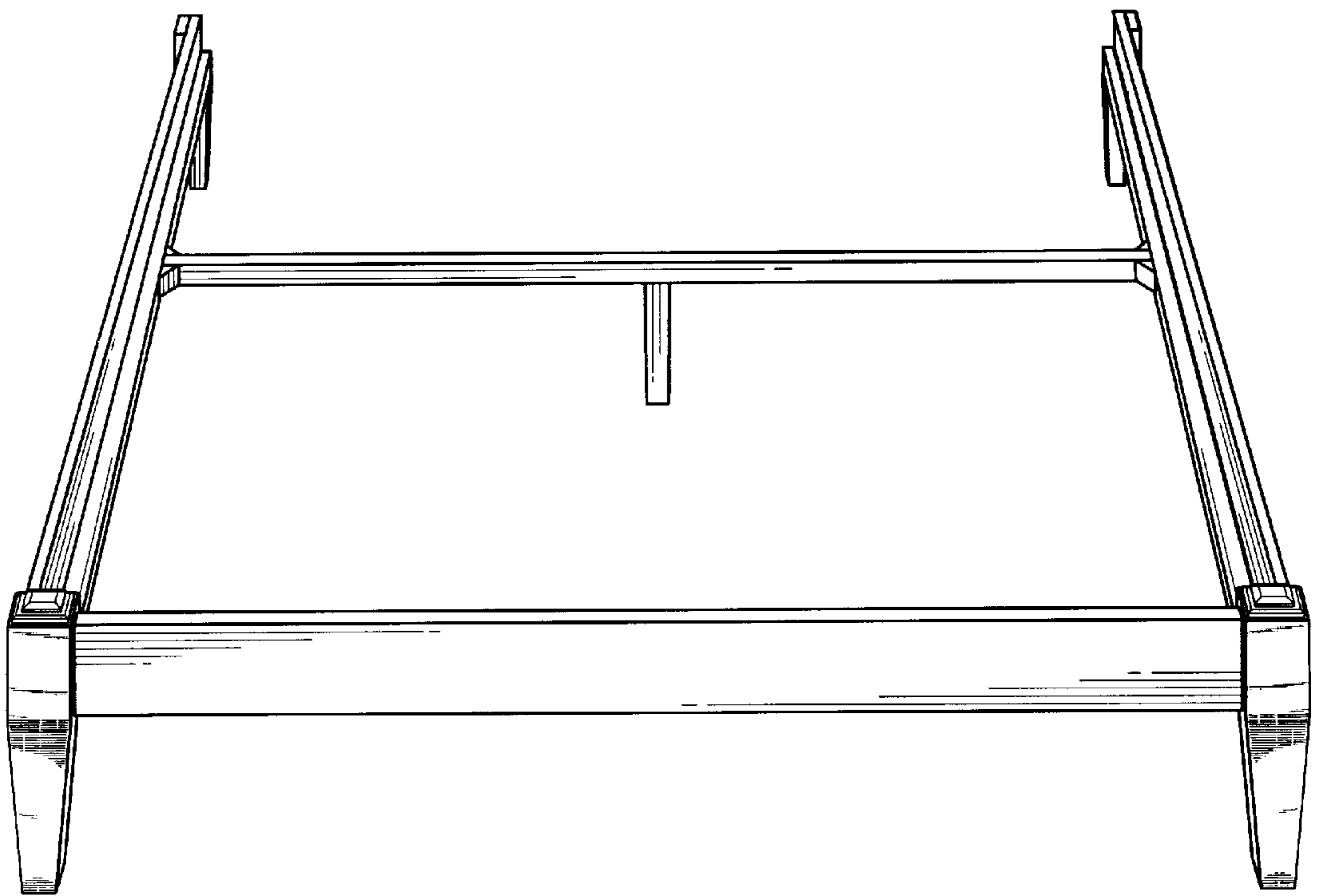
FIG. 6 is a top plan view showing in greater detail the left front leg of the decorative bed frame, the right front leg being a mirror image of the left front leg, wherein this view is only shown for convenience of illustration, and this view is not intended to show a distinct design separate from the decorative bed frame.

FIG. 7 is a right side elevational view showing in greater detail the left front leg of the decorative bed frame, wherein this view is only shown for convenience of illustration, and this view is not intended to show a distinct design separate from the decorative bed frame; and,

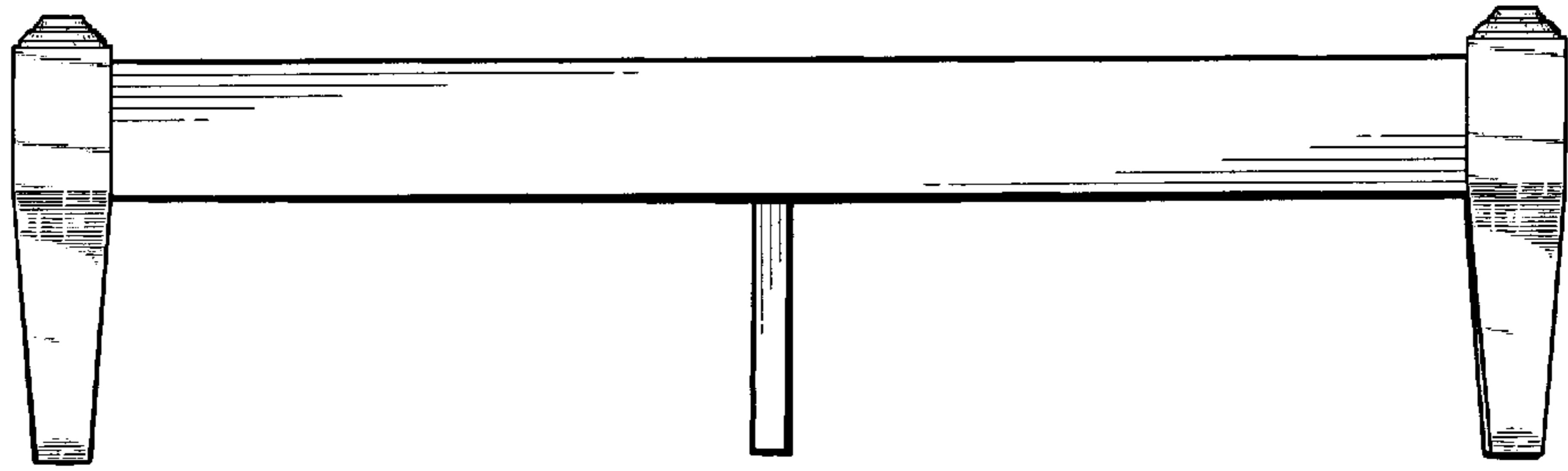
FIG. 8 is a perspective view showing in greater detail the left side, front and a portion of top of the left front leg of the decorative bed frame, wherein this view is only shown for convenience of illustration, and this view is not intended to show a distinct design separate from the decorative bed frame.

**1 Claim, 5 Drawing Sheets**

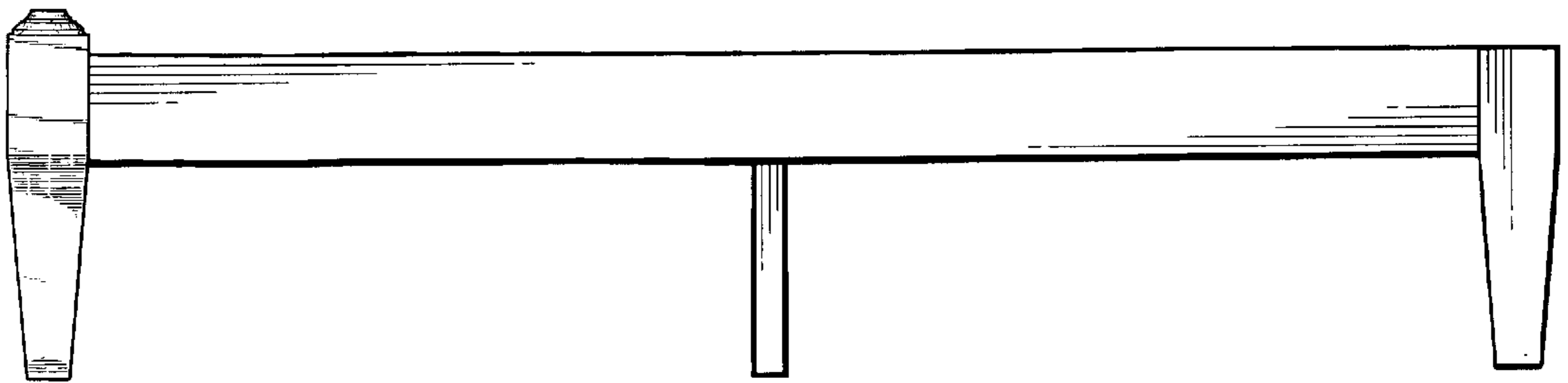




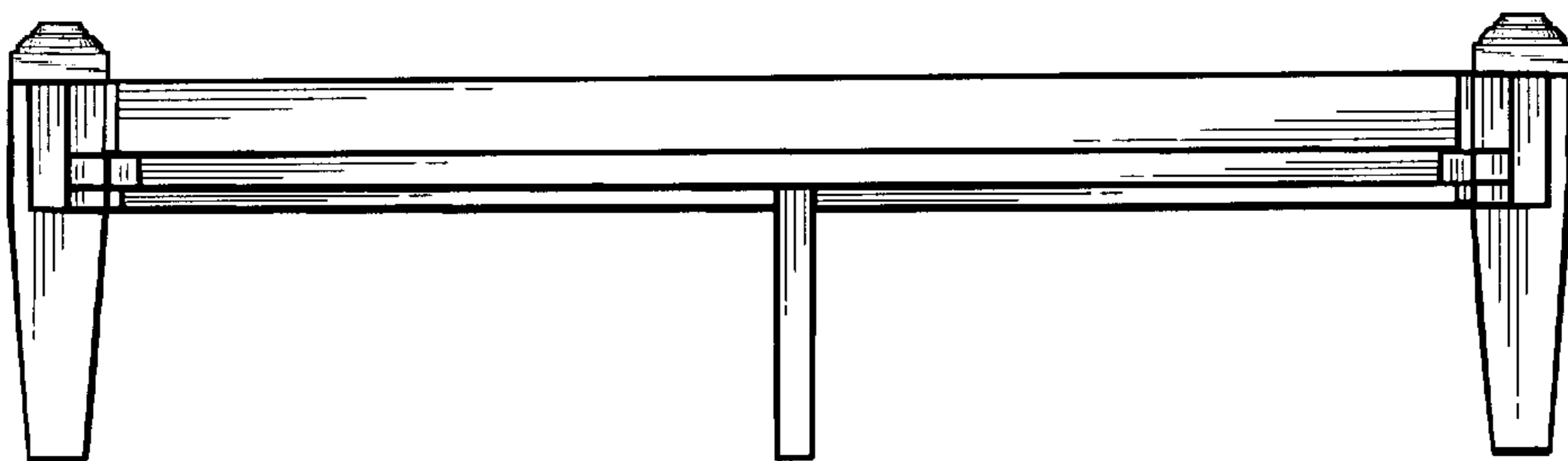
*FIG. 1*



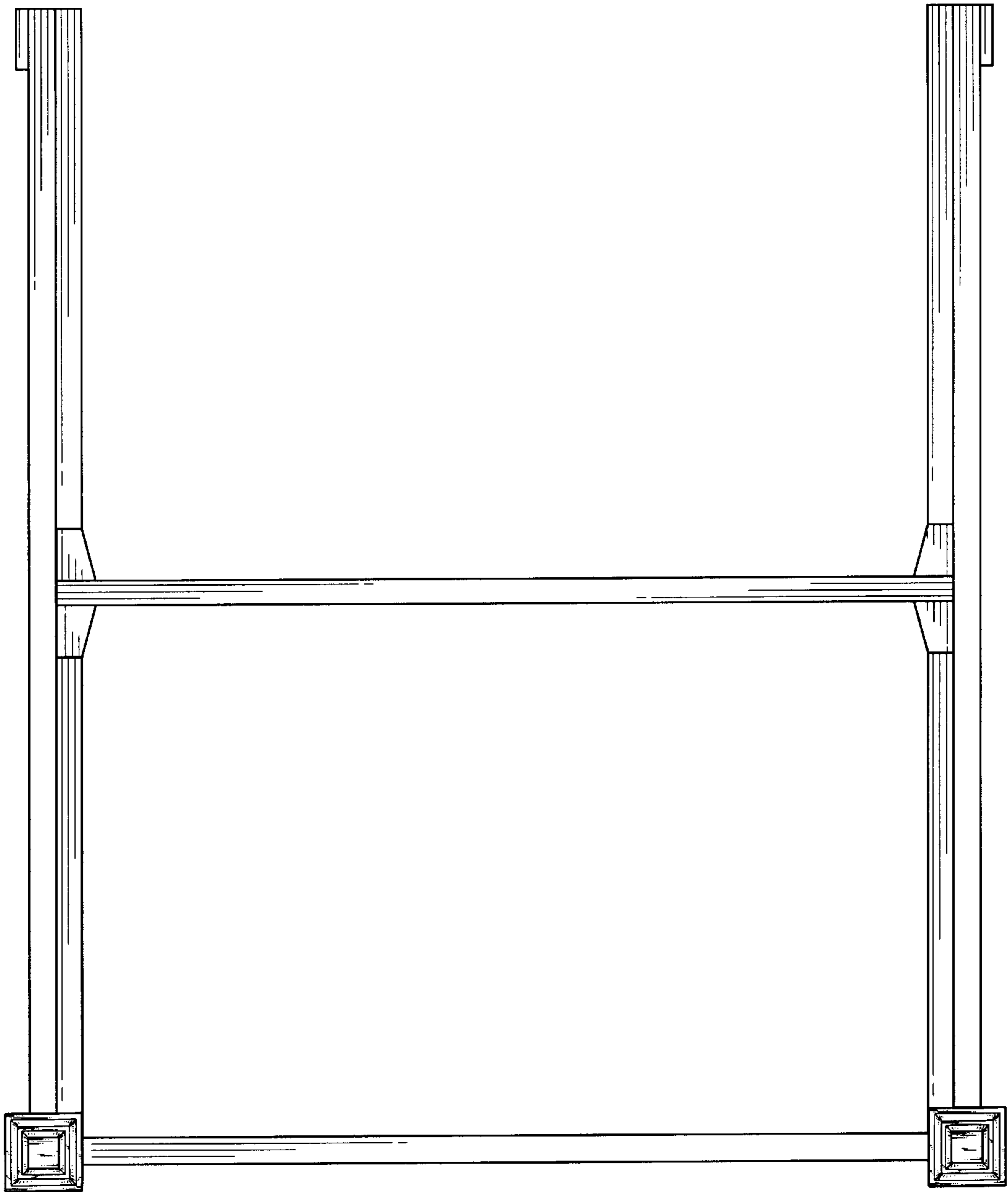
*Fig. 2*



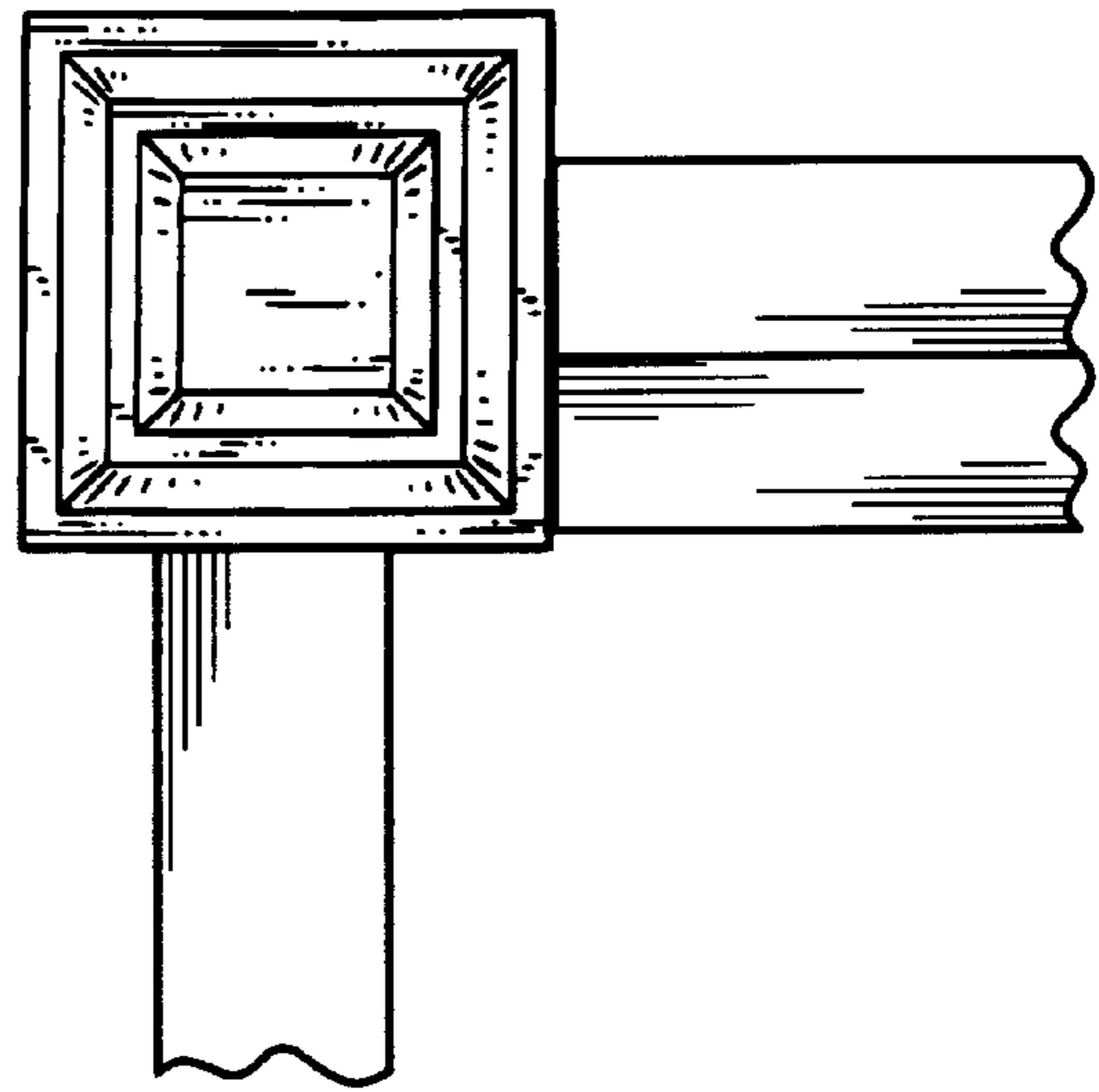
*Fig. 3*



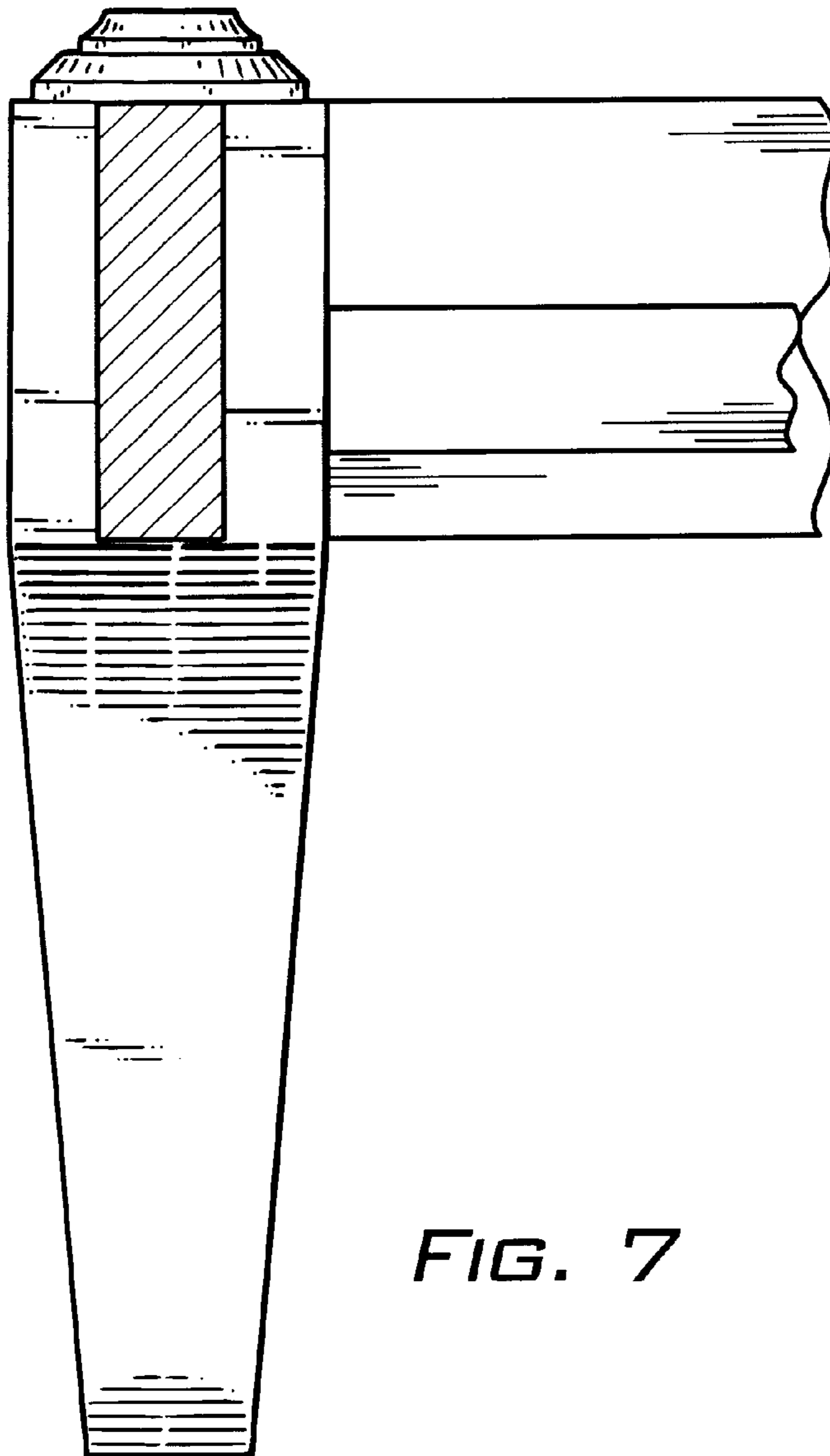
*Fig. 5*



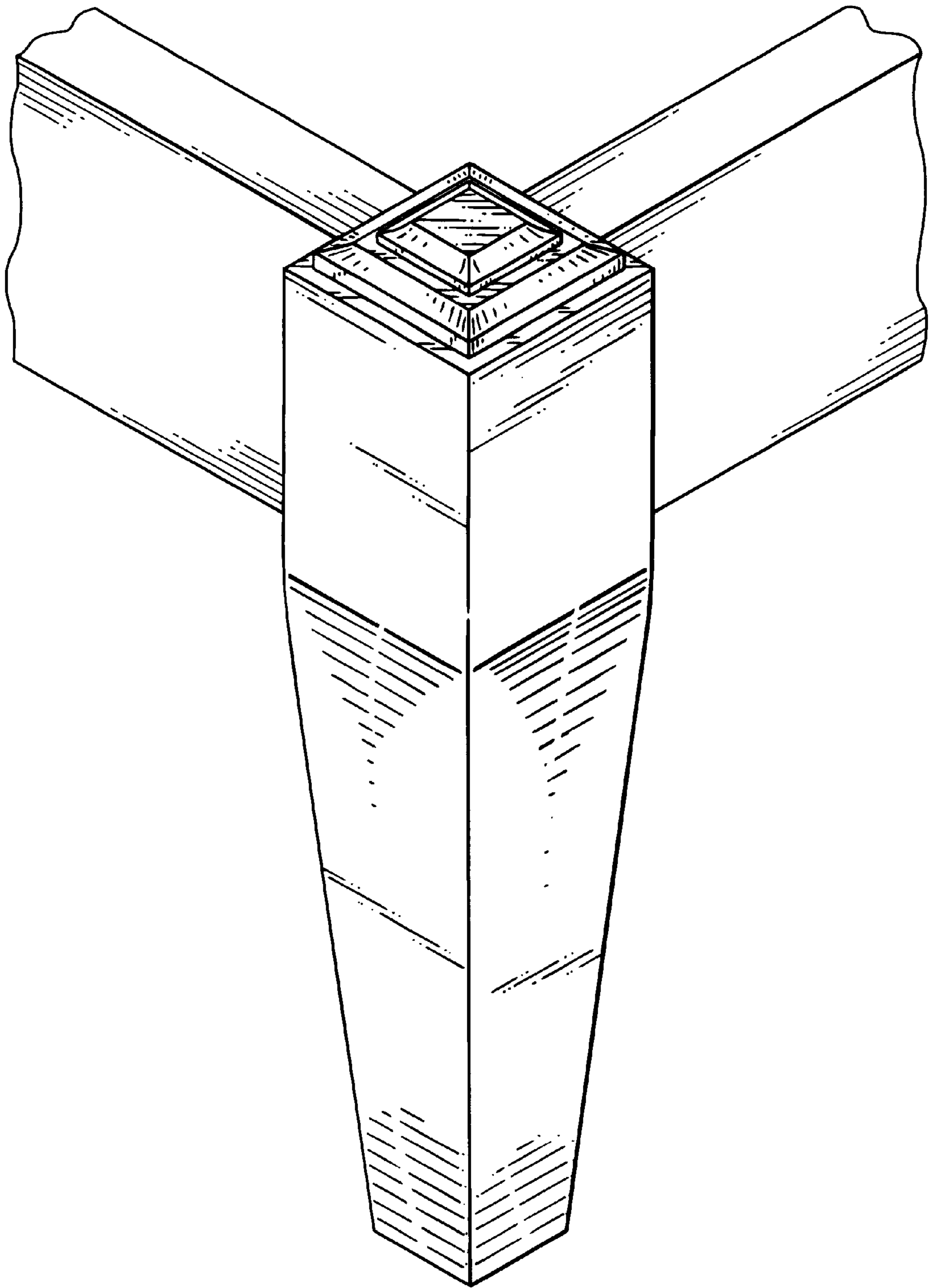
*Fig. 4*



*FIG. 6*



*FIG. 7*



*FIG. 8*