



US00D428701S

# United States Patent [19]

Lamo, Jr.

[11] Patent Number: **Des. 428,701**

[45] Date of Patent: **\*\* Aug. 1, 2000**

[54] **UNDERSEAT STORAGE BOX**

[75] Inventor: **Ralph J. Lamo, Jr.**, Annandale, N.J.

[73] Assignee: **Waylayers, Inc.**, Annandale, N.J.

[\*\*] Term: **14 Years**

[21] Appl. No.: **29/094,598**

[22] Filed: **Oct. 6, 1998**

[51] **LOC (7) Cl.** ..... **03-01**

[52] **U.S. Cl.** ..... **D3/313; D3/304**

[58] **Field of Search** ..... **D3/304, 313; D12/423, D12/424, 425; 206/561; 220/507; 224/275, 925**

[56] **References Cited**

**U.S. PATENT DOCUMENTS**

5,065,920	11/1991	Amner	.....	224/275
5,249,724	10/1993	Green	.....	224/275
5,339,955	8/1994	Horan et al.	.....	206/561 X
5,358,307	10/1994	Shafer et al.	.....	224/275 X
5,829,655	11/1998	Salopek	.....	224/275 X
5,957,521	9/1999	Schlachter	.....	224/275 X
5,967,602	10/1999	Ptak et al.	.....	224/275 X

*Primary Examiner*—Louis S. Zarfes  
*Assistant Examiner*—Monica A. Weingart  
*Attorney, Agent, or Firm*—Ezra Sutton

[57] **CLAIM**

The ornamental design for an underseat storage box, as shown and described.

**DESCRIPTION**

FIG. 1 is a perspective view of an underseat storage box embodying my new design;  
FIG. 2 is a front view thereof;  
FIG. 3 is a rear view thereof;  
FIG. 4 is a side view thereof, the other side view being mirror image thereof;  
FIG. 5 is a top plan view thereof;  
FIG. 6 is a bottom plan view thereof;  
FIG. 7 is a perspective view of an alternate underseat storage box embodying my new design;  
FIG. 8 is a top plan view thereof;  
FIG. 9 is a bottom plan view thereof; and,  
FIG. 10 is a rear view thereof.

The broken line showing of a seat and console in FIG. 1 is for illustrative purposes only and forms no part of the claimed design.

**1 Claim, 6 Drawing Sheets**

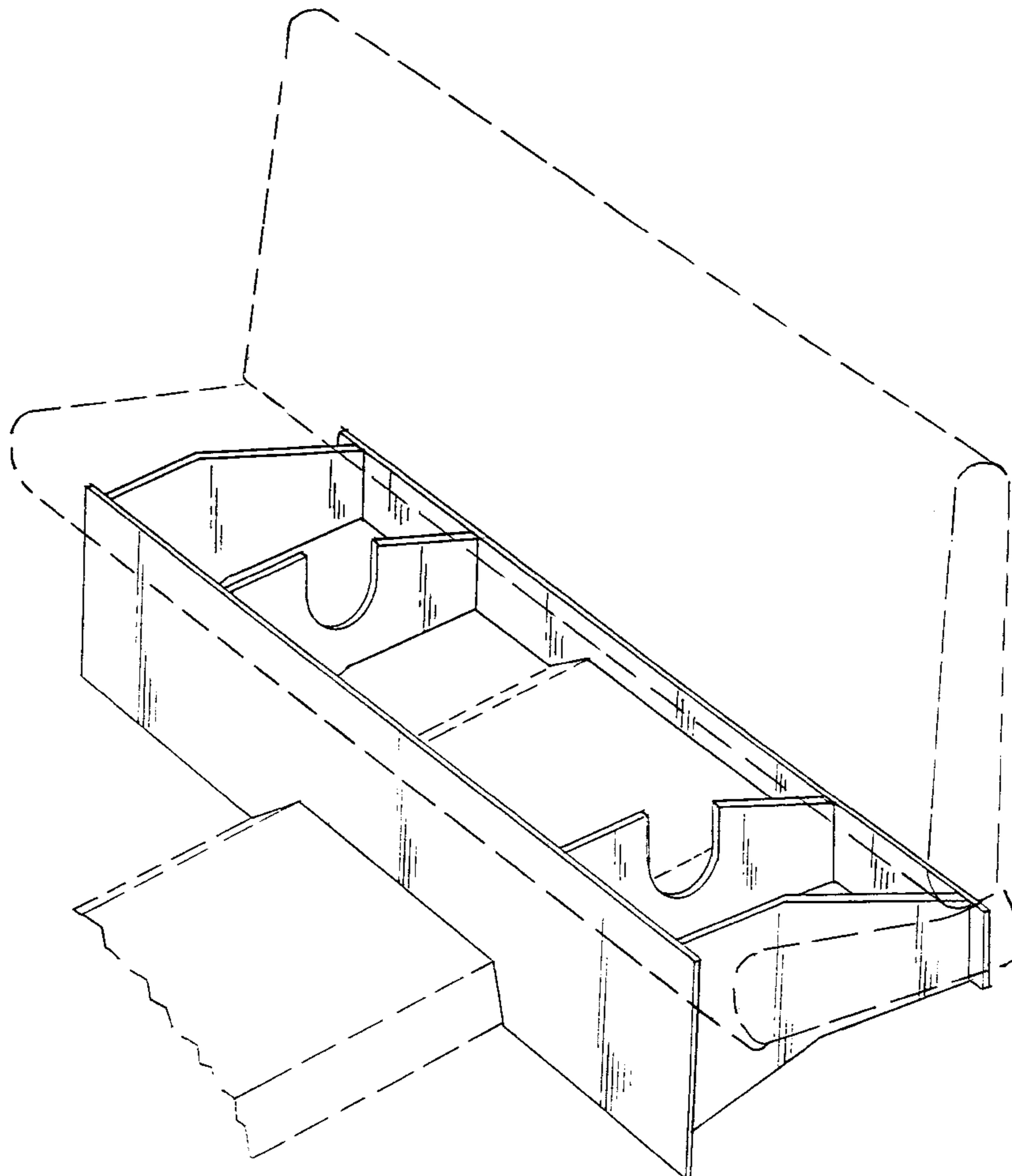

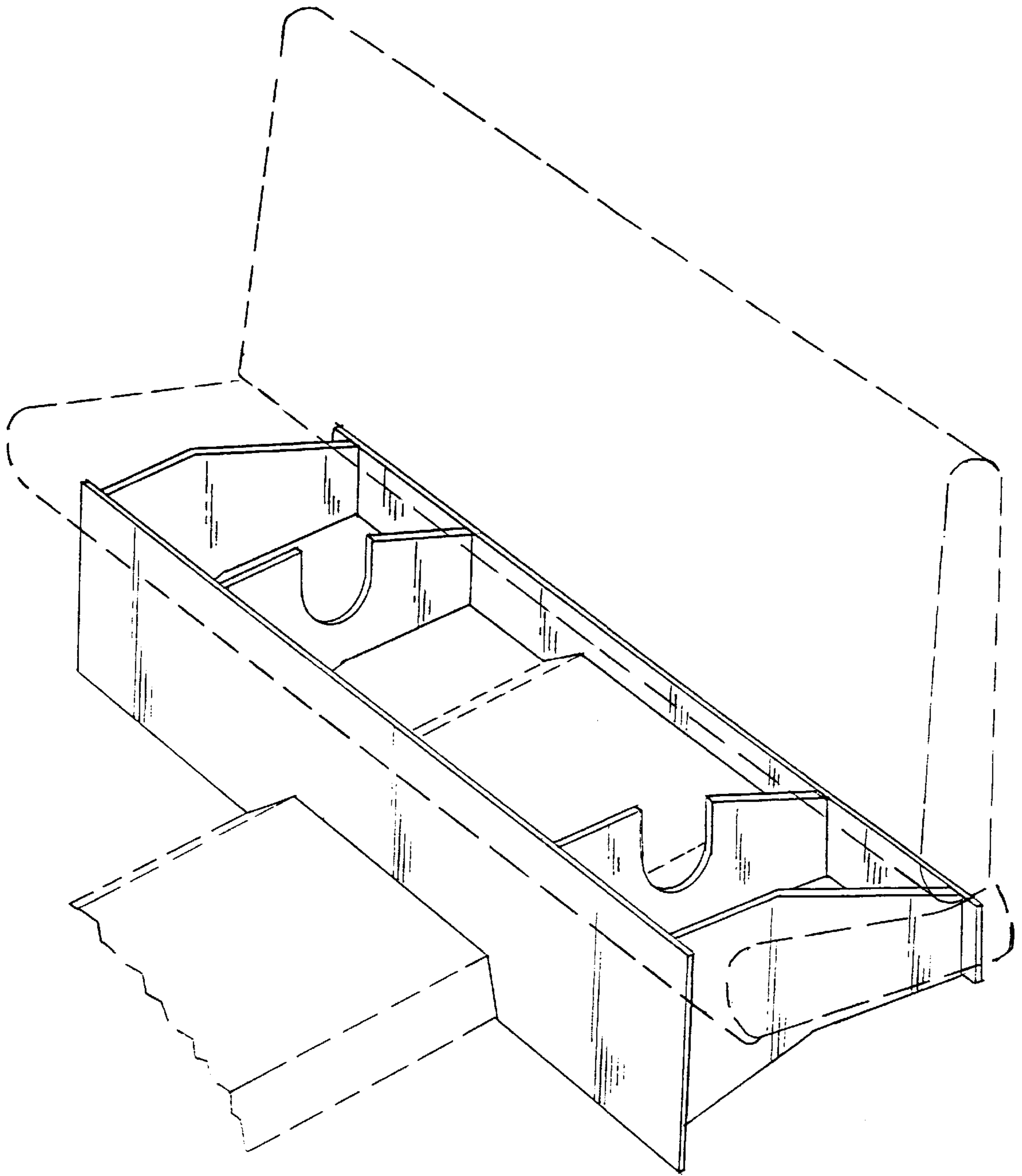

FIG. 1

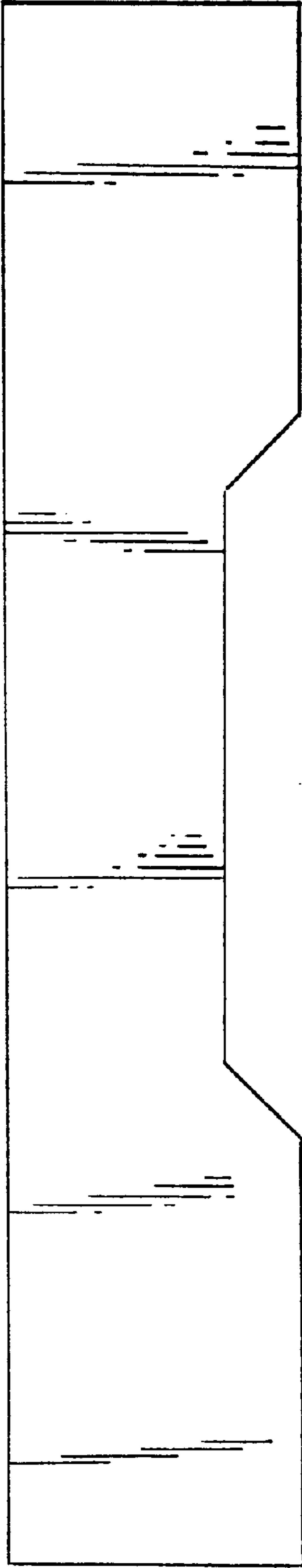

FIG. 2

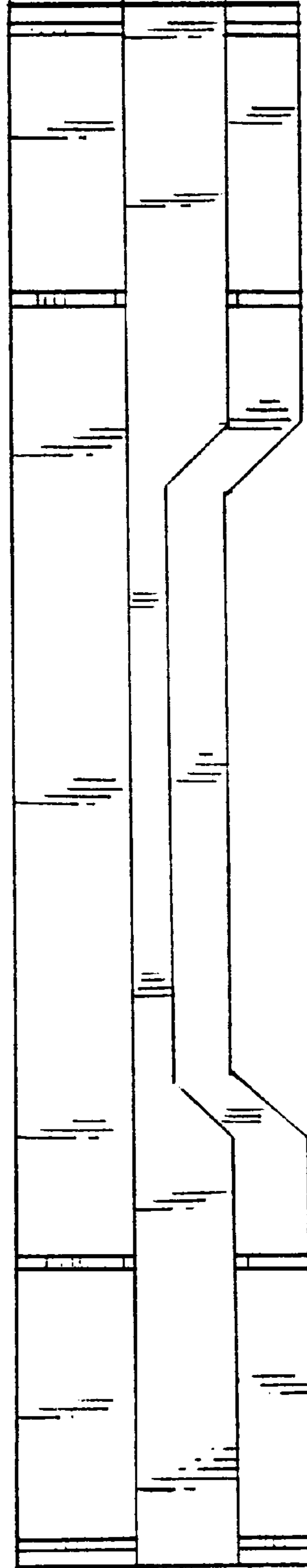
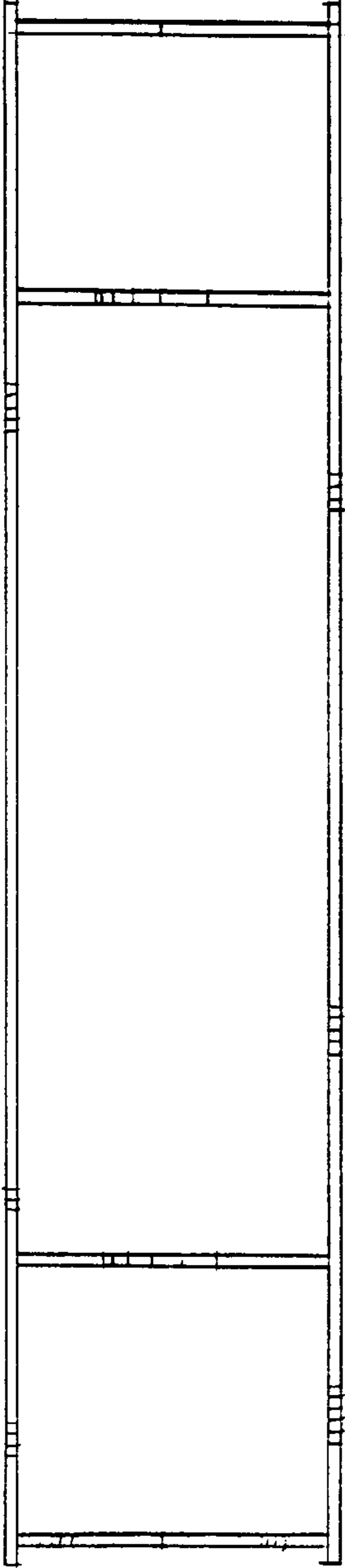
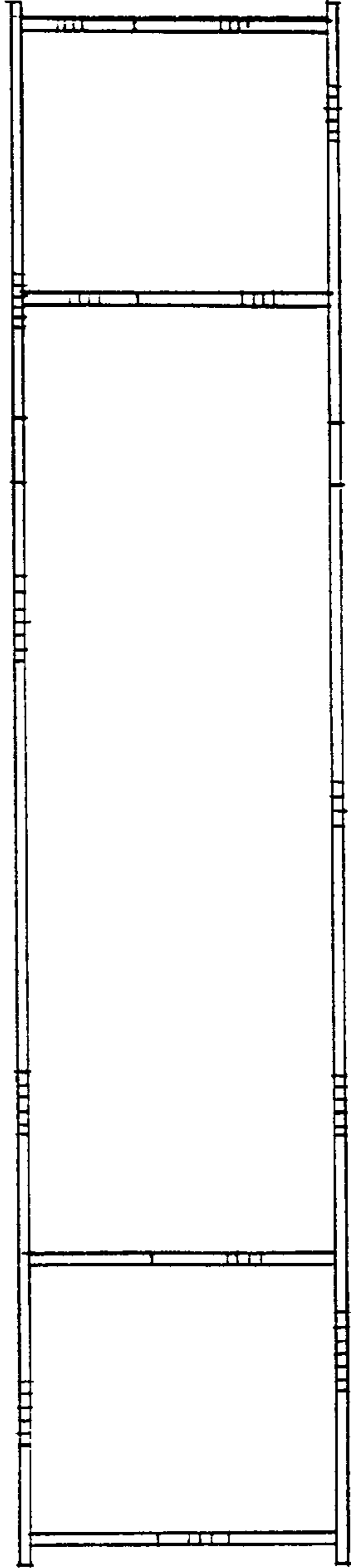

FIG. 3



*FIG. 4*



*FIG. 5*

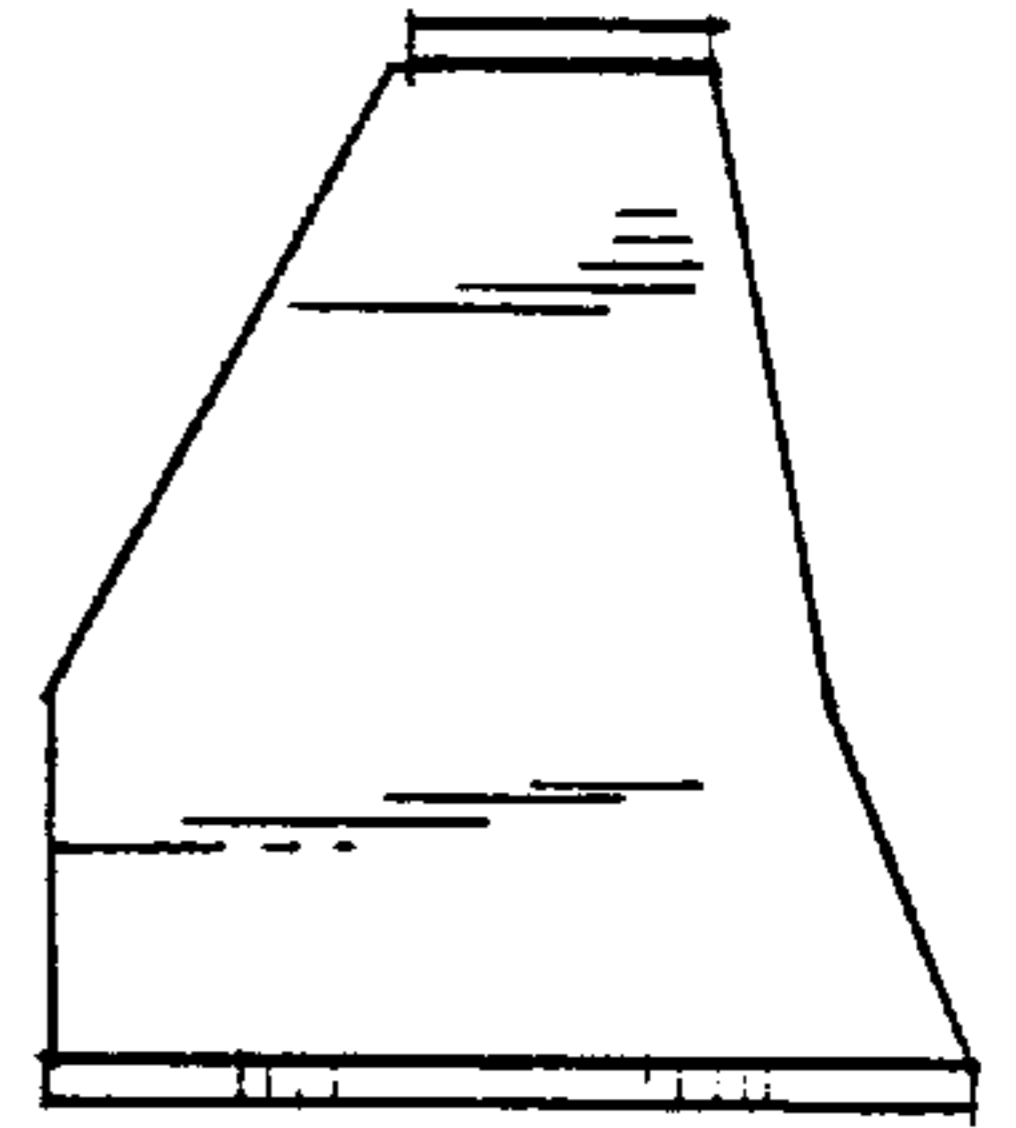

*FIG. 6*

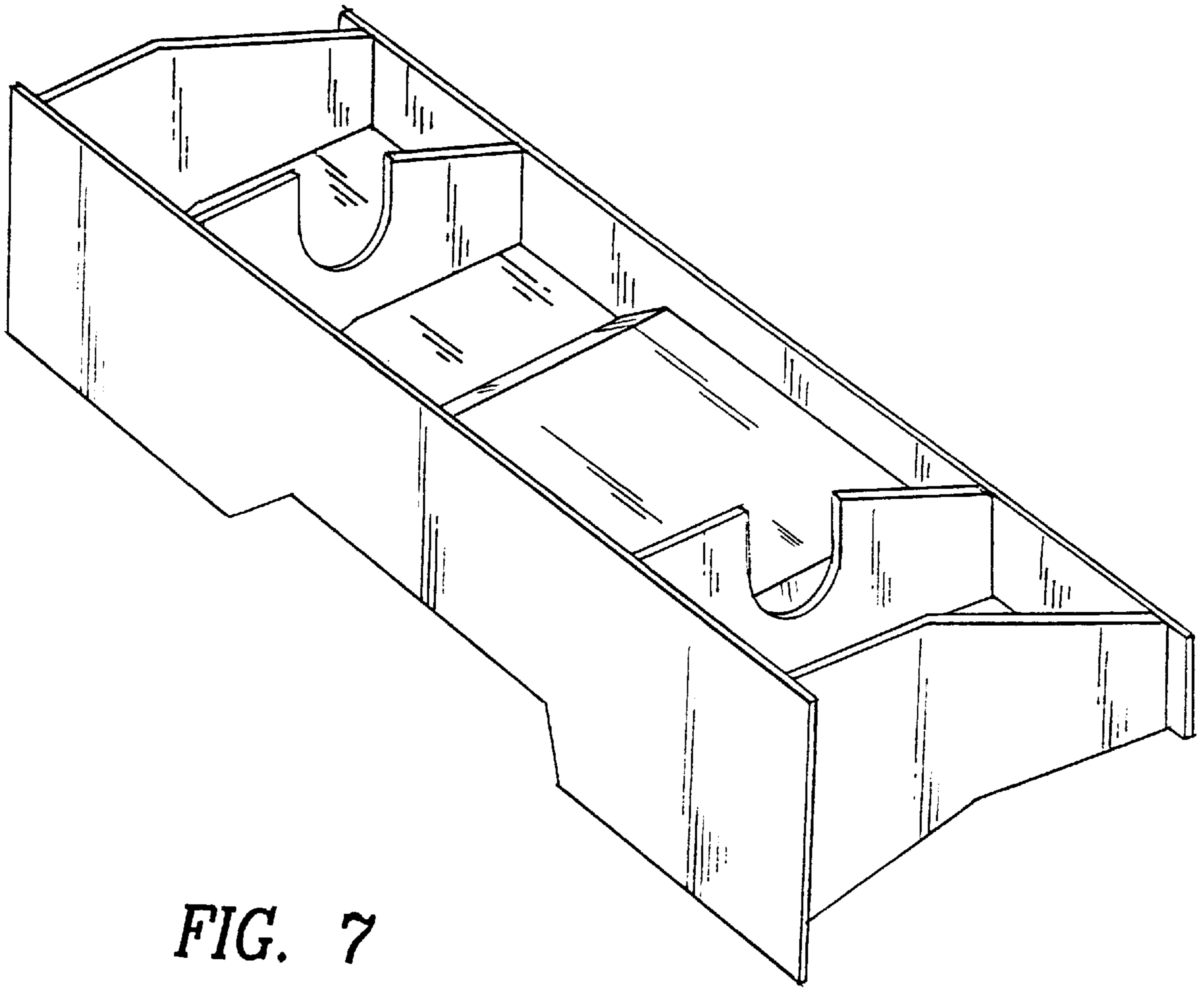

*FIG. 7*

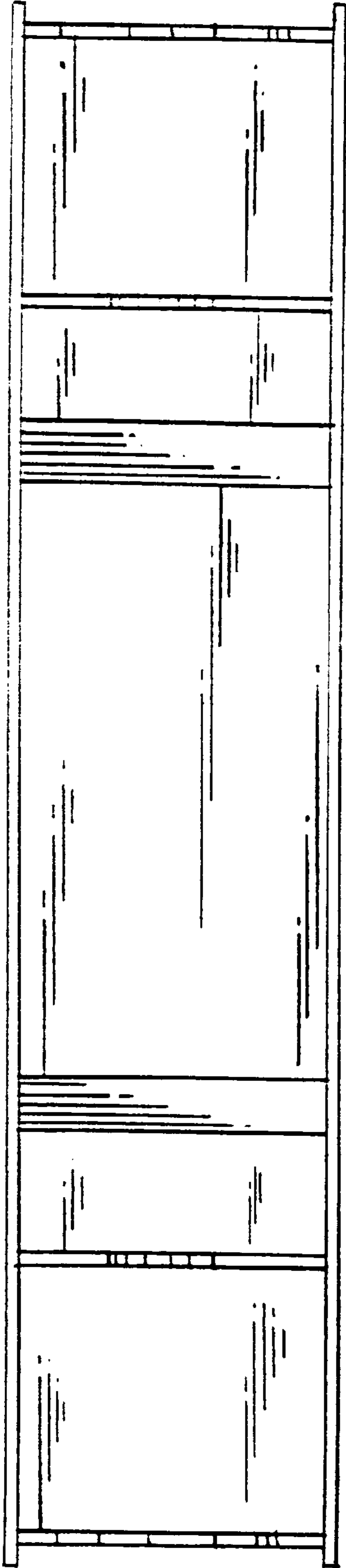

*FIG. 8*

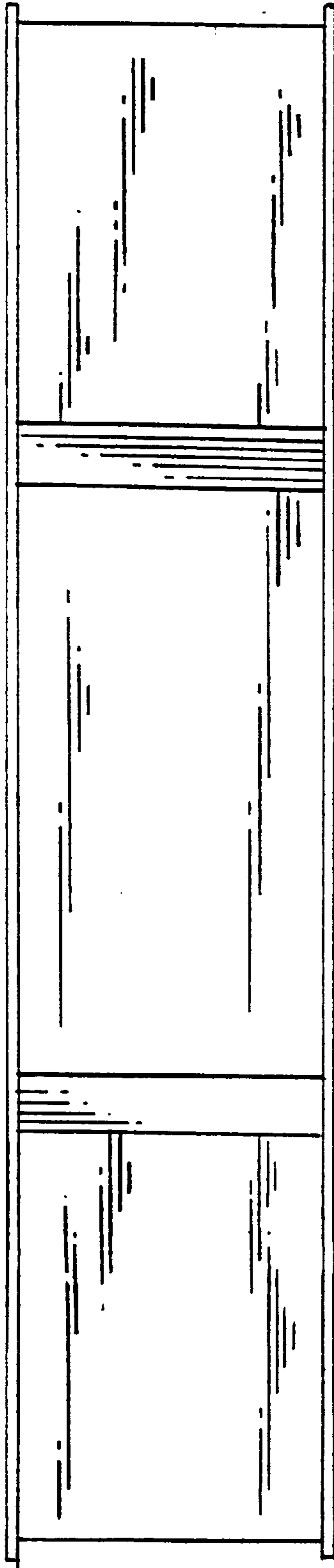

*FIG. 9*

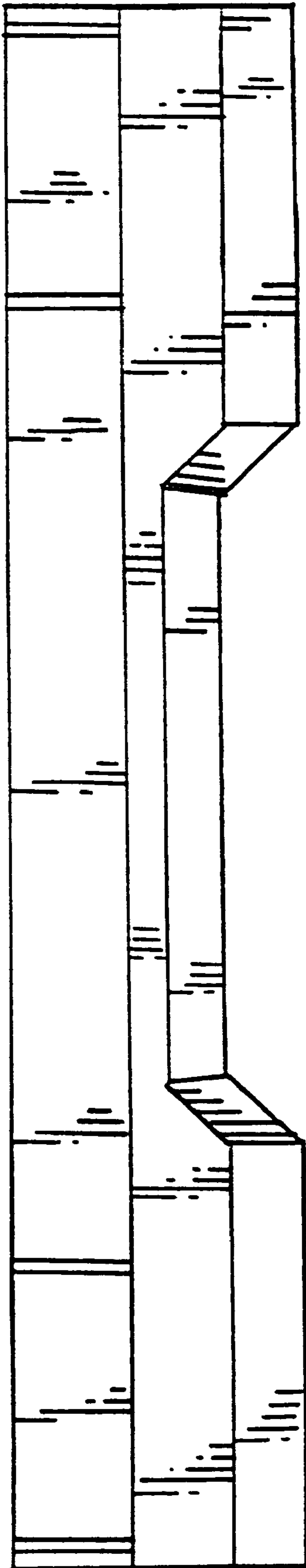

*FIG. 10*