



US00D428699S

United States Patent [19]

Gibson et al.

[11] Patent Number: **Des. 428,699**

[45] Date of Patent: **** Aug. 1, 2000**

[54] **CARRYING AND STORAGE CASE**

[75] Inventors: **Bob Gibson**, Charlotte; **Jamey Boiter**, Belmont; **John Baker**, Davidson; **John Bone**, Charlotte, all of N.C.

[73] Assignee: **LF Corporation**, Wilmington, Del.

[**] Term: **14 Years**

[21] Appl. No.: **29/108,963**

[22] Filed: **Aug. 6, 1999**

[51] **LOC (7) Cl.** **03-01**

[52] **U.S. Cl.** **D3/282; D3/276**

[58] **Field of Search** **D3/272, 273, 276, D3/281, 282, 294; 206/372, 373, 349, 379; 190/110, 111, 112**

[56] **References Cited**

U.S. PATENT DOCUMENTS

D. 314,669	2/1991	Kunimune	D3/282
D. 347,731	6/1994	Hayakawa et al.	D3/282
D. 362,546	9/1995	Mundorf et al.	D3/276
D. 368,371	4/1996	Calmeise	D3/282
D. 384,501	10/1997	Rosen	D3/282
D. 390,357	2/1998	Rosen	D3/282
D. 390,358	2/1998	Calmeisae	D3/282
D. 391,760	3/1998	Zeller	D3/281
D. 393,945	5/1998	Urvoy	D3/282
D. 399,652	10/1998	Fang	D3/282
D. 406,192	3/1999	Schurman	D3/282
D. 413,440	9/1999	Schurman	D3/282
4,998,616	3/1991	Hillinger	206/372
5,114,007	5/1992	Chen	203/373
5,145,064	9/1992	Chen	206/373

Primary Examiner—Philip S. Hyder

Attorney, Agent, or Firm—Alston & Bird LLP

[57] **CLAIM**

The ornamental design for a carrying and storage case, as shown and described.

DESCRIPTION

FIG. 1 is a perspective view of a carrying and storage case in accordance with a first embodiment of the new design; FIG. 2 is front elevation of the carrying and storage case of FIG. 1; FIG. 3 is rear elevation of the carrying and storage case of FIG. 1; FIG. 4 is a left-side elevation of the carrying and storage case of FIG. 1; FIG. 5 is a right-side elevation of the carrying and storage case of FIG. 1; FIG. 6 is a top elevation of the carrying and storage case of FIG. 1; FIG. 7 is a bottom elevation of the carrying and storage case of FIG. 1; FIG. 8 is a perspective view of a carrying and storage case in accordance with a second embodiment of the new design; FIG. 9 is front elevation of the carrying and storage case of FIG. 8; FIG. 10 is rear elevation of the carrying and storage case of FIG. 8; FIG. 11 is a left-side elevation of the carrying and storage case of FIG. 8; FIG. 12 is a right-side elevation of the carrying and storage case of FIG. 8; FIG. 13 is top elevation of the carrying and storage case of FIG. 8; and, FIG. 14 is a bottom elevation of the carrying and storage case of FIG. 8.

1 Claim, 6 Drawing Sheets

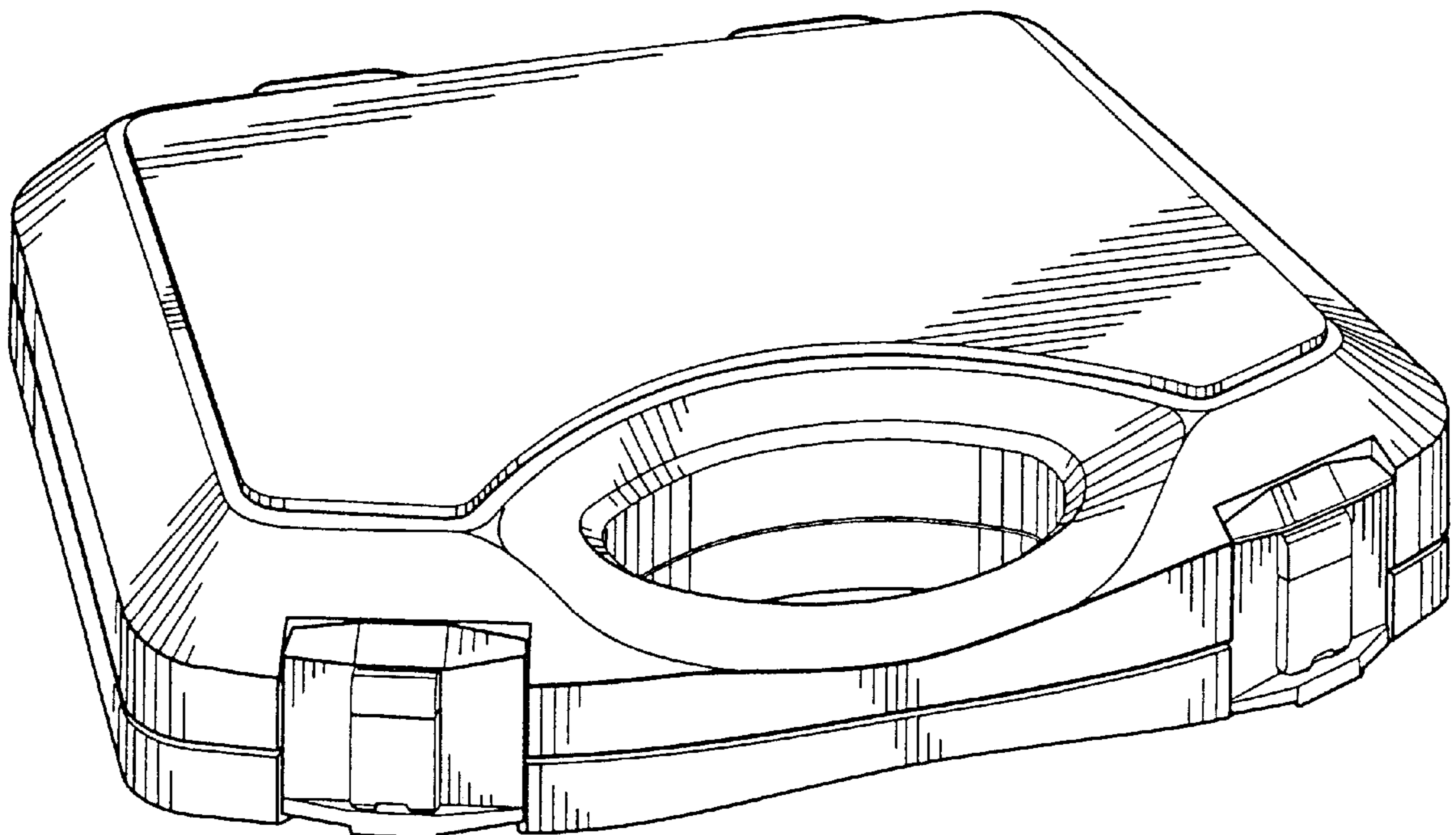

FIG. 1

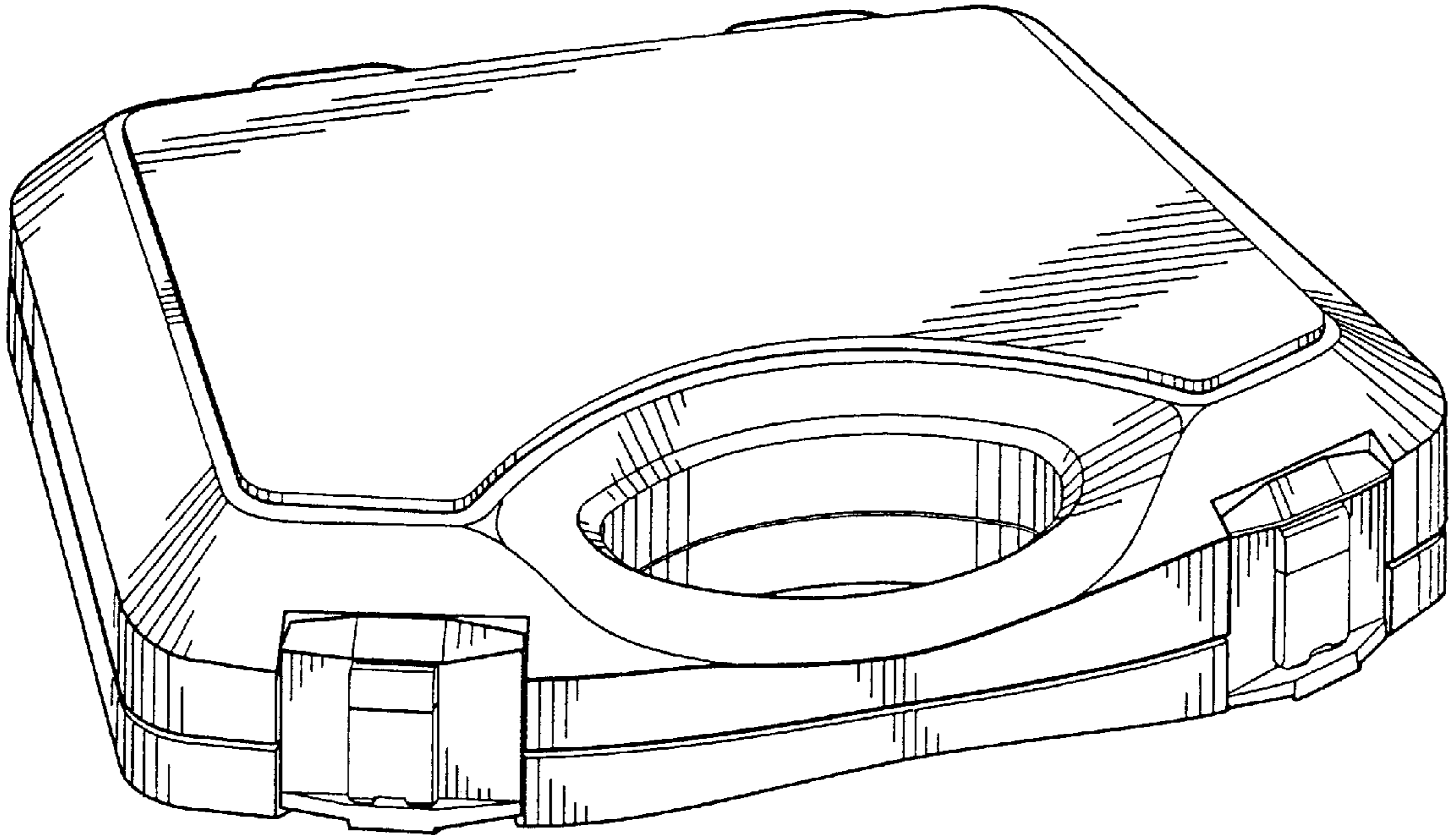

FIG. 2

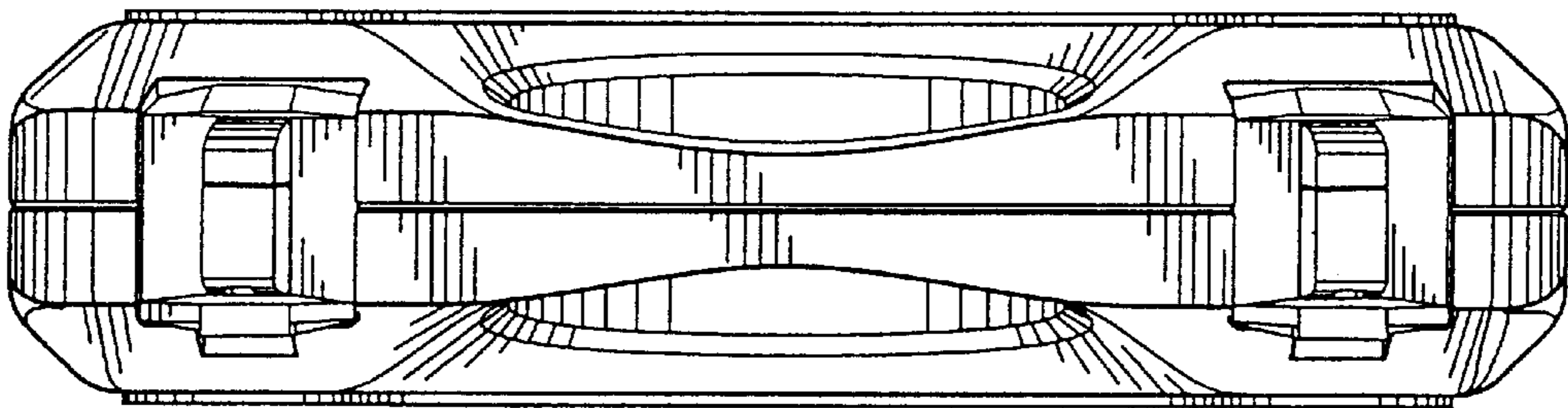

FIG. 3

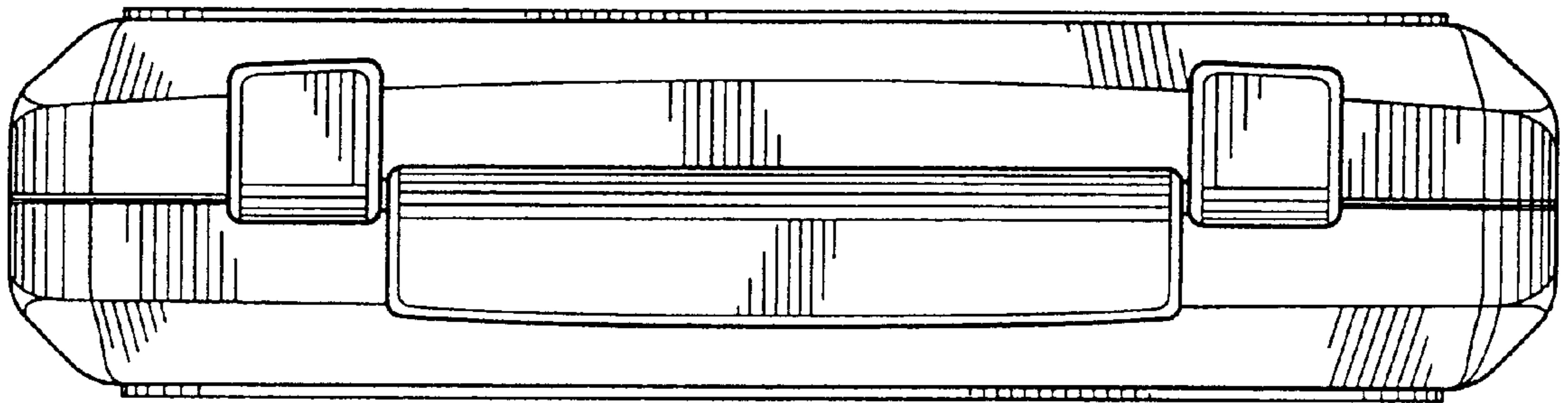

FIG. 4

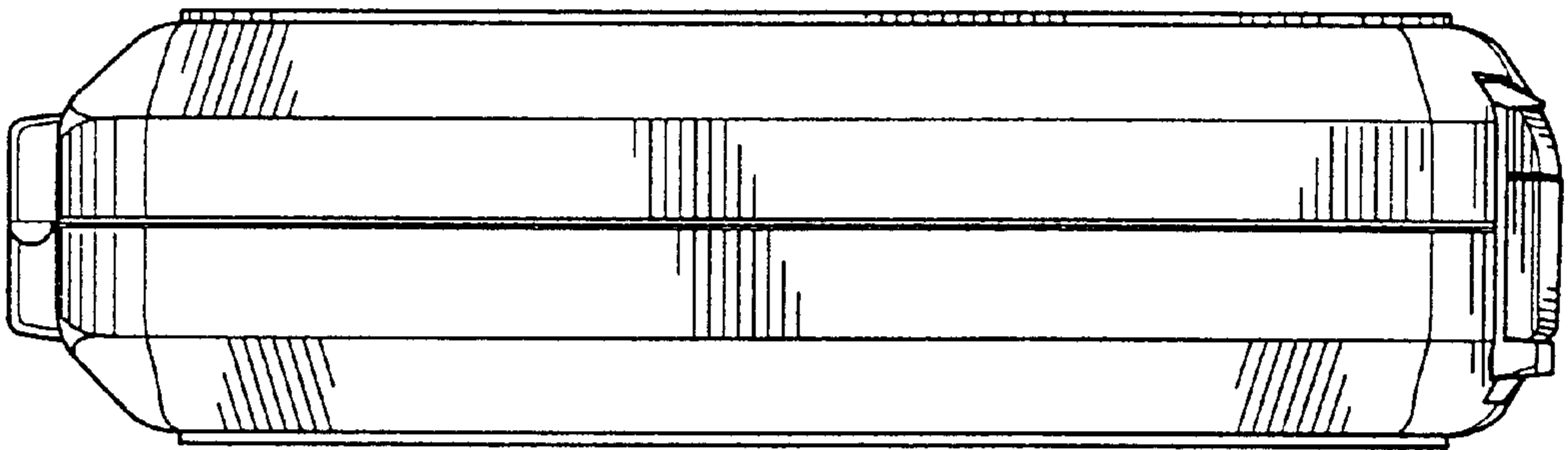

FIG. 5

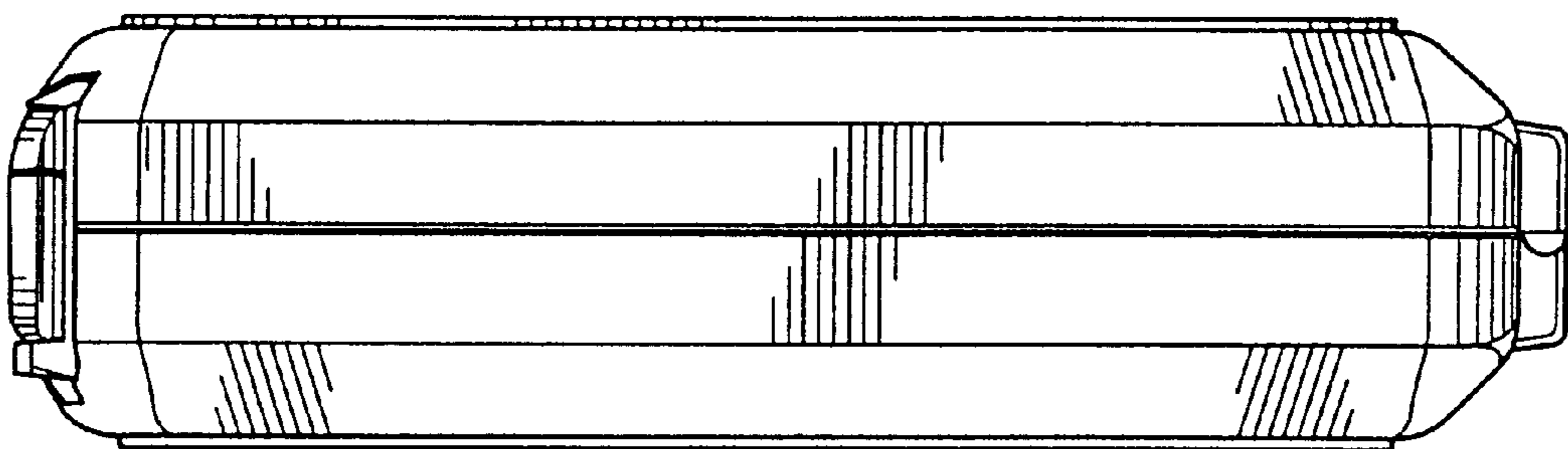

FIG. 6

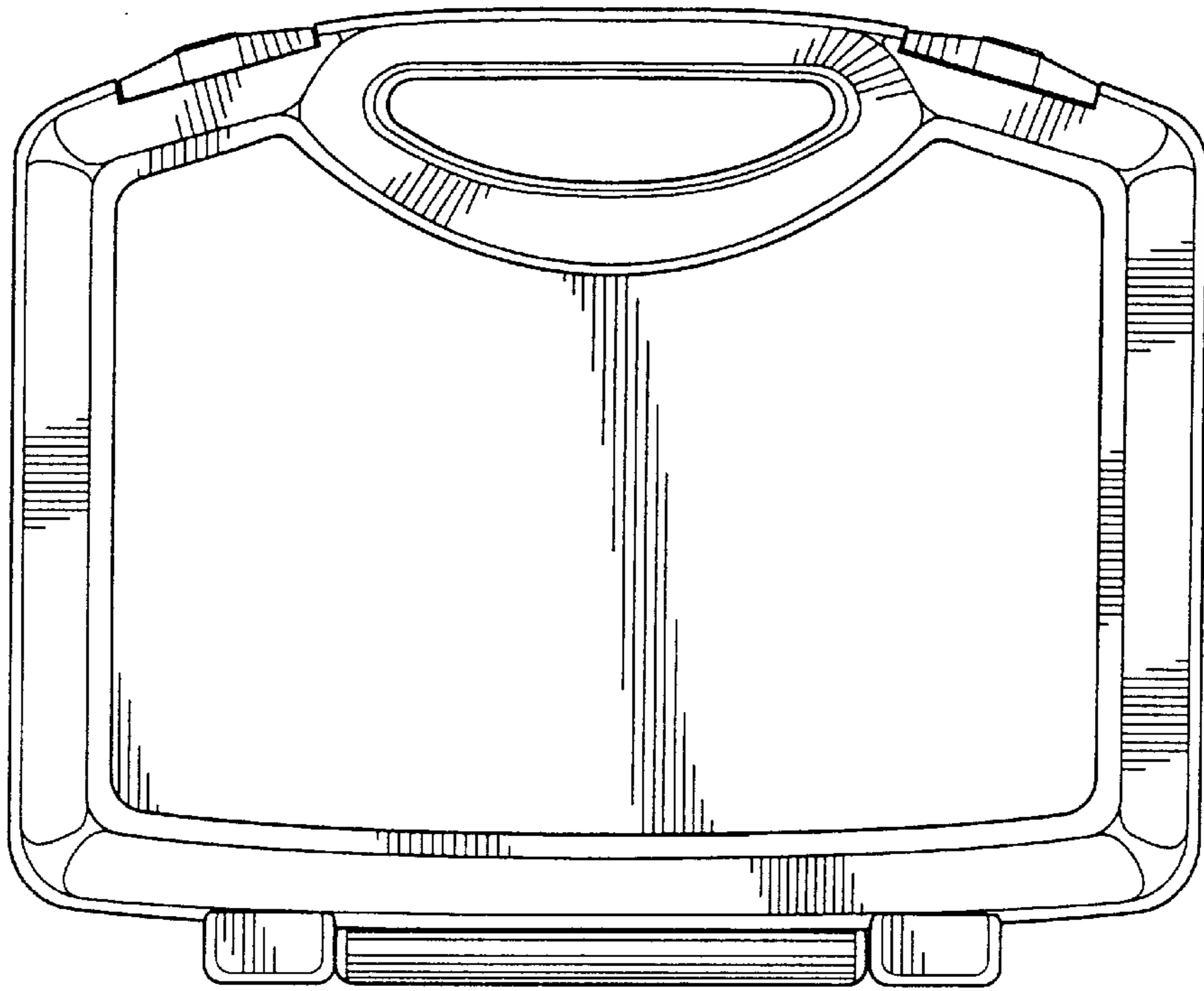

FIG. 7

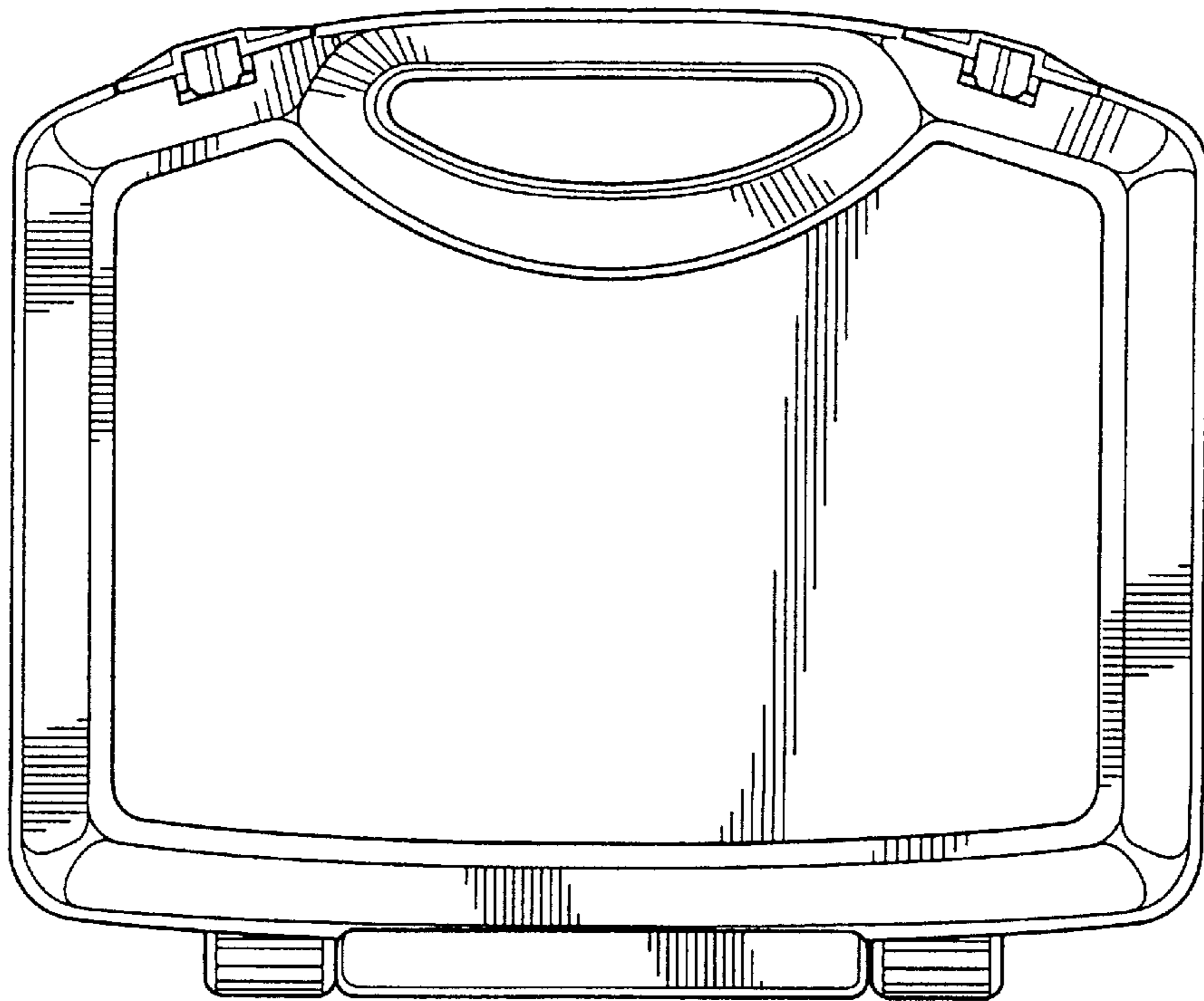

FIG. 8

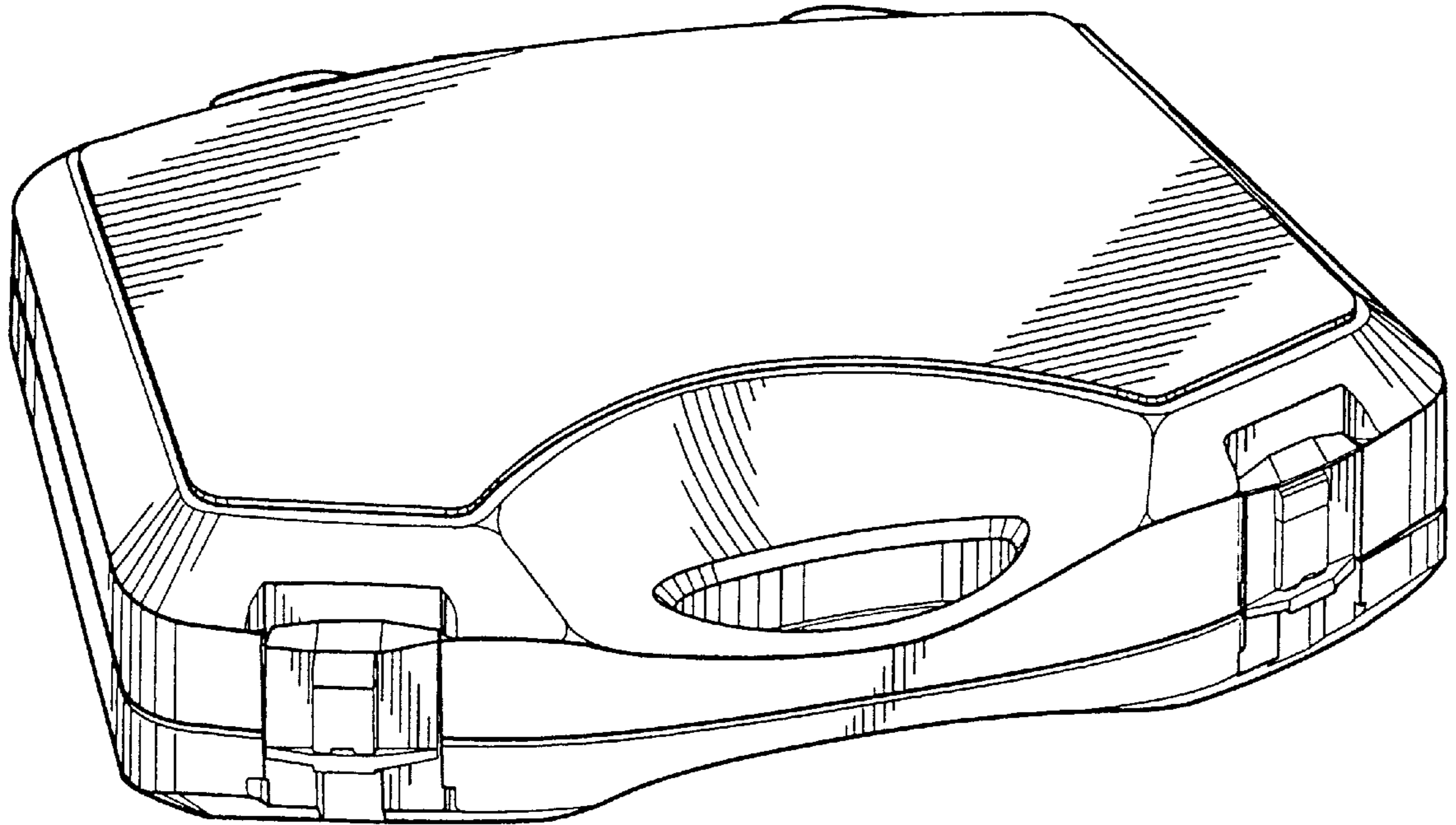

FIG. 9

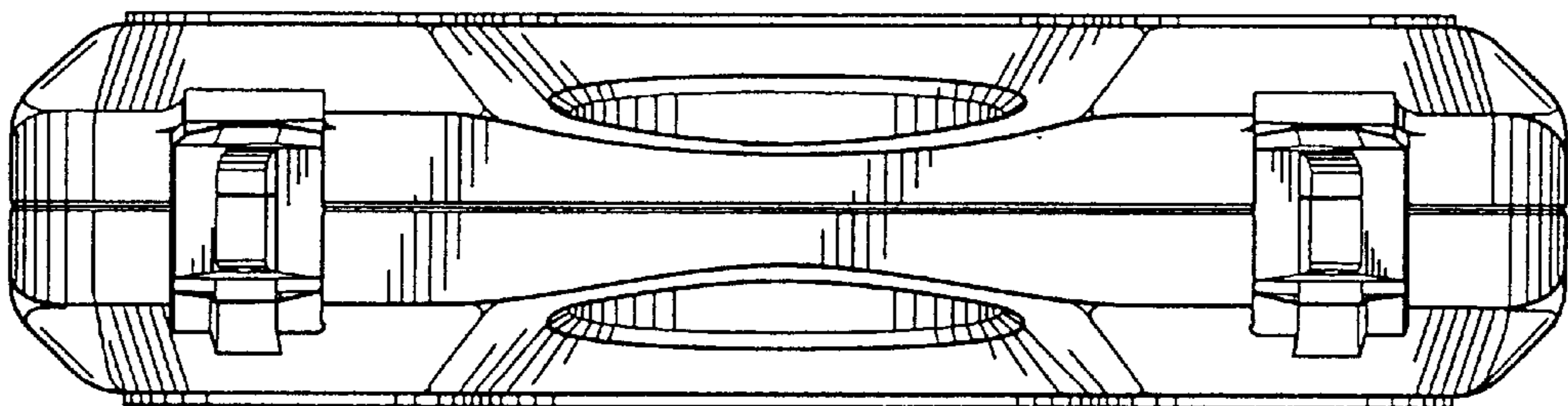

FIG. 10

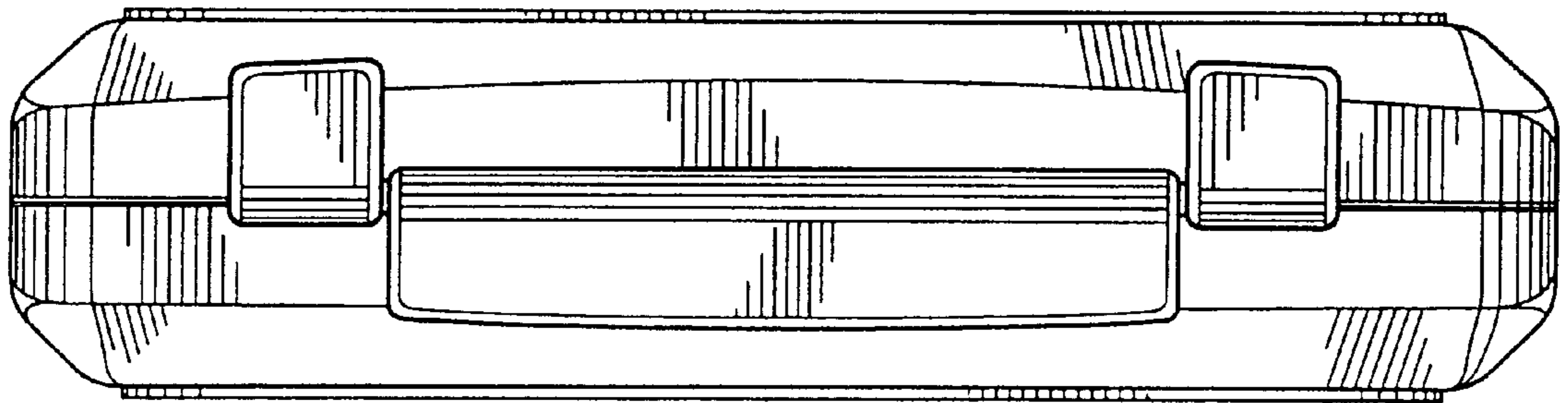

FIG. 11

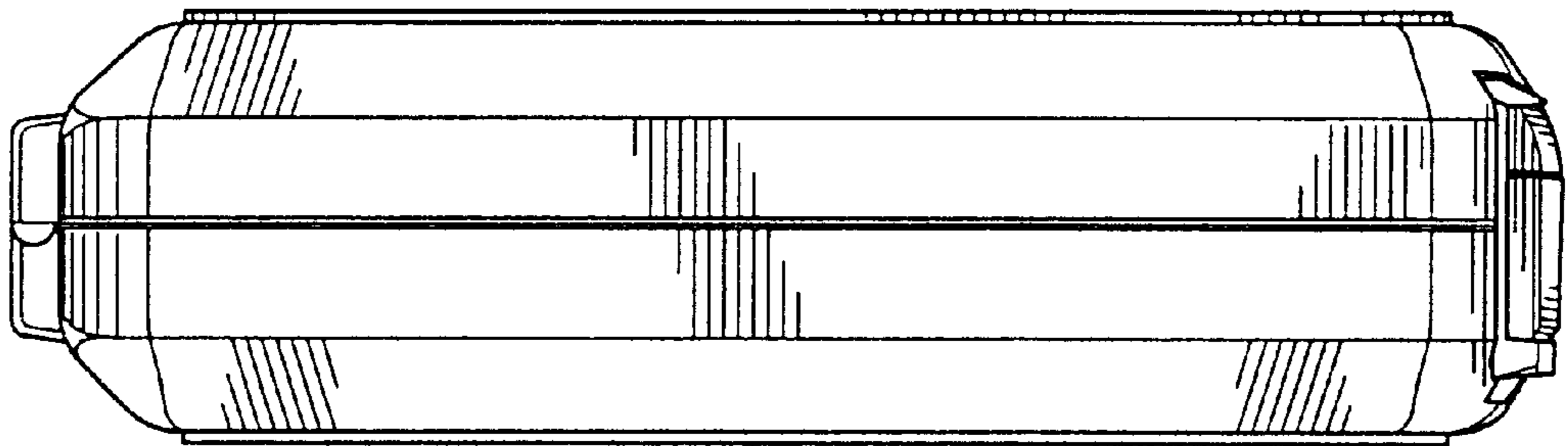

FIG. 12

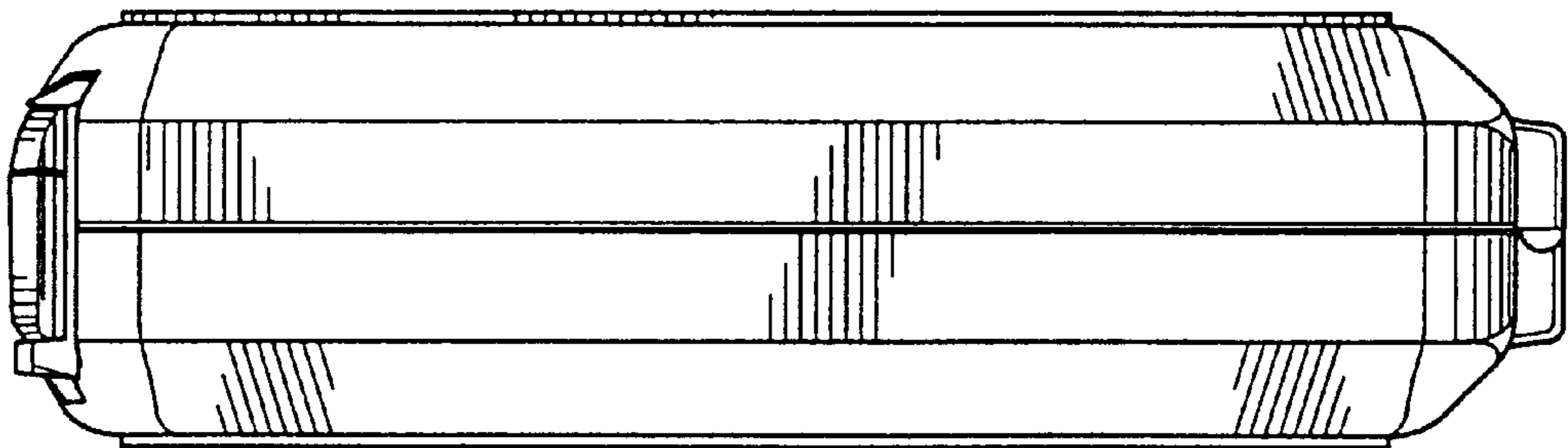

FIG. 13

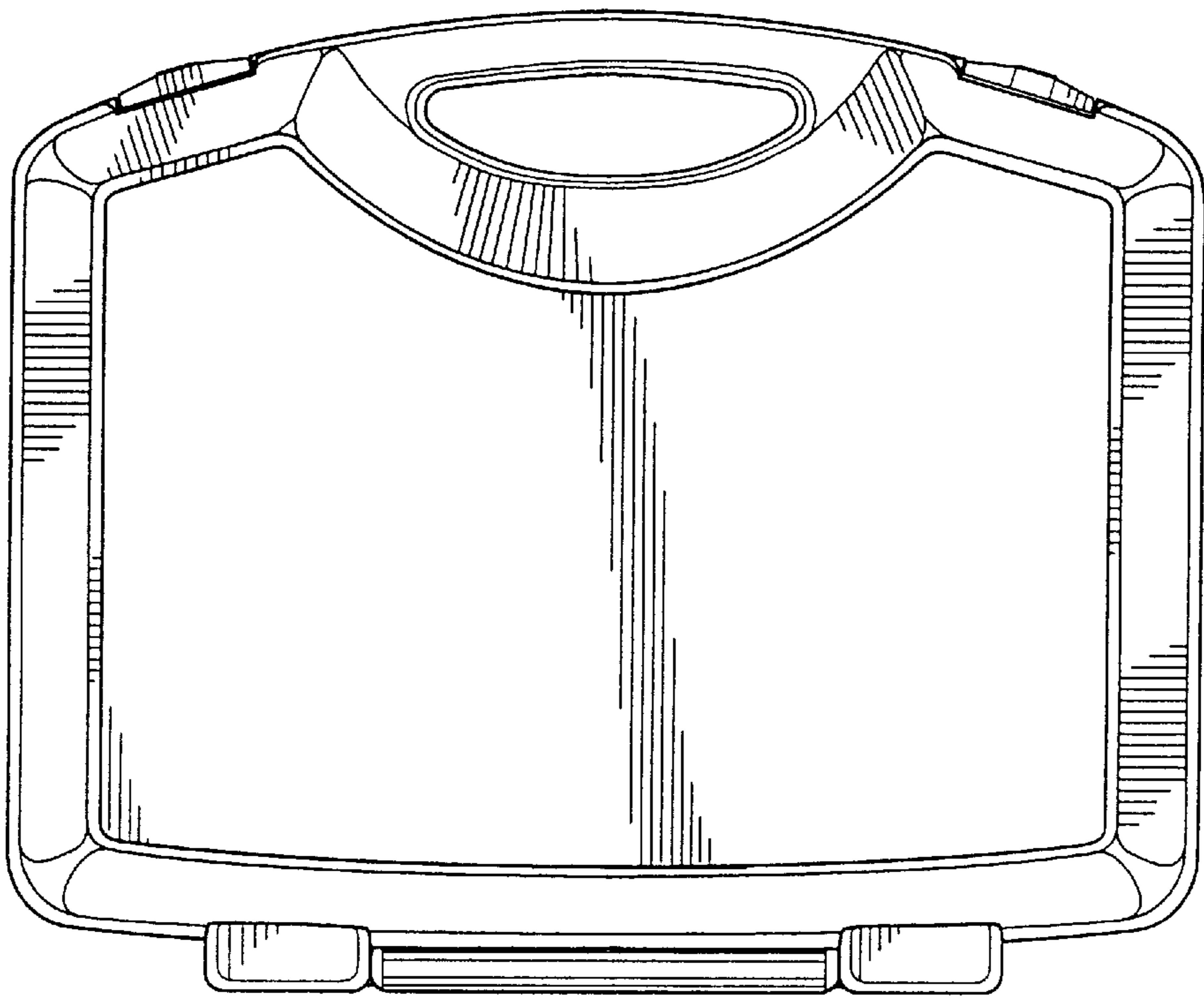

FIG. 14

