



US00D428698S

# United States Patent [19] Cheng

[11] Patent Number: **Des. 428,698**

[45] Date of Patent: **\*\* Aug. 1, 2000**

[54] **LUGGAGE CASE**

[75] Inventor: **Koon-Ming Cheng**, Taipei, Taiwan

[73] Assignee: **Ruey Yuan Co., Ltd.**, Taipei, Japan

[\*\*] Term: **14 Years**

[21] Appl. No.: **29/111,486**

[22] Filed: **Sep. 30, 1999**

[30] **Foreign Application Priority Data**

Mar. 31, 1999 [TW] Taiwan ..... 88301971

[51] **LOC (7) Cl.** ..... **03-01**

[52] **U.S. Cl.** ..... **D3/279; D3/276**

[58] **Field of Search** ..... D3/273, 276, 279,  
D3/281, 282; 190/18 A, 110, 111, 112,  
113, 115

[56] **References Cited**

**U.S. PATENT DOCUMENTS**

D. 285,145 8/1986 Hsieh ..... D3/279  
D. 333,914 3/1993 Van Hove et al. .... D3/279  
D. 348,780 7/1994 Masaru ..... D3/279

D. 360,756 8/1995 King ..... D3/279  
D. 373,246 9/1996 Stokes et al. .... D3/279  
D. 383,603 9/1997 Pedlar ..... D3/279  
D. 383,905 9/1997 Stokes et al. .... D3/279  
D. 413,727 9/1999 Sijmons ..... D3/276

*Primary Examiner*—Philip S. Hyder  
*Attorney, Agent, or Firm*—Dickstein Shapiro Morin &  
Oshinsky LLP

[57] **CLAIM**

The ornamental design for luggage case, as shown and described.

**DESCRIPTION**

FIG. 1 is a perspective view of luggage case showing my new design;  
FIG. 2 is a front elevational view thereof;  
FIG. 3 is a rear elevational view thereof;  
FIG. 4 is a left side elevational view thereof;  
FIG. 5 is a right side elevational view thereof;  
FIG. 6 is a top plan view thereof;  
FIG. 7 is a bottom plan view thereof; and,  
FIG. 8 is a perspective view, when the handle is extended.

**1 Claim, 7 Drawing Sheets**

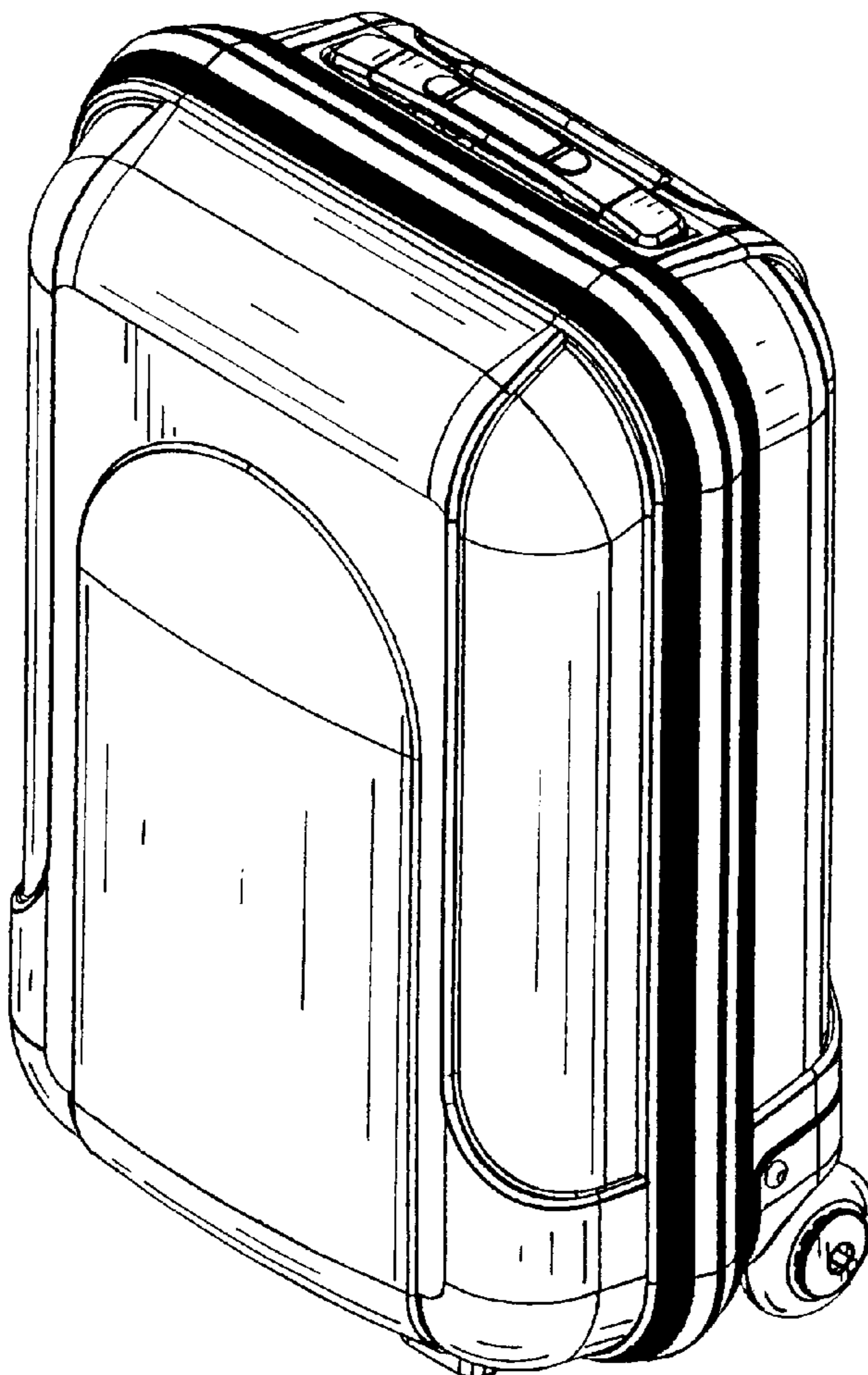

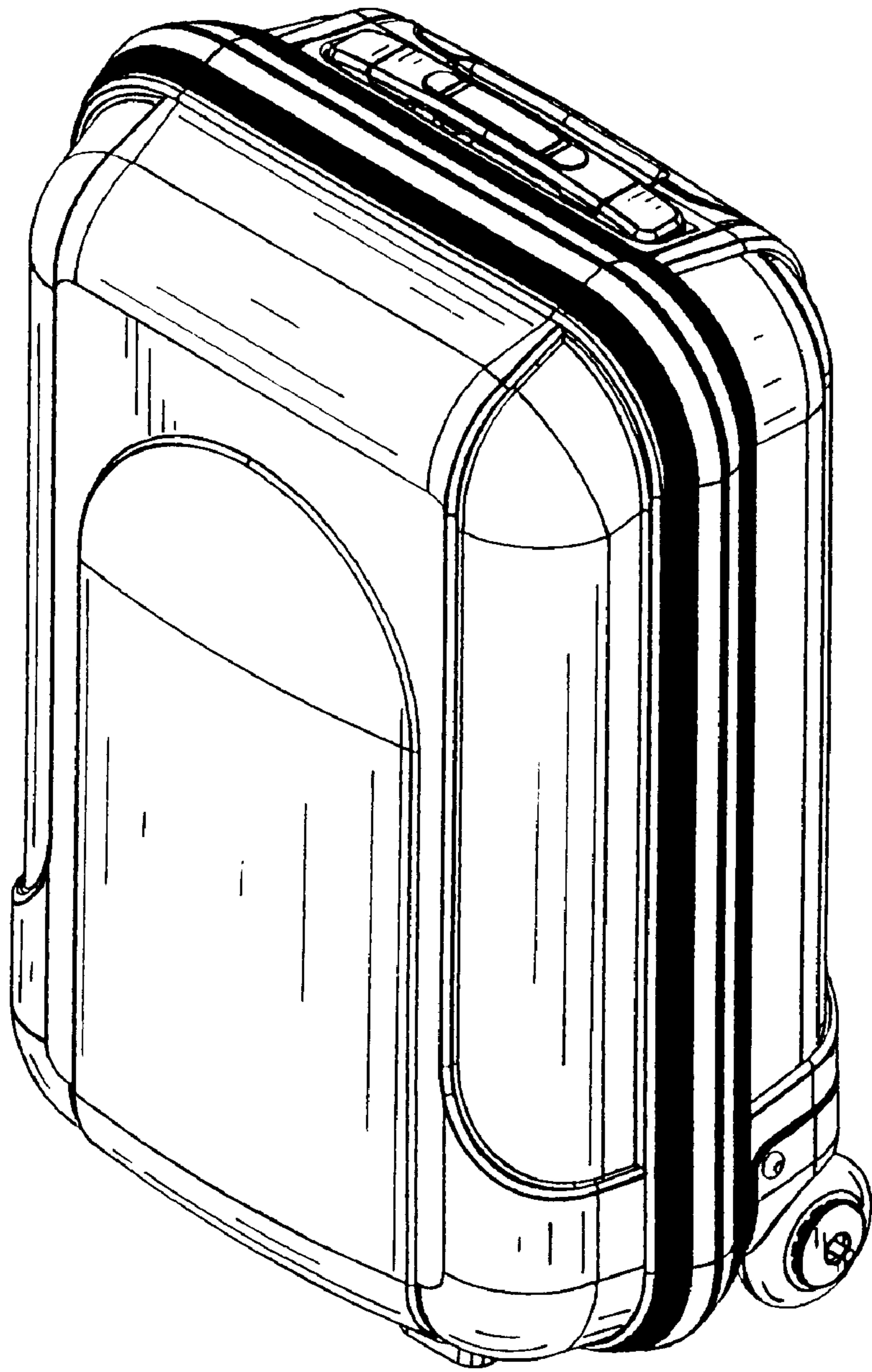

FIG. 1

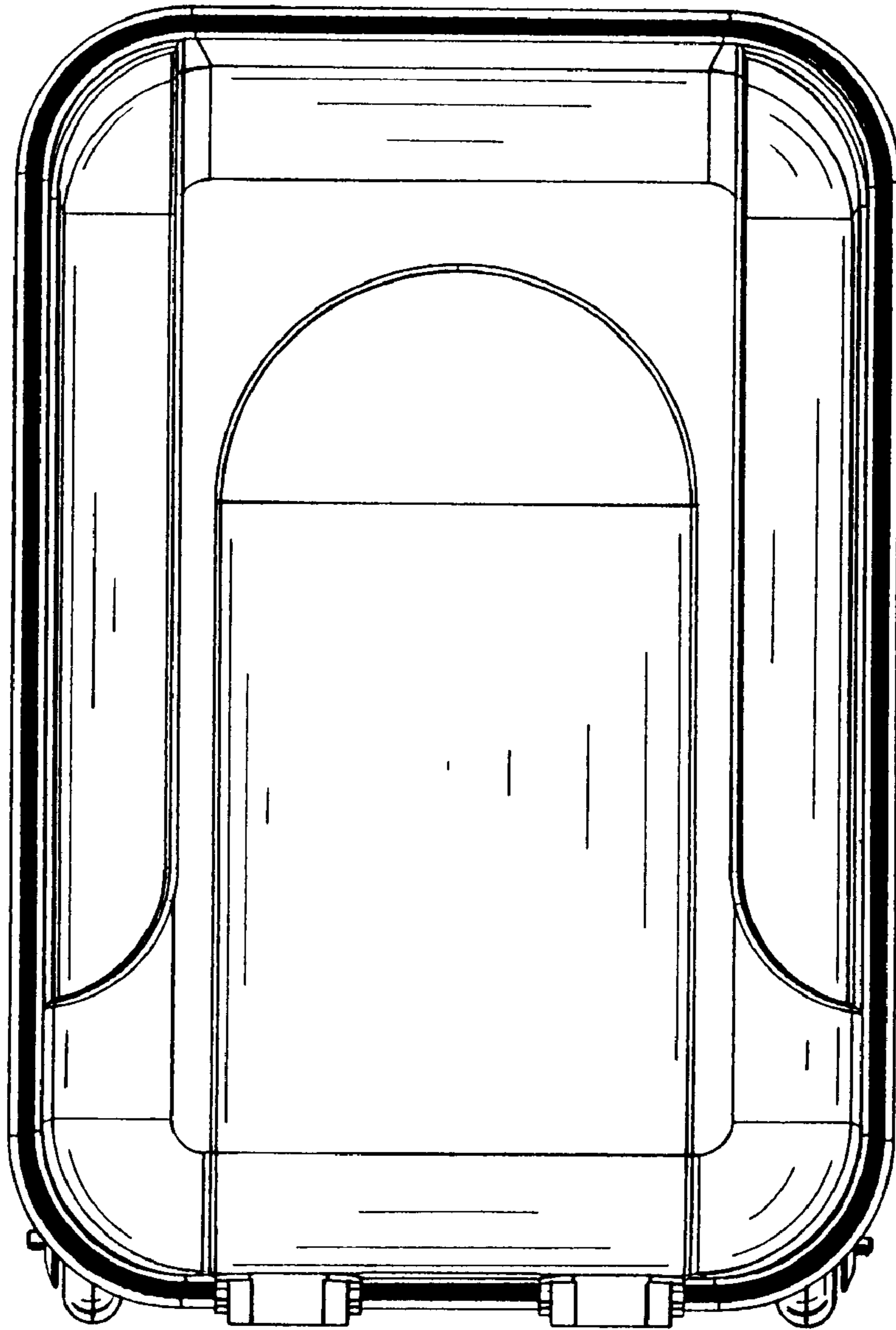

FIG. 2

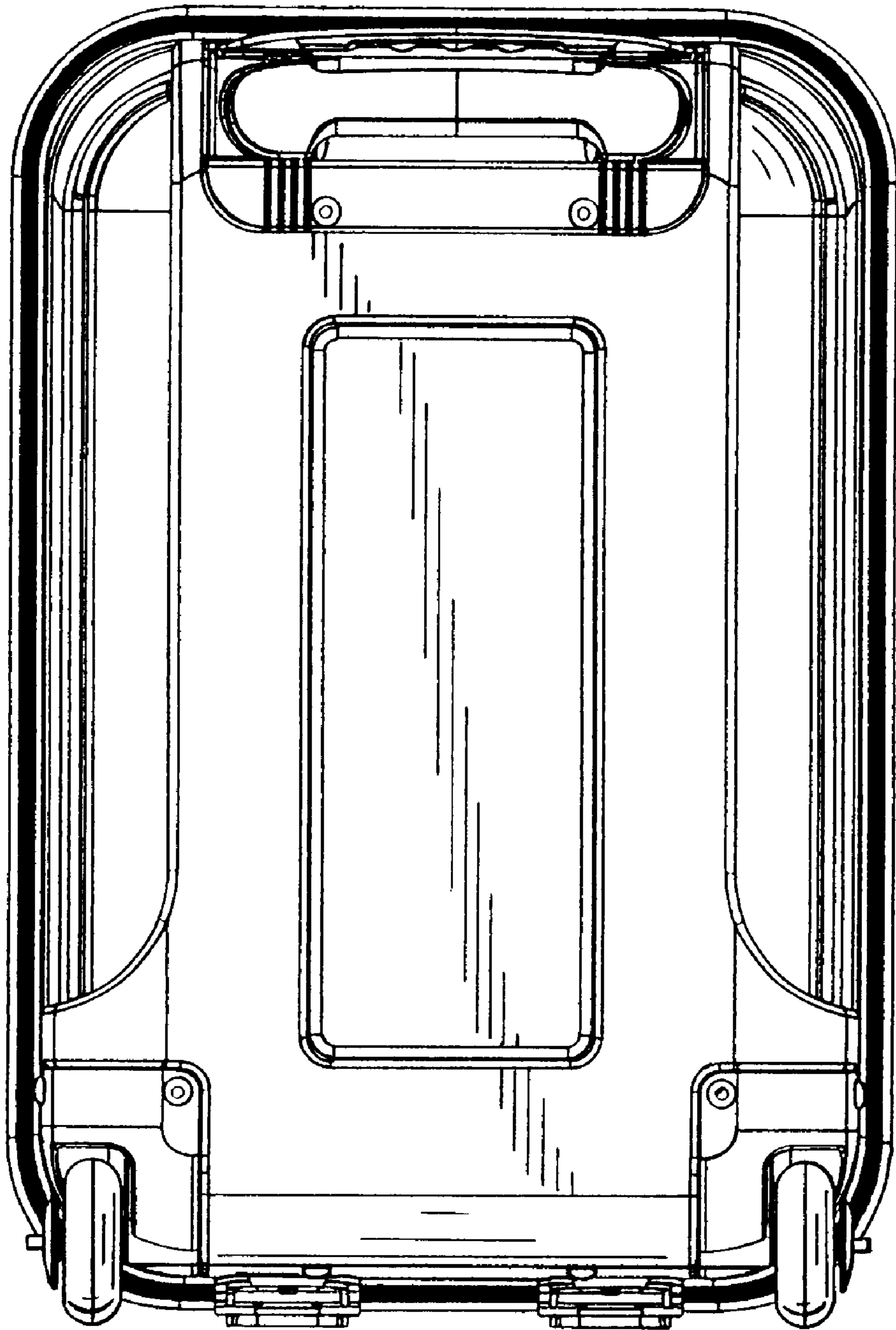

FIG. 3

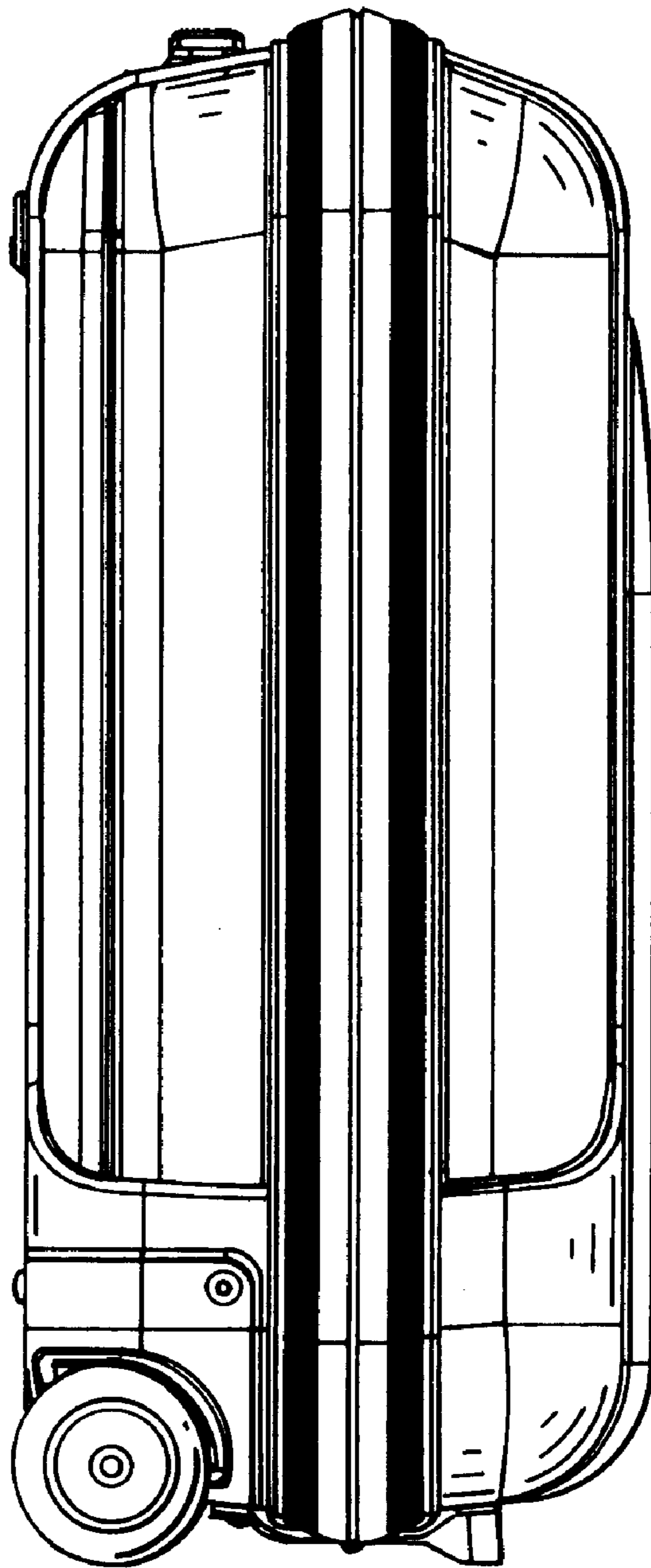

FIG. 4

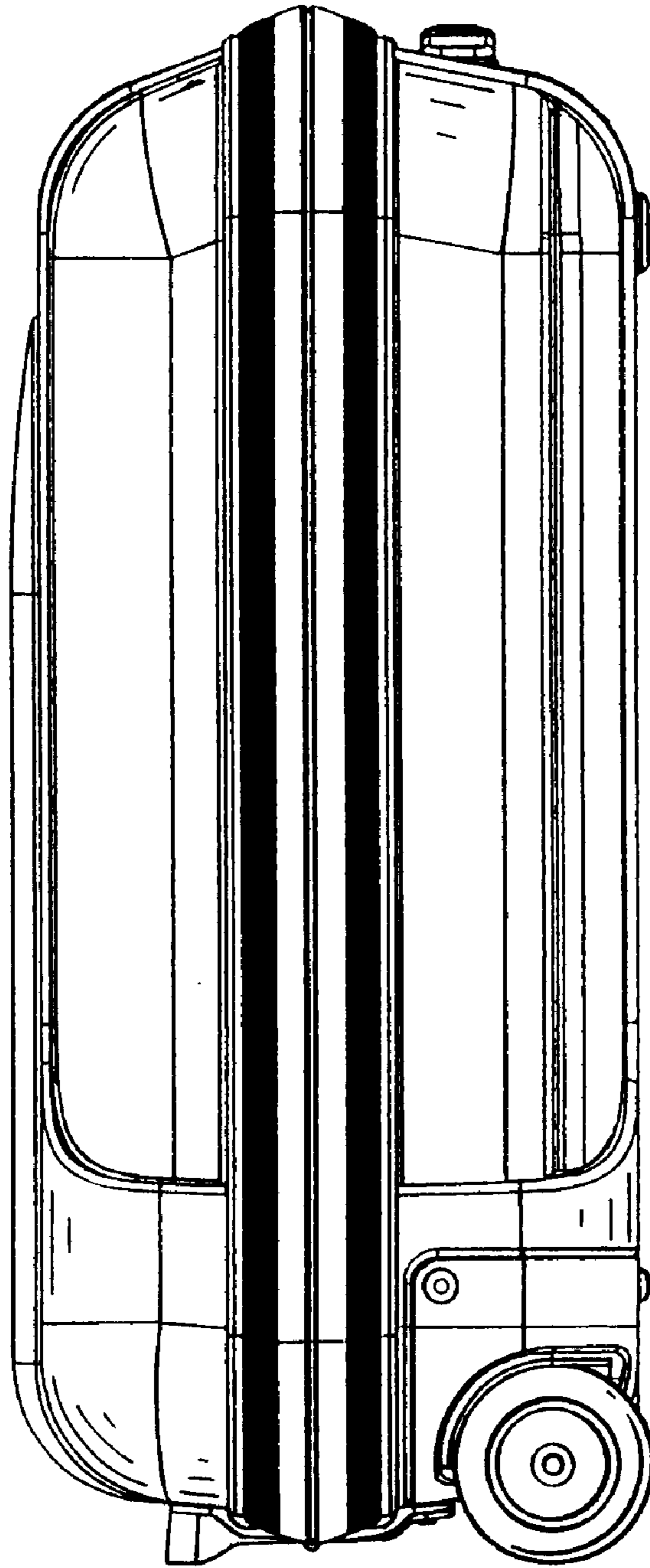

FIG. 5

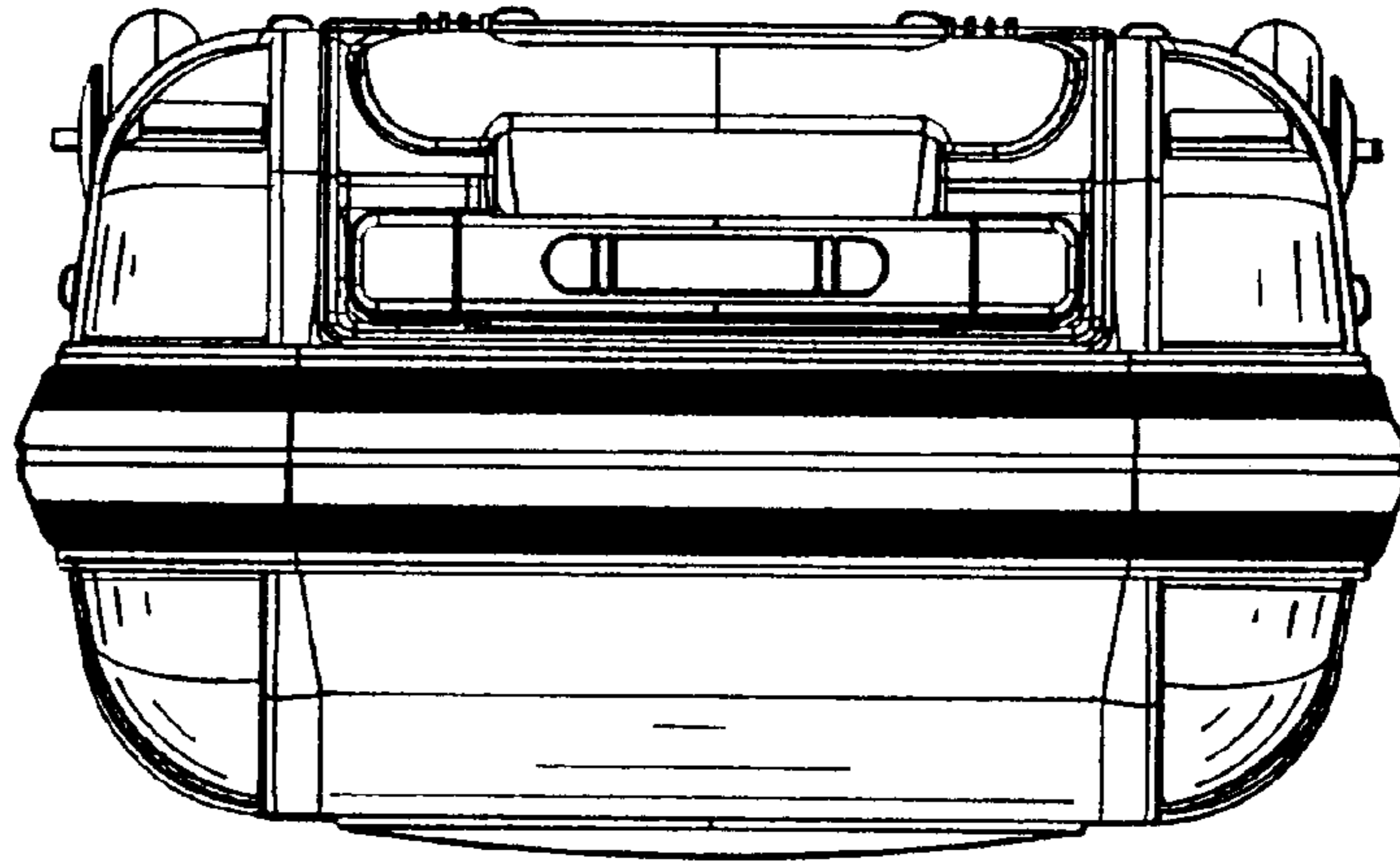

FIG. 6

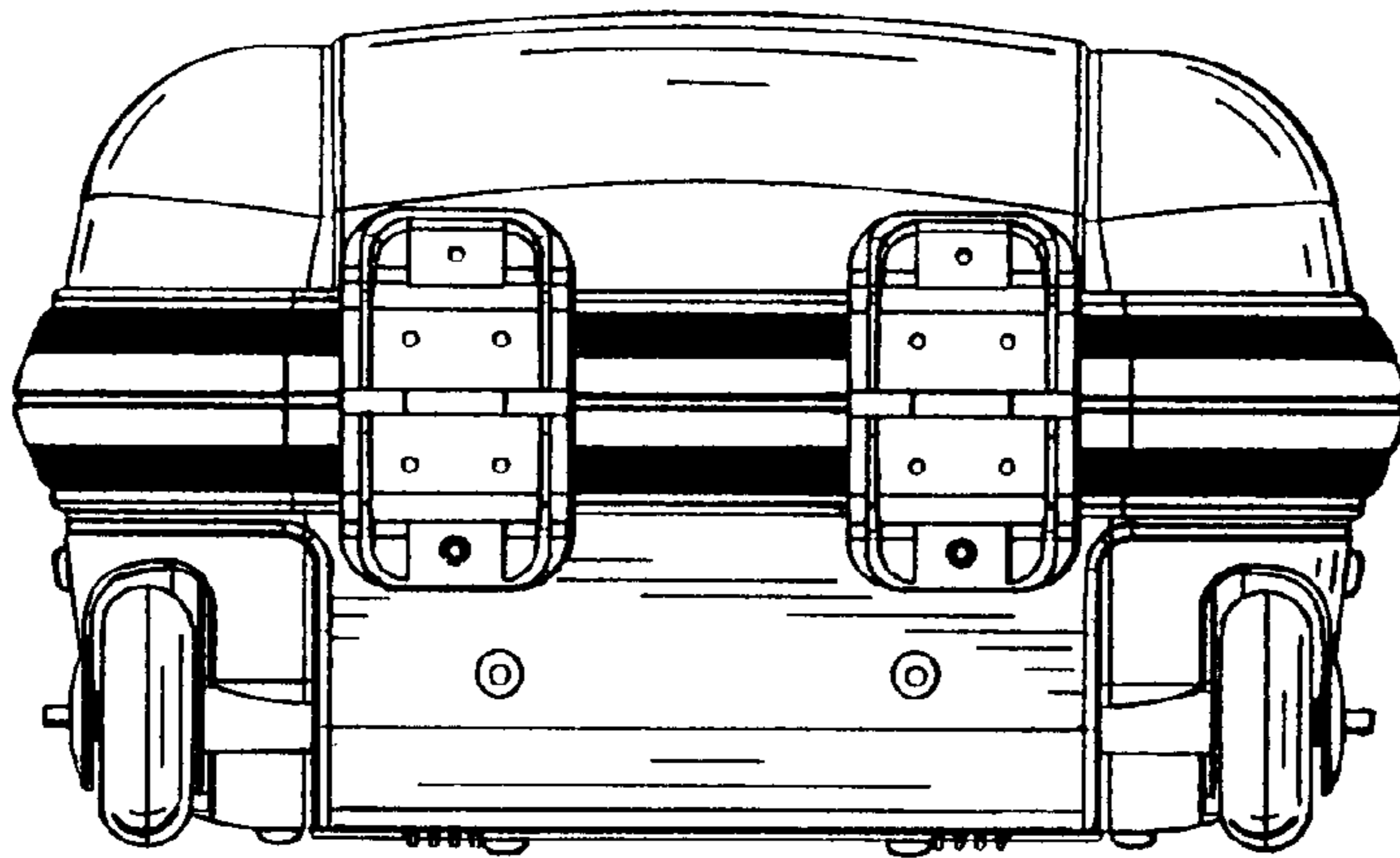

FIG. 7

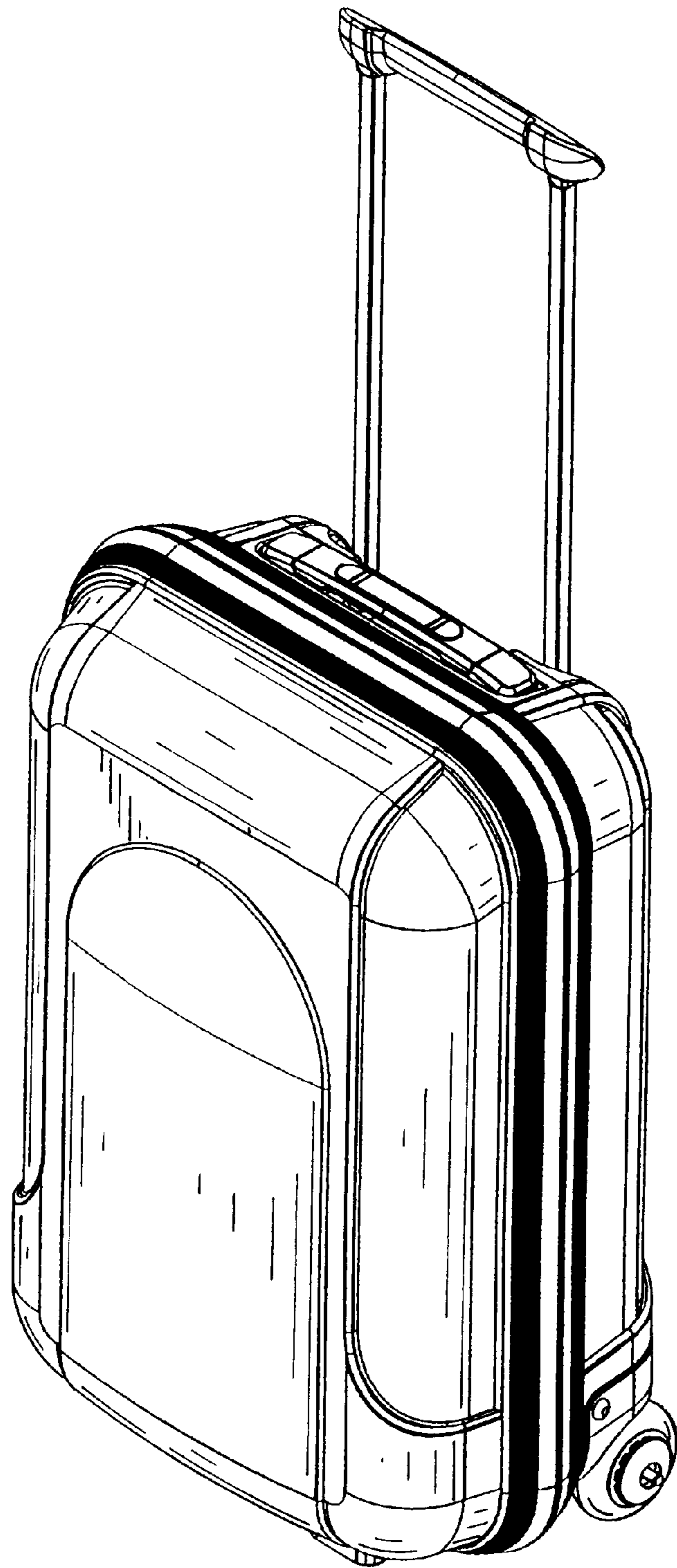

FIG. 8



UNITED STATES PATENT AND TRADEMARK OFFICE  
**CERTIFICATE OF CORRECTION**

PATENT NO. : Des. 428,698  
DATED : August 1, 2000  
INVENTOR(S) : Koon-Ming Cheng

Page 1 of 1

It is certified that error appears in the above-identified patent and that said Letters Patent is hereby corrected as shown below:

Page 1, change Assignee address from "Taipei, Japan" to -- Taipei City, Taiwan --.

Signed and Sealed this  
Seventeenth Day of July, 2001

*Attest:*

*Nicholas P. Godici*

*Attesting Officer*

NICHOLAS P. GODICI  
*Acting Director of the United States Patent and Trademark Office*