



US00D428672S

United States Patent [19]
Livingston-Capoano

[11] **Patent Number: Des. 428,672**
[45] **Date of Patent: ** Jul. 25, 2000**

[54] **MANICURE SUPPORT**

5,331,693 7/1994 Petersen et al. D23/277 X
5,890,694 4/1999 Possick 248/118 X

[76] Inventor: **Barbara Livingston-Capoano**, 381
Squankum-Yellow Brick Rd.,
Farmindale, N.J. 07727

Primary Examiner—Dominic Simone
Attorney, Agent, or Firm—Charles I. Brodsky

[**] Term: **14 Years**

[57] **CLAIM**

[21] Appl. No.: **29/114,762**

The ornamental design for a manicure support, as shown and described.

[22] Filed: **Dec. 1, 1999**

DESCRIPTION

[51] **LOC (7) Cl.** **28-03**

[52] **U.S. Cl.** **D28/56**

[58] **Field of Search** D28/56; 132/73;
248/118

FIG. 1 is a front perspective view of a manicure support, showing my new design;
FIG. 2 is a rear perspective view thereof;
FIG. 3 is a front elevational view thereof;
FIG. 4 is a rear elevational view thereof;
FIG. 5 is a left-side elevational view, and right-side elevational view being a mirror image;
FIG. 6 is a top plan view of the manicure support showing my new design; and,
FIG. 7 is a bottom plan view thereof.

[56] **References Cited**

U.S. PATENT DOCUMENTS

D. 309,356	7/1990	Johns	D28/56
968,965	8/1910	Macdonald	132/73
2,291,125	7/1942	Wilkinson	132/73
5,169,103	12/1992	Jimenez et al.	248/118
5,326,056	7/1994	Smith	248/118

1 Claim, 5 Drawing Sheets

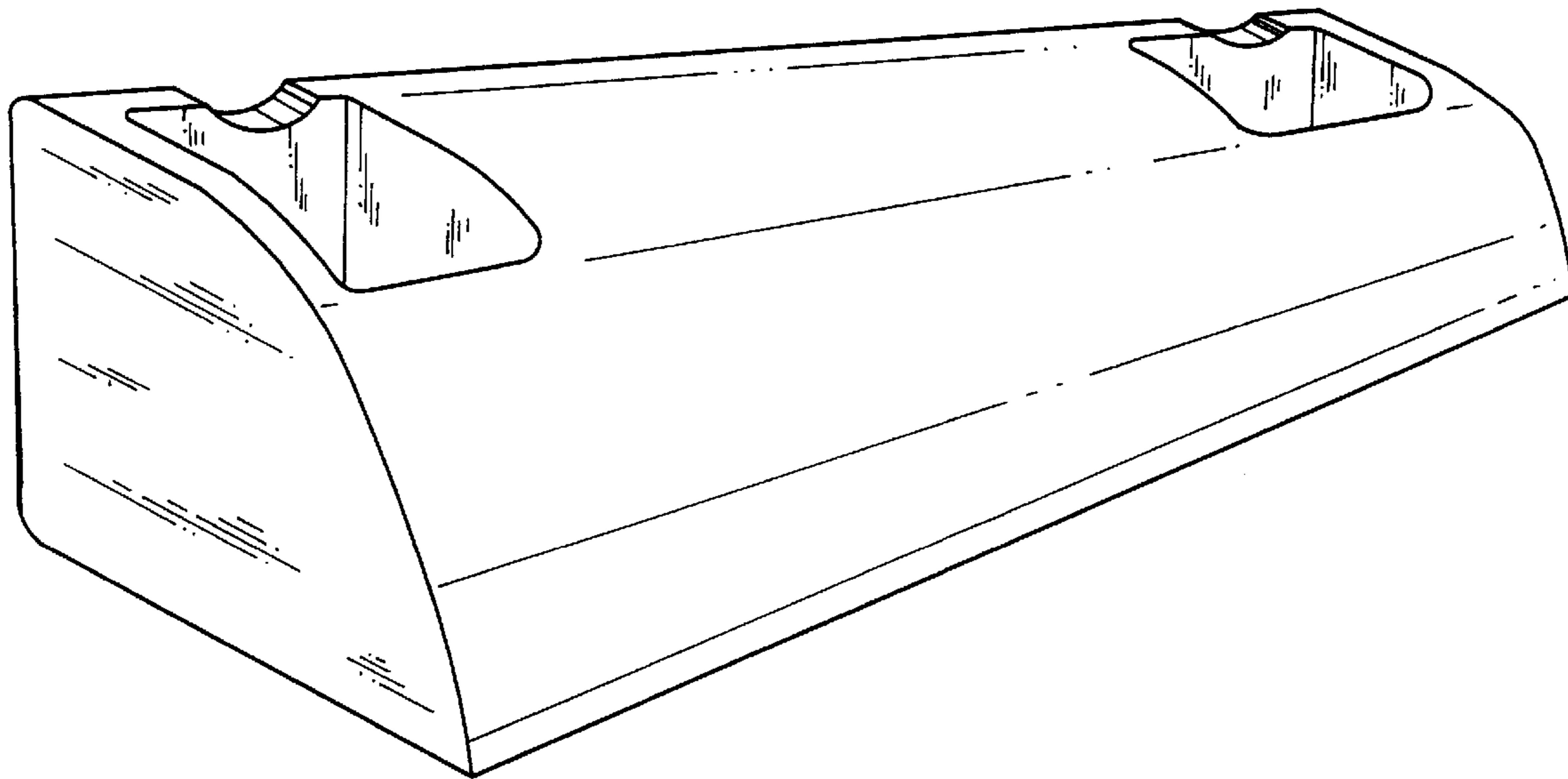

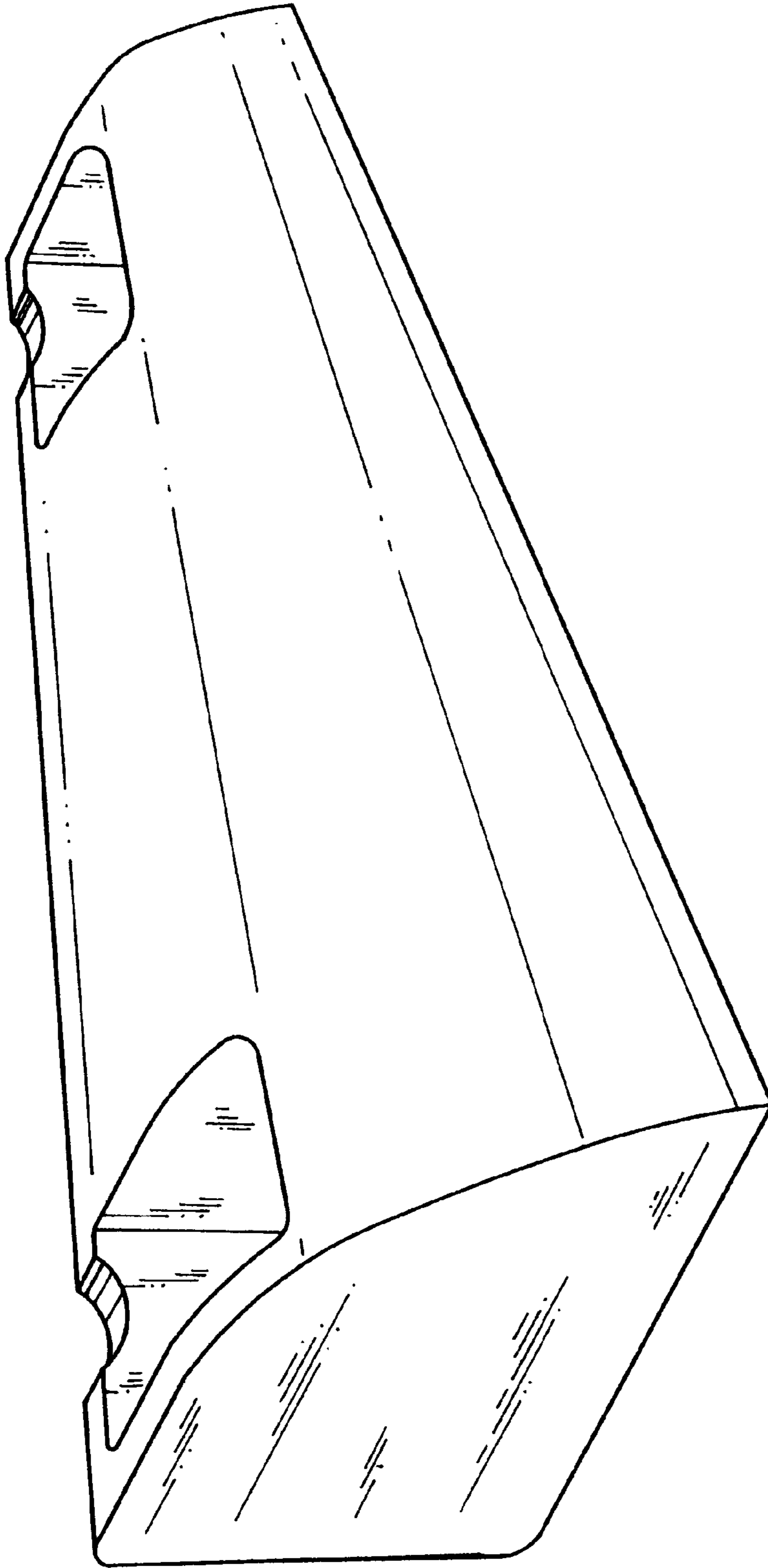

FIG. 1

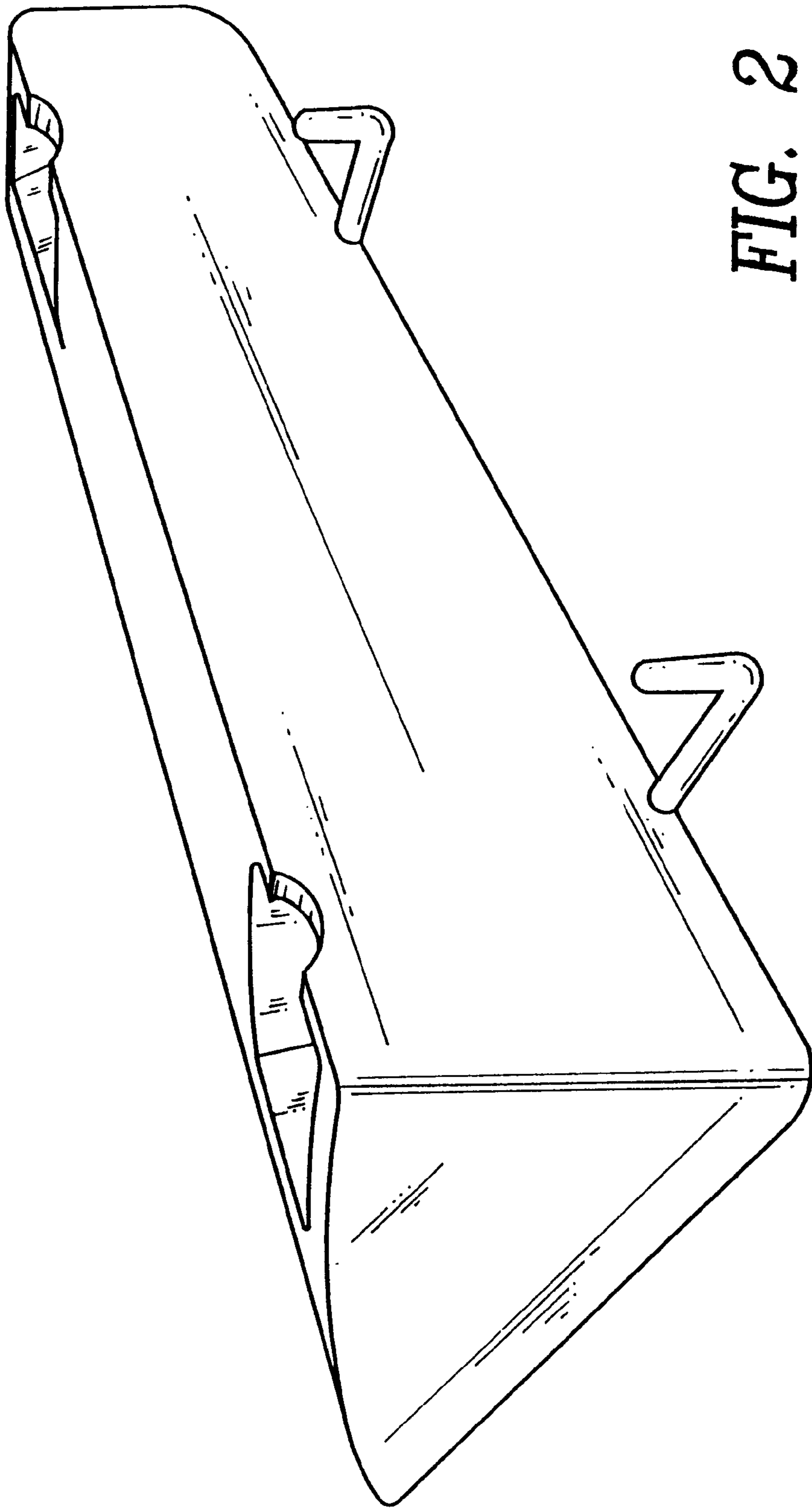

FIG. 2

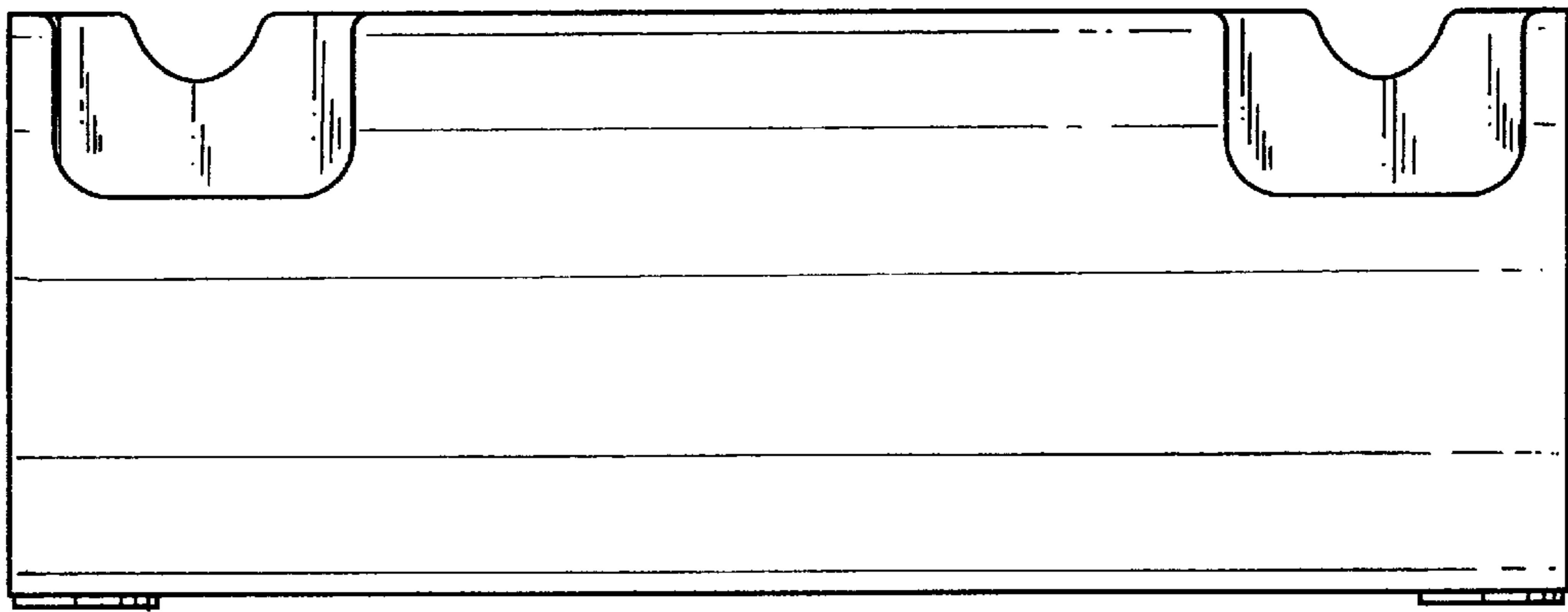

FIG. 3

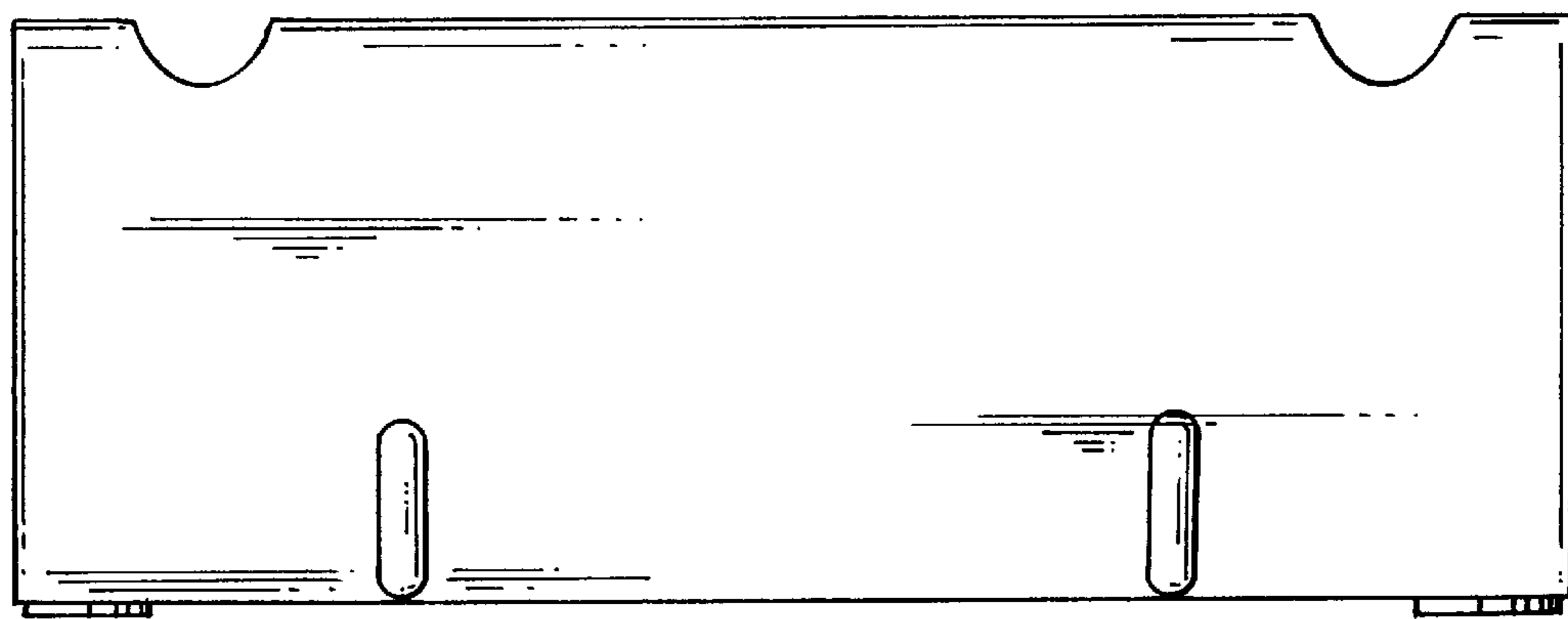

FIG. 4

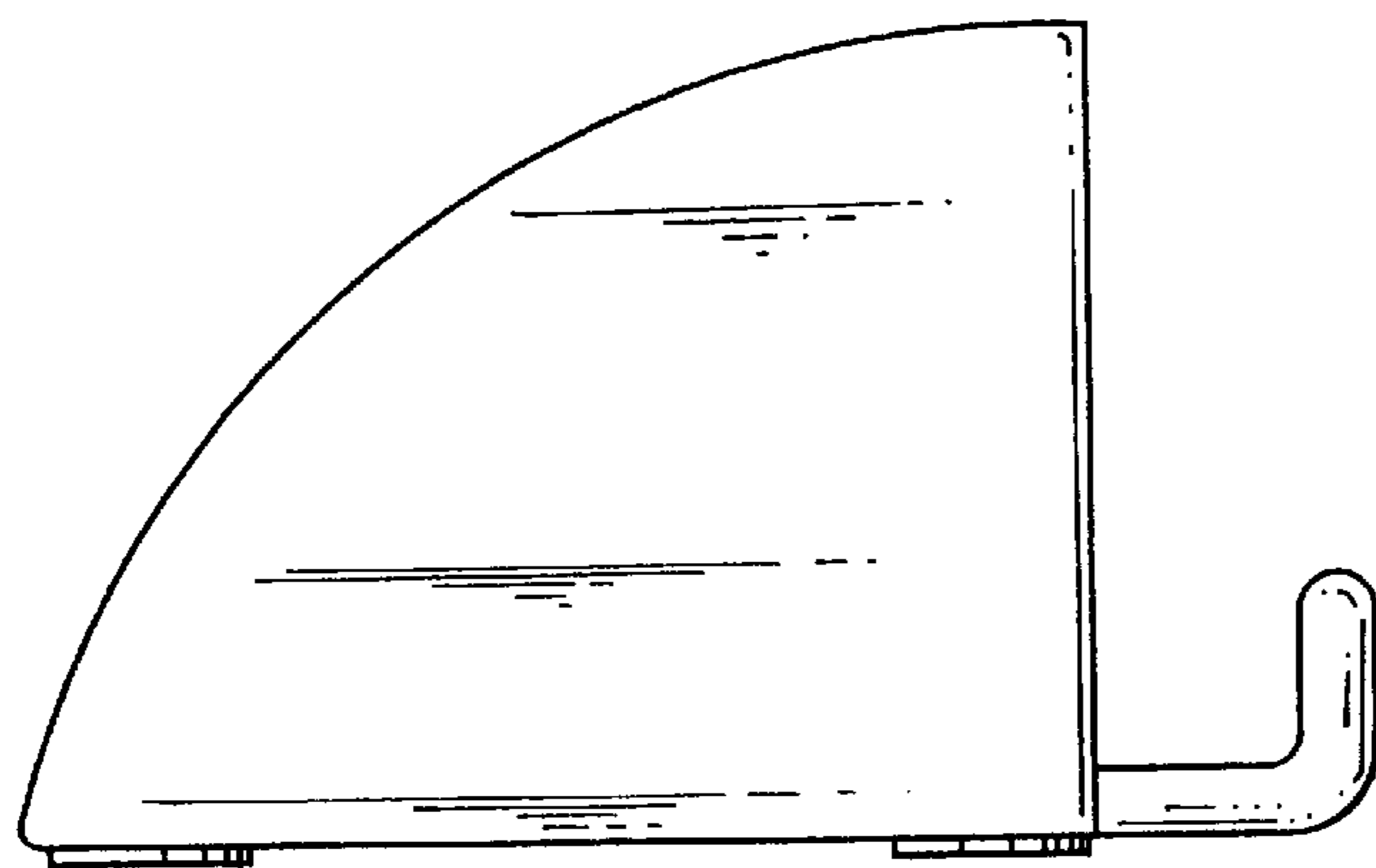

FIG. 5

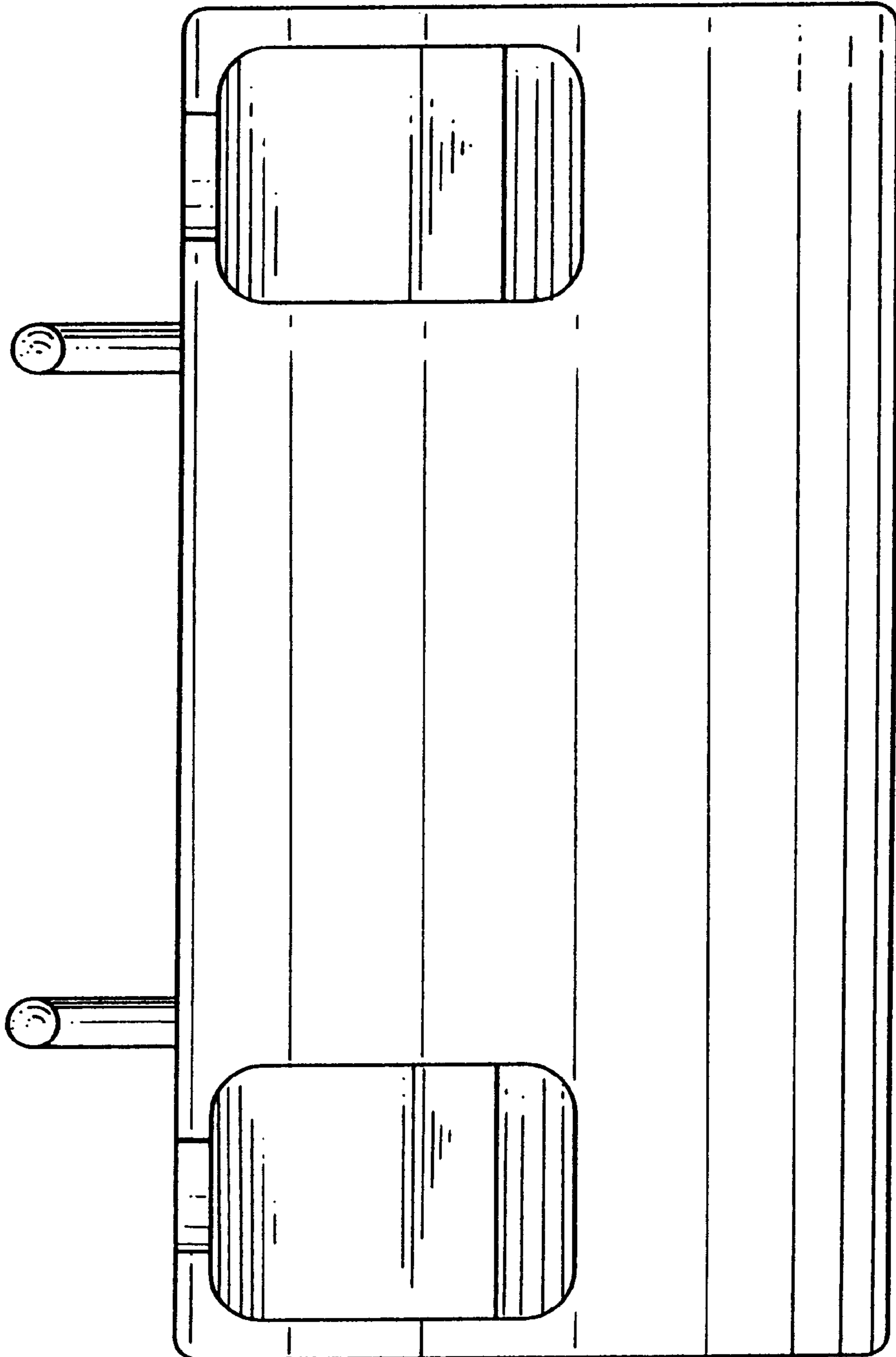

FIG. 6

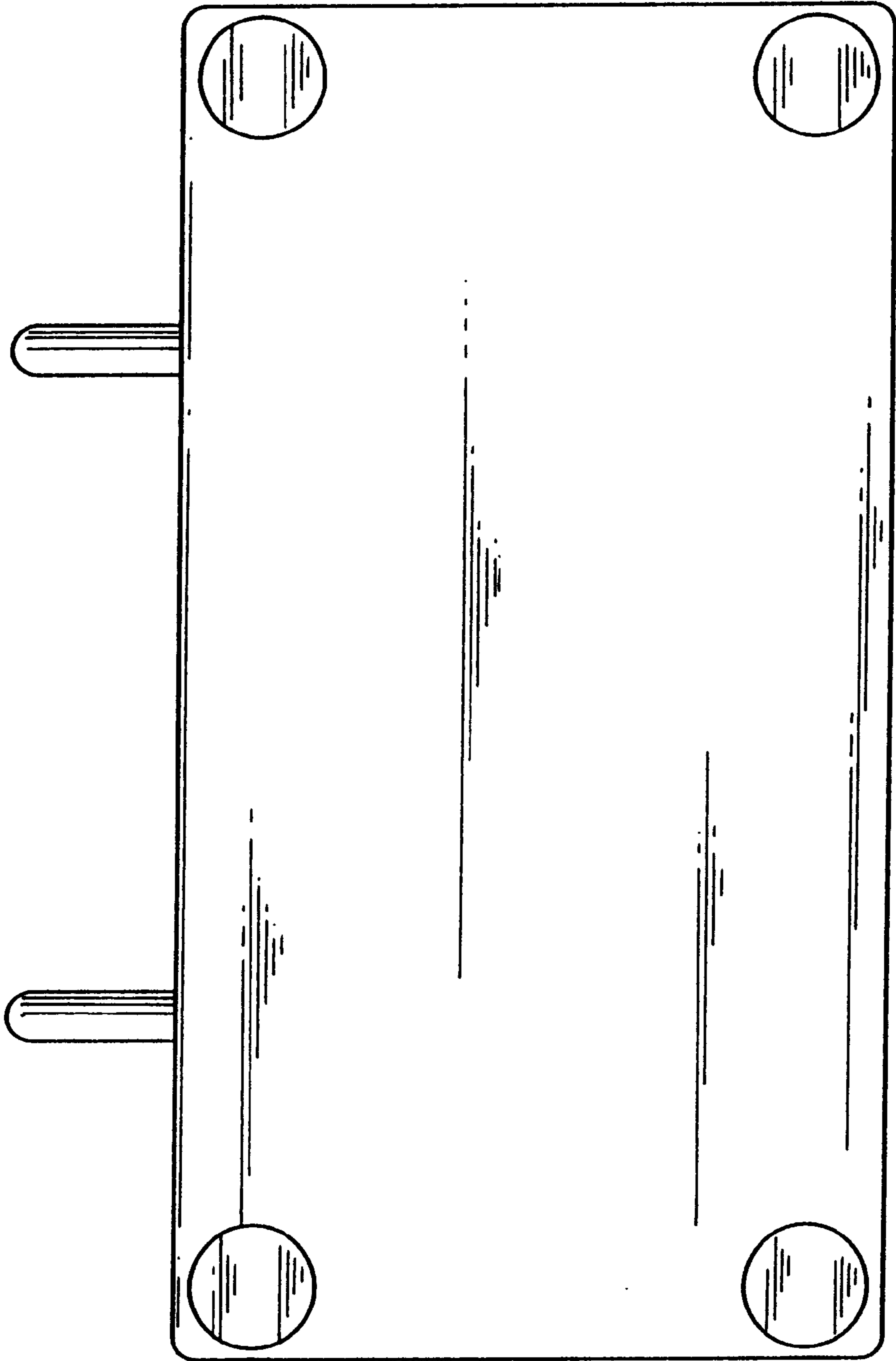

FIG. 7