



US00D428654S

United States Patent [19]

Schlesinger et al.

[11] Patent Number: Des. 428,654

[45] Date of Patent: ** Jul. 25, 2000

[54] METER FOR ANALYSIS OF BLOOD CONSTITUENTS

[75] Inventors: David M. Schlesinger, Morris Plains; Michael P. Zambelli, Livingston, both of N.J.; David J. Mayer, New York, N.Y.; Steven Bellofatto, Closter; Mario A. Turchi, Leonia, both of N.J.

[73] Assignee: Becton, Dickinson and Company, Franklin Lakes, N.J.

[**] Term: 14 Years

[21] Appl. No.: 29/103,999

[22] Filed: Apr. 26, 1999

[51] LOC (7) Cl. 24-01

[52] U.S. Cl. D24/169

[58] Field of Search D24/169, 167, D24/165; 600/316, 319, 322, 368, 345, 347, 583; 422/56, 61, 68.1

[56] References Cited

U.S. PATENT DOCUMENTS

- D. 369,216 4/1996 Micinski et al. D24/169
- D. 371,605 7/1996 Wong et al. D24/169
- D. 393,313 4/1998 Meisner et al. D24/169

- D. 399,566 10/1998 Sohrab et al. D24/169
- D. 406,895 3/1999 Byrd et al. D24/169
- D. 411,621 6/1999 Eisenbarth et al. D24/169
- 5,714,123 2/1998 Sohrab 422/99

Primary Examiner—Stella Reid
Attorney, Agent, or Firm—Alan W. Fiedler

[57] CLAIM

The ornamental design for a meter for analysis of blood constituents, as shown and described.

DESCRIPTION

FIG. 1 is a perspective view of a meter for analysis of blood constituents, showing our design;
 FIG. 2 is a front elevational view of the meter for analysis of blood constituents of FIG. 1;
 FIG. 3 is a back elevational view of the meter for analysis of blood constituents of FIG. 1;
 FIG. 4 is a top plan view of the meter for analysis of blood constituents of FIG. 1;
 FIG. 5 is a right side elevational view of the meter for analysis of blood constituents of FIG. 1;
 FIG. 6 is a left side elevational view of the meter for analysis of blood constituents of FIG. 1; and,
 FIG. 7 is a bottom plan view of the meter for analysis of blood constituents of FIG. 1.

1 Claim, 4 Drawing Sheets

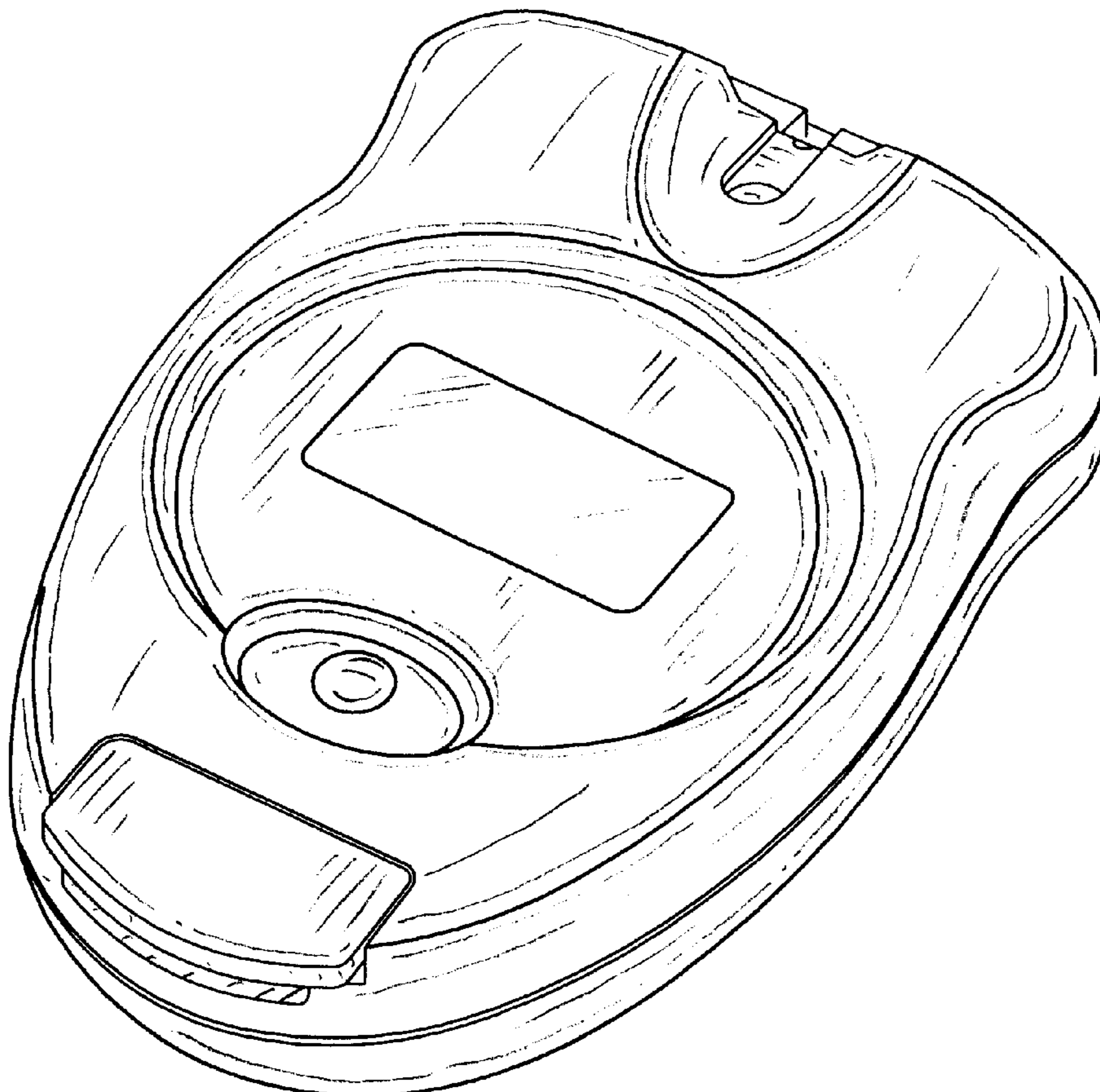

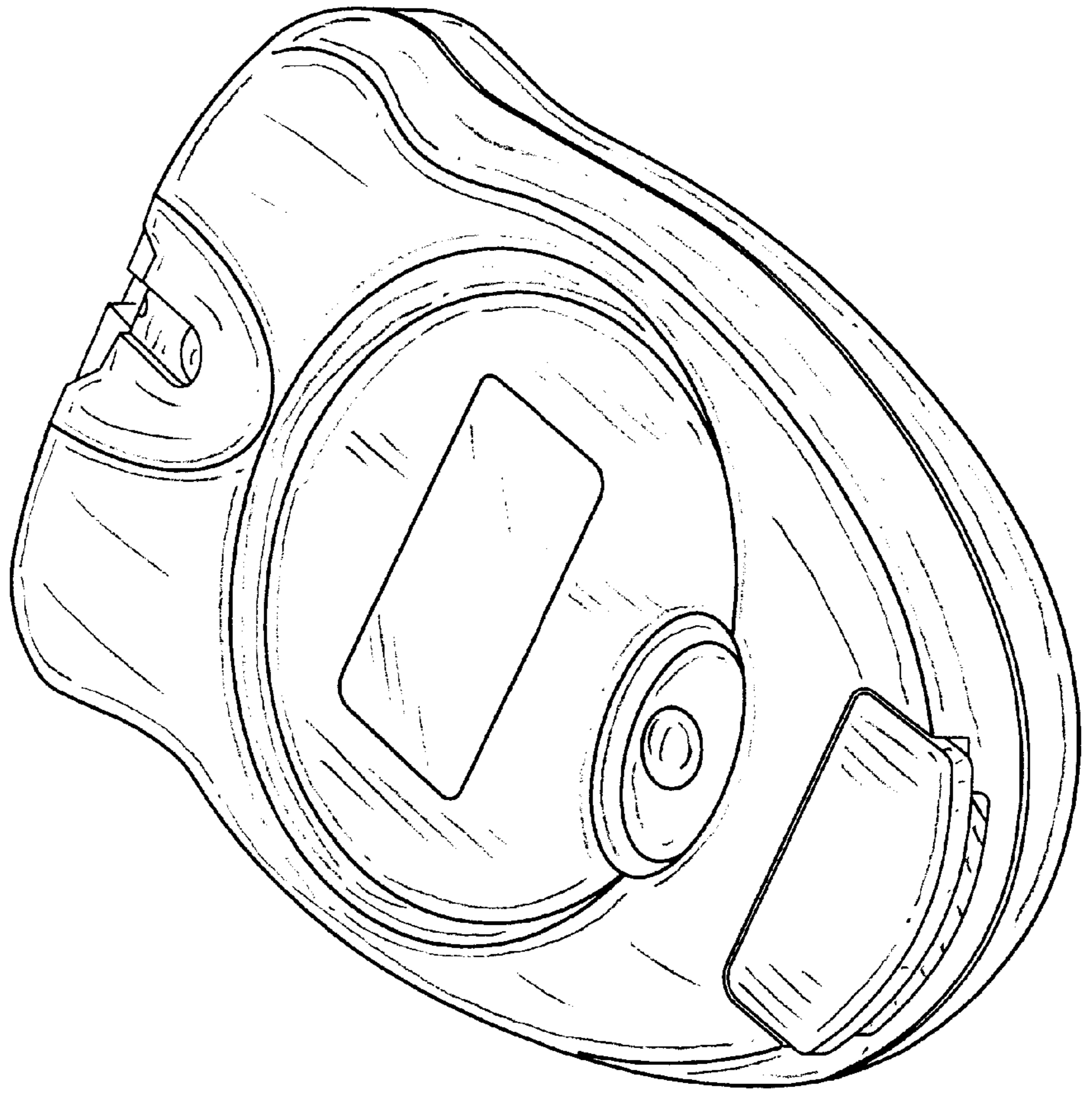

FIG-1

FIG-2

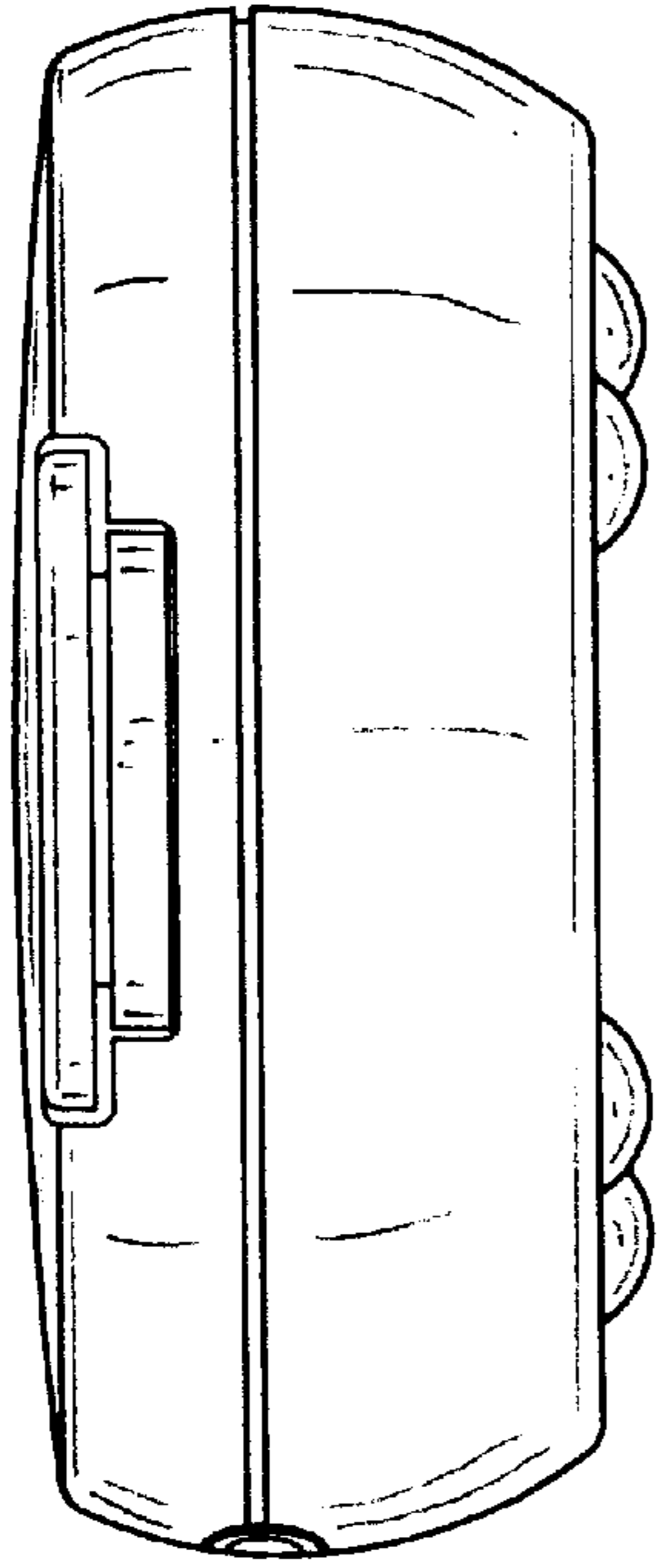

FIG-3

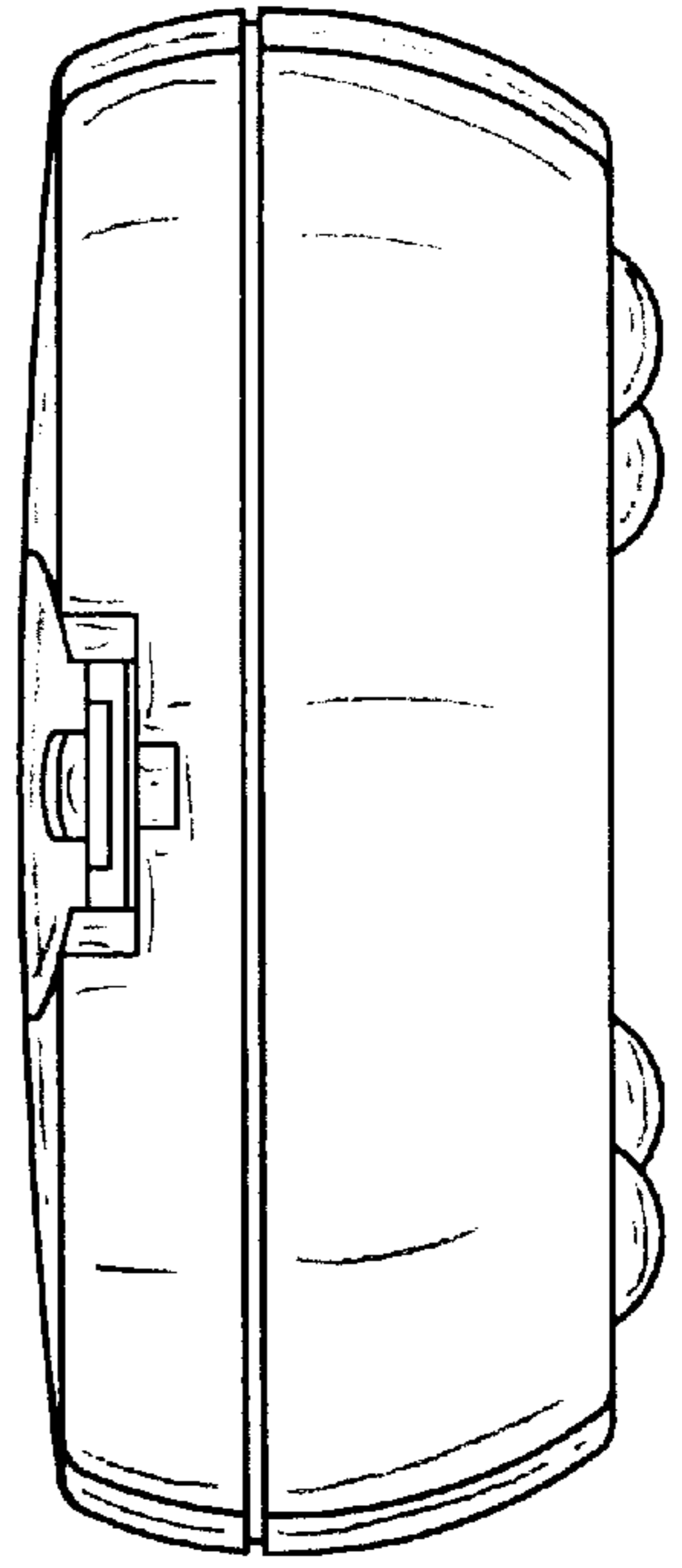

FIG-5

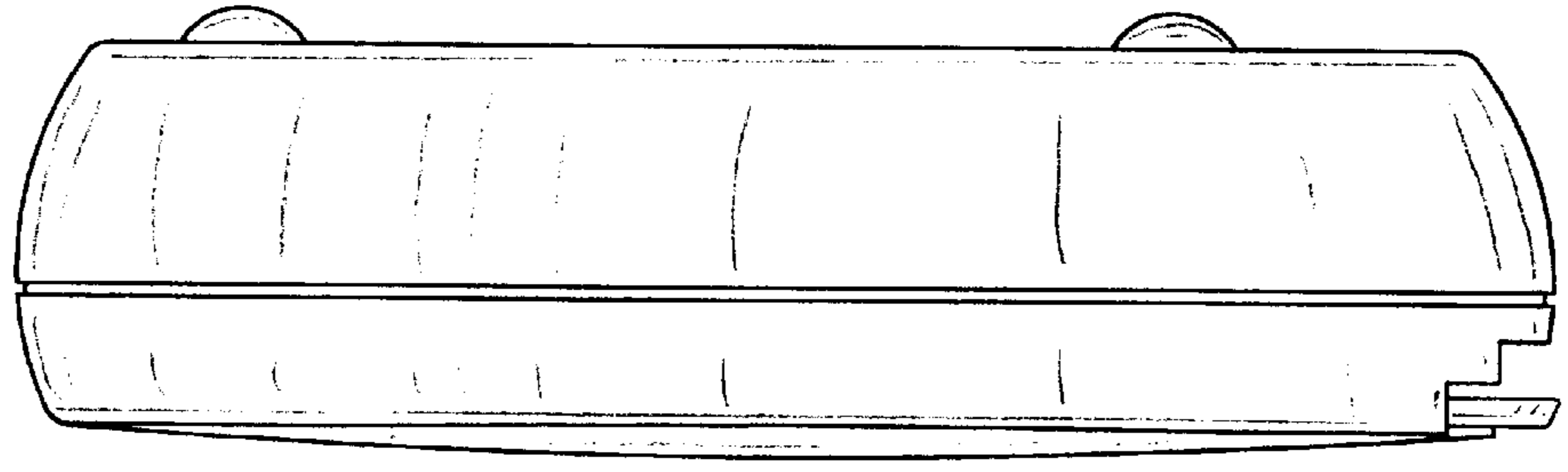

FIG-4

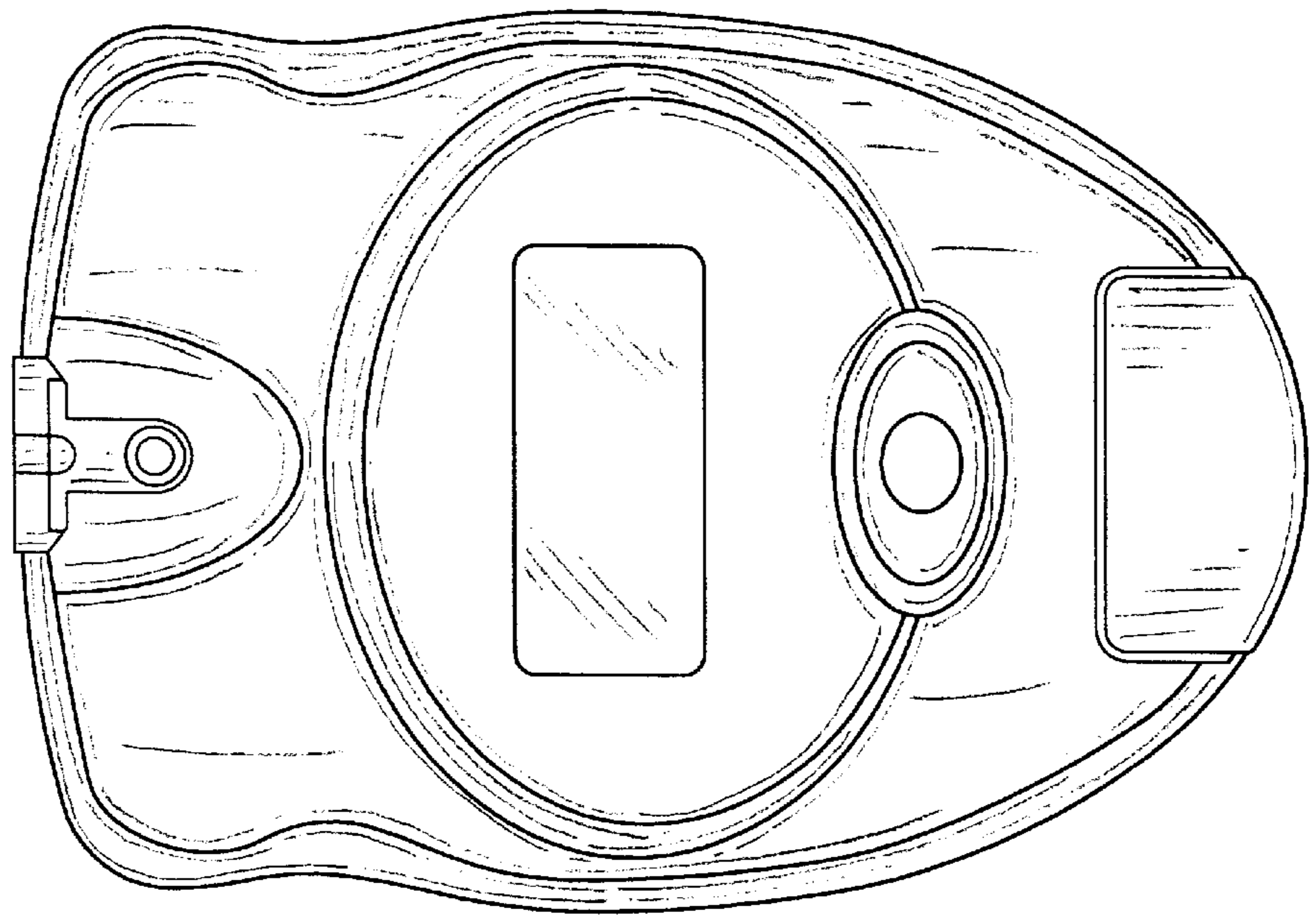

FIG-7

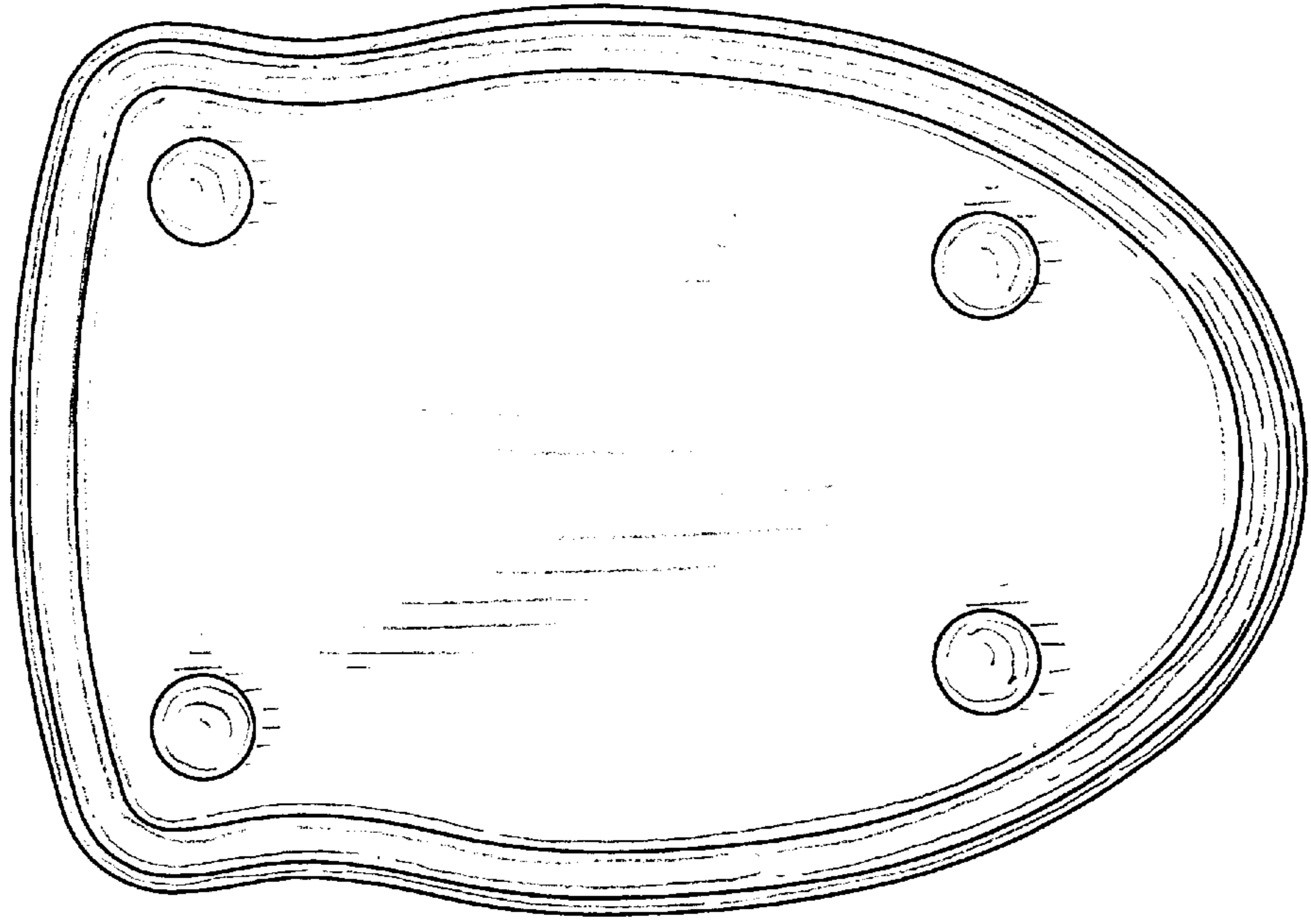

FIG-6

