



US00D428634S

United States Patent [19]

[11] **Patent Number: Des. 428,634**

Nagai et al.

[45] **Date of Patent: ** Jul. 25, 2000**

[54] **RECESSED BACK PORTION OF A GOLF CLUB HEAD**

Primary Examiner—Mitchell Siegel
Attorney, Agent, or Firm—Gerald R. Boss, Esq.; Troutman Sanders LLP

[75] Inventors: **Masao Nagai**, Dunwoody; **David Llewellyn**, Norcross, both of Ga.; **Toshi Nagasaki**, Osaka, Japan

[57] **CLAIM**

The ornamental design for a recessed back portion of a golf club head, as shown and described.

[73] Assignee: **Mizuno Corporation**, Osaka, Japan

DESCRIPTION

[**] Term: **14 Years**

[21] Appl. No.: **29/108,618**

FIG. 1 is a perspective view of a recessed back portion of a golf club head showing my new design;
FIG. 2 is an elevational view thereof;
FIG. 3 is a top plan view thereof;
FIG. 4 is a cross-sectional view taken along lines 4—4 in FIG. 2;
FIG. 5 is a cross-sectional view taken along lines 5—5 in FIG. 2;
FIG. 6 is a cross-sectional view taken along lines 6—6 in FIG. 2; and,
FIG. 7 is a cross-sectional view taken along lines 7—7 in FIG. 2.

[22] Filed: **Jul. 30, 1999**

[51] **LOC (7) Cl.** **21-02**

[52] **U.S. Cl.** **D21/759**

[58] **Field of Search** D21/747-751,
D21/753, 759; 473/324, 350

[56] **References Cited**

U.S. PATENT DOCUMENTS

D. 377,381	1/1997	Takahashi	D21/748
D. 379,485	5/1997	Ragano	D21/749
D. 383,819	9/1997	Takahashi et al.	D21/749
D. 383,820	9/1997	Watanabe	D21/749
D. 386,549	11/1997	Takahashi et al.	D21/748

The broken line showing of a golf club head is for illustrative purposes only and forms no part of the claimed design.

1 Claim, 2 Drawing Sheets

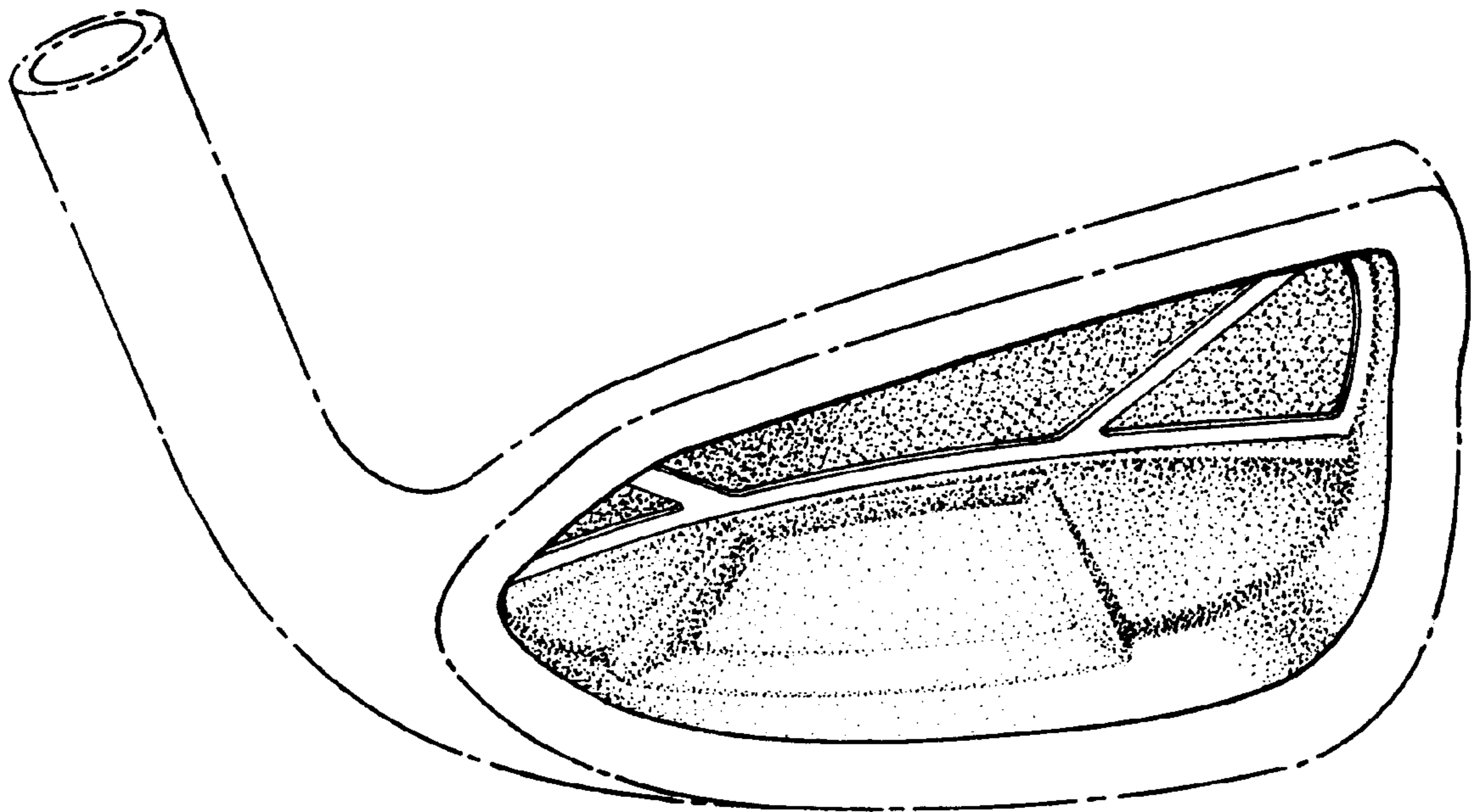

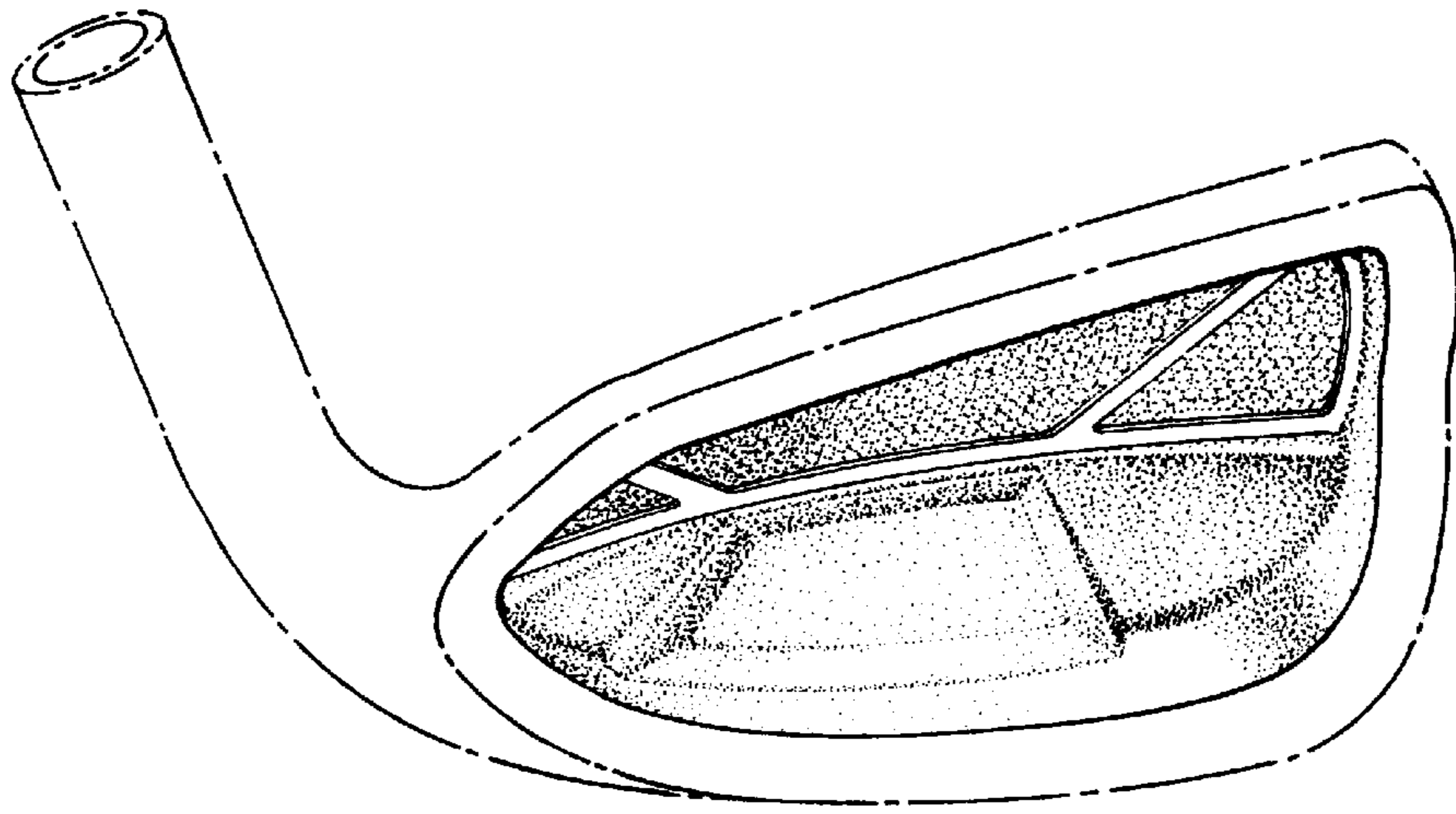

FIG 1

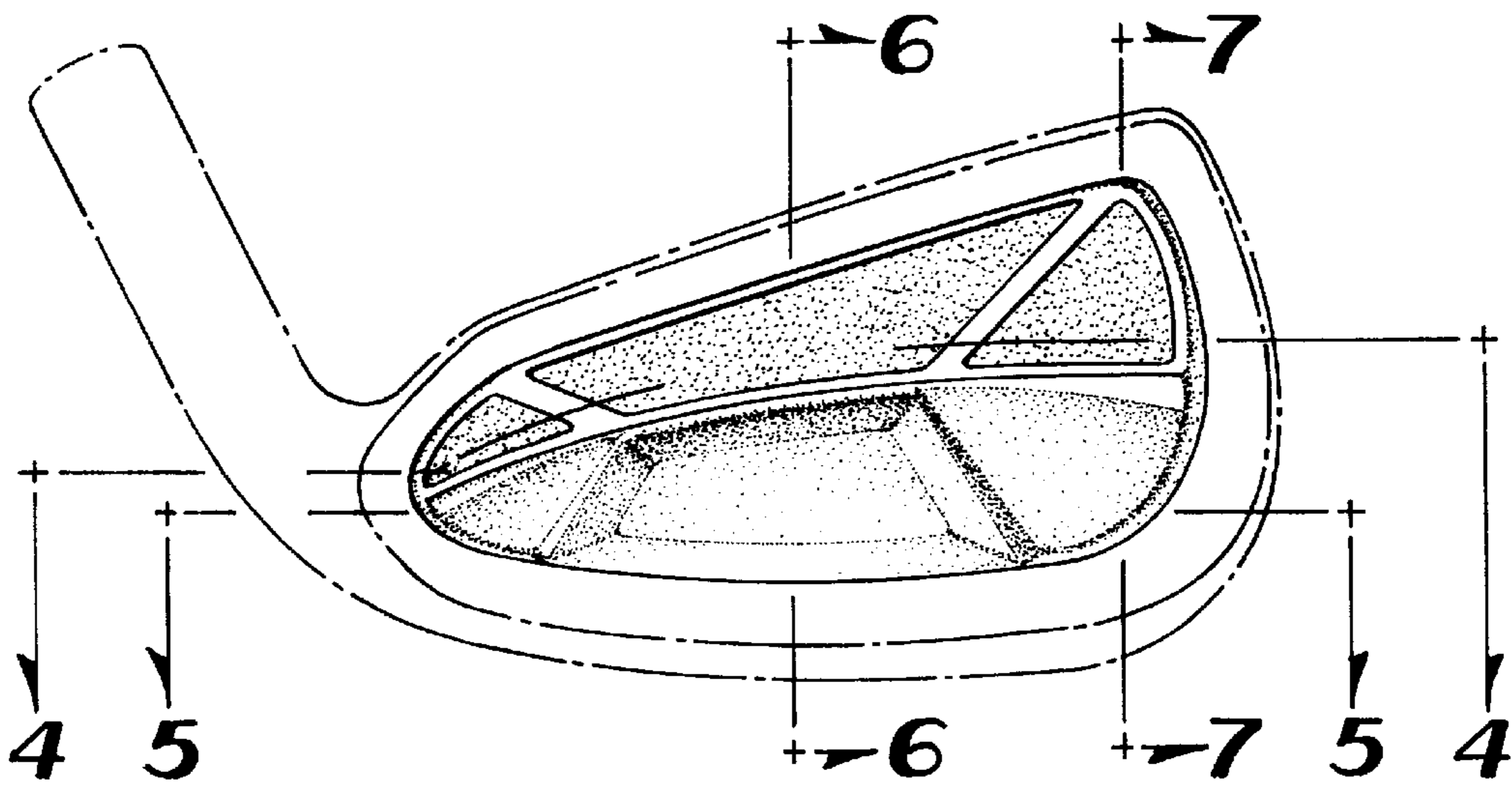

FIG 2

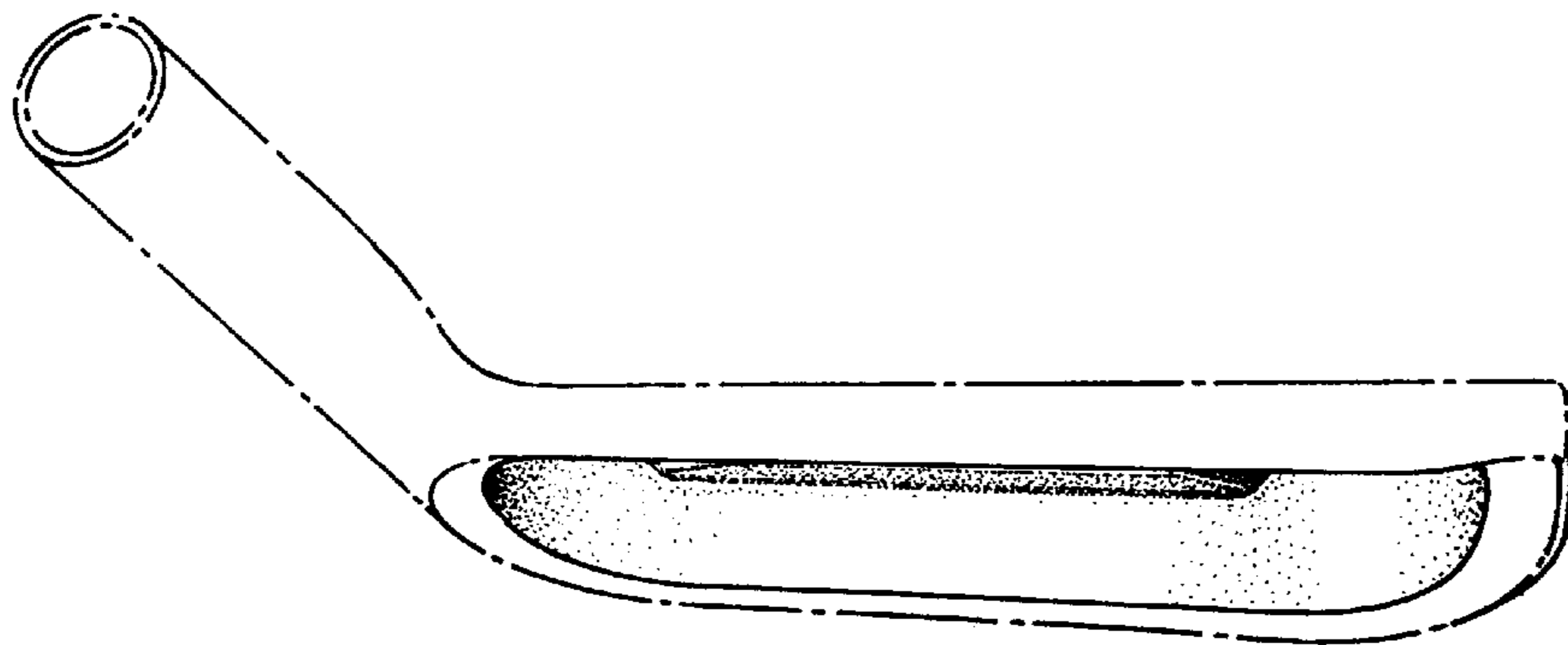

FIG 3

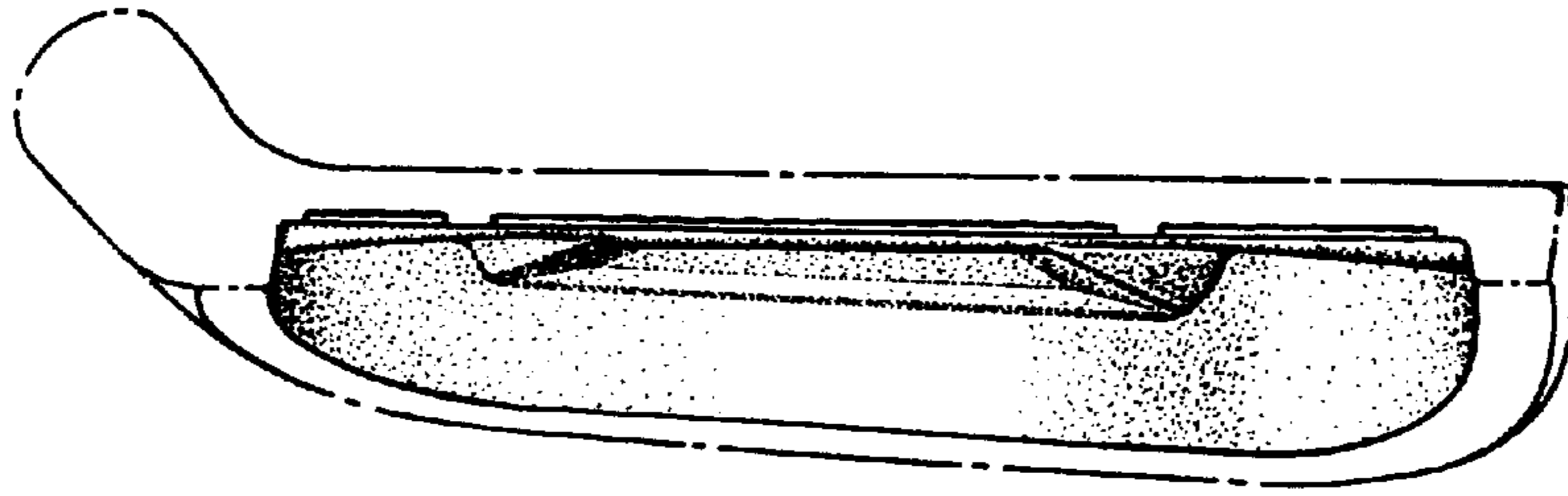

FIG 4



FIG 5

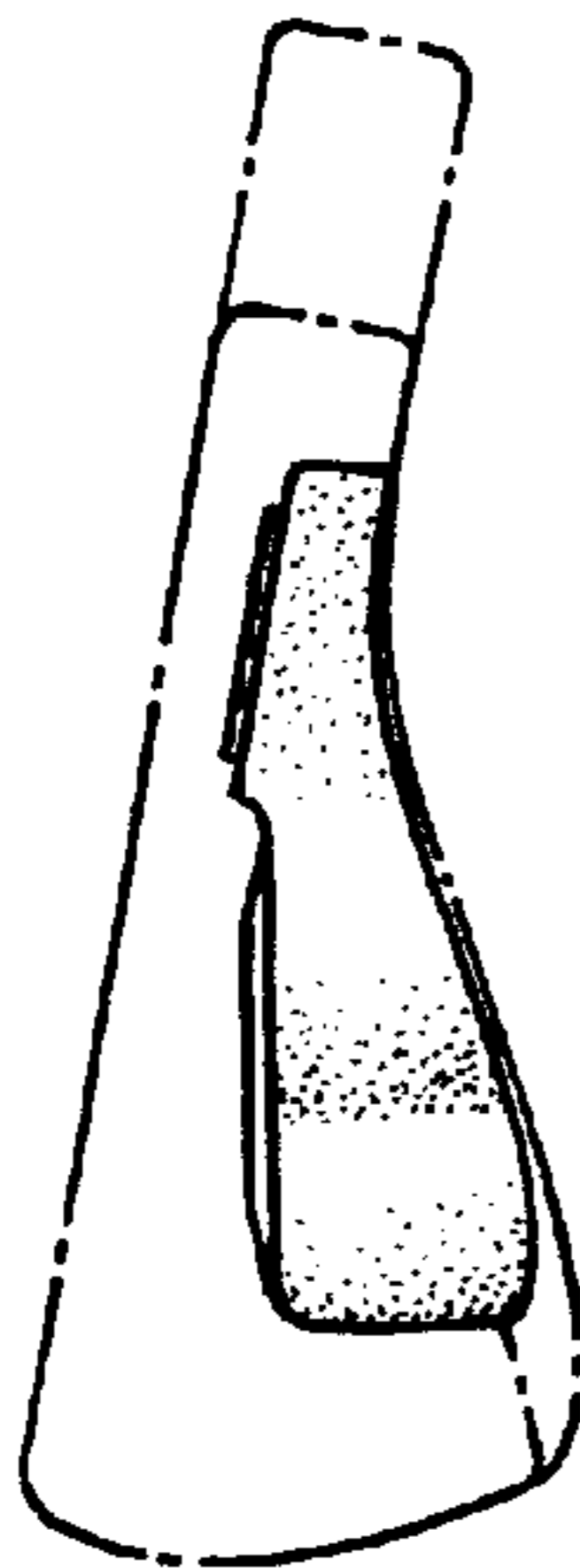

FIG 6

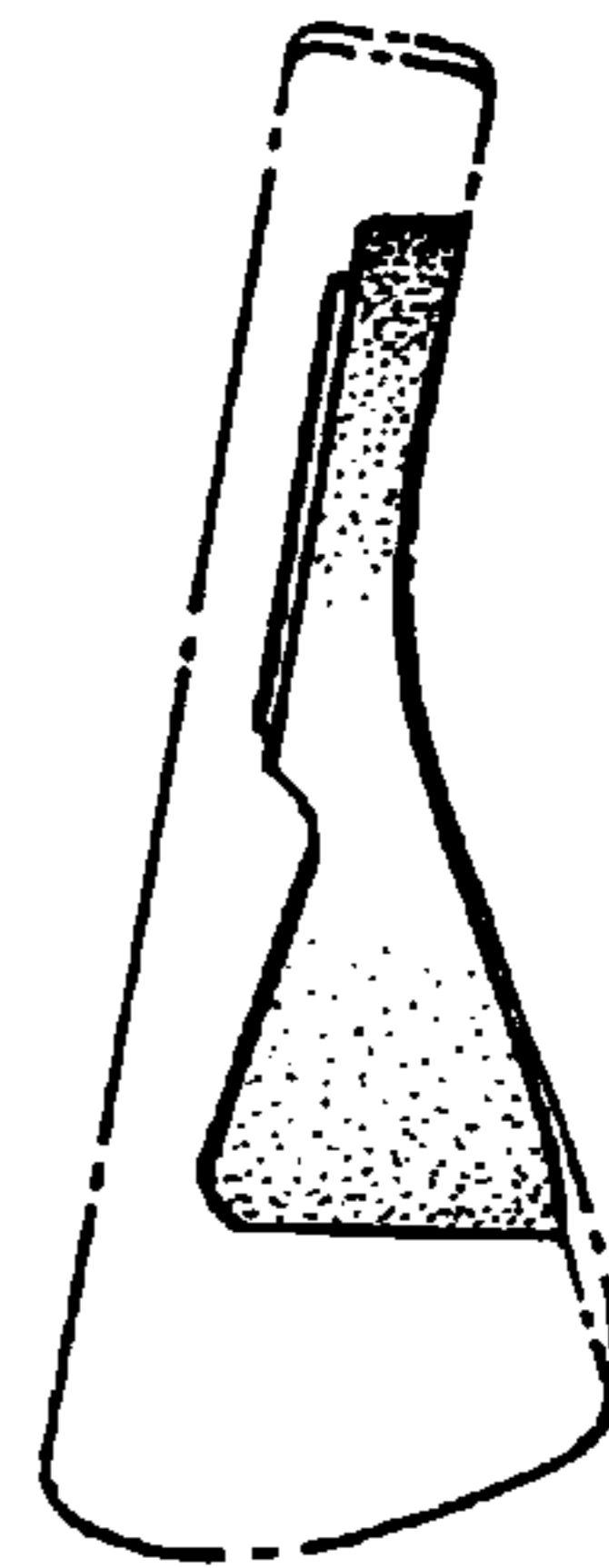

FIG 7