



US00D428633S

United States Patent [19] Hasebe'

[11] Patent Number: Des. 428,633

[45] Date of Patent: ** Jul. 25, 2000

[54] GOLF CLUB HEAD

5,658,209 8/1997 Blakemore 473/350

[75] Inventor: Yu Hasebe', Tokyo, Japan

Primary Examiner—Mitchell Siegel
Attorney, Agent, or Firm—Sughrue, Mion, Zinn, Macpeak & Seas, PLLC

[73] Assignee: Bridgestone Sports Co., Ltd., Tokyo, Japan

[**] Term: 14 Years

[57] CLAIM

[21] Appl. No.: 29/114,159

The ornamental design for the golf club head, as shown in the drawings.

[22] Filed: Nov. 19, 1999

DESCRIPTION

[51] LOC (7) Cl. 21-02

[52] U.S. Cl. D21/748

[58] Field of Search D21/747-751;
473/324, 329-331, 350

FIG. 1 is a perspective view of a golf club head, as viewed from a left, rear and under position, view showing the subject design;

FIG. 2 is a front view of a golf club head, view showing the subject design;

FIG. 3 is a rear view of the golf club head;

FIG. 4 is a left side view the golf club head;

FIG. 5 is a right side view of the golf club head;

FIG. 6 is a top plan view of the golf club head;

FIG. 7 is a bottom plan view of the golf club head; and,

FIG. 8 is a sectional view of the golf club head taken along a line 8—8 in FIG. 3.

[56] References Cited

U.S. PATENT DOCUMENTS

D. 228,355	9/1973	Penna	D21/749
D. 282,820	3/1986	Watanabe	D21/220
D. 381,385	7/1997	Shinohara et al.	D21/220
D. 412,545	8/1999	Best et al.	D21/759
D. 417,248	11/1999	Matsuo	D21/748

1 Claim, 2 Drawing Sheets

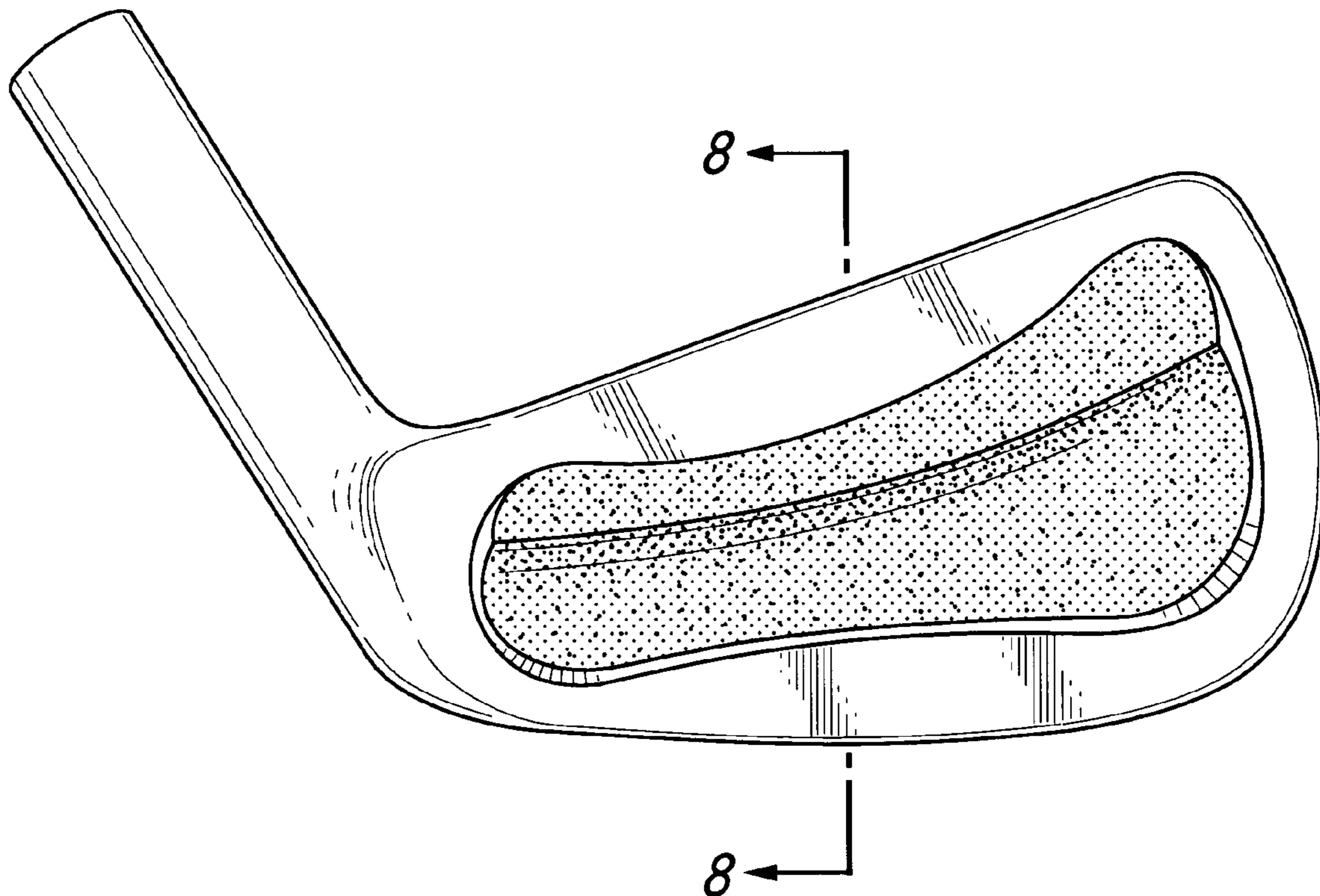

FIG. 1

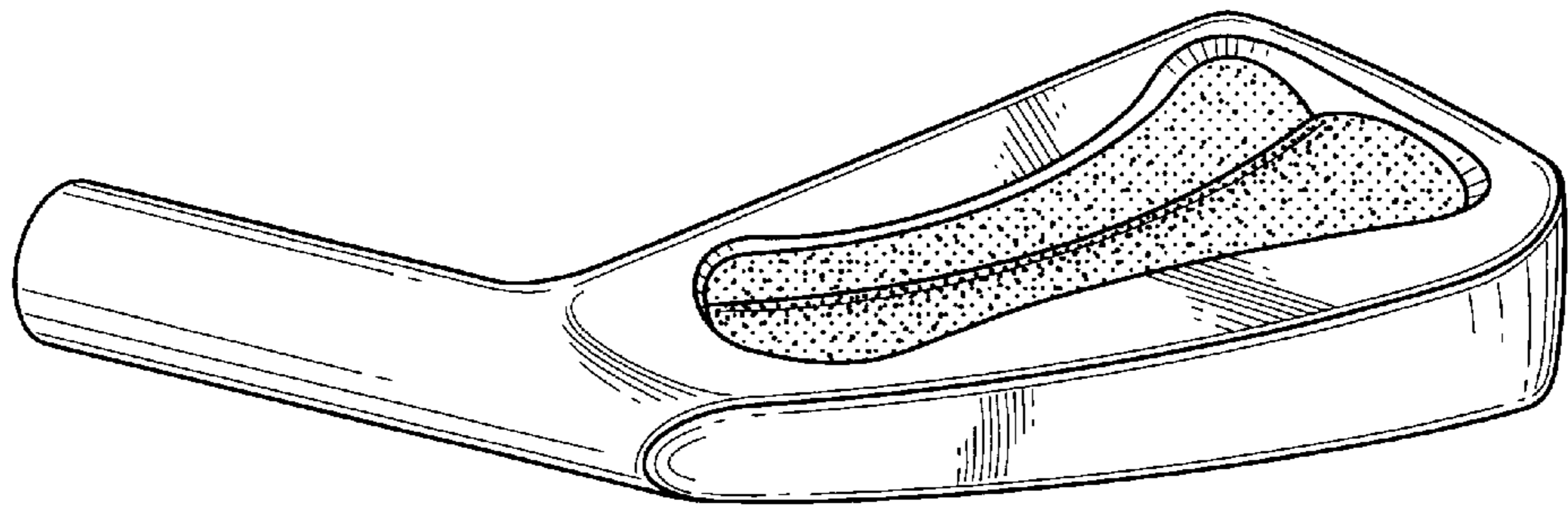

FIG. 2

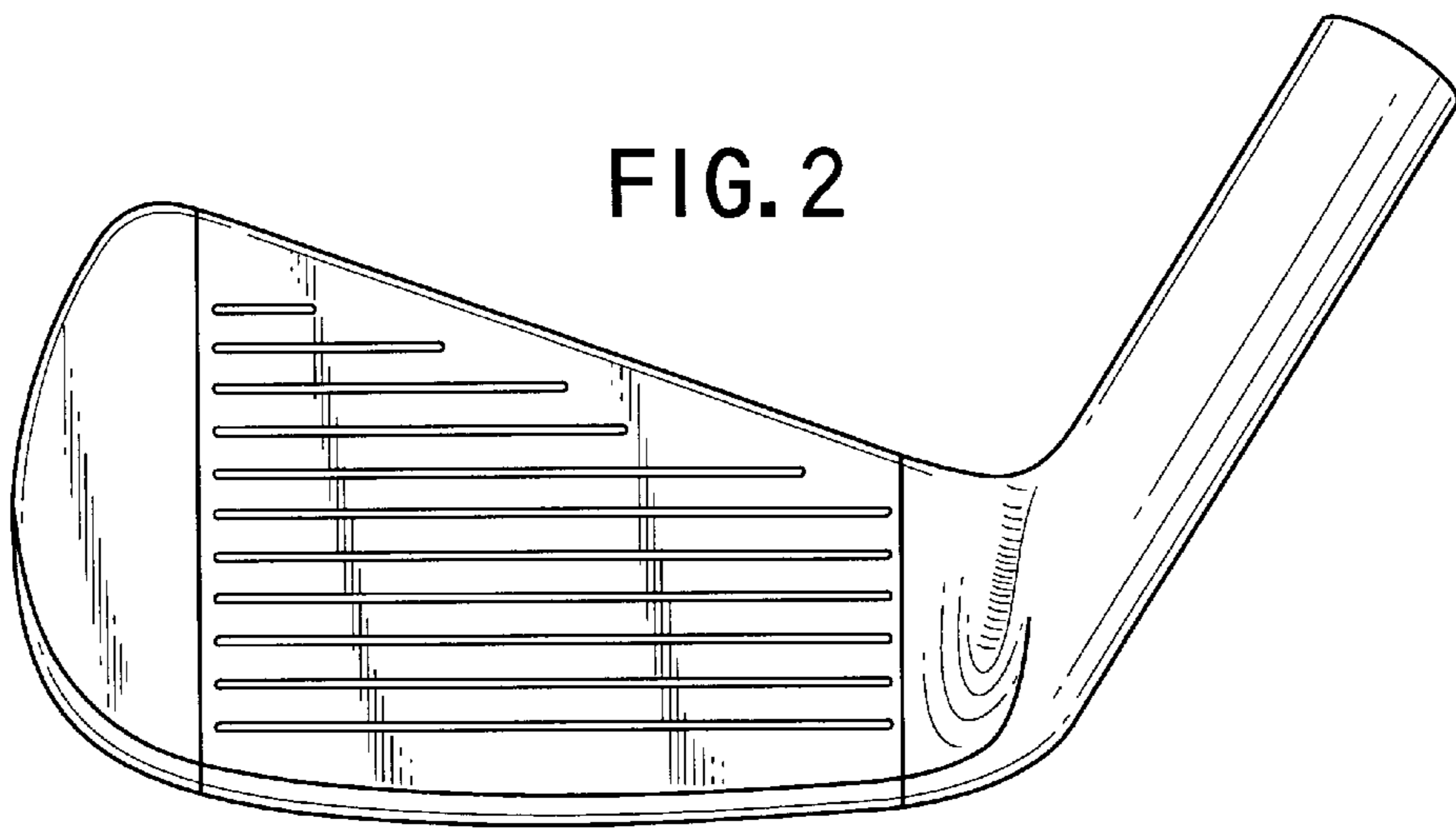

FIG. 3

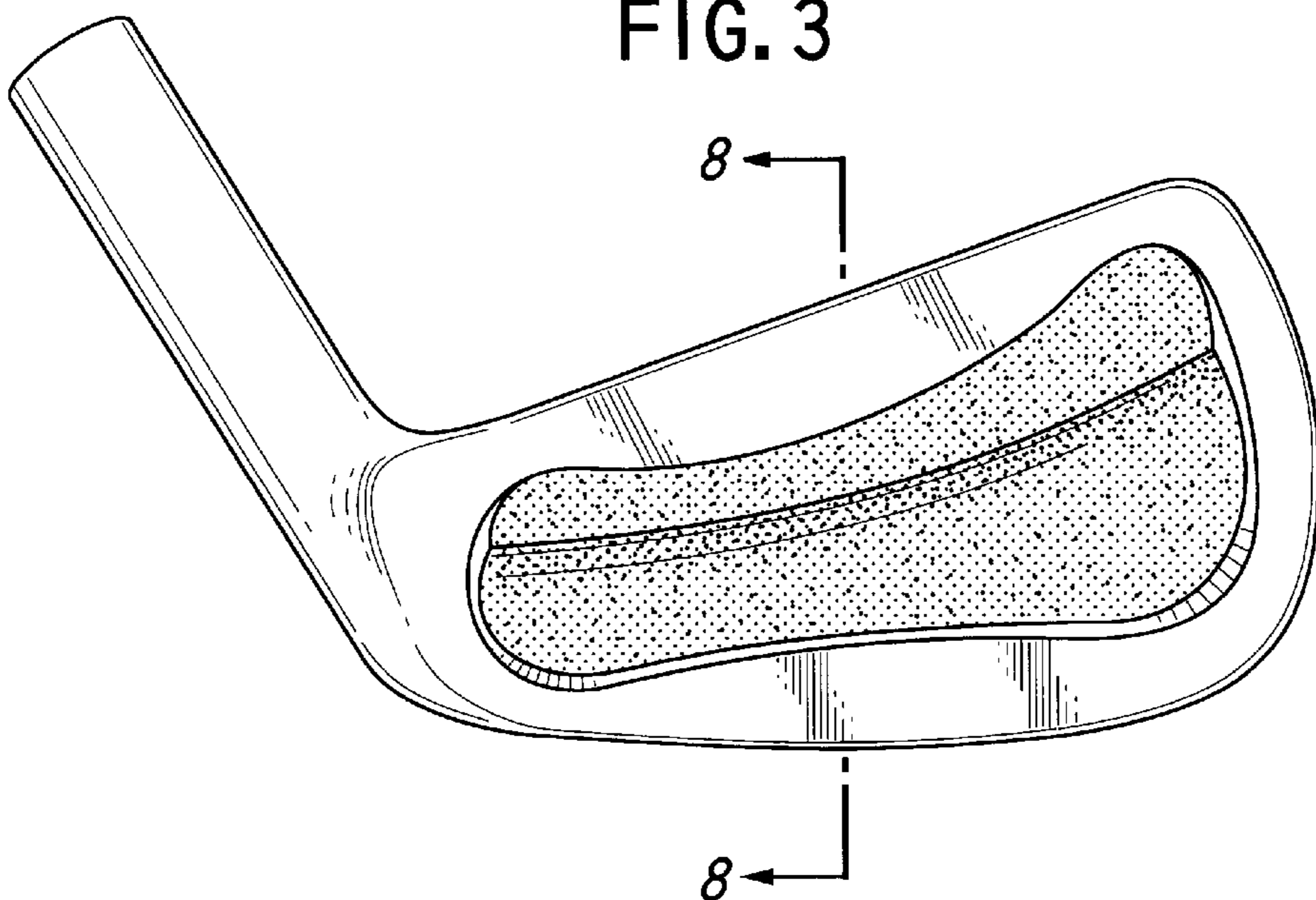

FIG. 4

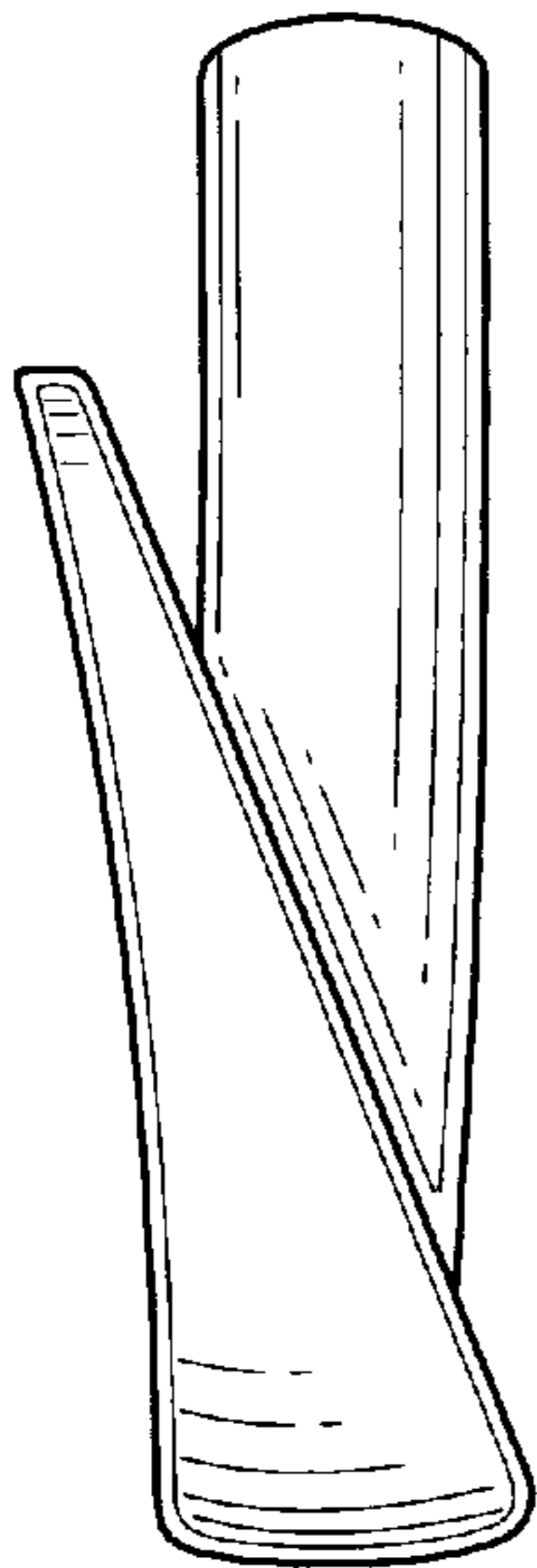

FIG. 5

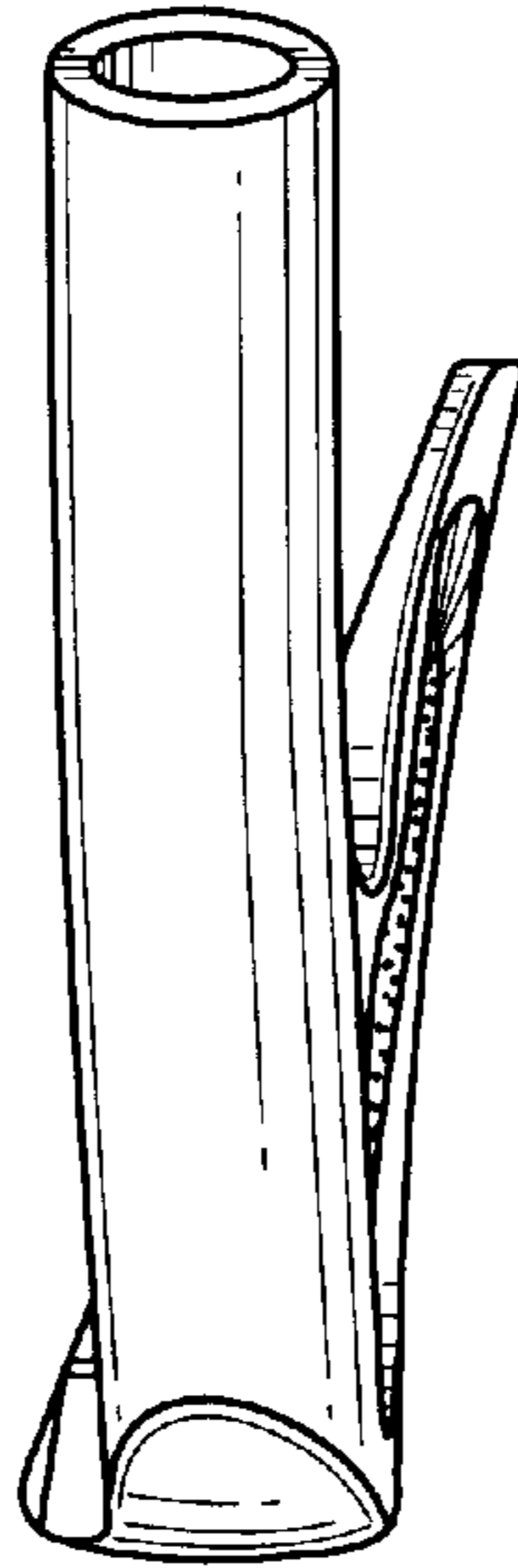

FIG. 8

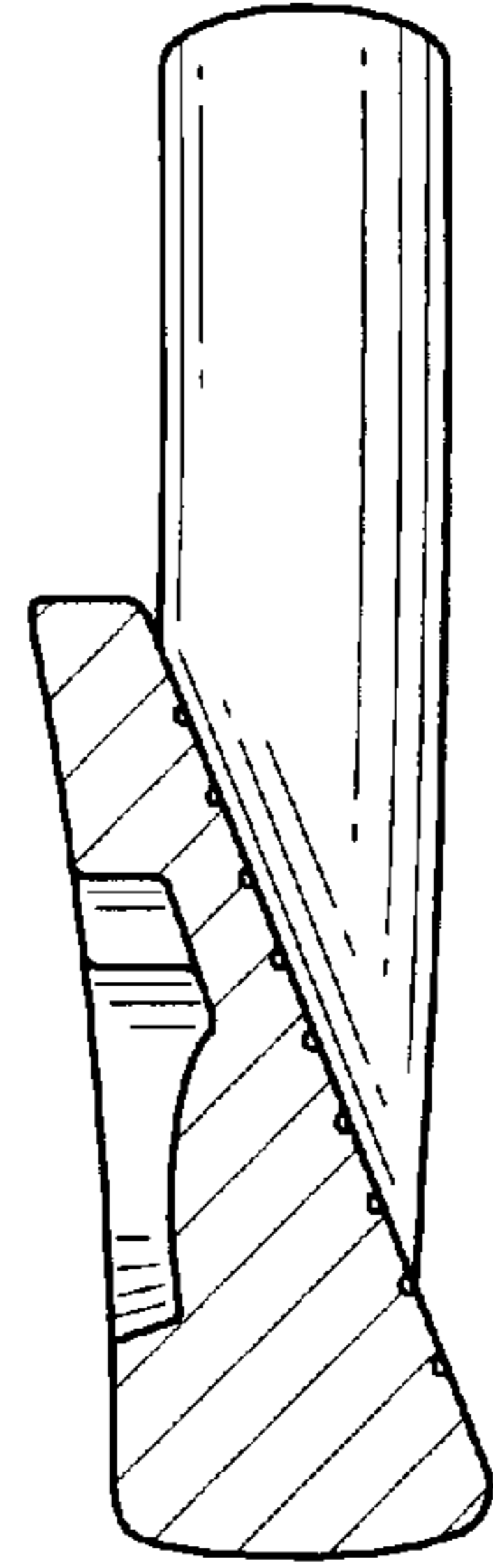

FIG. 6

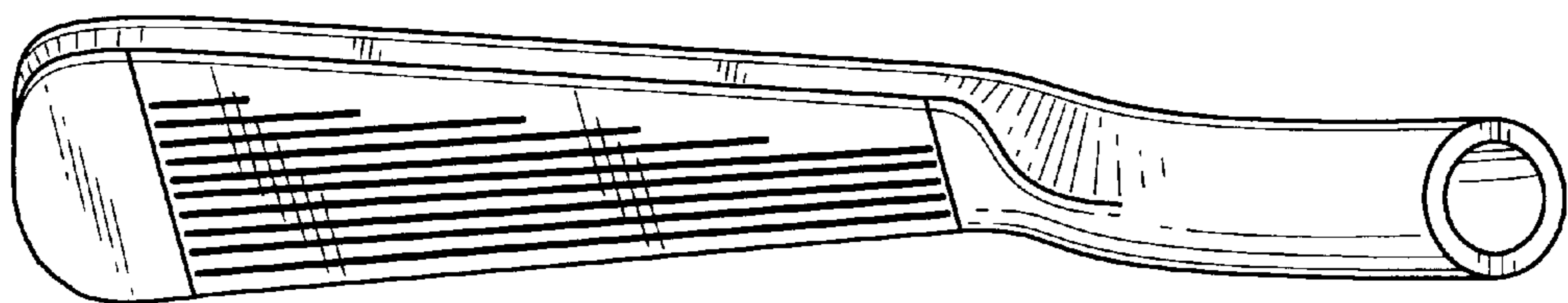
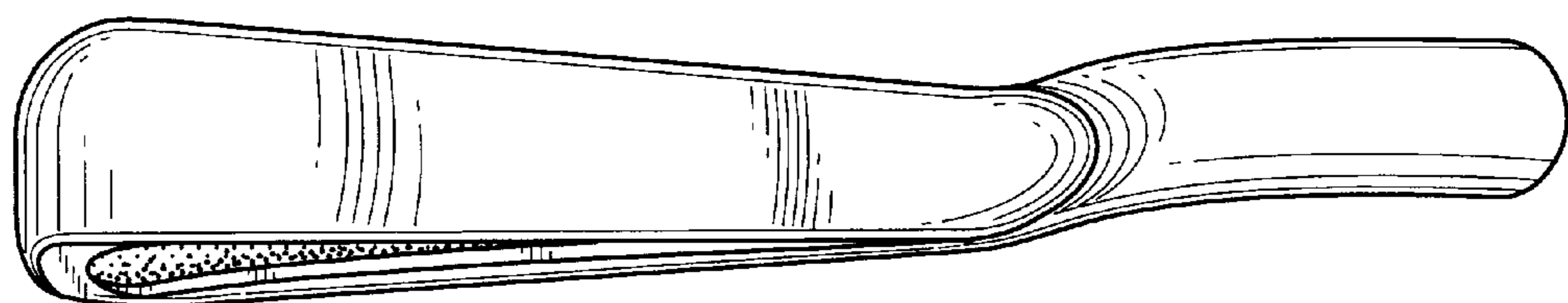

FIG. 7



UNITED STATES PATENT AND TRADEMARK OFFICE
CERTIFICATE OF CORRECTION

PATENT NO. : Des. 428,633
DATED : July 25, 2000
INVENTOR(S) : Yu Hasebe

It is certified that error appears in the above-identified patent and that said Letters Patent is hereby corrected as shown below:

Title page, item [75],

Please change the inventor's name from "Yu Hasebe" to --Yu Hasebe--.

Signed and Sealed this
Tenth Day of April, 2001

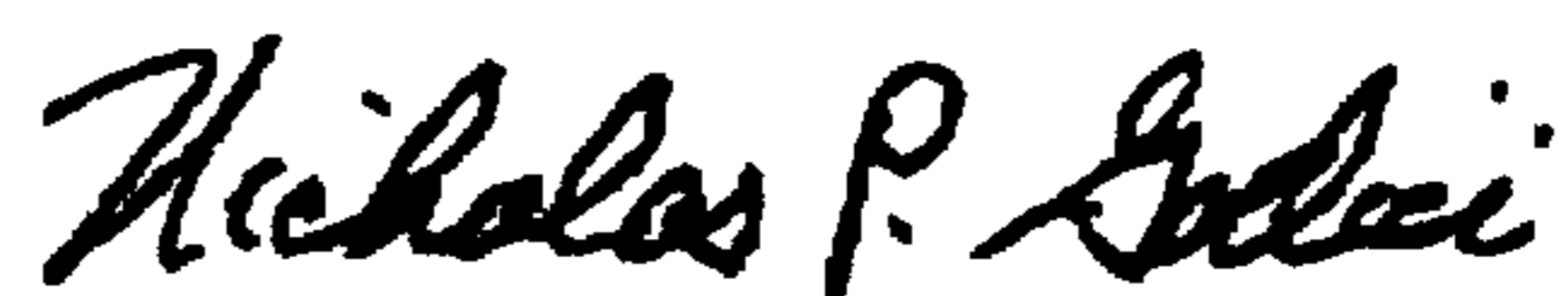

Attest:

NICHOLAS P. GODICI

Attesting Officer

Acting Director of the United States Patent and Trademark Office