



US00D428448S

United States Patent [19] Kitamori

[11] Patent Number: **Des. 428,448**

[45] Date of Patent: **** Jul. 18, 2000**

[54] **HAND HELD GAME MACHINE**

[75] Inventor: **Hiroki Kitamori**, Suita, Japan

[73] Assignee: **SNK Corporation**, Japan

[**] Term: **14 Years**

[21] Appl. No.: **29/105,696**

[22] Filed: **May 27, 1999**

[30] **Foreign Application Priority Data**

Dec. 16, 1998 [JP] Japan 10-36427

[51] **LOC (7) Cl.** **21-01**

[52] **U.S. Cl.** **D21/329**

[58] **Field of Search** D21/324, 329-331,
D21/333; D14/117.1, 117.9, 124, 125; 273/148 B;
463/1, 29-30, 46, 47

[56] **References Cited**

U.S. PATENT DOCUMENTS

D. 264,099	4/1982	Hanzawa	D21/329
D. 320,624	10/1991	Taylor	D21/331
D. 328,474	8/1992	Chen	D21/331
D. 332,804	1/1993	Li	D21/331
D. 370,237	5/1996	Gilliam et al.	D21/13
D. 380,501	7/1997	Osterhout et al.	D21/331
D. 382,914	8/1997	Ho et al.	D21/331
D. 397,368	8/1998	Rissman	D21/329
D. 414,522	9/1999	Kitamori	D21/329

4,438,926	3/1984	Yokoi et al.	463/29
5,161,803	11/1992	Ohara	273/435
5,184,830	2/1993	Okada et al.	D21/331 X
5,213,327	5/1993	Kitae	463/46 X

OTHER PUBLICATIONS

Hongkong Enterprise, pp. 128 and 133, Oct. 1994.

Primary Examiner—Prabhakar Deshmukh
Attorney, Agent, or Firm—Sheppard, Mullin, Richter & Hampton LLP; John A. Griecci

[57] **CLAIM**

I claim the ornamental design for a hand held game machine, as shown and described.

DESCRIPTION

FIG. 1 is a top plan view of an embodiment of a hand held game machine embodying the new design.

FIG. 2 is a right side view of the embodiment depicted in FIG. 1.

FIG. 3 is a left side view of the embodiment depicted in FIG. 1.

FIG. 4 is a front elevational view of the embodiment depicted in FIG. 1.

FIG. 5 is a rear view of the embodiment depicted in FIG. 1.

FIG. 6 is a perspective view of the embodiment depicted in FIG. 1; and,

FIG. 7 is a bottom plan view of the embodiment depicted in FIG. 1.

1 Claim, 3 Drawing Sheets

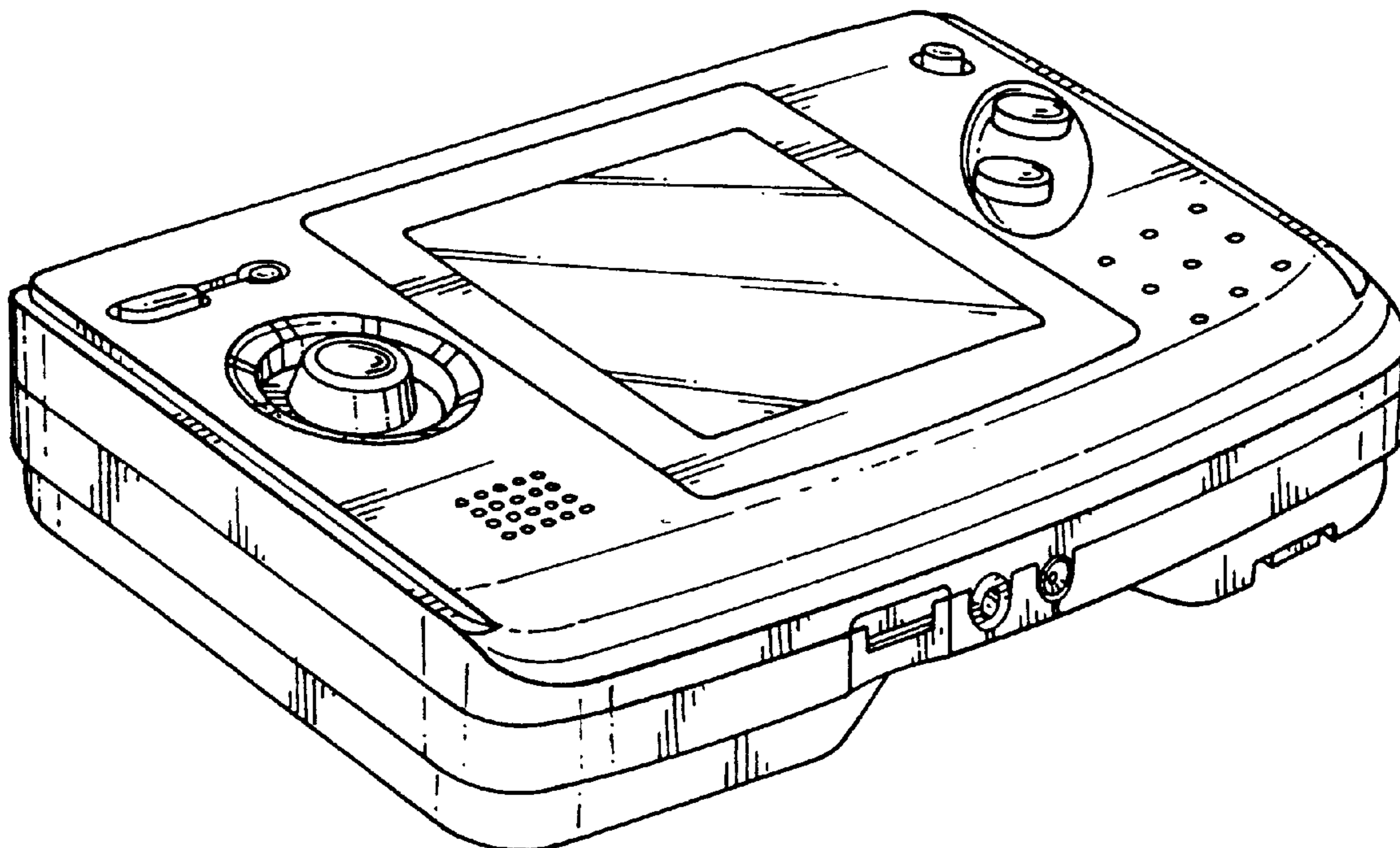

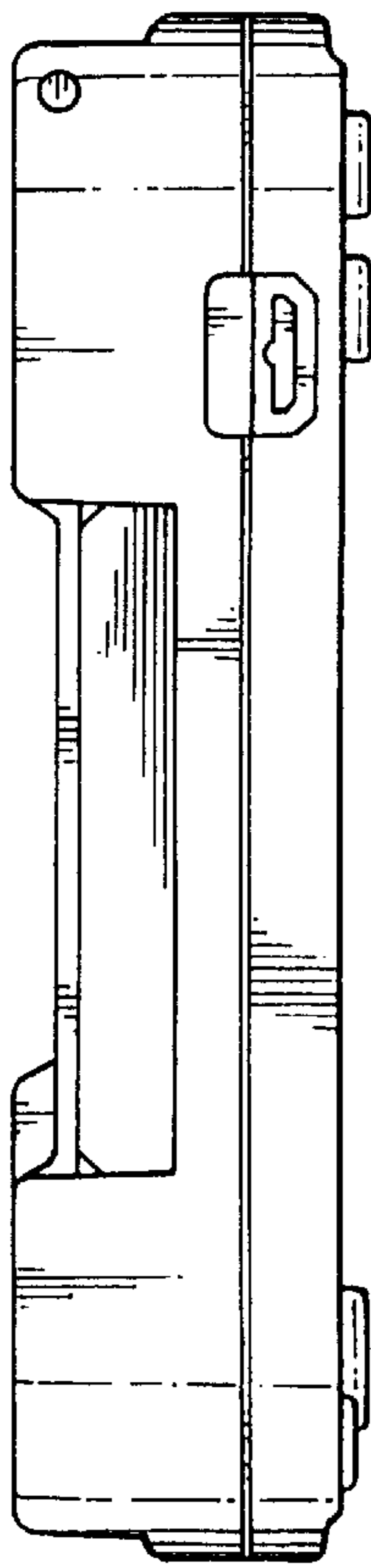

FIG. 5

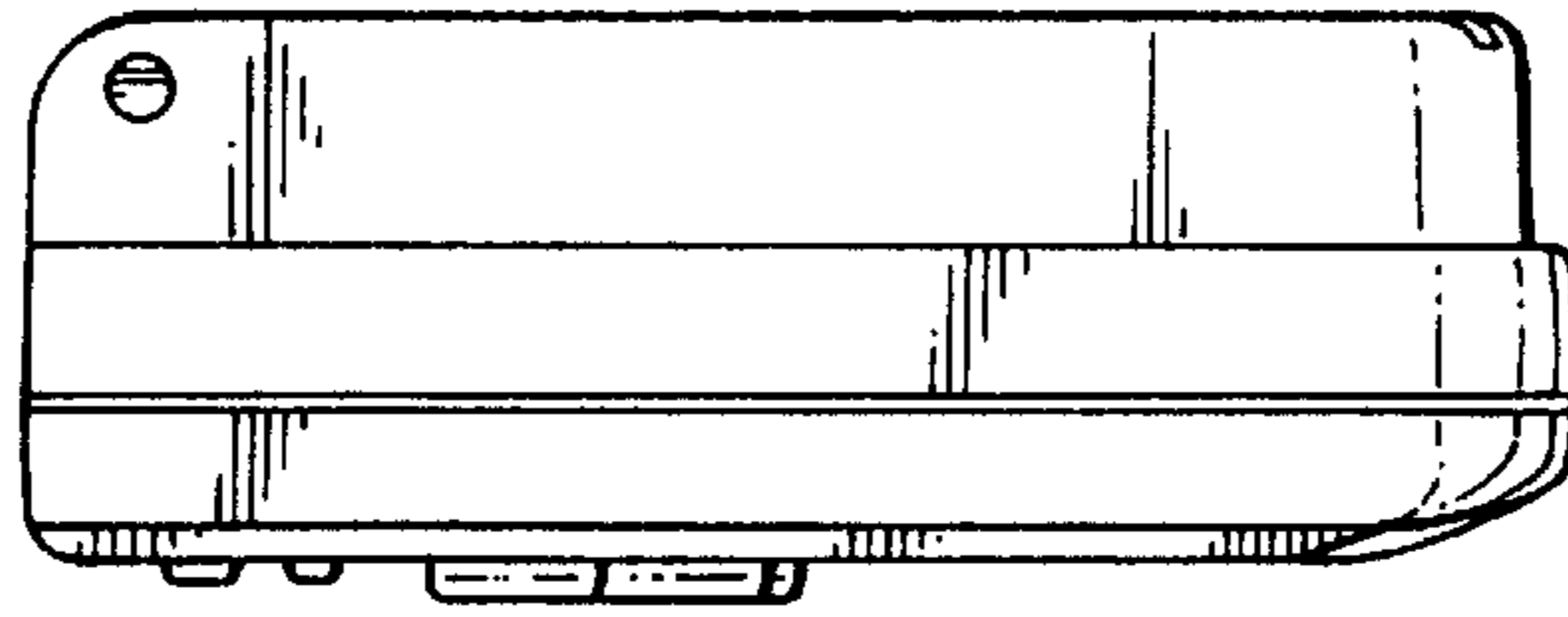

FIG. 2

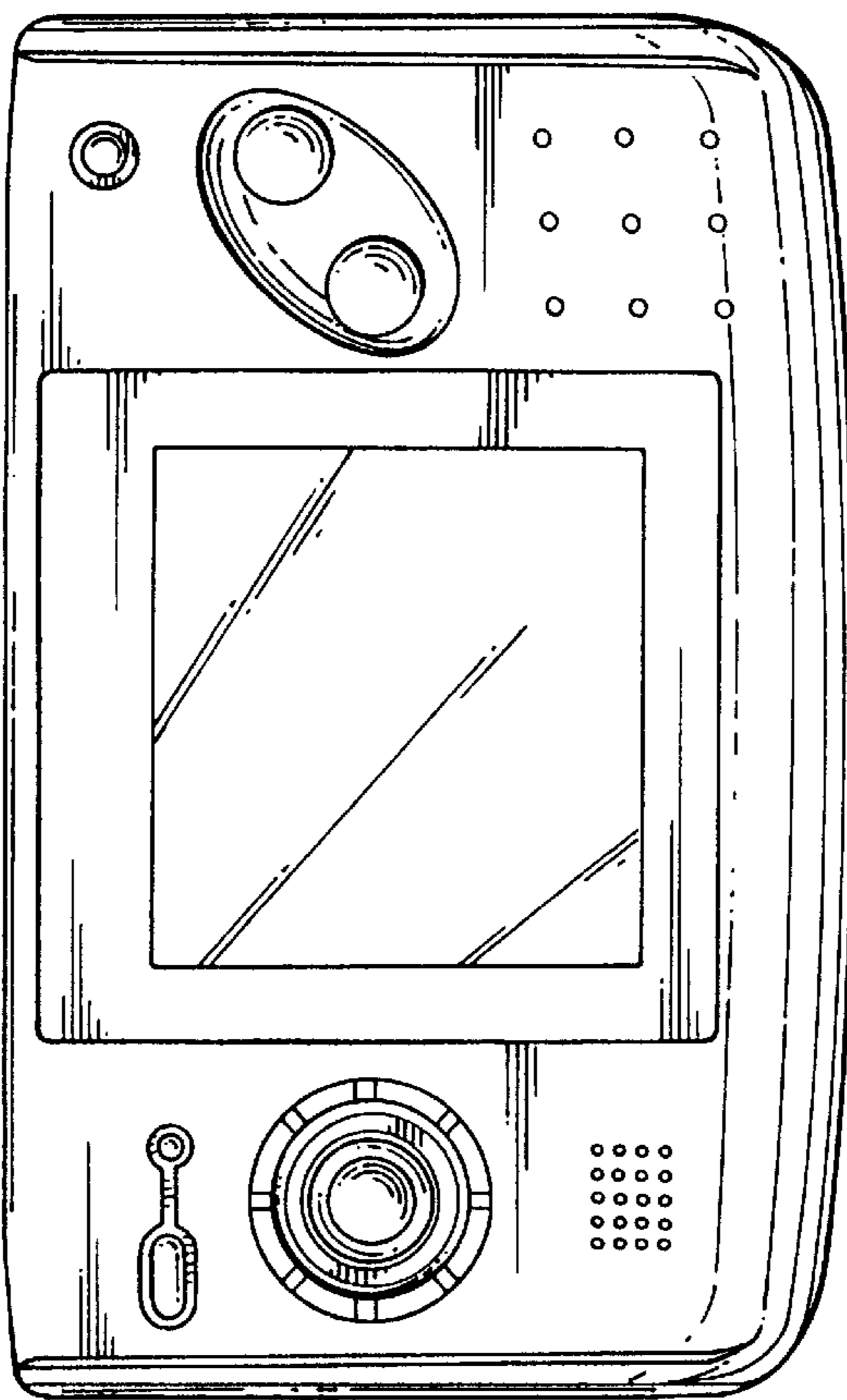

FIG. 1

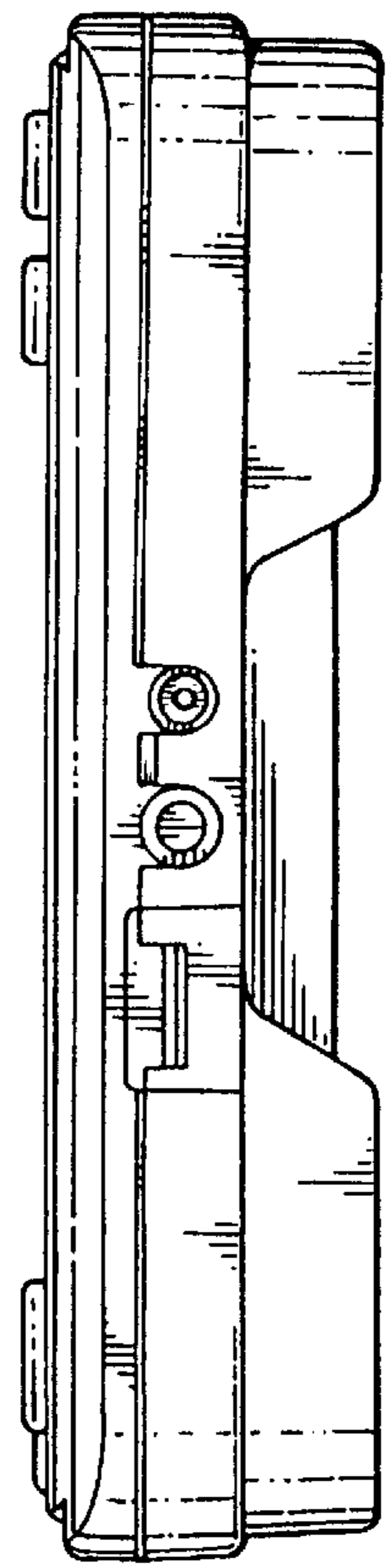

FIG. 4

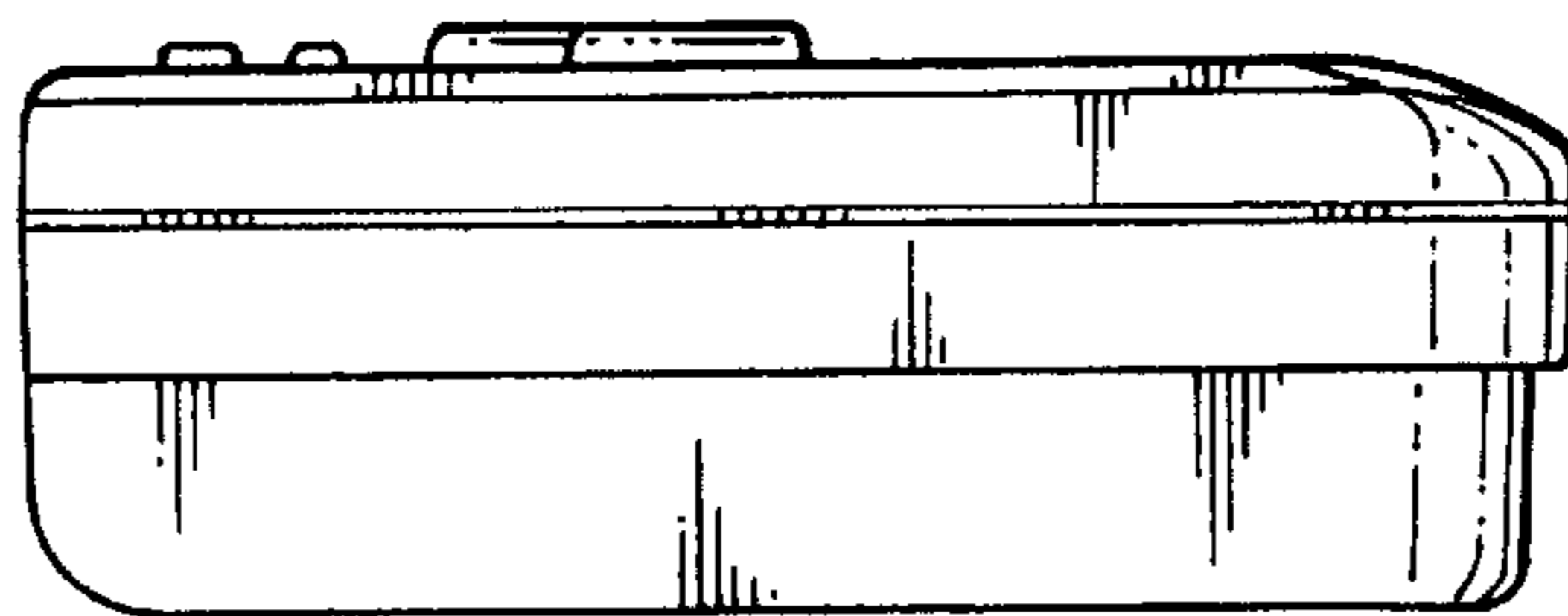

FIG. 3

FIG. 6

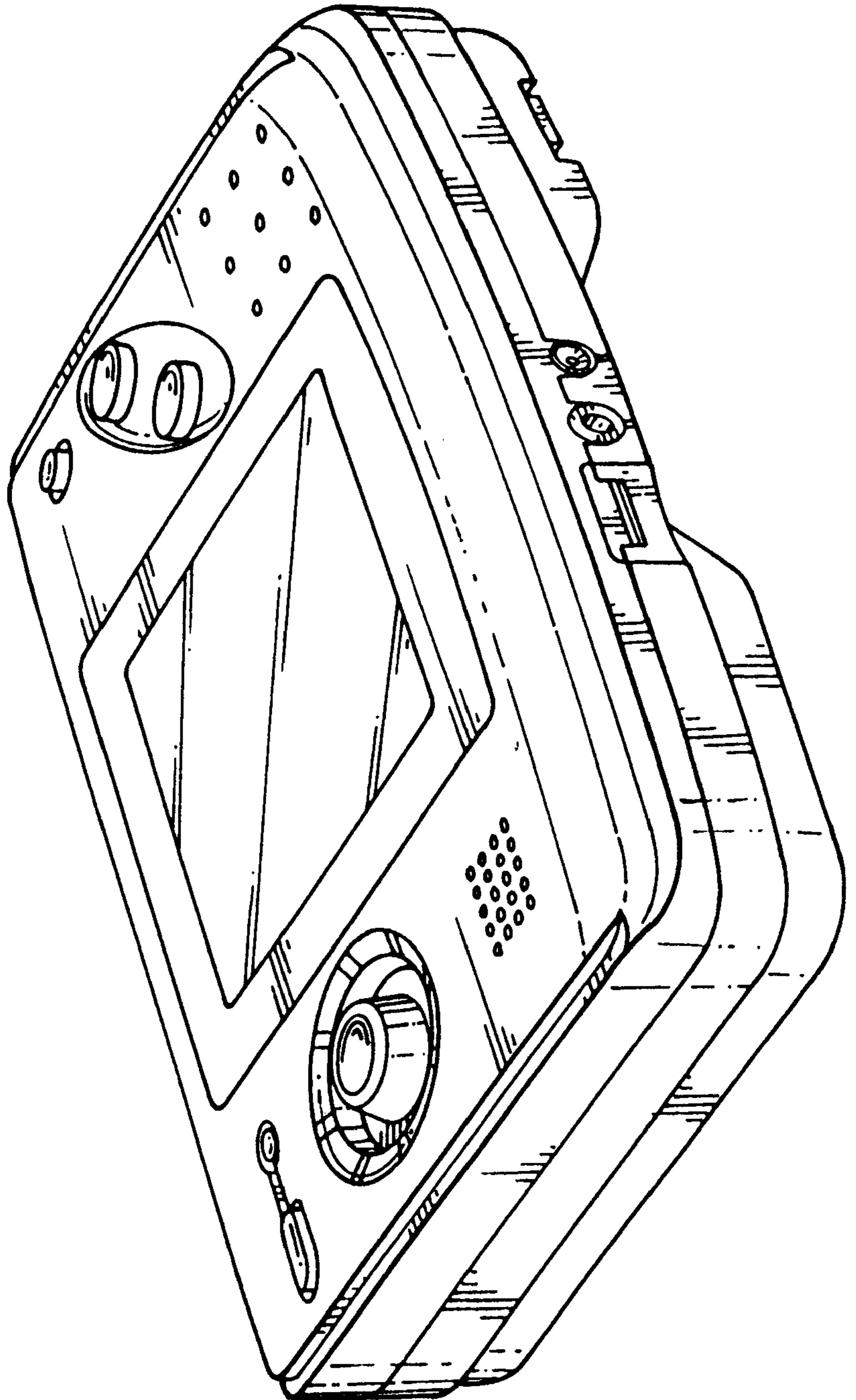

FIG. 7

