

U.S. PATENT DOCUMENTS

D. 375,756	11/1996	Murray et al.	D18/56
D. 378,660	4/1997	Ota et al.	D9/417
D. 391,986	3/1998	Steinmetz et al.	D18/56
4,131,899	12/1978	Christou .	
4,551,734	11/1985	Causley et al. .	
4,568,954	2/1986	Rosback .	
4,959,667	9/1990	Kaplinsky .	
5,216,452	6/1993	Suzuki .	
5,477,963	12/1995	Mochizuki et al. .	
5,541,631	7/1996	Hashimoto	347/86
5,583,545	12/1996	Pawlowski, Jr. et al.	347/86
5,629,728	5/1997	Karita et al.	347/87
5,646,664	7/1997	Pawlowski, Jr.	347/86
5,734,401	3/1998	Clark et al.	347/86
5,777,646	7/1998	Barinaga et al.	347/86
5,784,087	7/1998	Wallace et al.	347/86

5,825,387	10/1998	Cowger et al.	347/86
5,844,579	12/1998	Barinaga et al.	347/86
5,852,459	12/1998	Pawlowski, Jr. et al.	347/86
5,856,839	1/1999	Aukstikalnis et al.	347/86
5,856,840	1/1999	Barinaga et al.	347/86
5,860,363	1/1999	Childers et al.	347/86
5,900,896	5/1999	Barinaga et al.	347/86

FOREIGN PATENT DOCUMENTS

560266-A2	9/1993	European Pat. Off. .	
60-219061	11/1985	Japan .	
62-261451	11/1987	Japan .	
2-514	1/1990	Japan .	
2-243351	9/1990	Japan .	
3-184873	8/1991	Japan .	
3-248848	11/1991	Japan .	
6-218941	8/1994	Japan .	

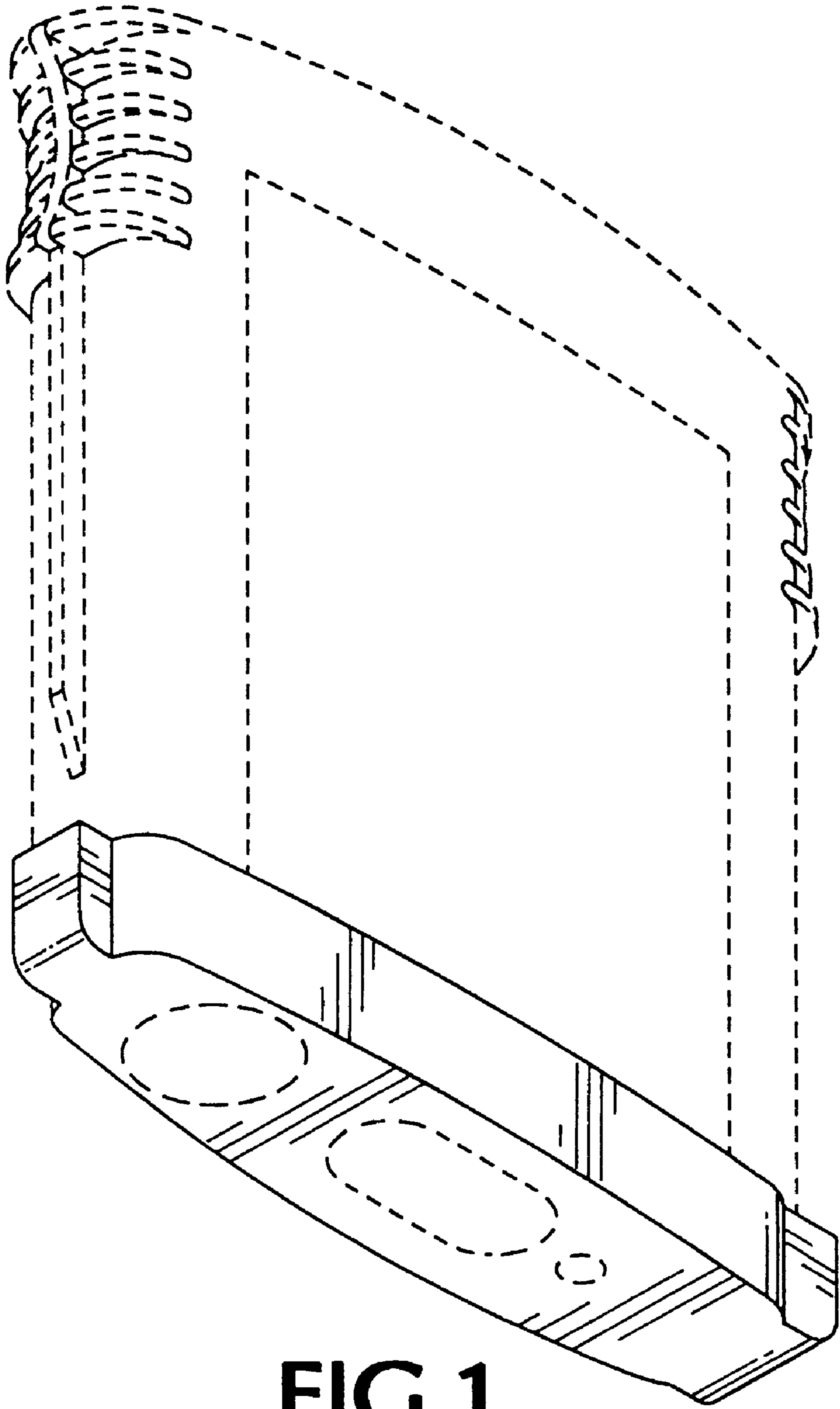

FIG. 1

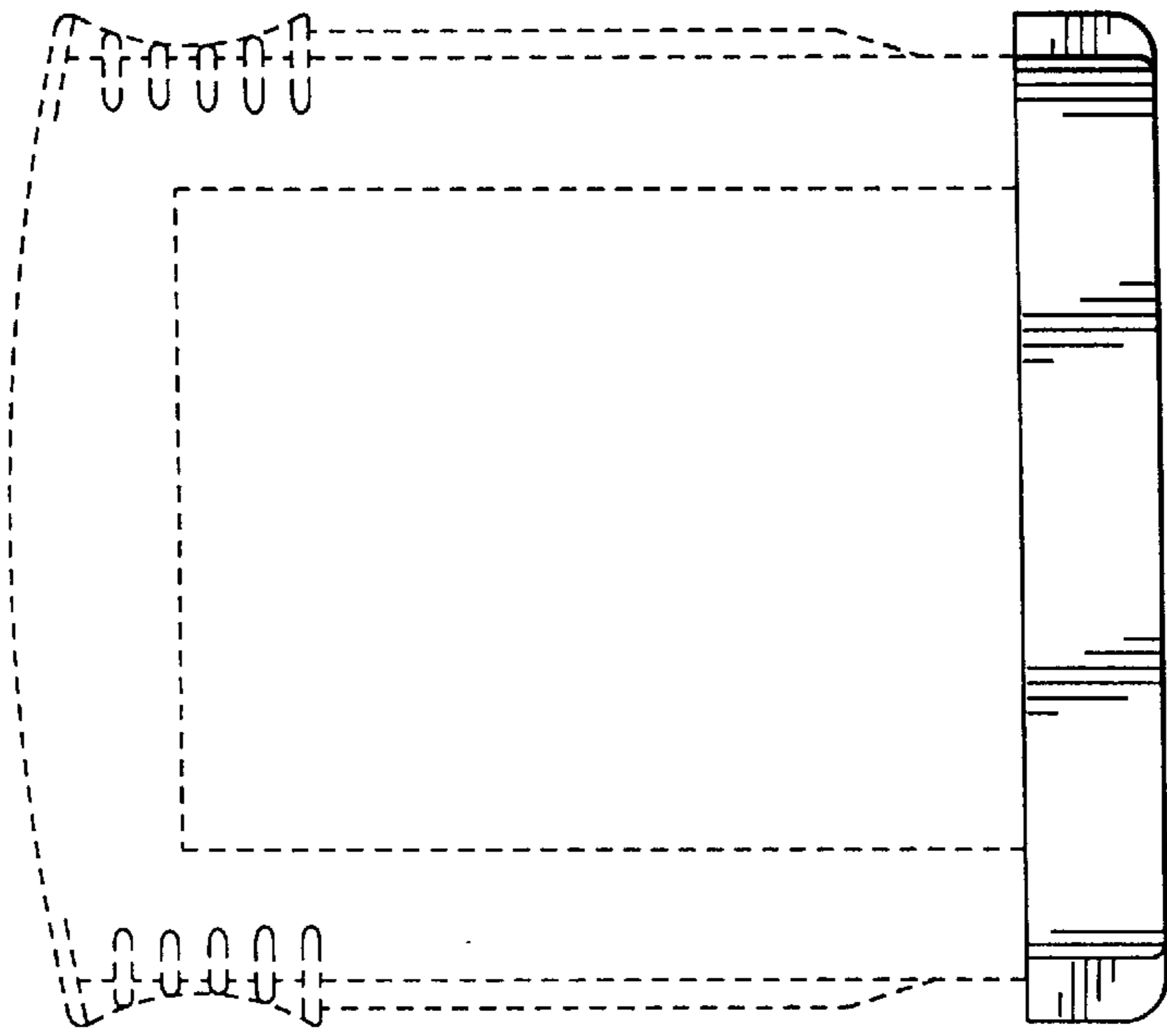

FIG. 2

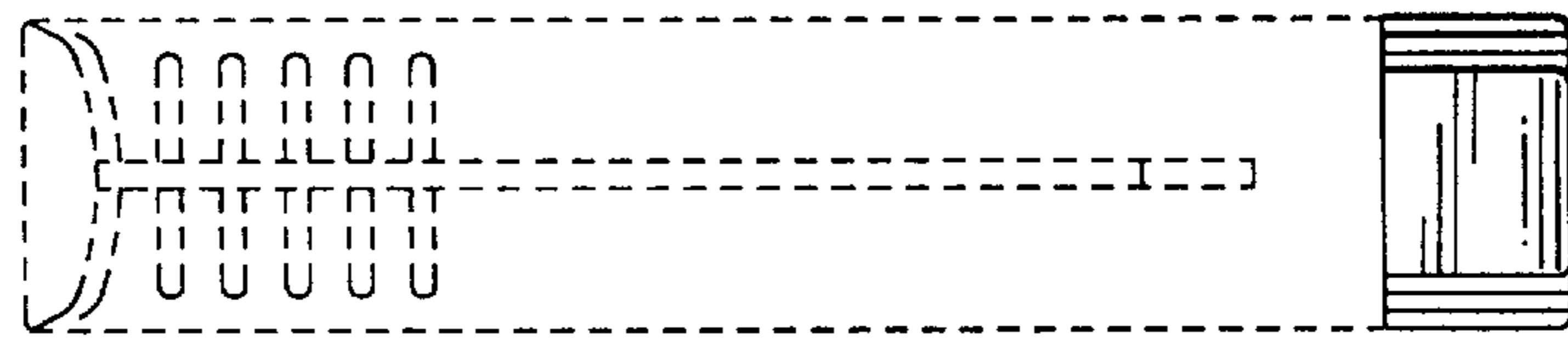

FIG. 3

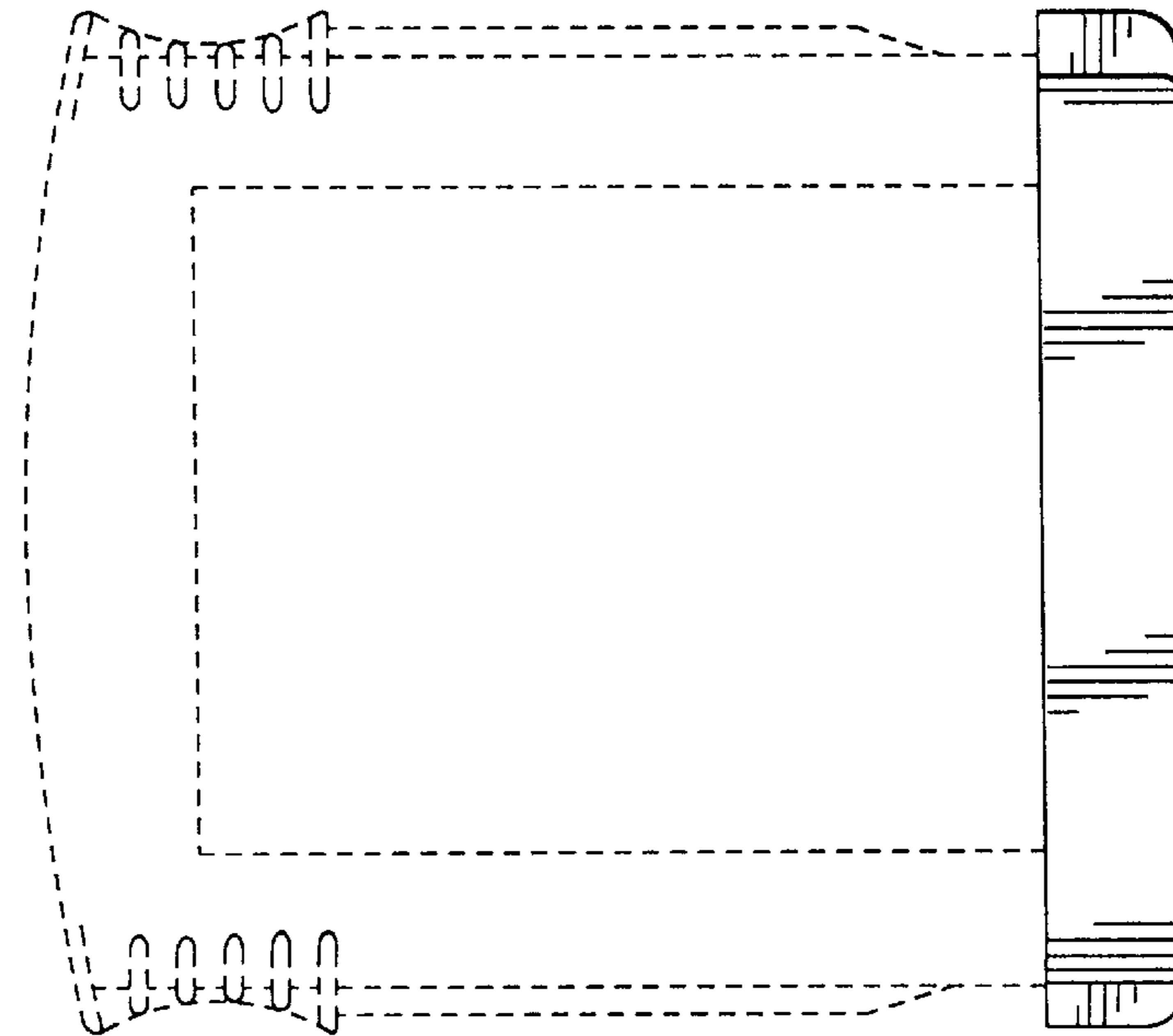

FIG. 4

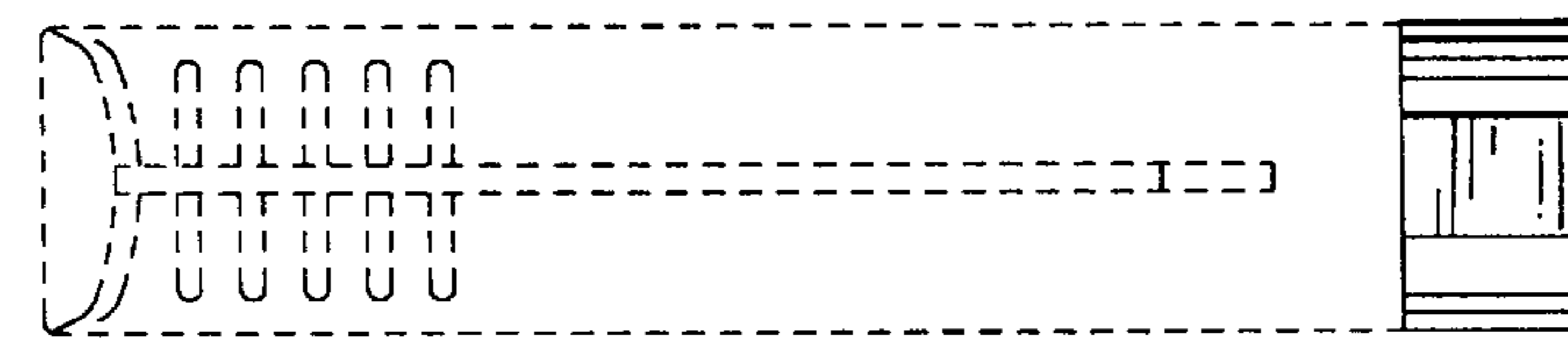

FIG. 5

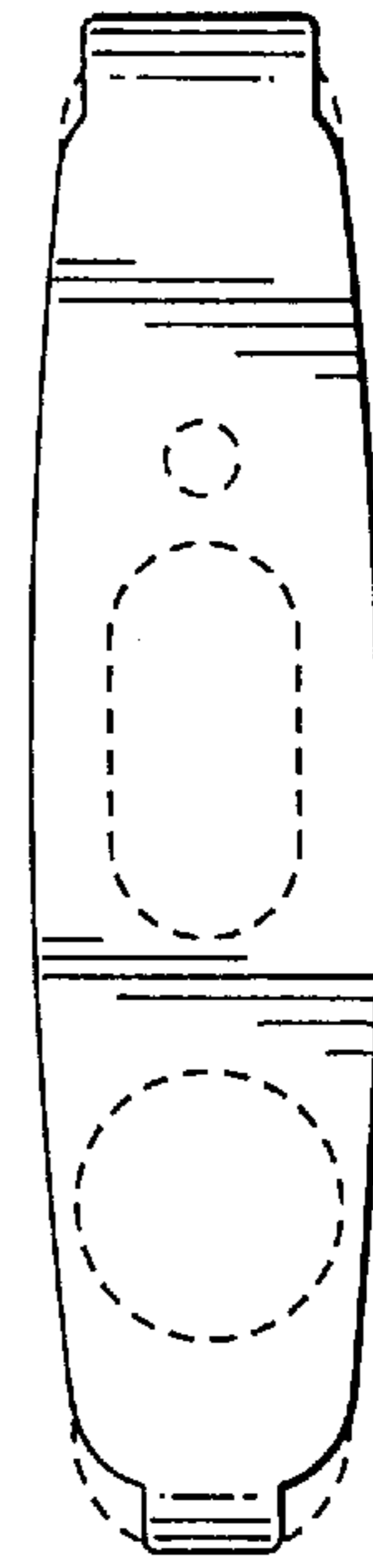

FIG. 6

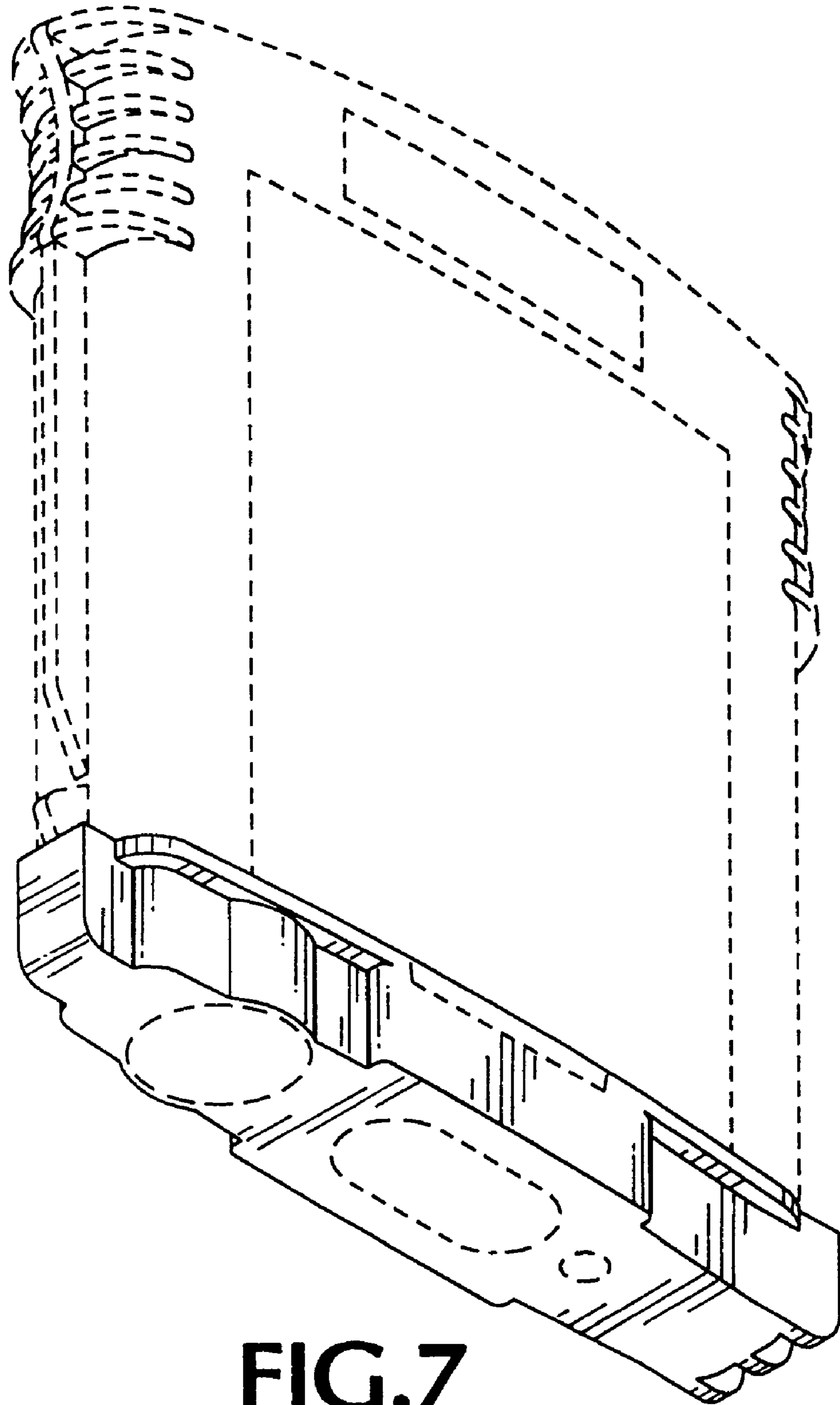

FIG. 7

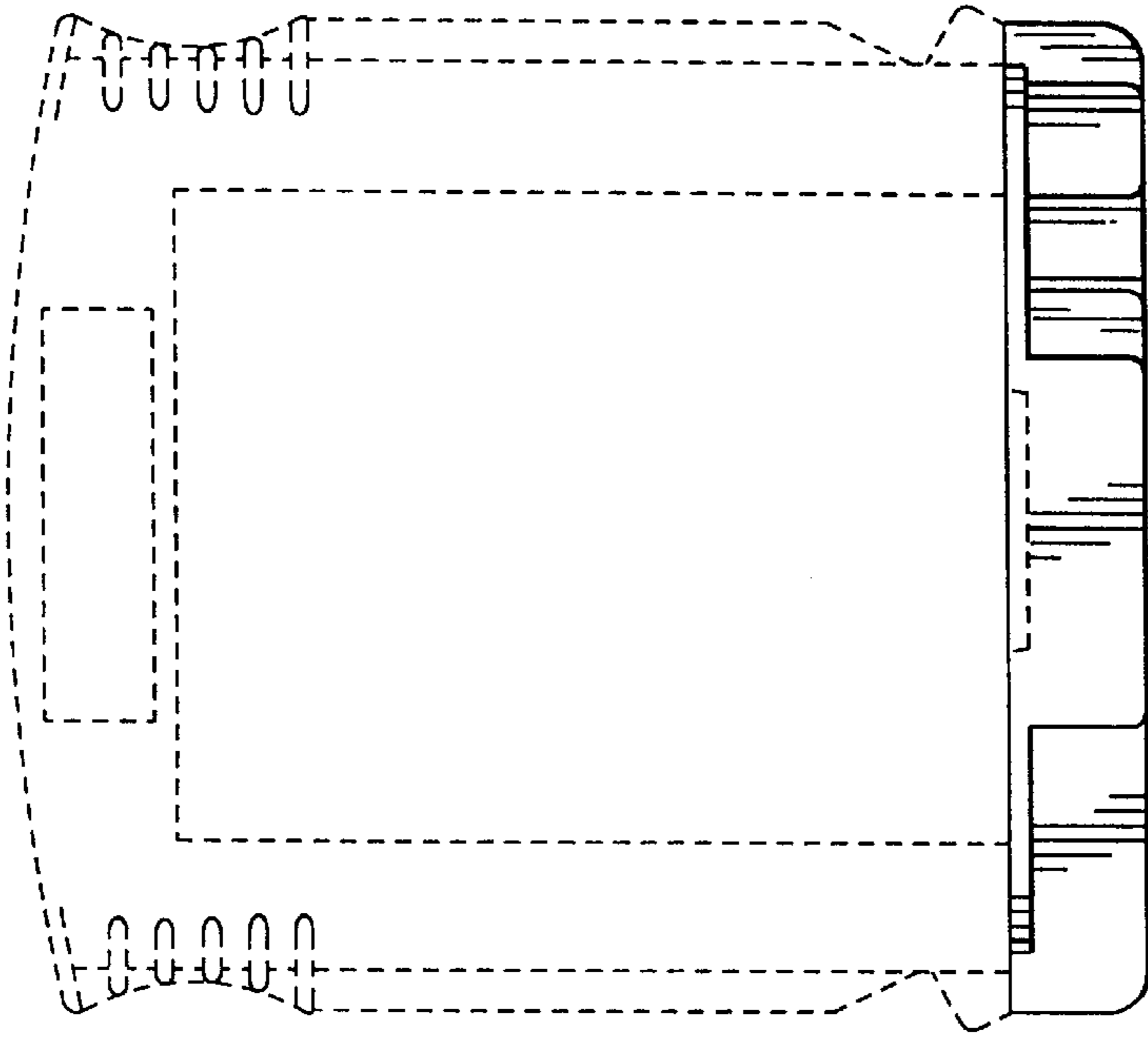

FIG. 8

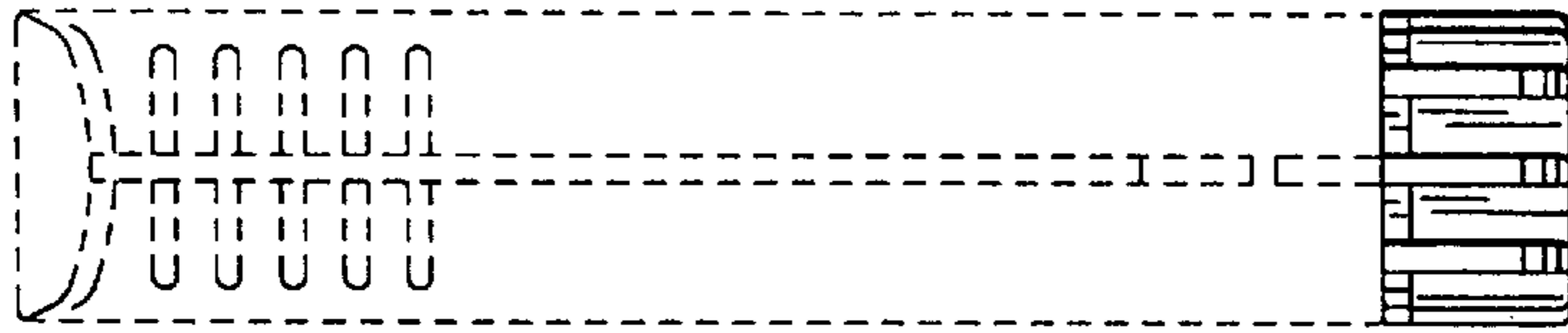

FIG. 9

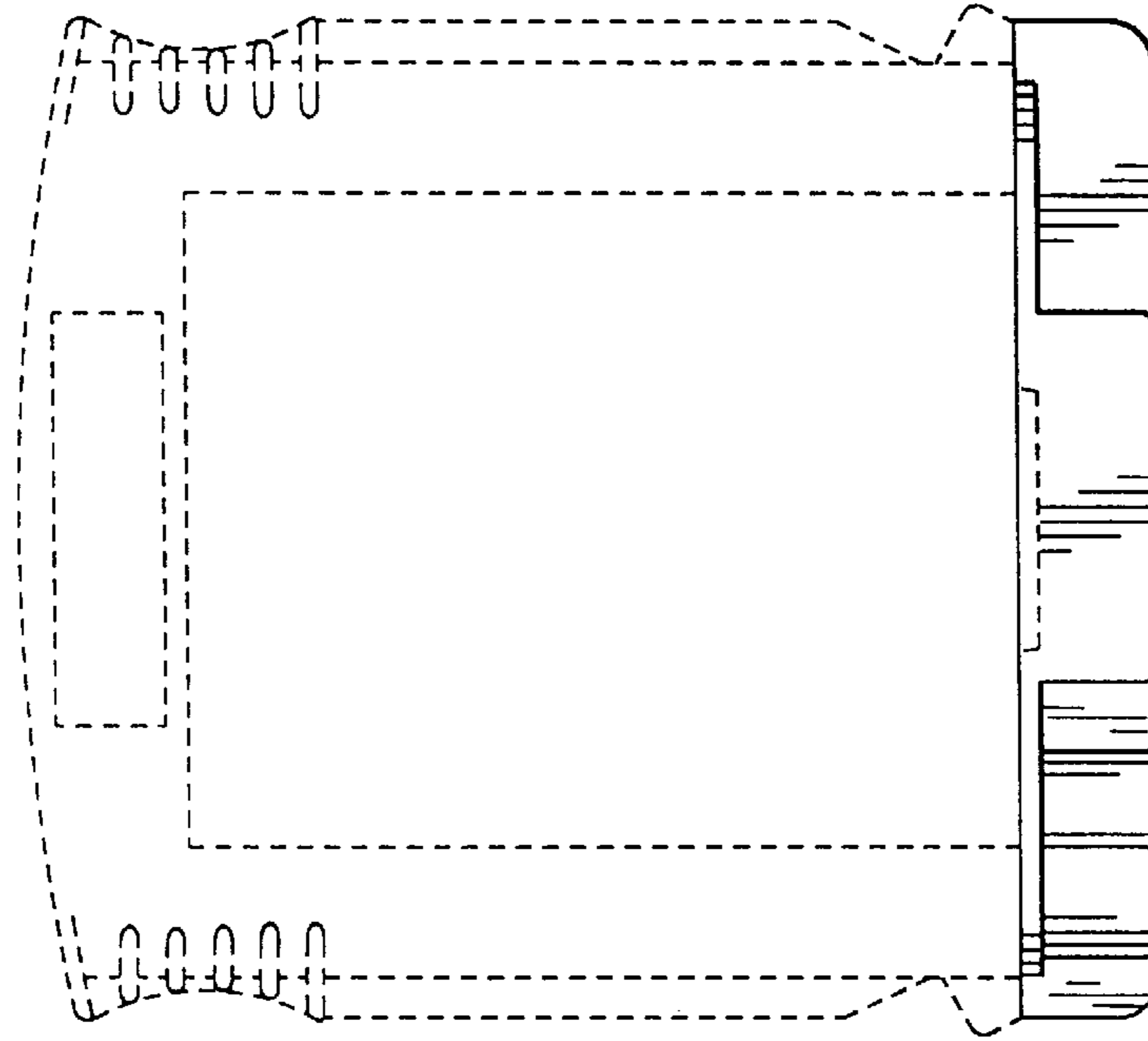

FIG. 10

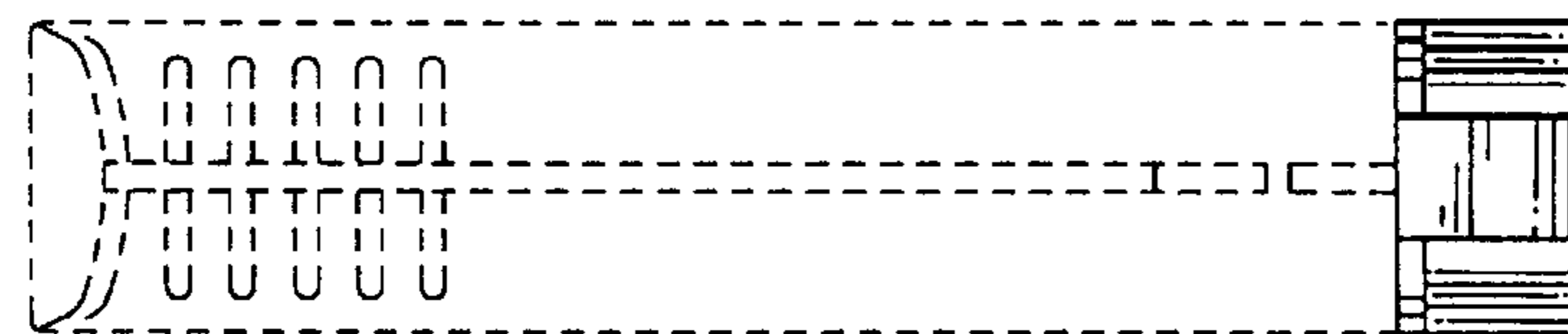

FIG. 11

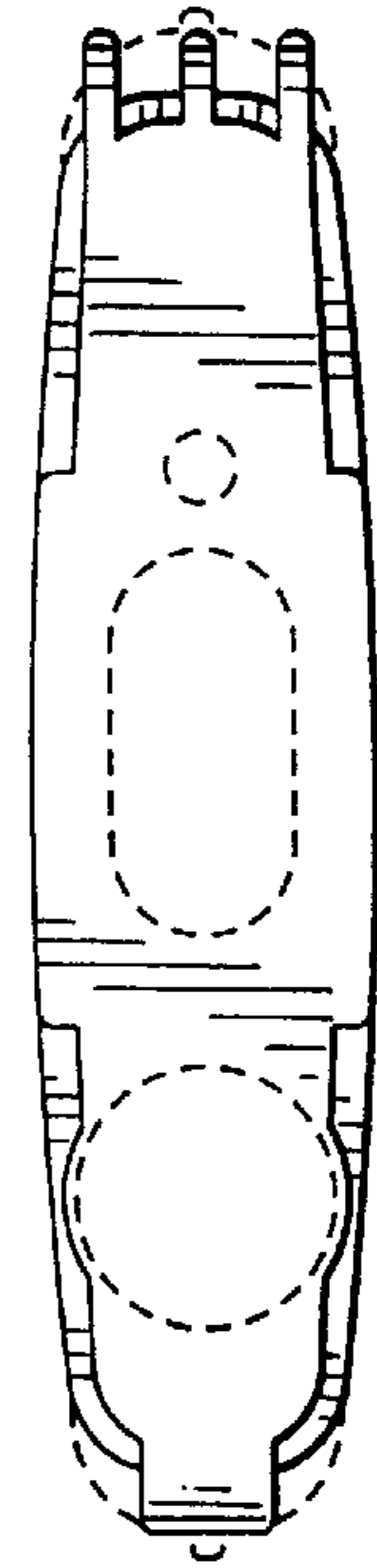

FIG. 12

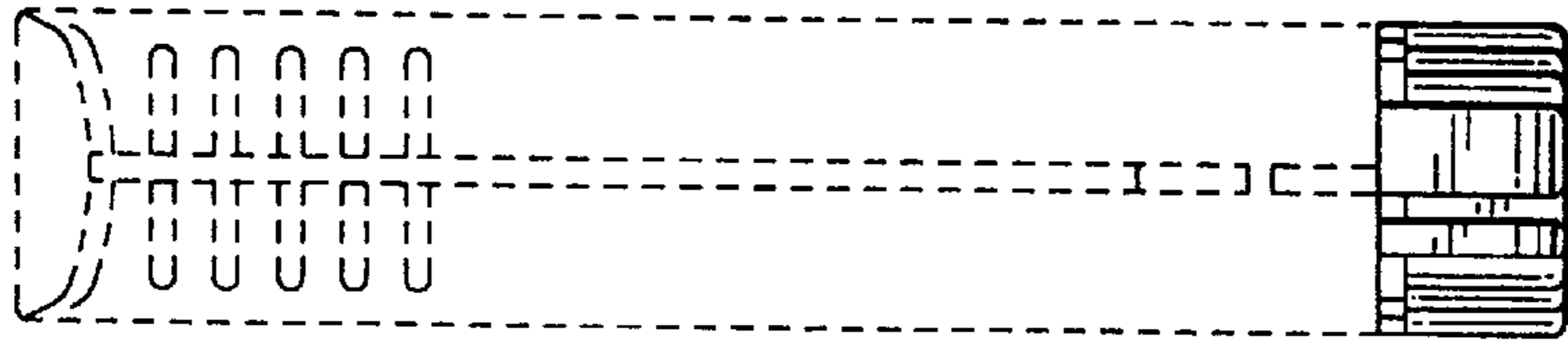

FIG. 13

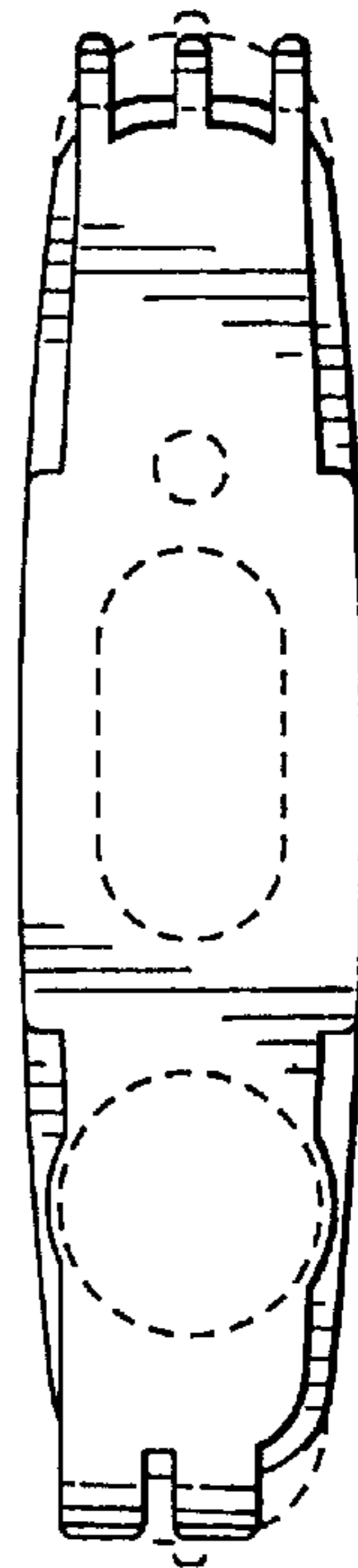

FIG. 14

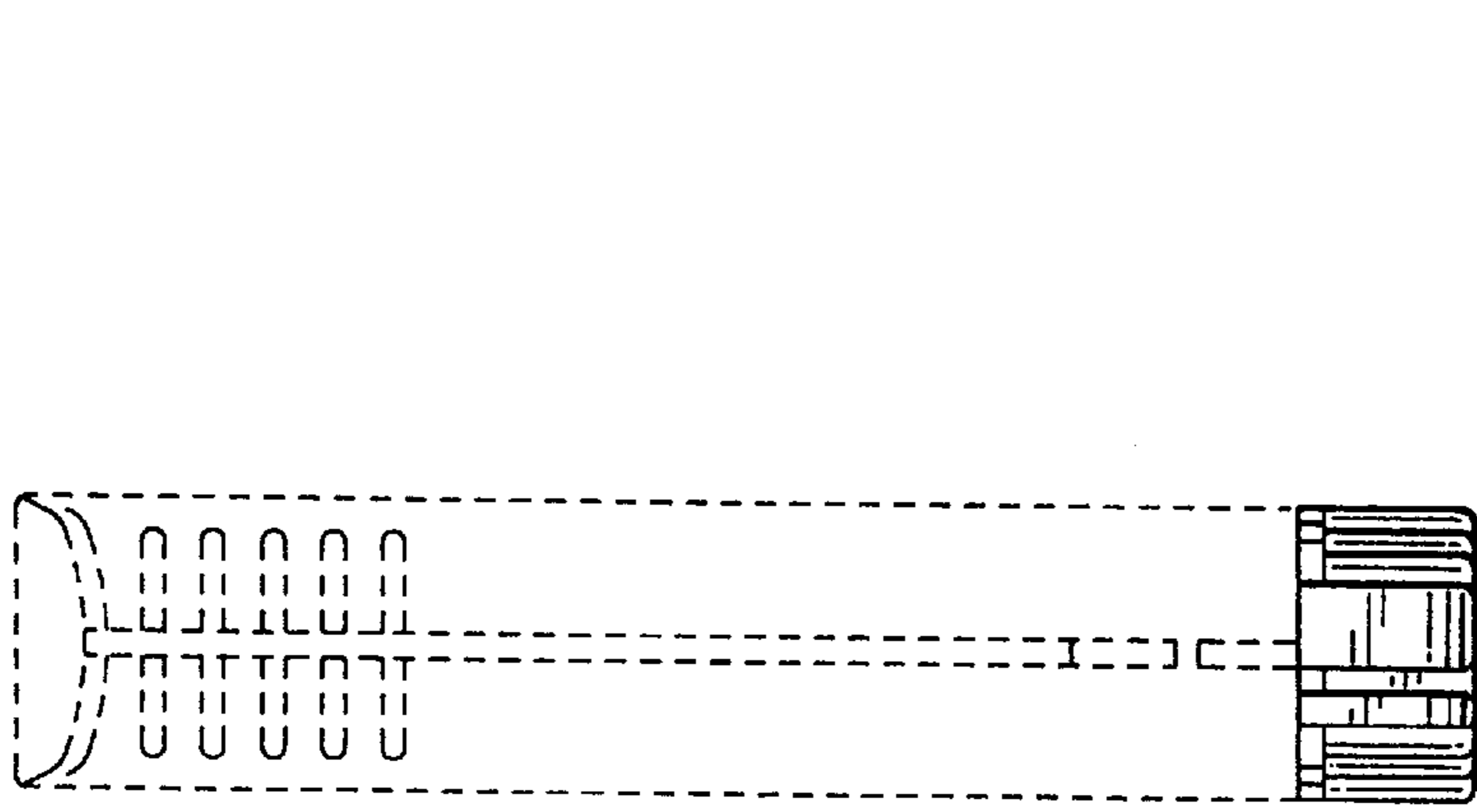

FIG. 15

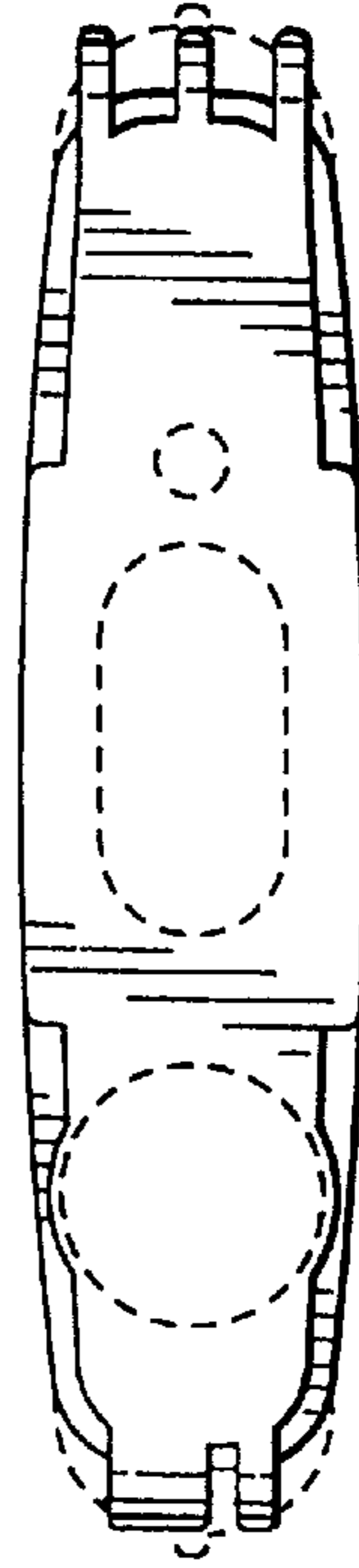

FIG. 16

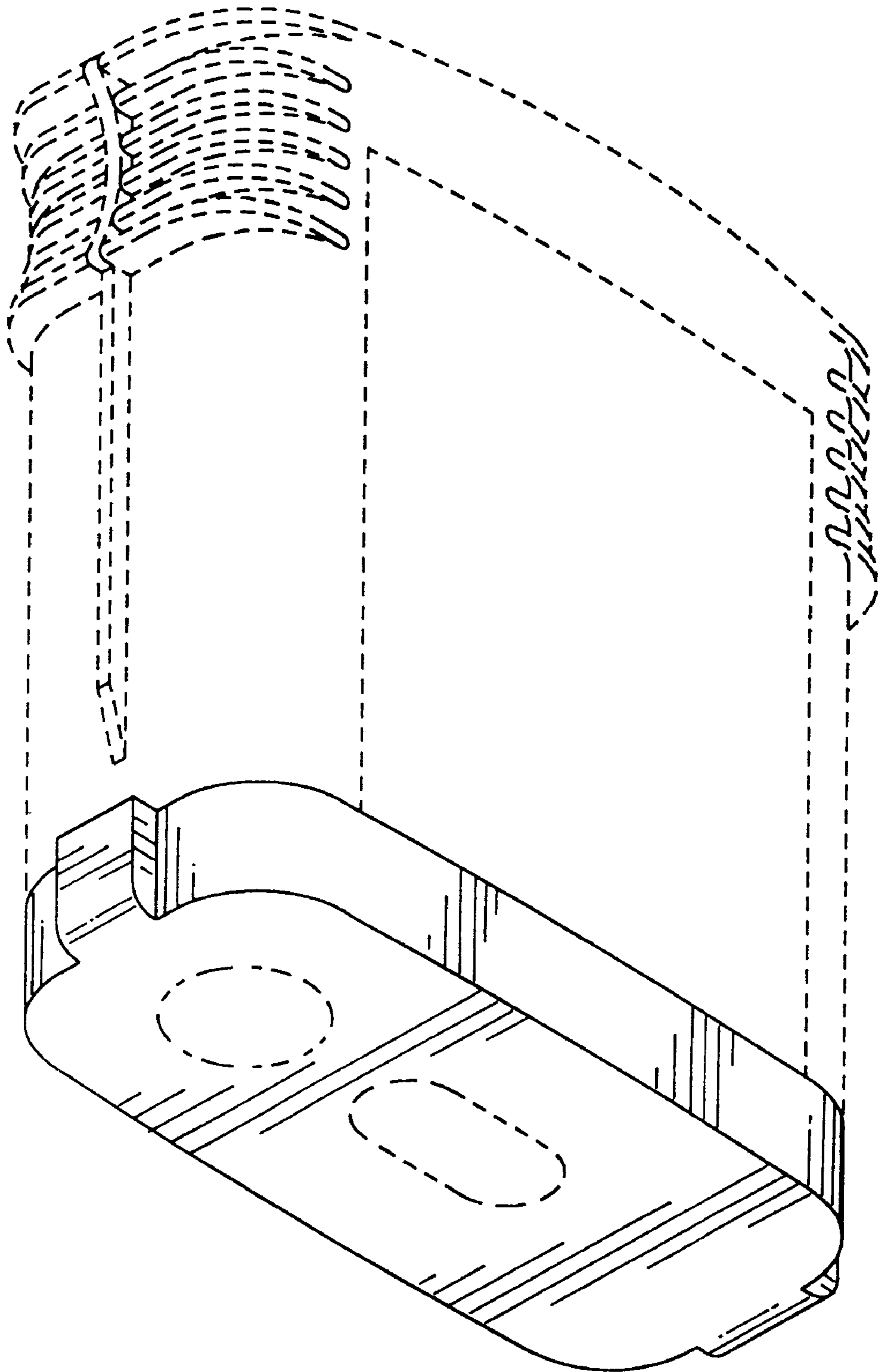

FIG.17

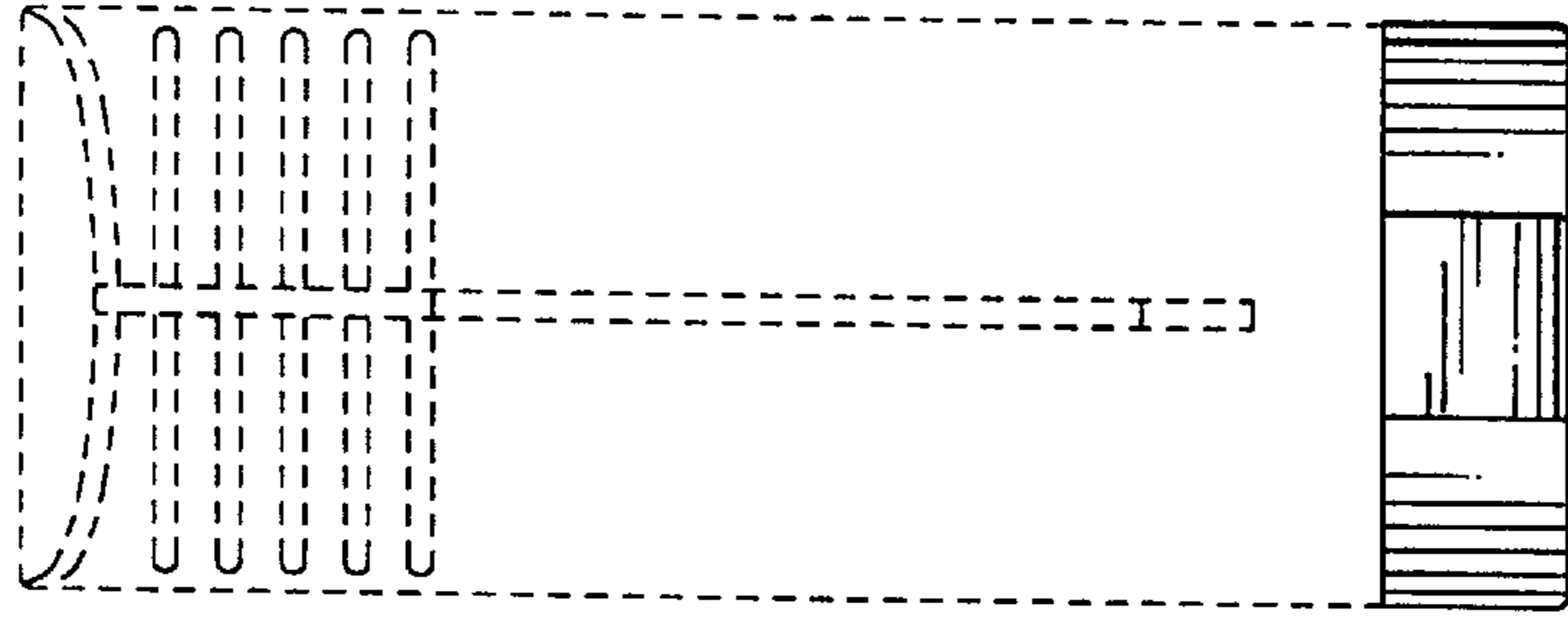

FIG. 18

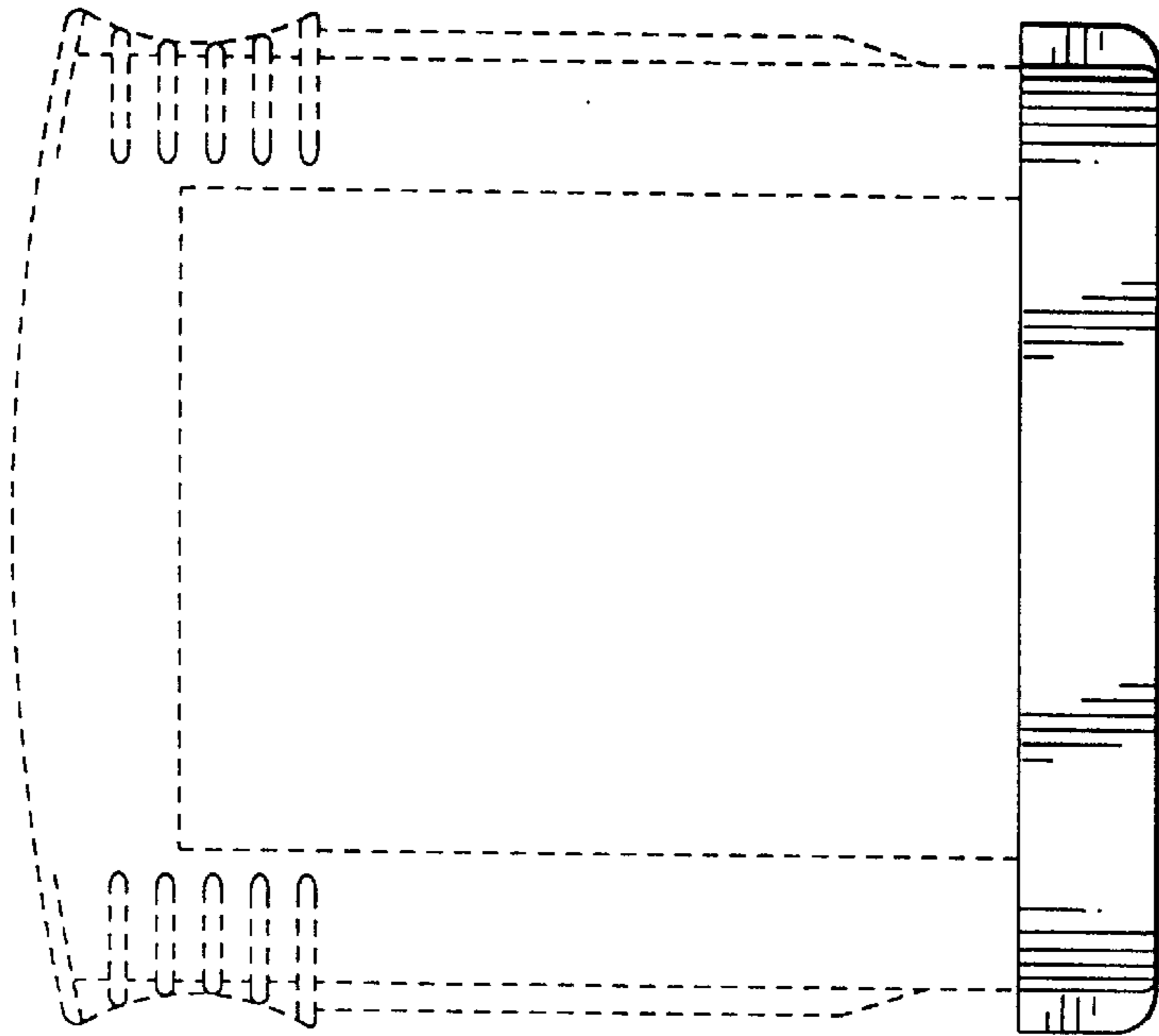

FIG. 19

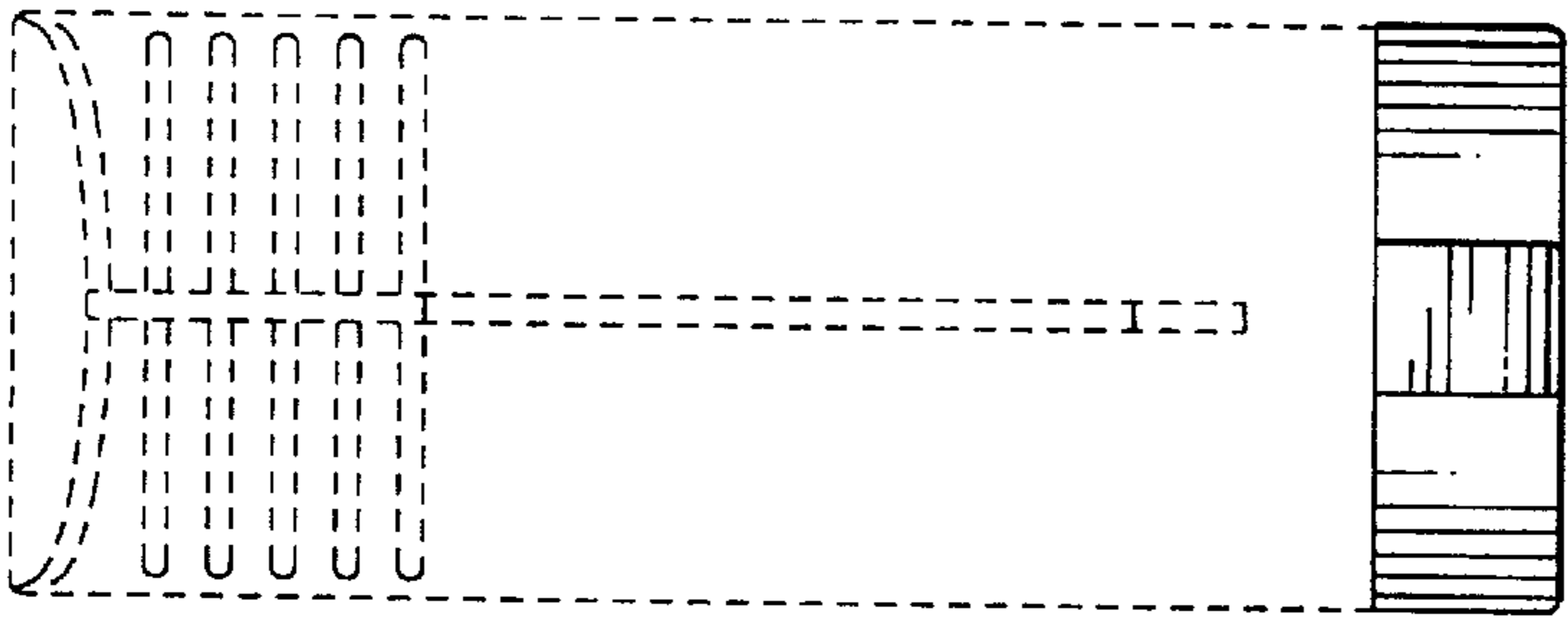

FIG. 20

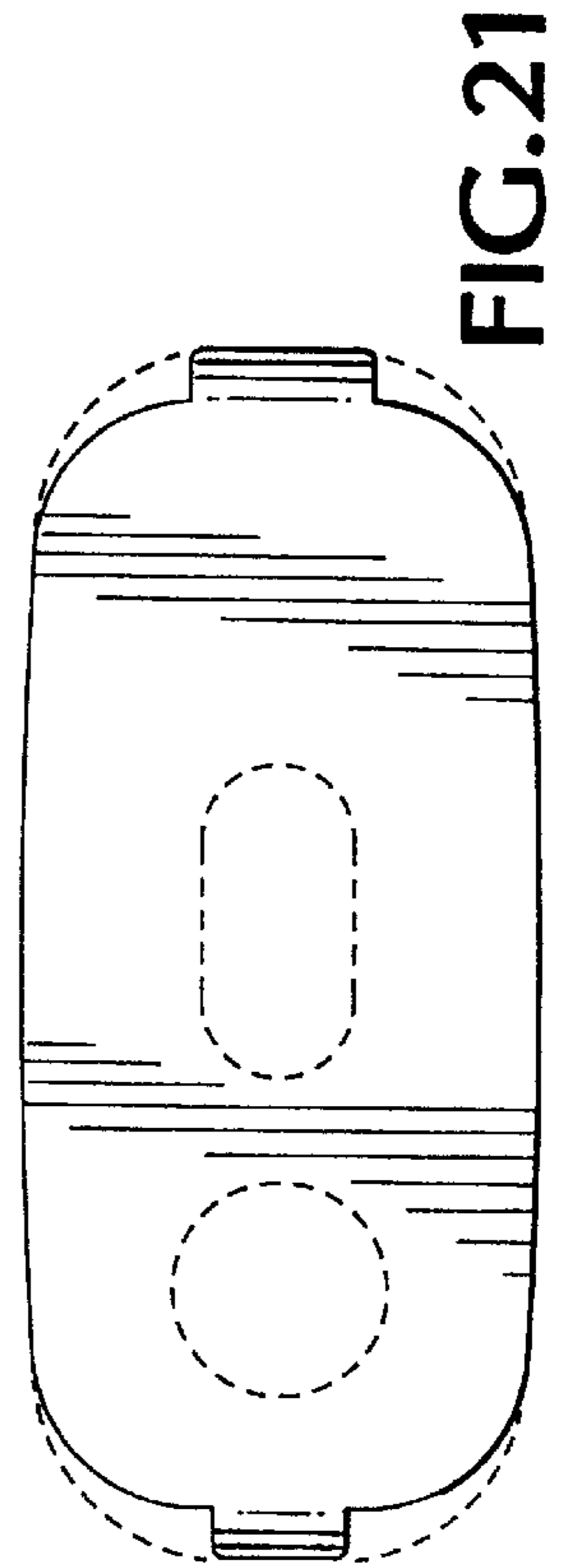

FIG. 21

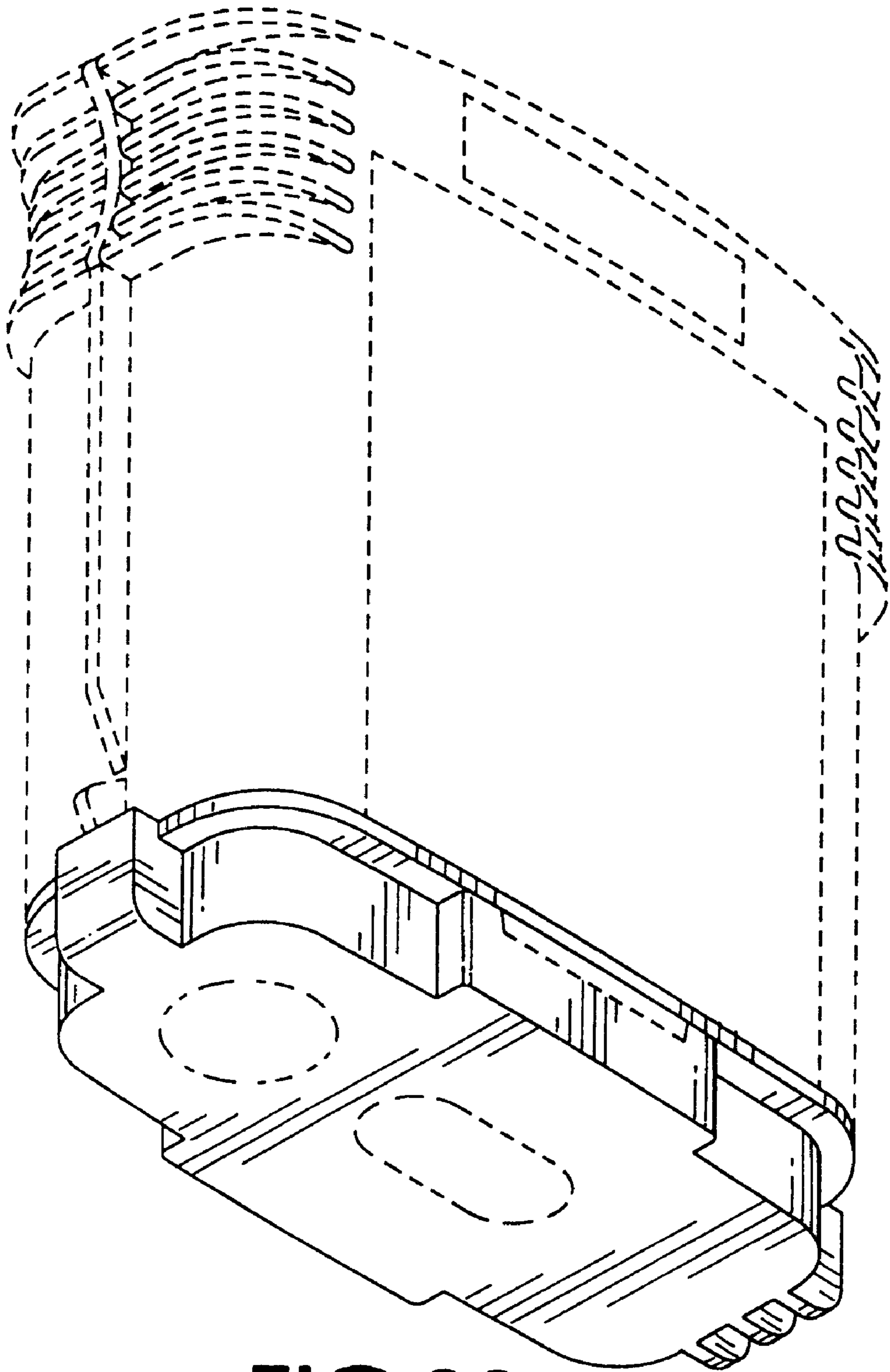

FIG.22

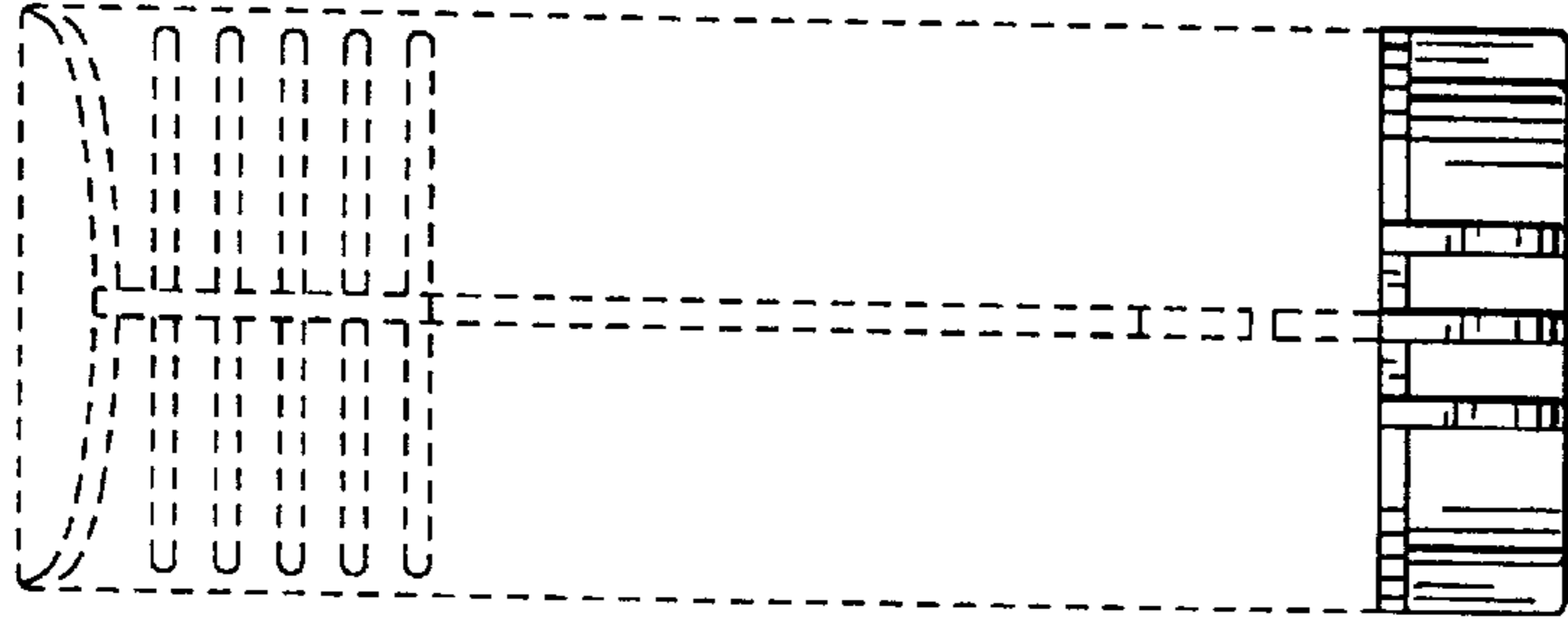

FIG. 25

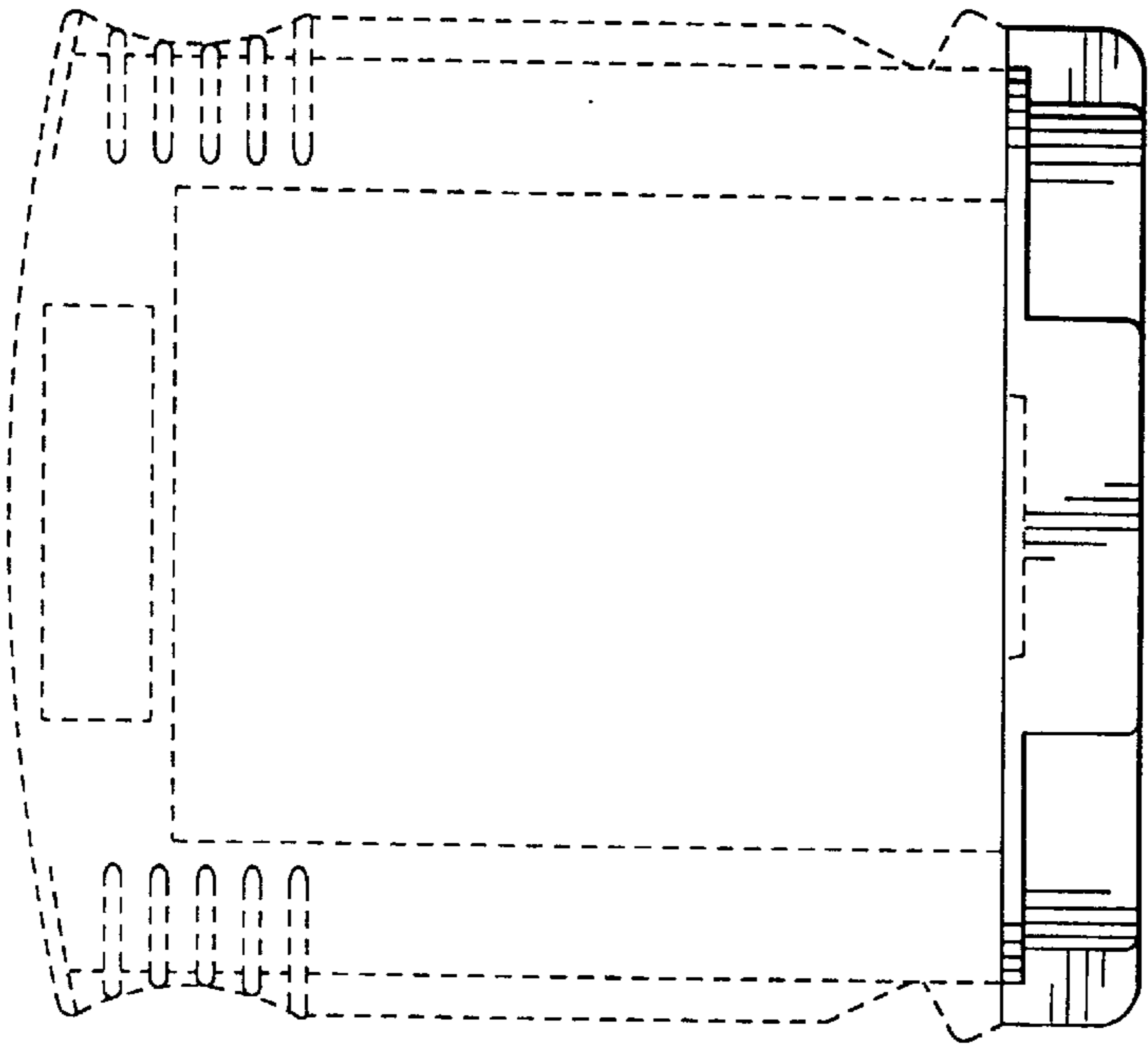

FIG. 23

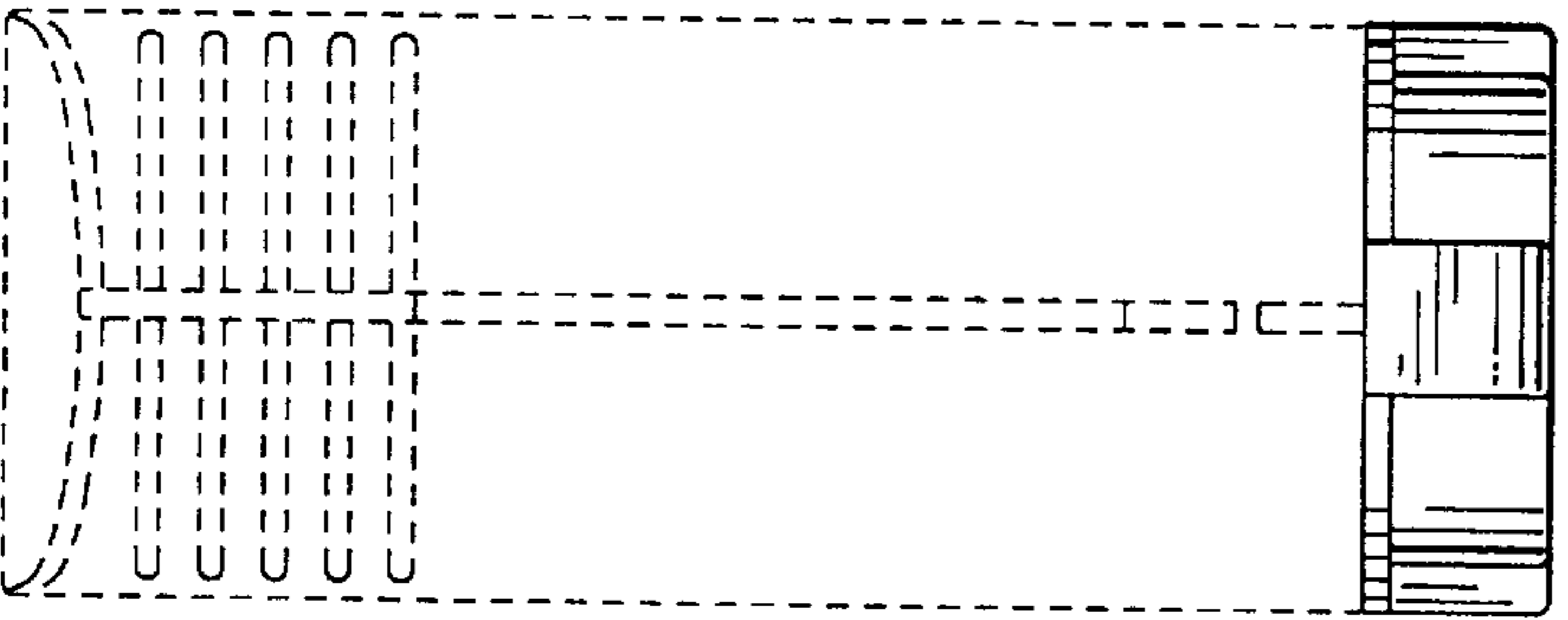

FIG. 24

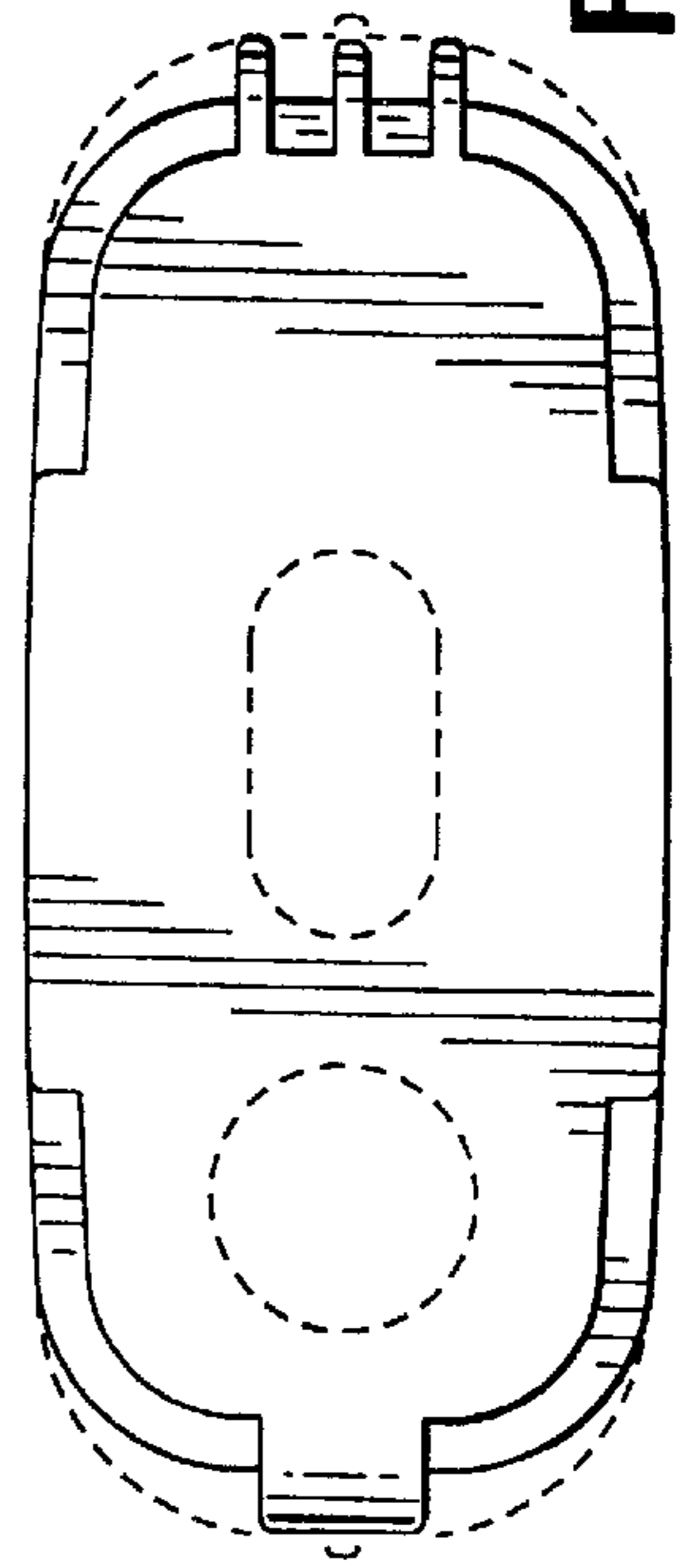

FIG. 26

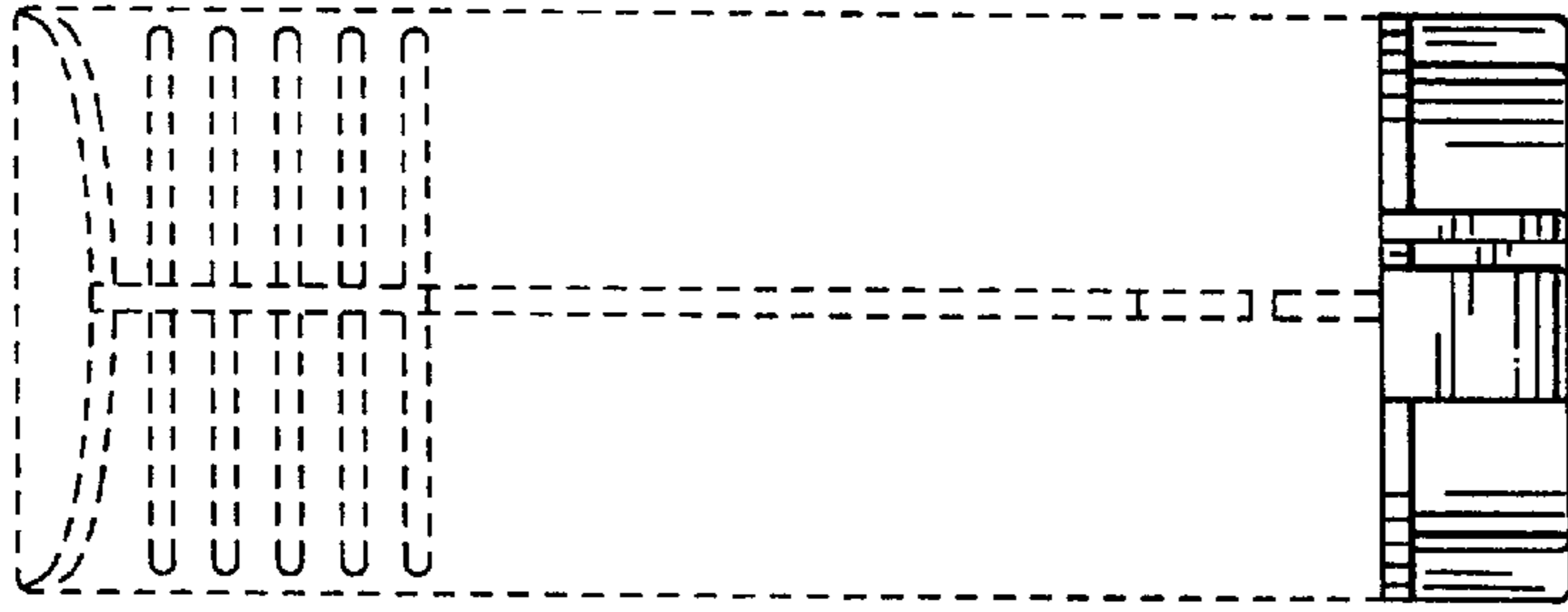

FIG. 27

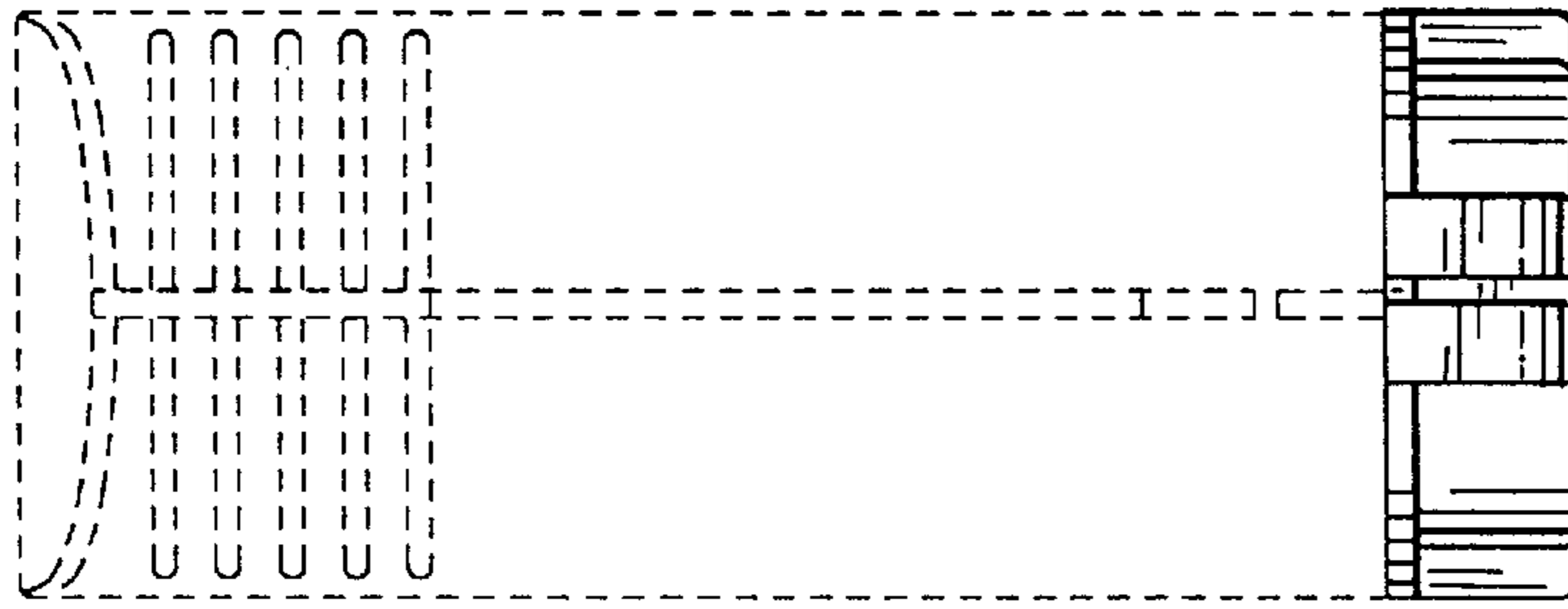

FIG. 28

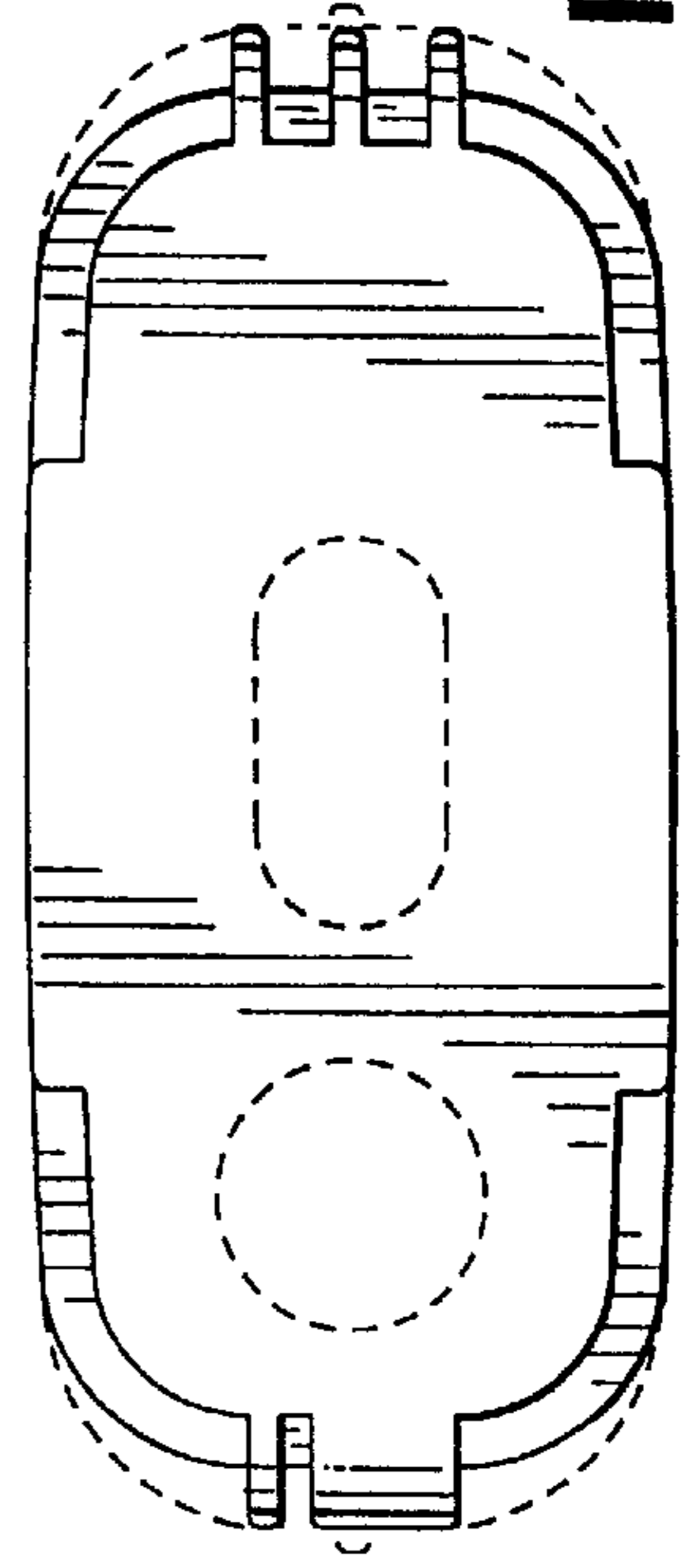

FIG. 29

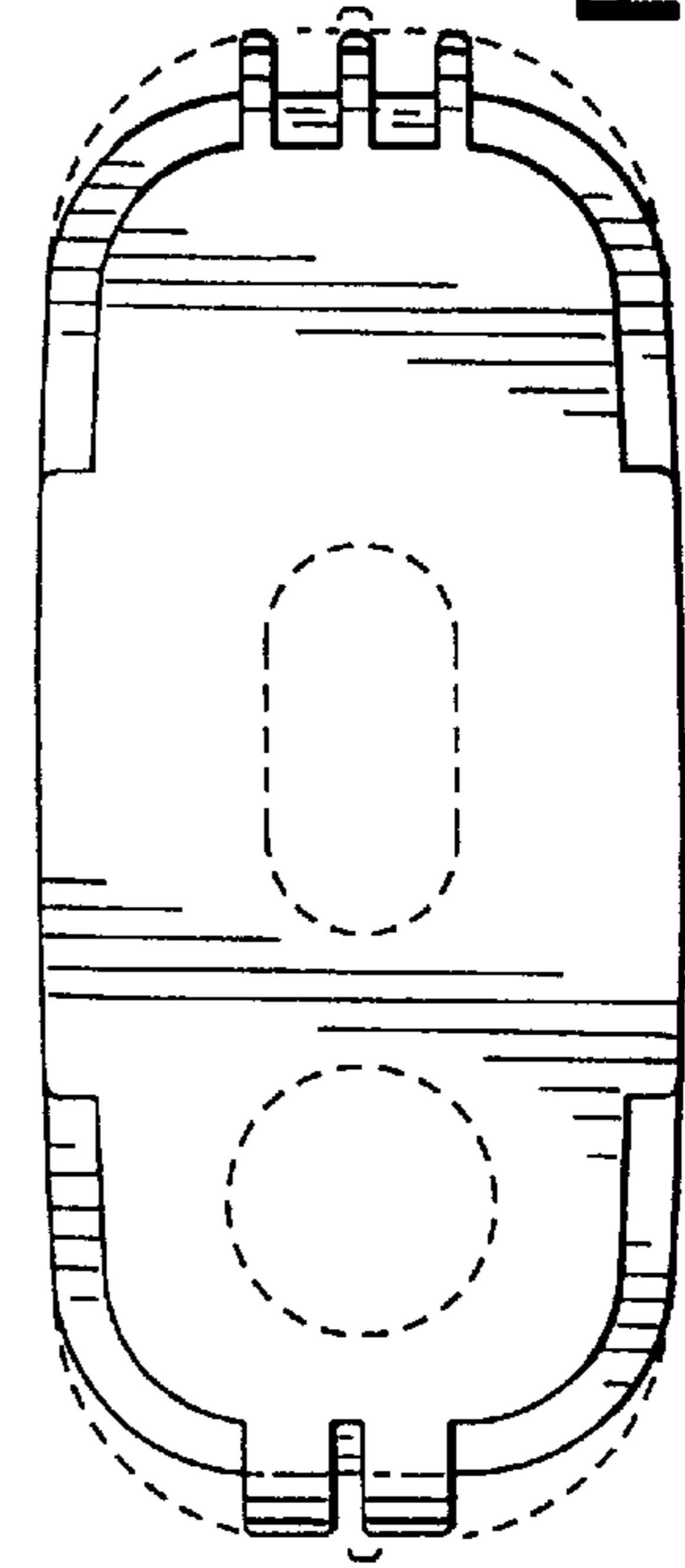

FIG. 30