



US00D428434S

United States Patent [19]
Yasoshima

[11] **Patent Number: Des. 428,434**
[45] **Date of Patent: ** Jul. 18, 2000**

[54] **STAMP PAD WITH ARTICULATED HINGE**

2,117,470 5/1938 Zareko 91/54.5
2,290,488 7/1942 Munson 91/54.5

[75] Inventor: **Rira Yasoshima**, Tokyo, Japan

(List continued on next page.)

[73] Assignee: **Tsukineko, Inc.**, Redmond, Wash.

FOREIGN PATENT DOCUMENTS

[**] Term: **14 Years**

546609 9/1957 Canada .
167 380 A2 1/1996 European Pat. Off. .
2675740 A1 10/1992 France .
662905 6/1938 Germany .
4-312881 11/1992 Japan .
4940 of 1896 United Kingdom .
2045687 11/1980 United Kingdom .

[21] Appl. No.: **29/107,649**

[22] Filed: **Jul. 9, 1999**

[51] **LOC (7) Cl.** **19-03**

[52] **U.S. Cl.** **D18/17**

[58] **Field of Search** D18/14-18; D9/341,
D9/307; D28/76-80, 83, 85, 82; 101/368,
327, 333, 334, 371, 405, 370; 30/120.2;
401/119

OTHER PUBLICATIONS

Clearsnap, Inc., "Art Supplies for Rubber Stamps" Catalog,
pp. 23-26, 1990.
Tsukineko, "Color Palette" Pigment Stamp Pad Catalog
(Japanese), 2 pages.
Tsukineko, Japanese Catalog, 6 pages, 1993.

[56] **References Cited**

(List continued on next page.)

U.S. PATENT DOCUMENTS

D. 184,720 3/1959 Fleming D58/12
D. 247,063 1/1978 Funahashi D64/10
D. 252,935 9/1979 Henkels D19/77
D. 331,418 12/1992 Winston D18/15
D. 345,826 4/1994 Byars et al. D28/83
D. 347,089 5/1994 Byars et al. D28/83
D. 353,392 12/1994 Winston D18/15
D. 363,303 10/1995 Winston D18/18
D. 367,291 2/1996 Winston D18/17
D. 369,384 4/1996 Yasoshima D19/36
D. 372,731 8/1996 Yasoshima D18/17
D. 372,933 8/1996 Winston D18/17
D. 375,516 11/1996 Winston D18/17
D. 381,038 7/1997 Yasoshima D18/17
D. 381,357 7/1997 Yasoshima D18/17
D. 382,581 8/1997 Yasoshima D18/17
D. 386,200 11/1997 Winston D18/17
D. 389,174 1/1998 Yasoshima D18/17
D. 389,509 1/1998 Yasoshima D18/17
D. 400,567 11/1998 Yasoshima D18/17
D. 419,180 1/2000 Yasoshima D18/17
602,061 4/1898 Echelberger .
657,961 9/1900 Roberts .
848,063 3/1907 Sommer .
1,173,092 2/1916 Bickerton .
1,463,718 7/1923 Munson .
1,598,538 8/1926 Mann .
1,796,137 3/1931 Baumgarten .

Primary Examiner—Louis S. Zarfaz
Assistant Examiner—G. Andoll
Attorney, Agent, or Firm—Seed Intellectual Property Law
Group, PLLC

[57] **CLAIM**

The ornamental design for a stamp pad with articulated hinge, as shown and described.

DESCRIPTION

FIG. 1 is a front perspective view of a stamp pad with articulated hinge in accordance with an embodiment of my new design.
FIG. 2 is a front elevational view thereof.
FIG. 3 is top plan view thereof.
FIG. 4 is a bottom plan view thereof.
FIG. 5 is left side elevational view thereof.
FIG. 6 is a right side elevational view thereof; and,
FIG. 7 is a rear elevational view thereof.
The broken lines in the FIGURES are for illustrative purposes only and form no part of the claimed design.

1 Claim, 3 Drawing Sheets

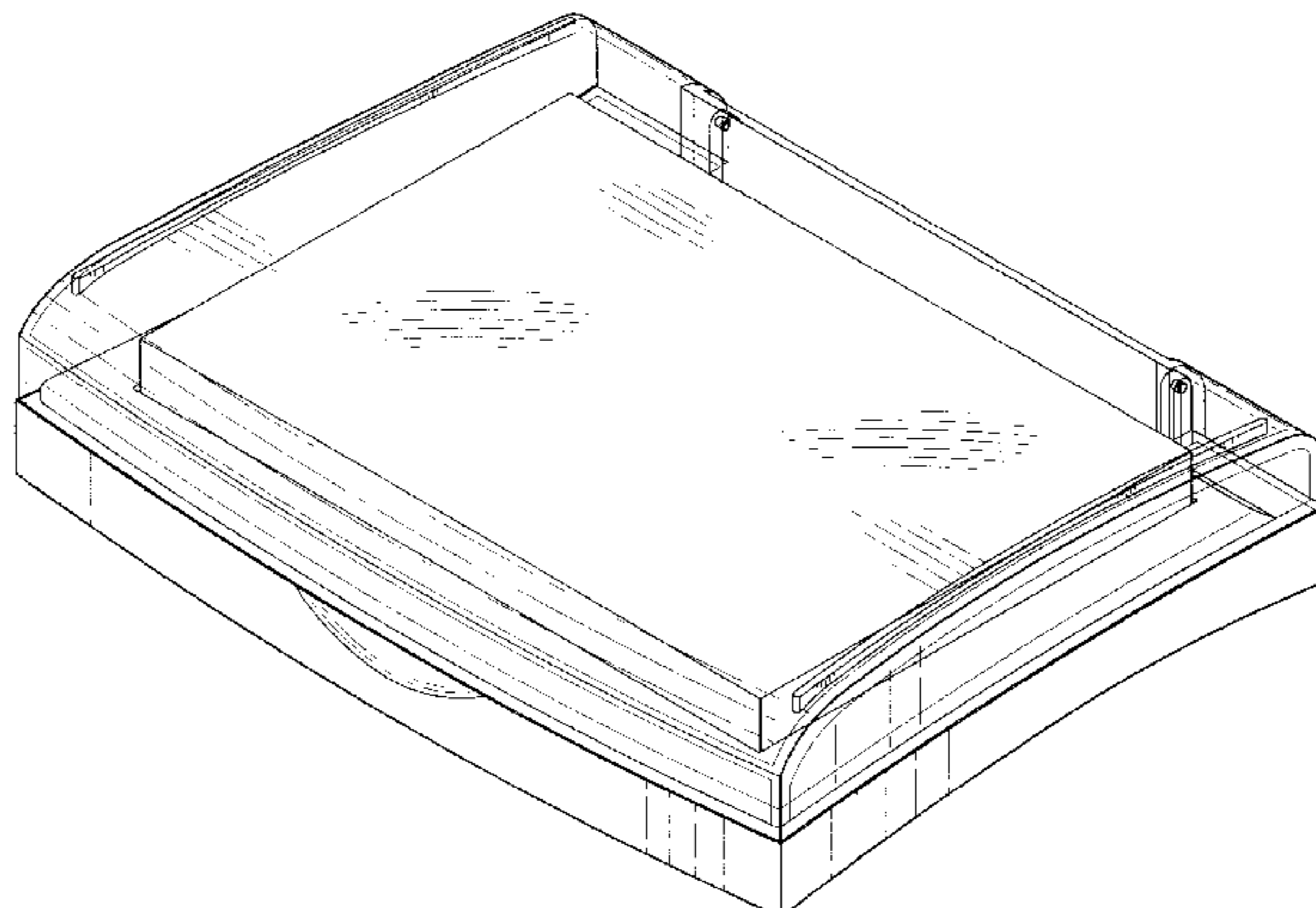

U.S. PATENT DOCUMENTS

2,374,198	4/1945	Harris	91/54.5
2,422,814	6/1947	ALexander	91/54.5
2,723,476	11/1955	Lyon	41/1
3,326,180	6/1967	Lofgren	118/264
3,590,734	7/1971	Carter	101/333
3,797,390	3/1974	Marozzi et al.	101/333
4,029,011	6/1977	Kurner	101/330
4,145,967	3/1979	Marozzi	101/333
4,986,175	1/1991	Boehringer et al.	101/125
5,431,098	7/1995	Winston	101/211
5,462,595	10/1995	Im	118/264
5,505,130	4/1996	Winston	101/333
5,531,829	7/1996	Yasoshima	118/264
5,601,644	2/1997	Yasoshima	118/46
5,636,569	6/1997	Winston	101/333
5,653,804	8/1997	Yasoshima	118/46
5,865,305	2/1999	Yasoshima	206/1.7
5,865,892	2/1999	Yasoshima	118/264

OTHER PUBLICATIONS

Clearsnap, Inc., "Color Box Pigment Stamp Pads" (See circled stamp pad, top left), 1 page, 1993.
Ink-A-Dink-A-Do, "4 Inks in One" Stamp Pad (facsimile), 3 pages.
Clearsnap, Inc., "Define: ColorBox," 1 page, 1995.
Tsukineko, "The Possibilities Are Endless" Catalog, 6 pages, May 1995.
Tsukineko, "Rubber Stamp/Ink Pad" 1996/97 Catalog, pp. 1-8.
Stencil & Hobby Catalog (Japanese), 3 pages, 1999.
U.S. application No. 09/342,685, Yasoshima, filed Jul. 1, 1999, pending.
U.S. application No. 29/107,388, Yasoshima, filed Jul. 2, 1999, allowed.
U.S. application No. 09/337,305, Yasoshima, filed Aug., 31, 1999, pending.

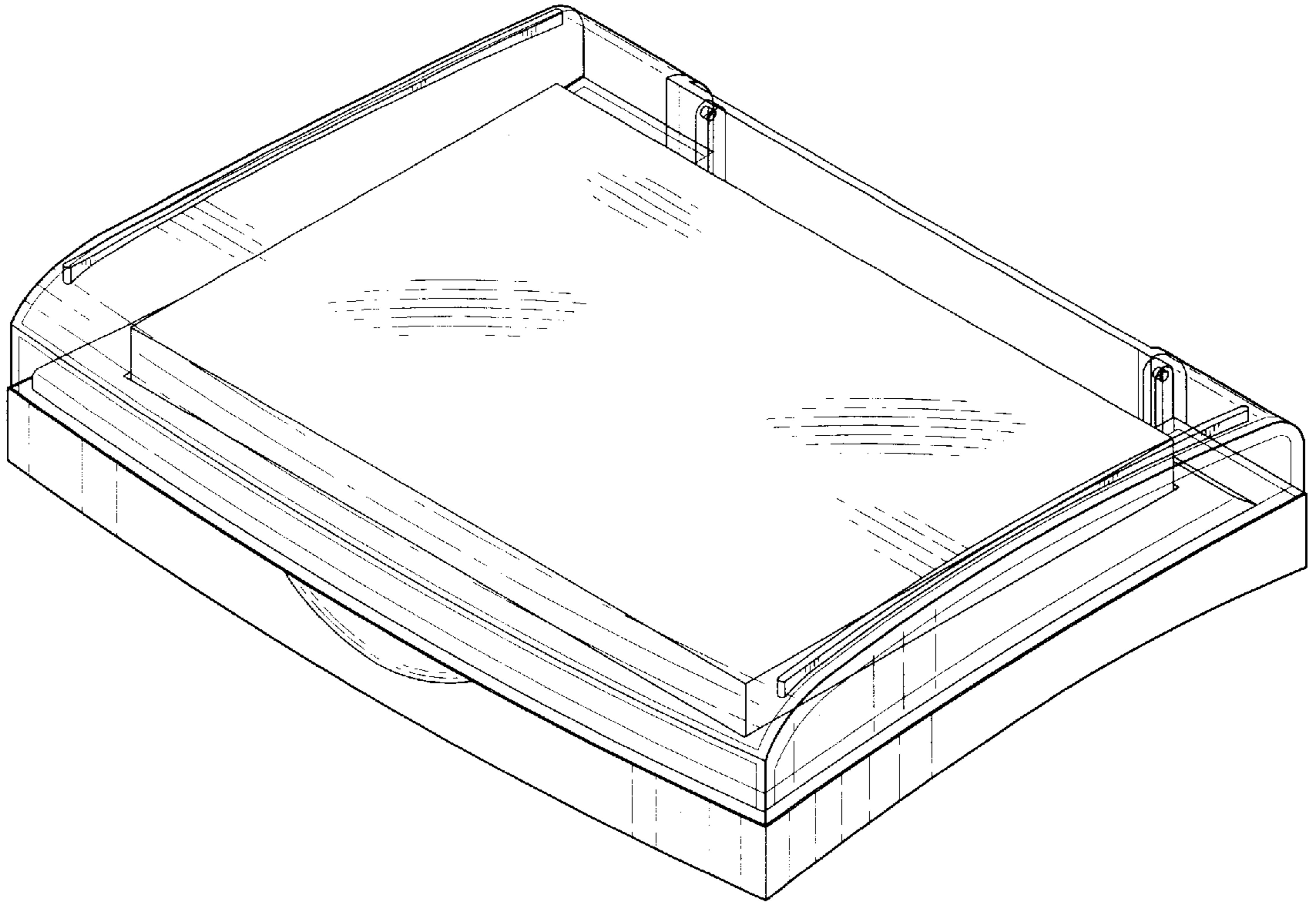

Fig. 1

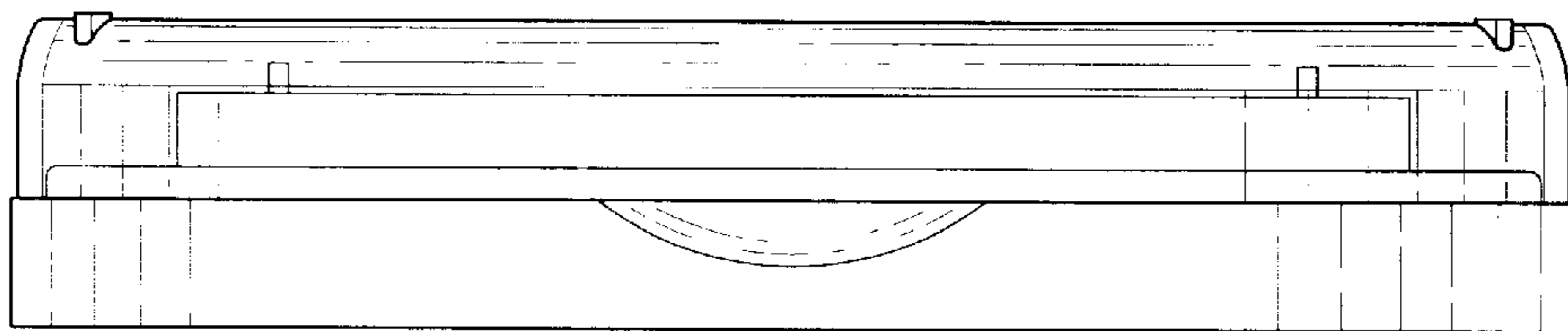

Fig. 2

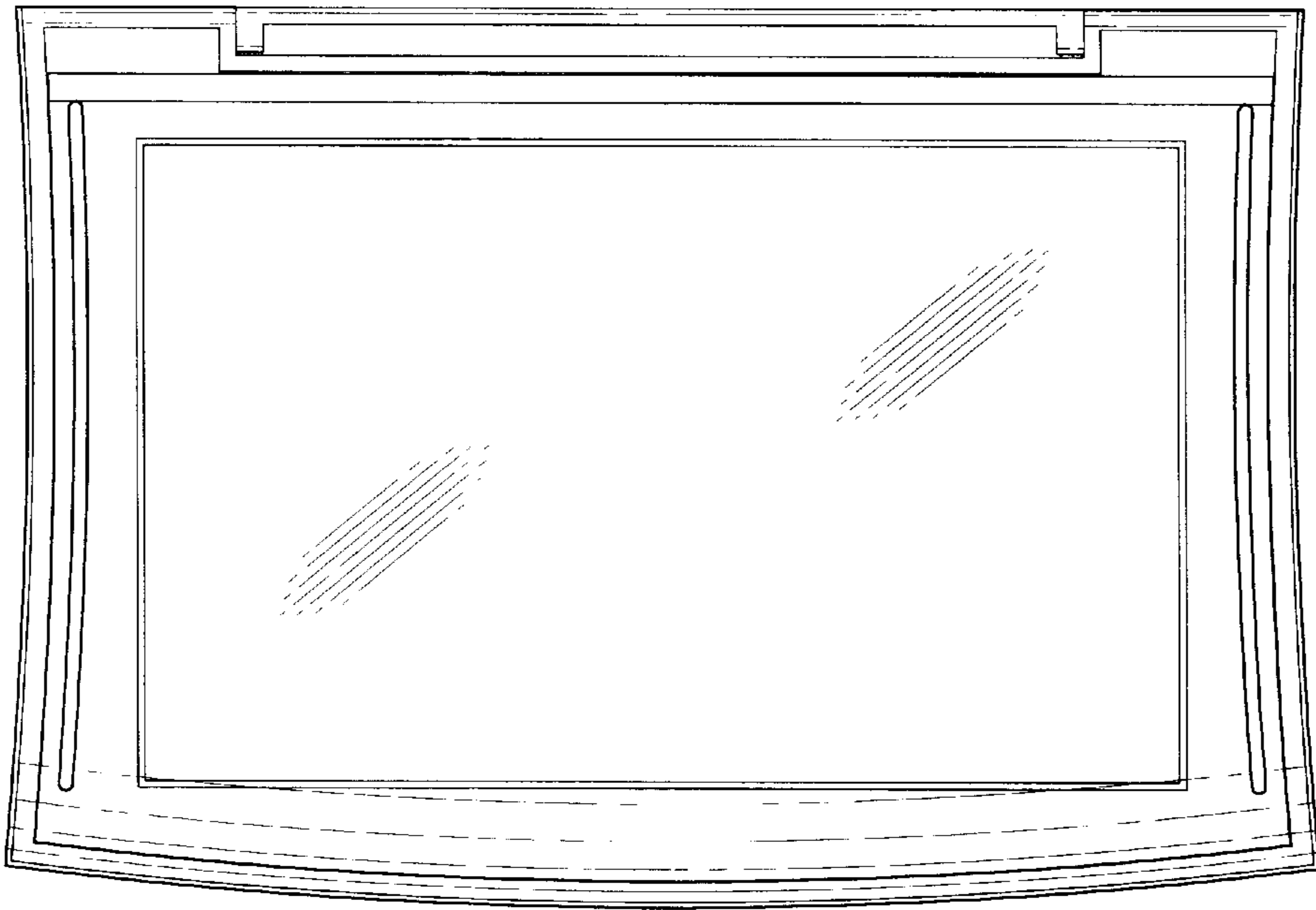

Fig. 3

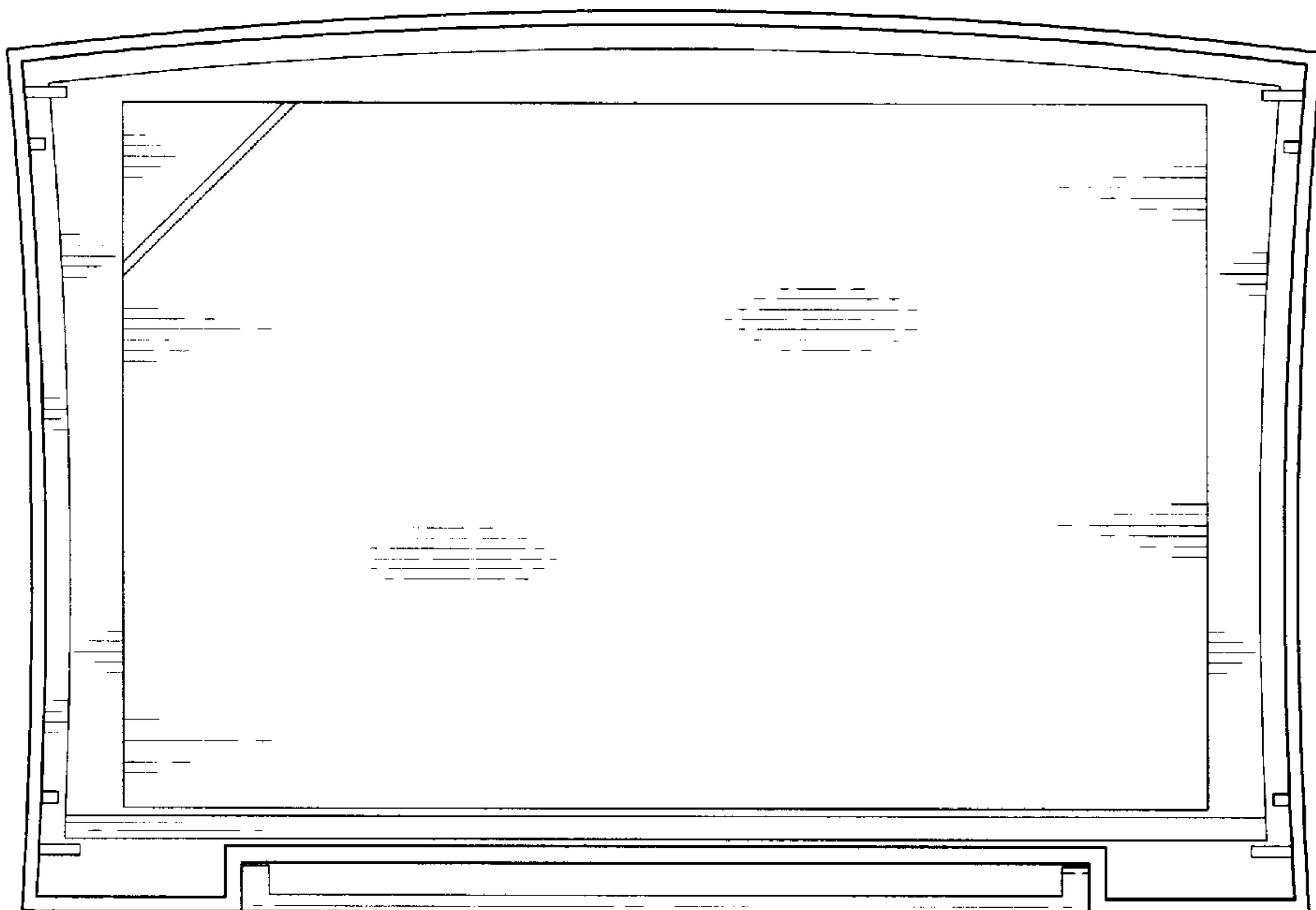

Fig. 4

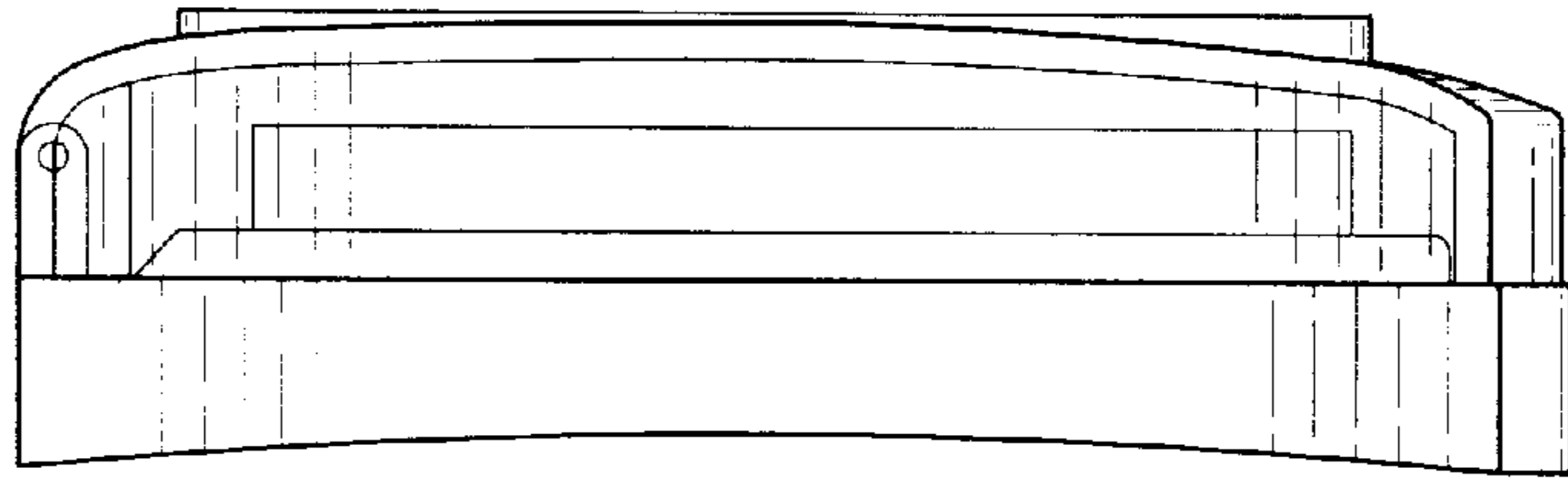

Fig. 5

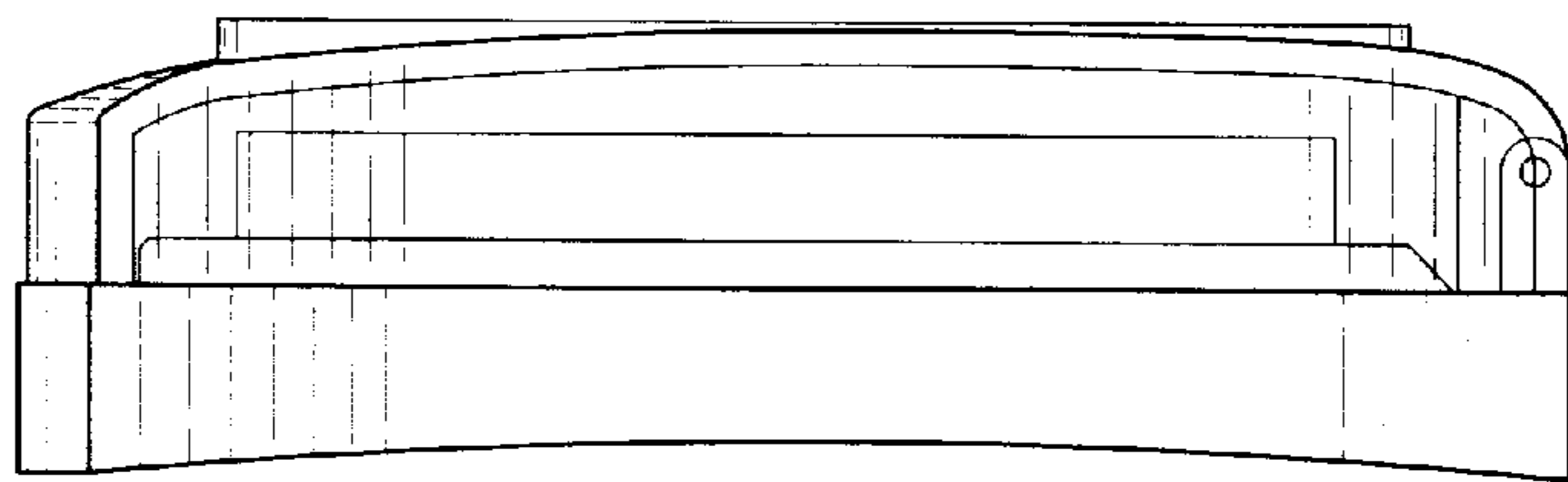

Fig. 6

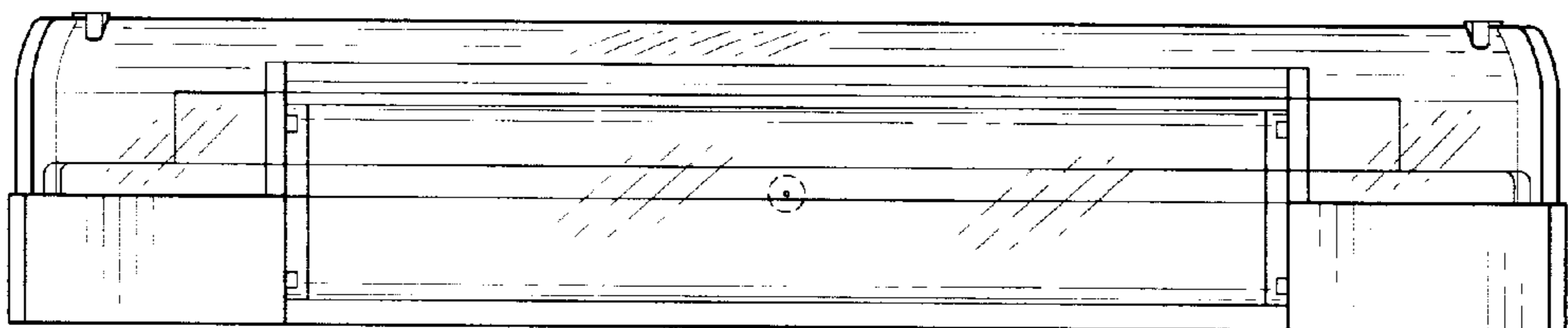

Fig. 7