



US00D428433S

United States Patent [19] Ho

[11] **Patent Number: Des. 428,433**

[45] **Date of Patent: ** Jul. 18, 2000**

[54] **TOY COMMUNICATOR**

D. 409,196 5/1999 Wicks D14/191

[75] Inventor: **Yiu-Ming Kenneth Ho**, Park Yuen Long N.T., The Hong Kong Special Administrative Region of the People's Republic of China

Primary Examiner—Raphael Barkai
Attorney, Agent, or Firm—Kennedy Covington Lobdell & Hickman

[73] Assignee: **Ying Leung International Ltd.**, Hong Kong, The Hong Kong Special Administrative Region of the People's Republic of China

[57] **CLAIM**

The ornamental design for toy communicator, as shown and described.

[**] Term: **14 Years**

DESCRIPTION

[21] Appl. No.: **29/103,750**

FIG. 1 is a front perspective view of a toy communicator, showing one embodiment according to my new design; FIG. 2 is a rear perspective view thereof; FIG. 3 is a front elevational view thereof; FIG. 4 is a rear elevational view thereof; FIG. 5 is a top plan view thereof; FIG. 6 is a bottom plan view thereof; FIG. 7 is a left end elevational view thereof; FIG. 8 is a right end elevational view thereof; FIG. 9 is another front perspective view of a toy communicator, showing a second embodiment of my new design; FIG. 10 is a rear perspective view thereof; FIG. 11 is a front elevational view thereof; FIG. 12 is a rear elevational view thereof; FIG. 13 is a top plan view thereof; FIG. 14 is a bottom plan view thereof; FIG. 15 is a left end elevational view thereof; and, FIG. 16 is a right end elevational view thereof.

[22] Filed: **Apr. 21, 1999**

[51] **LOC (7) Cl.** **21-01**

[52] **U.S. Cl.** **D16/513; D14/191**

[58] **Field of Search** D21/513, 517, D21/324, 329, 531; D14/191, 138; 446/141, 297

[56] **References Cited**

U.S. PATENT DOCUMENTS

D. 260,411	8/1981	Rubin	D21/513
D. 353,594	12/1994	Kawano et al.	D14/191
D. 368,432	4/1996	Takashi	D14/191
D. 390,230	2/1998	Wolf et al.	D14/191
D. 401,239	11/1998	Delong	D14/191

1 Claim, 11 Drawing Sheets

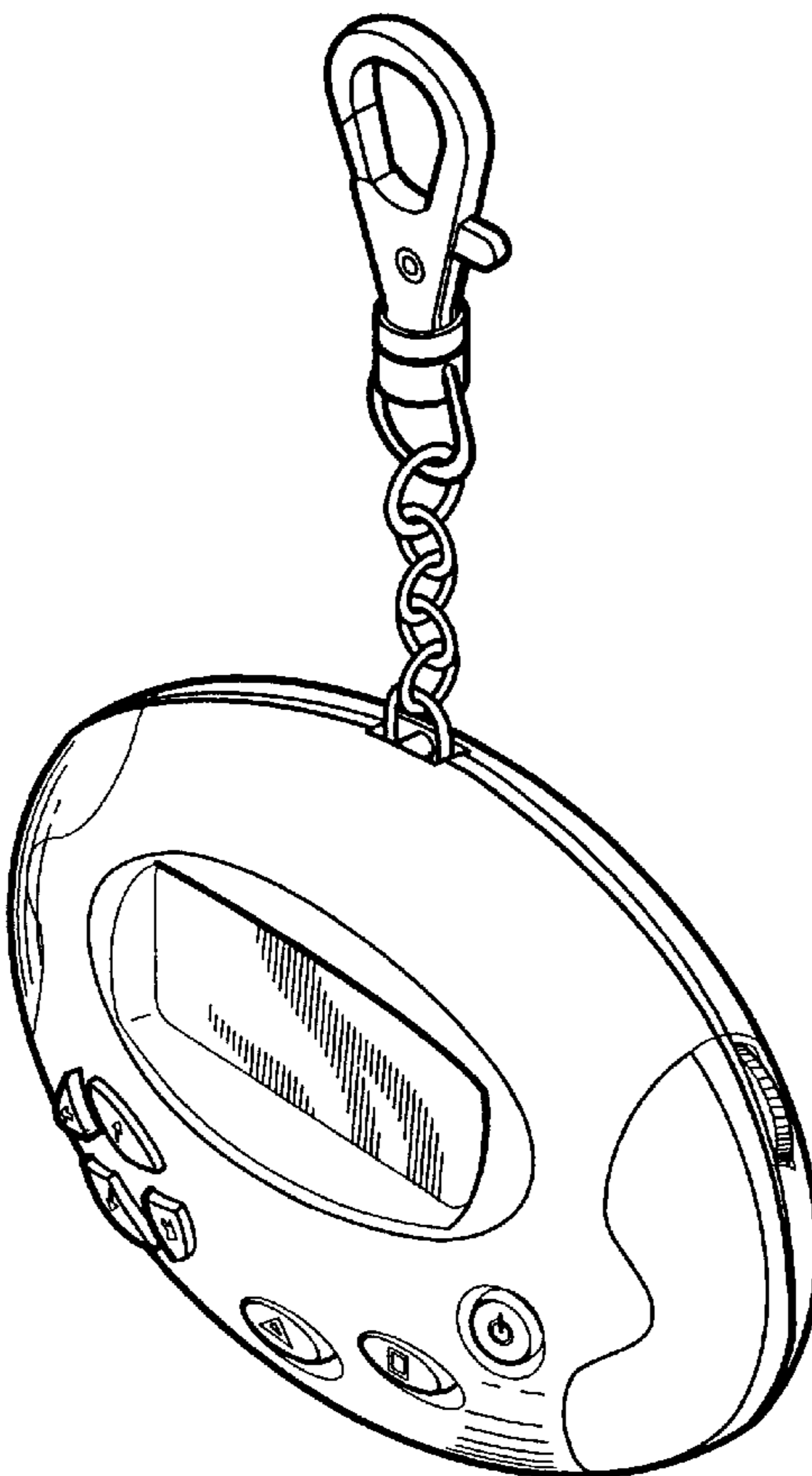

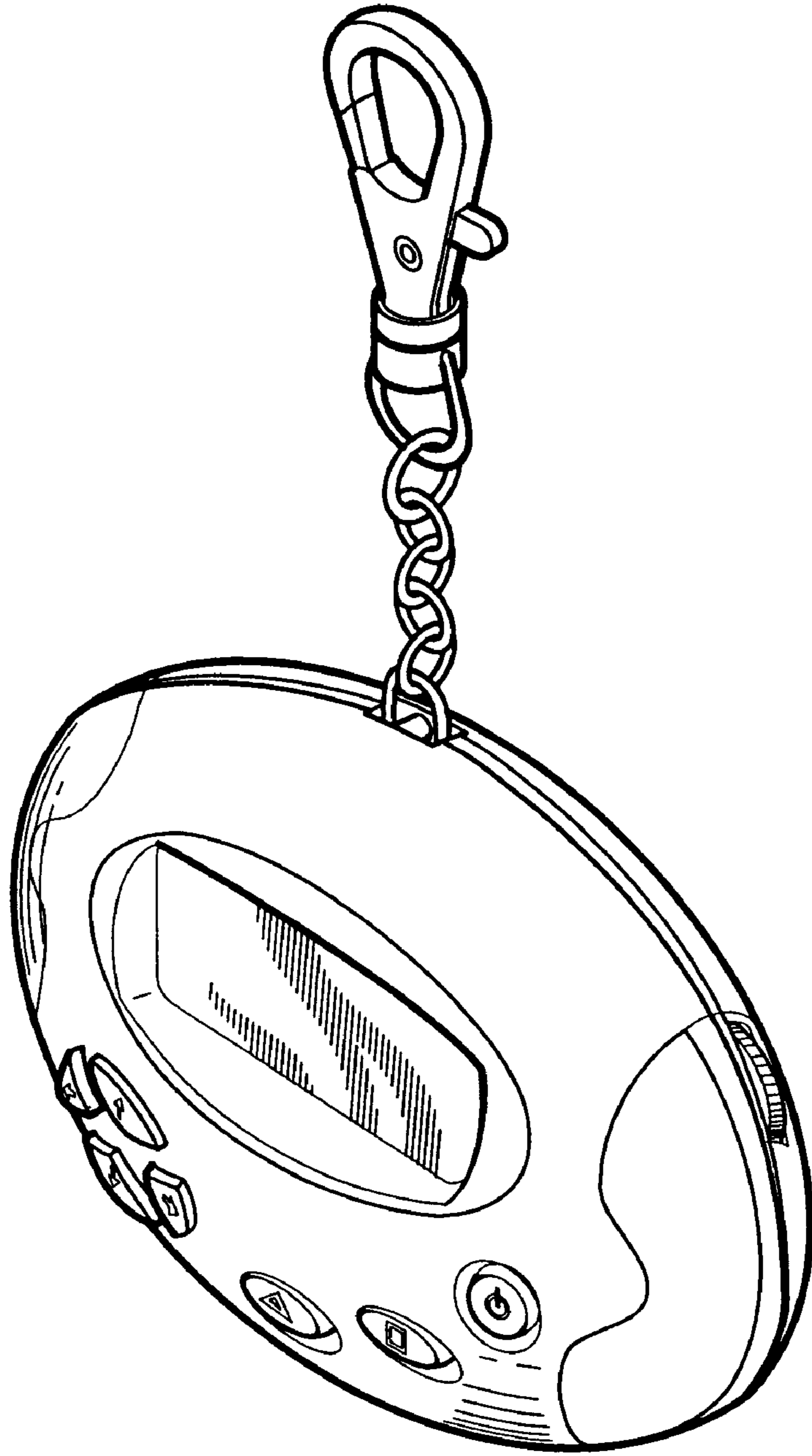

Fig. 1

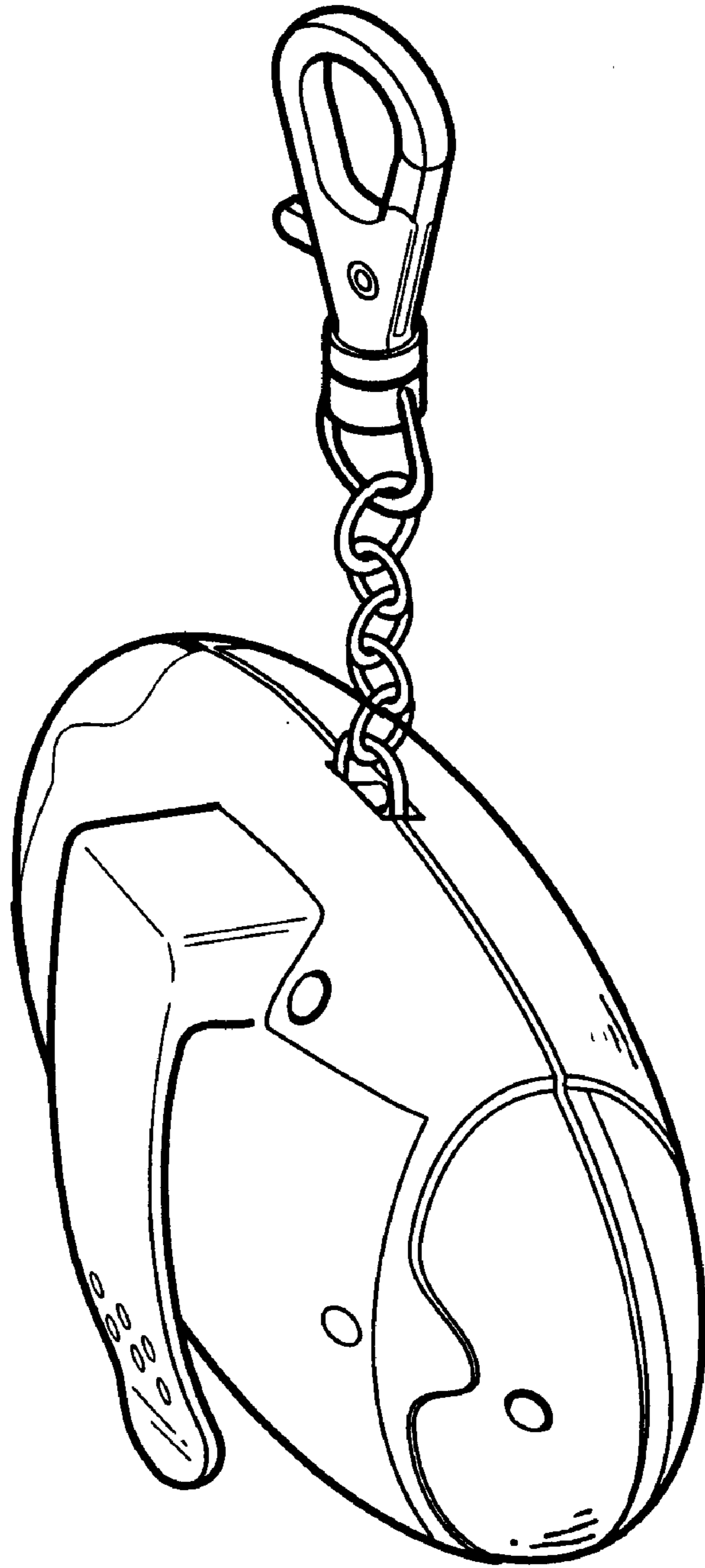

Fig. 2

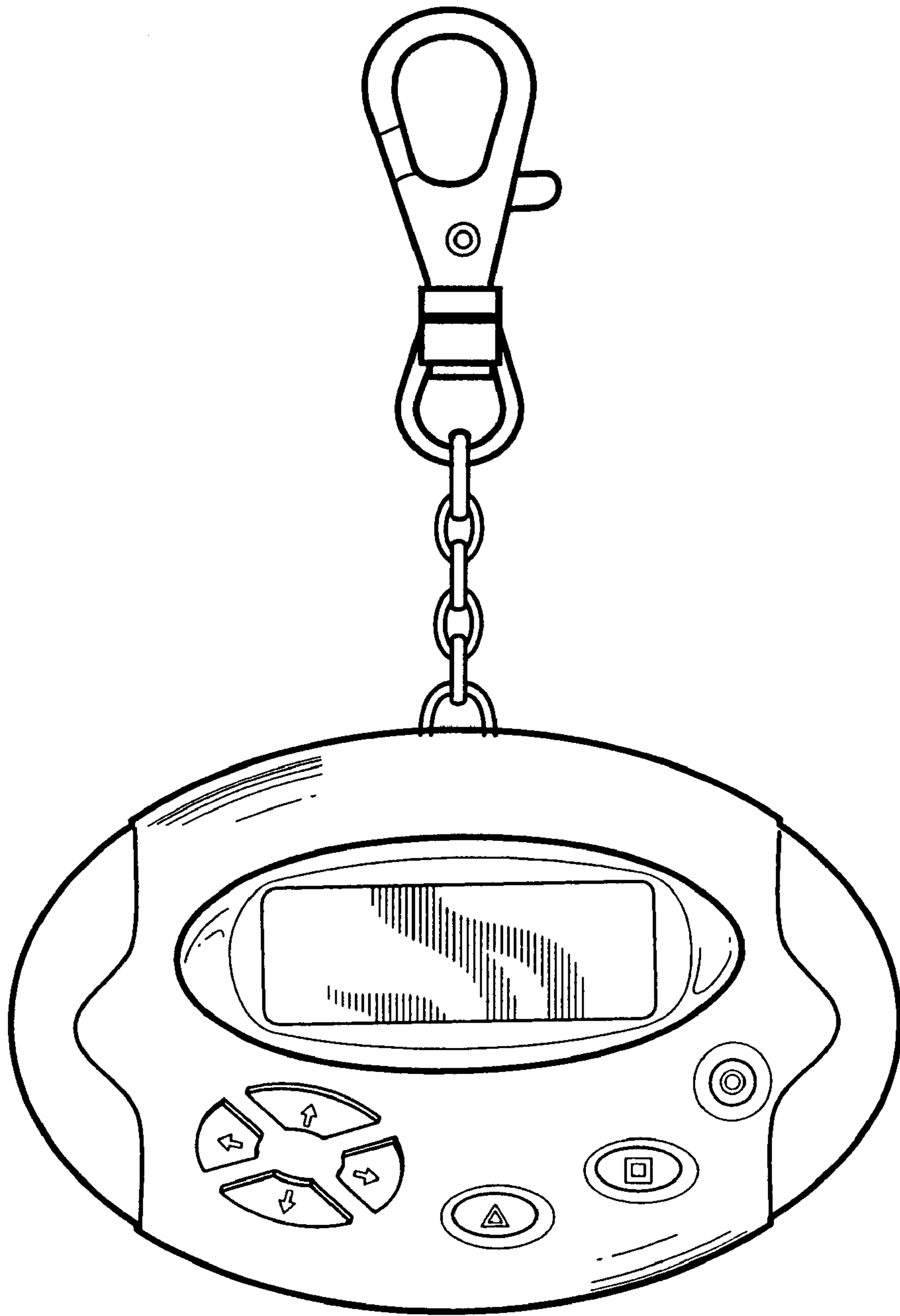

Fig. 3

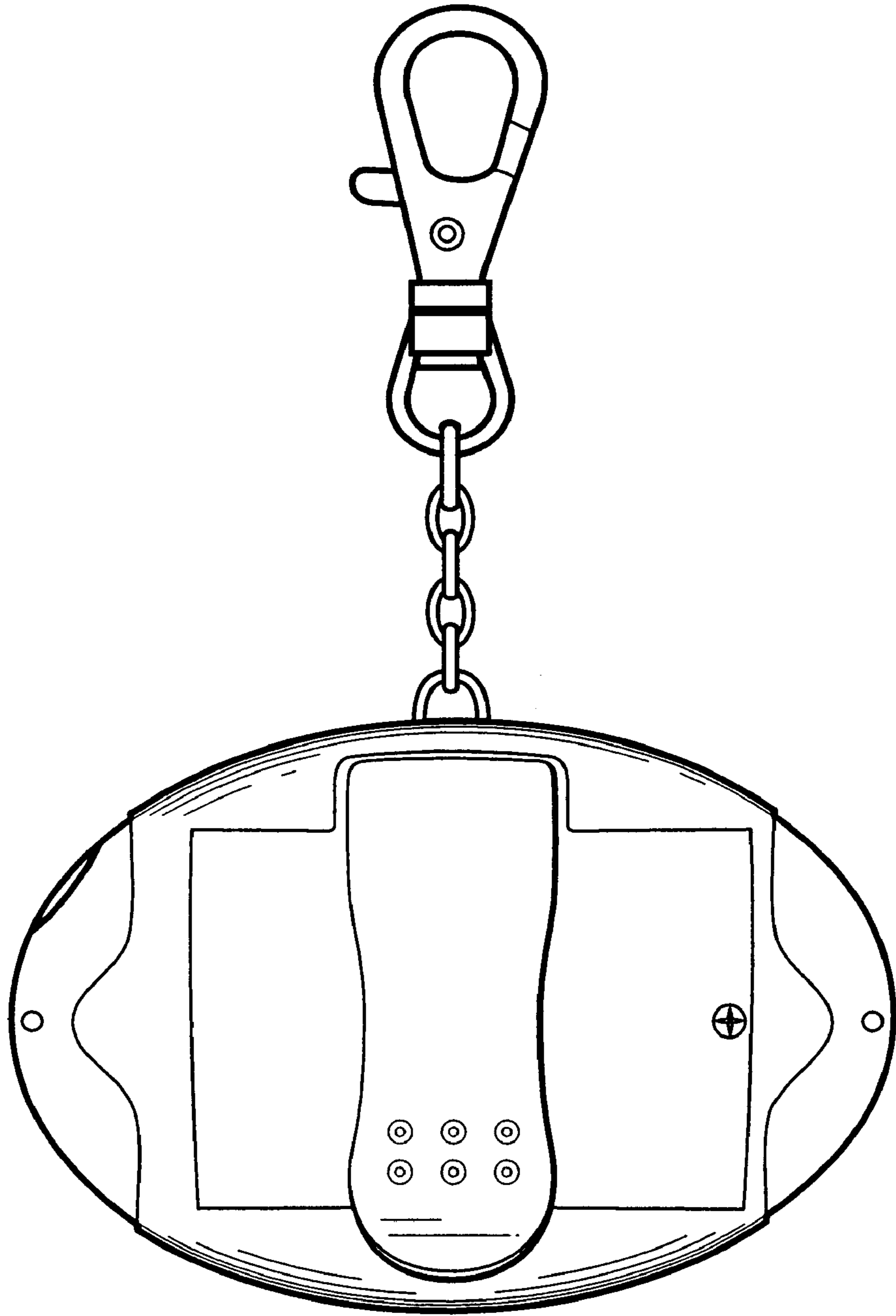

Fig. 4

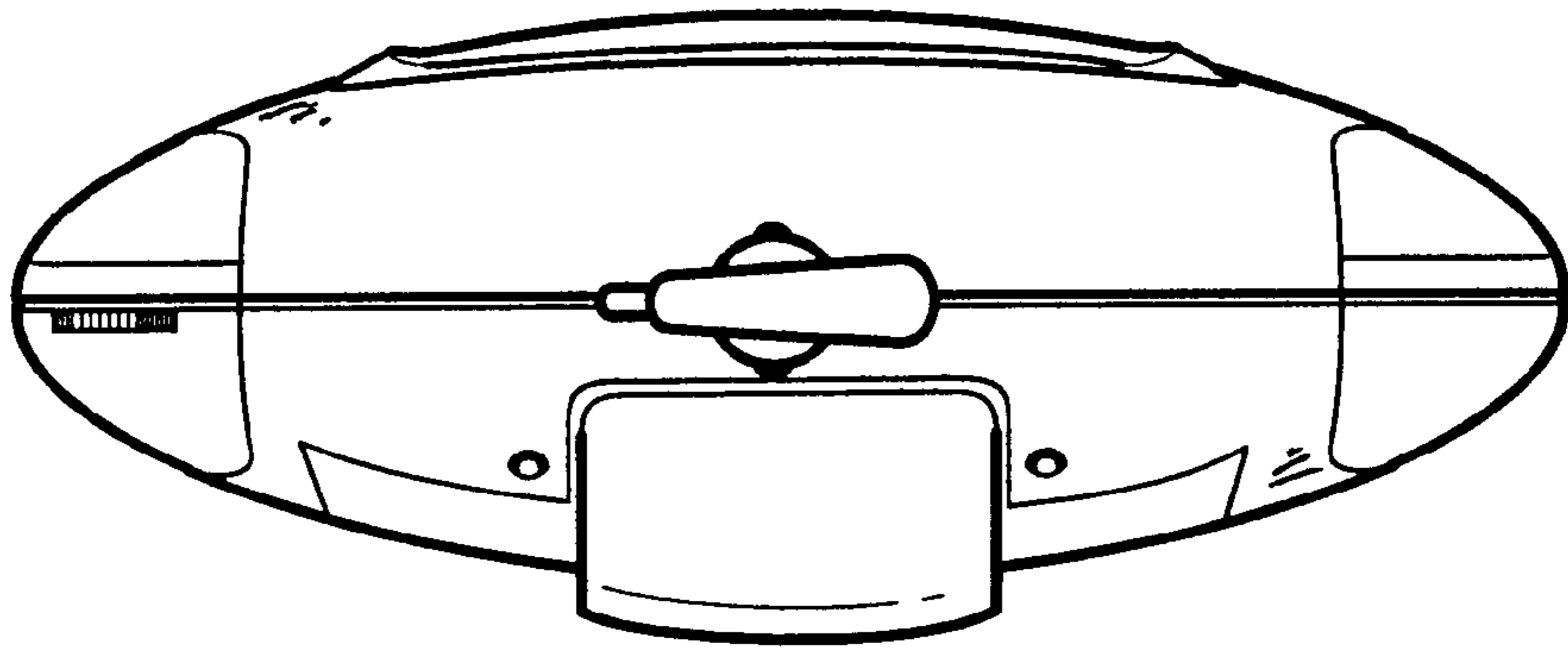

Fig. 5

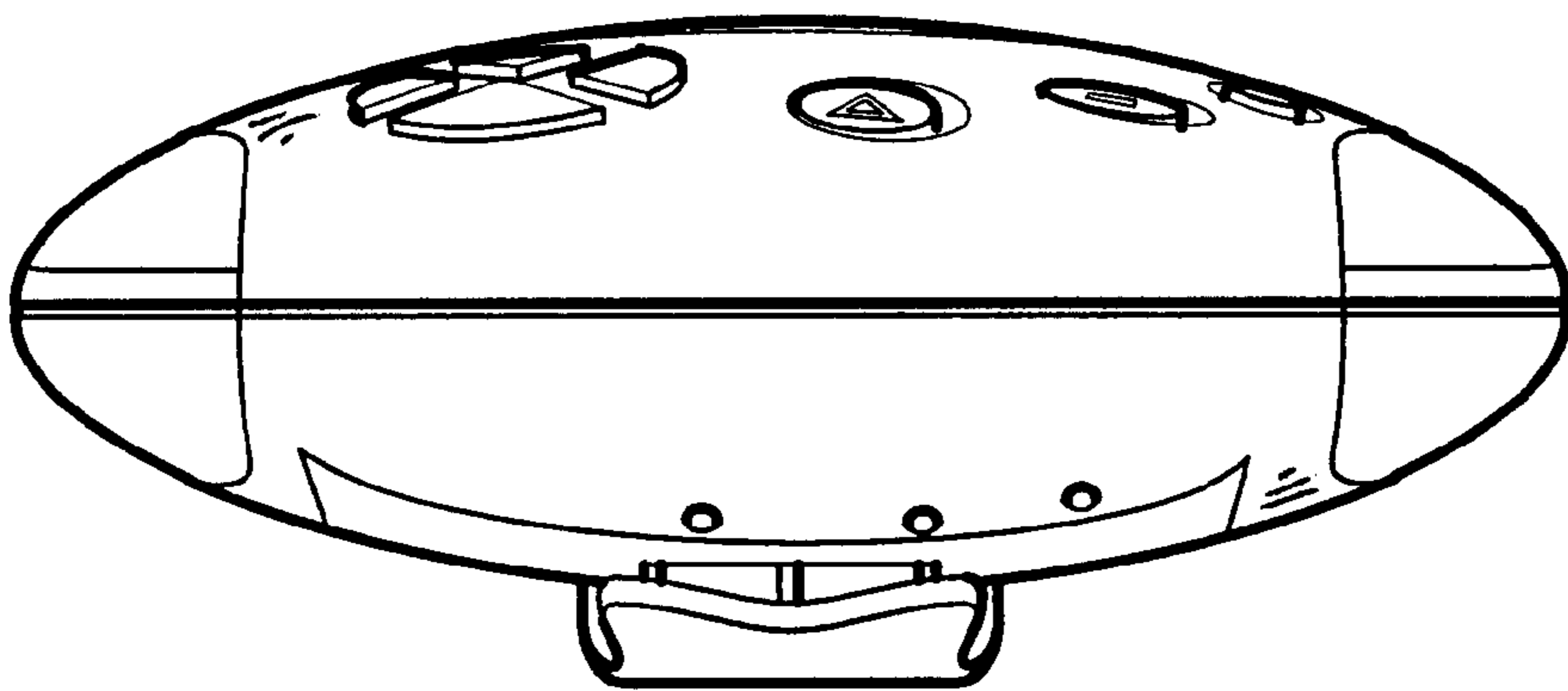

Fig. 6

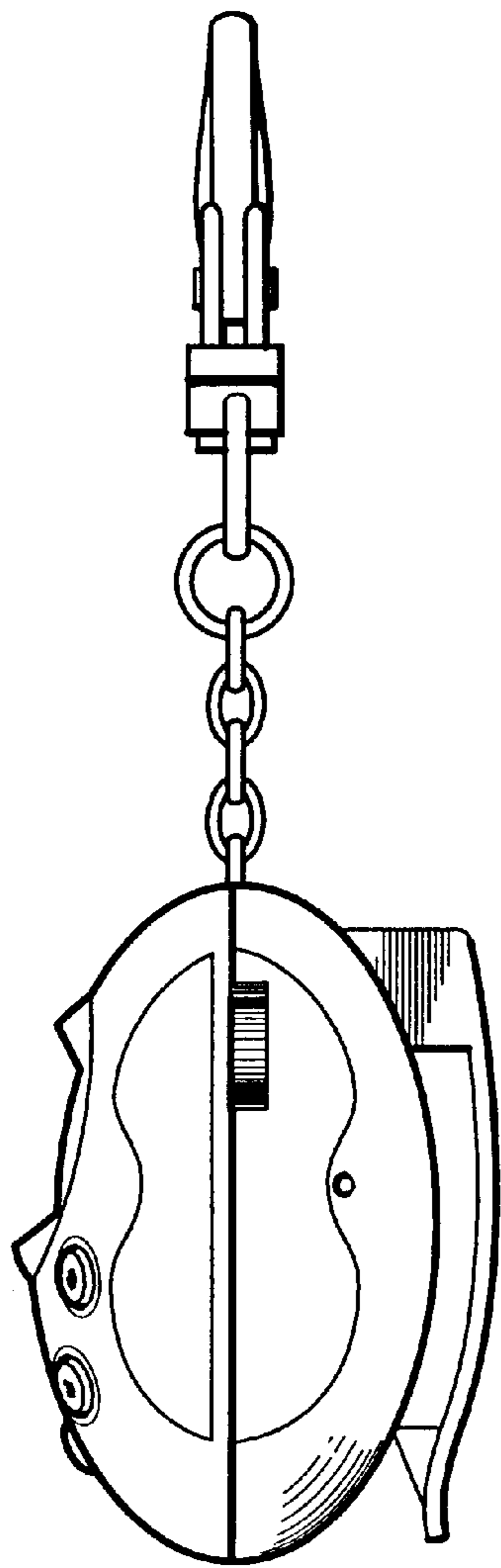

Fig. 7

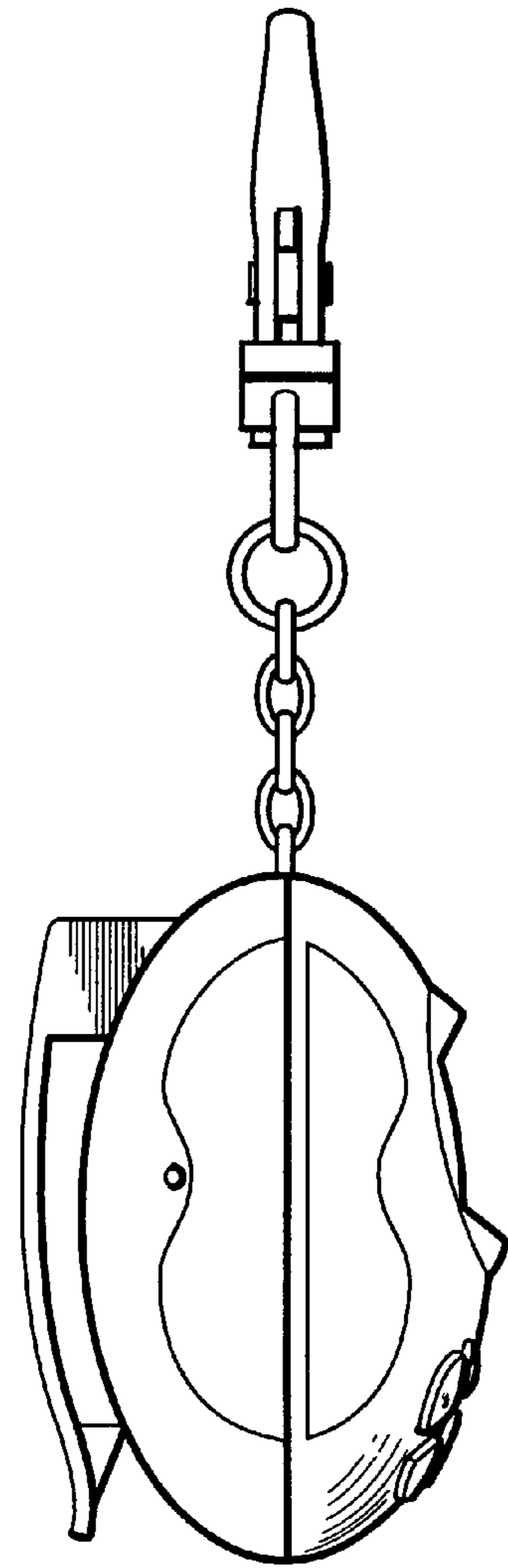

Fig. 8

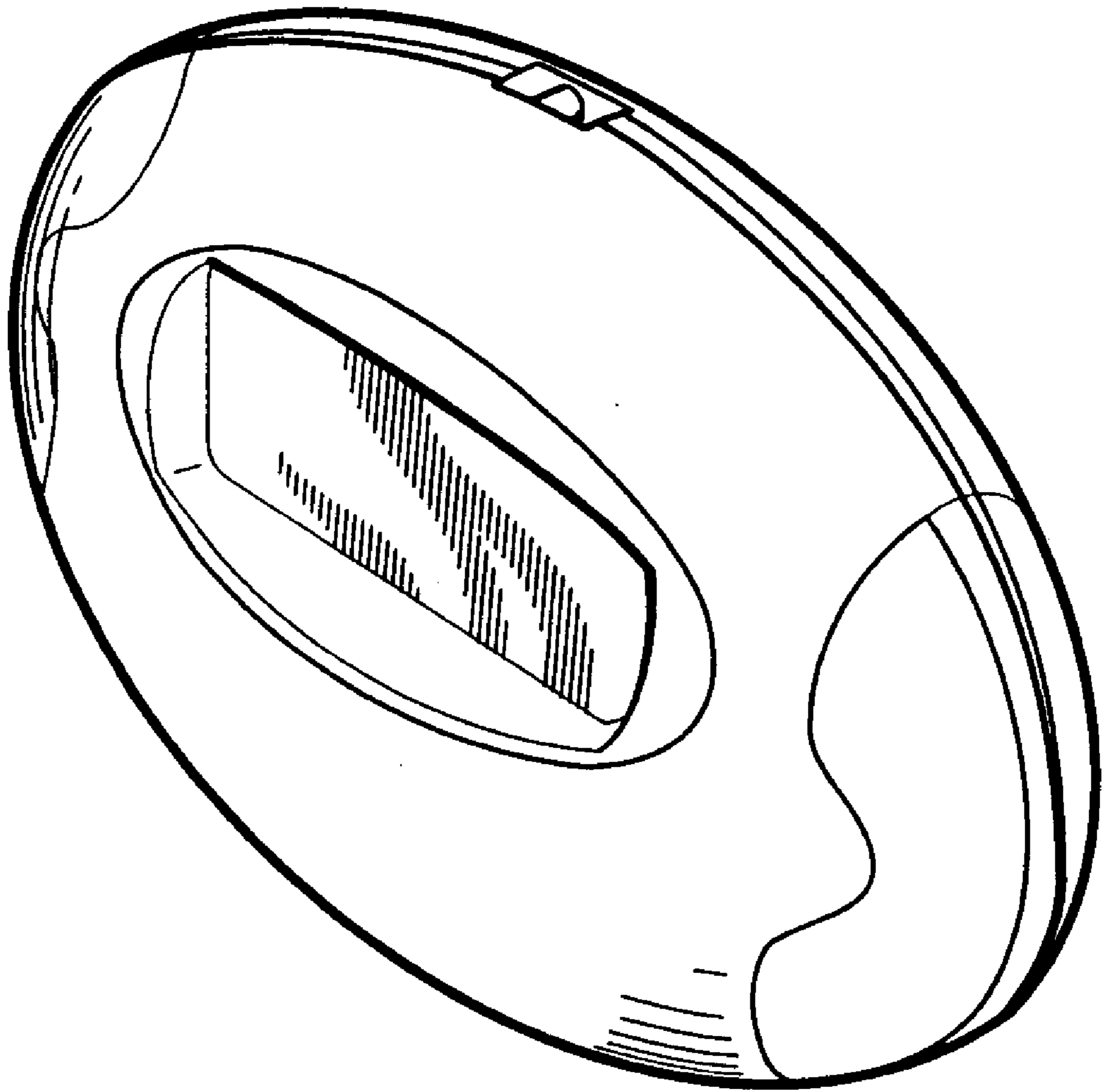

Fig. 9



Fig. 10

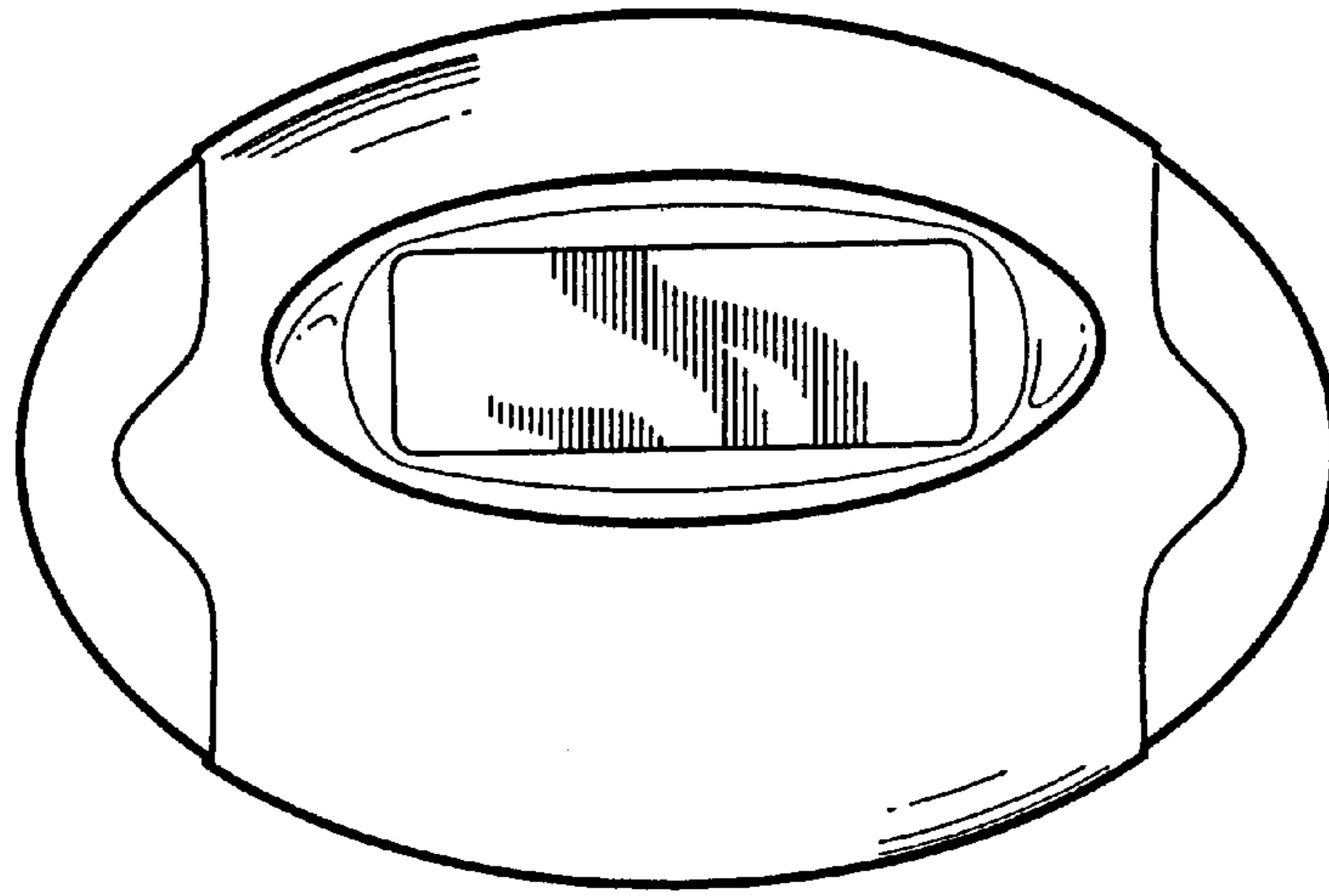

Fig. 11

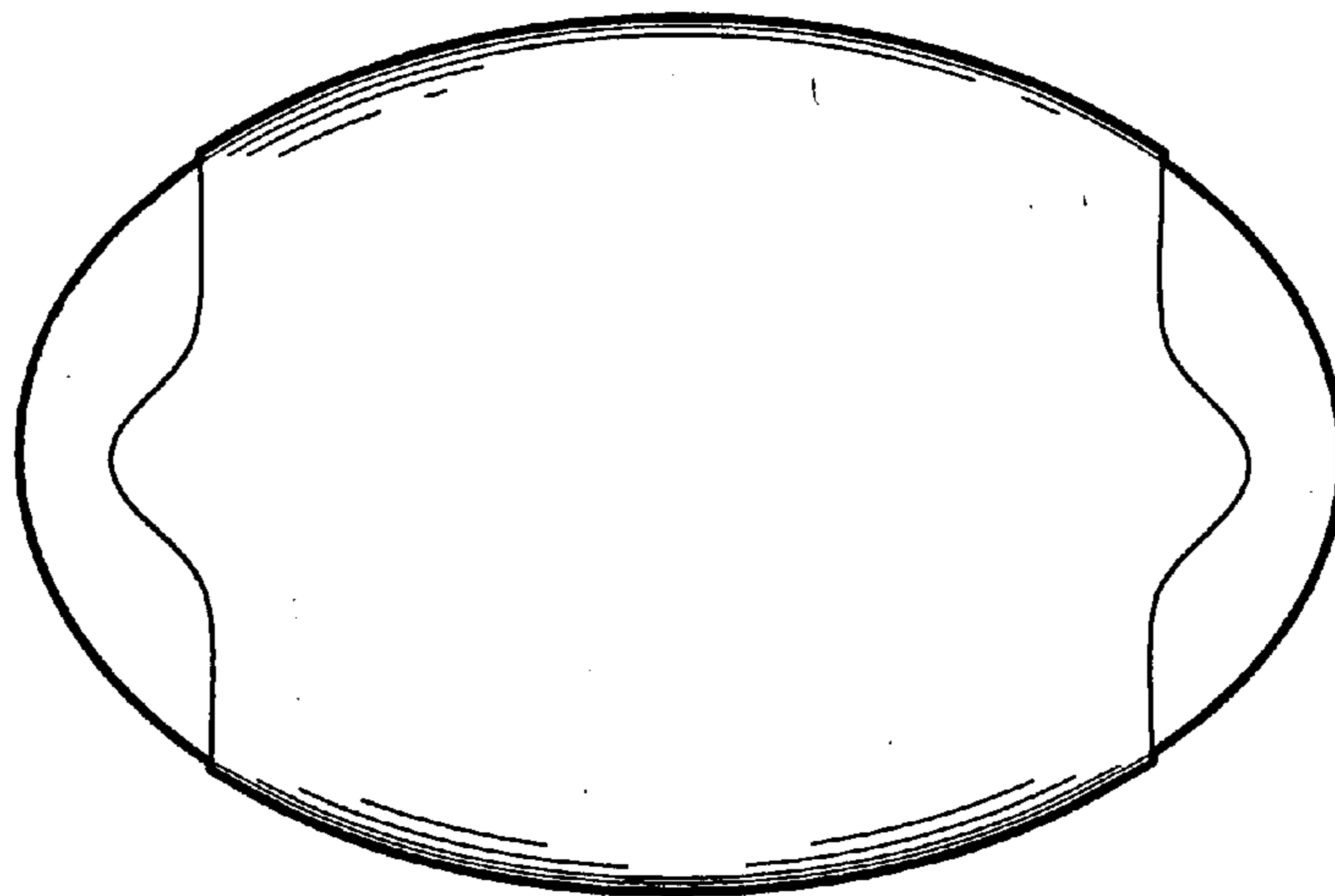

Fig. 12

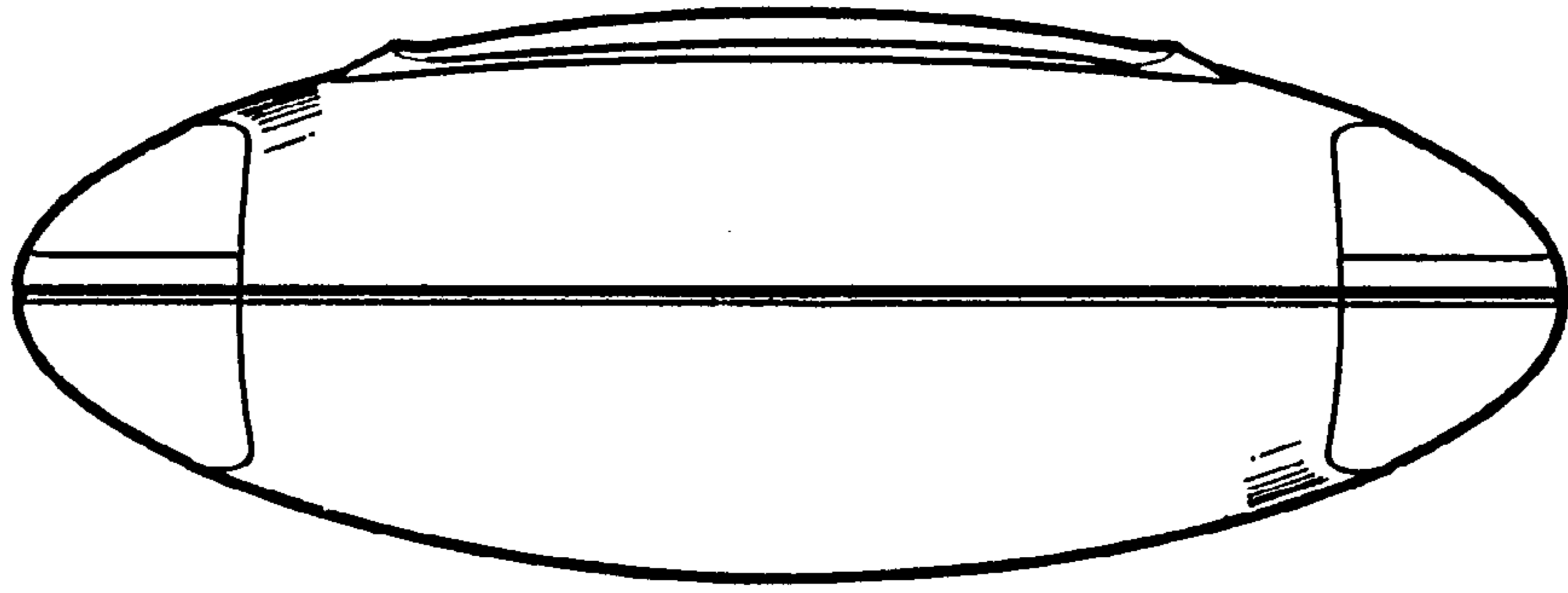

Fig. 13

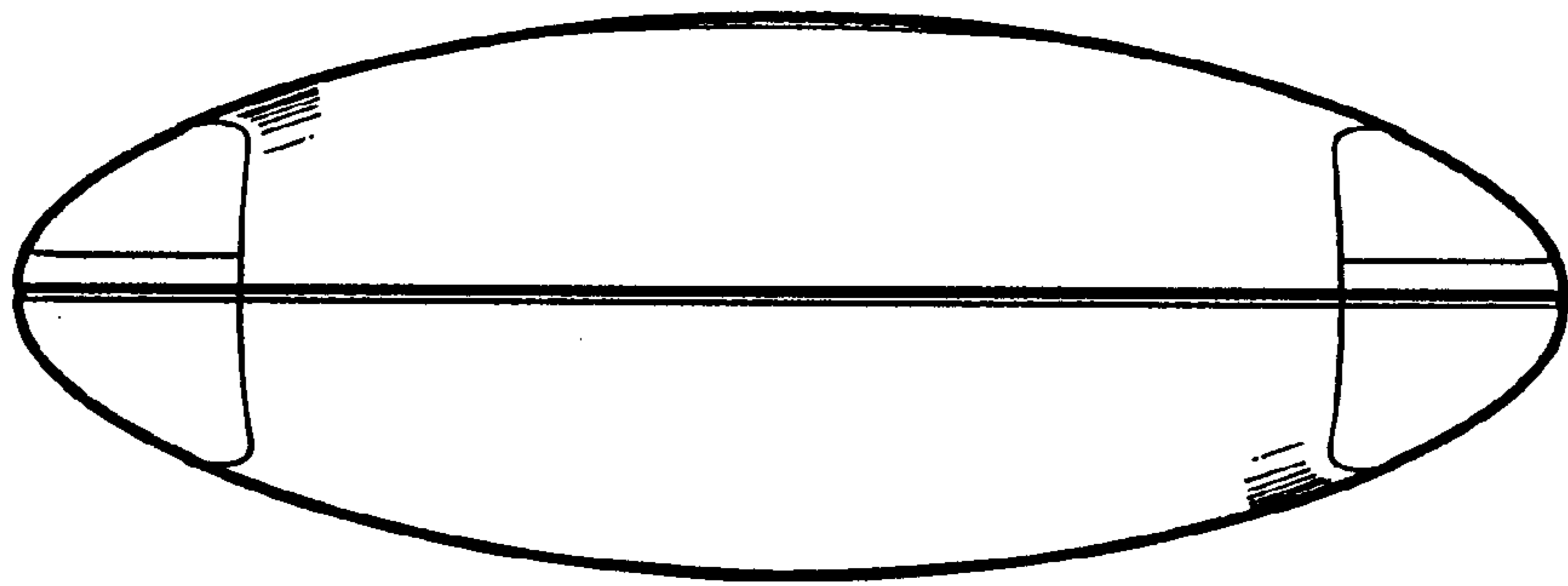

Fig. 14

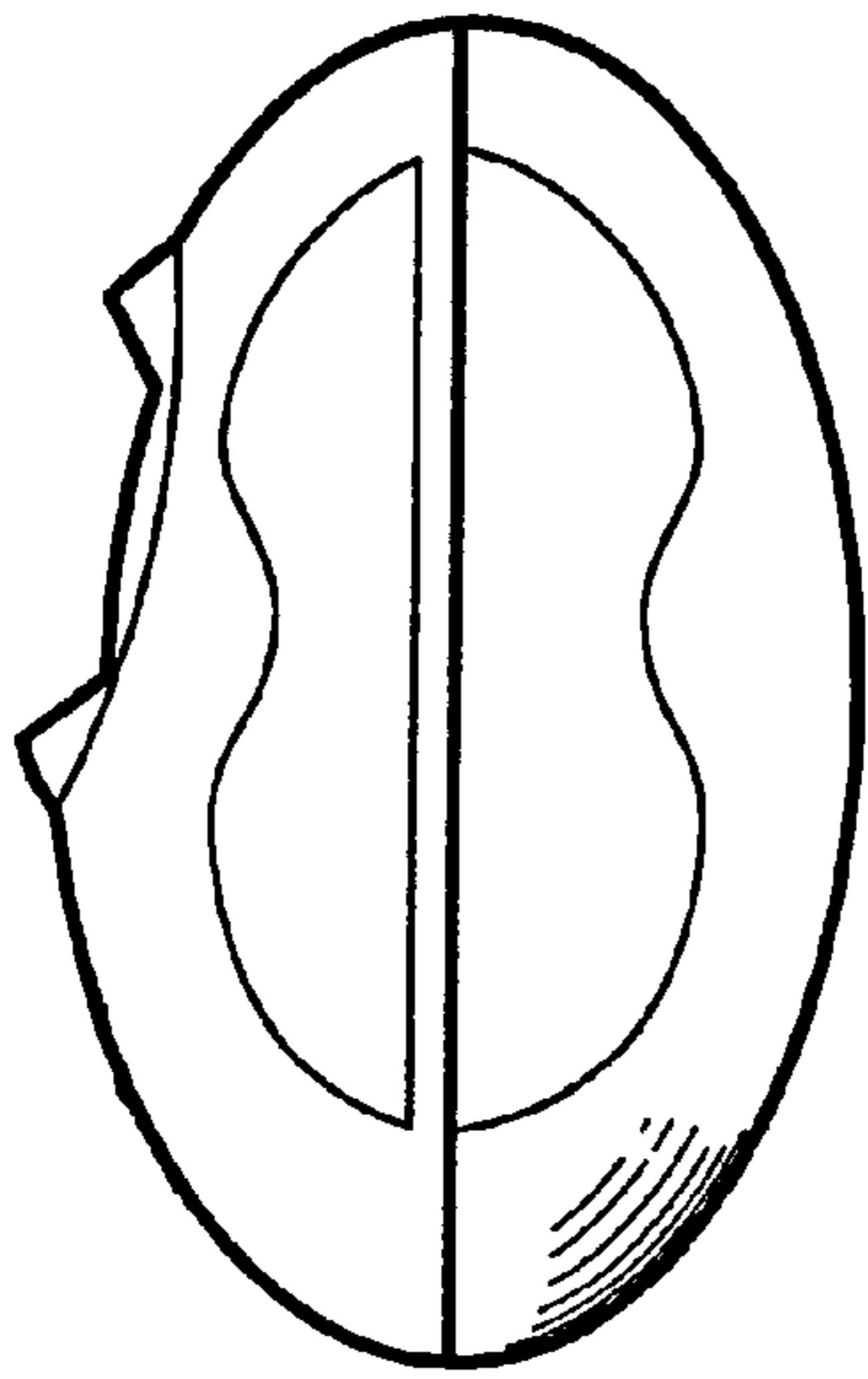

Fig. 15

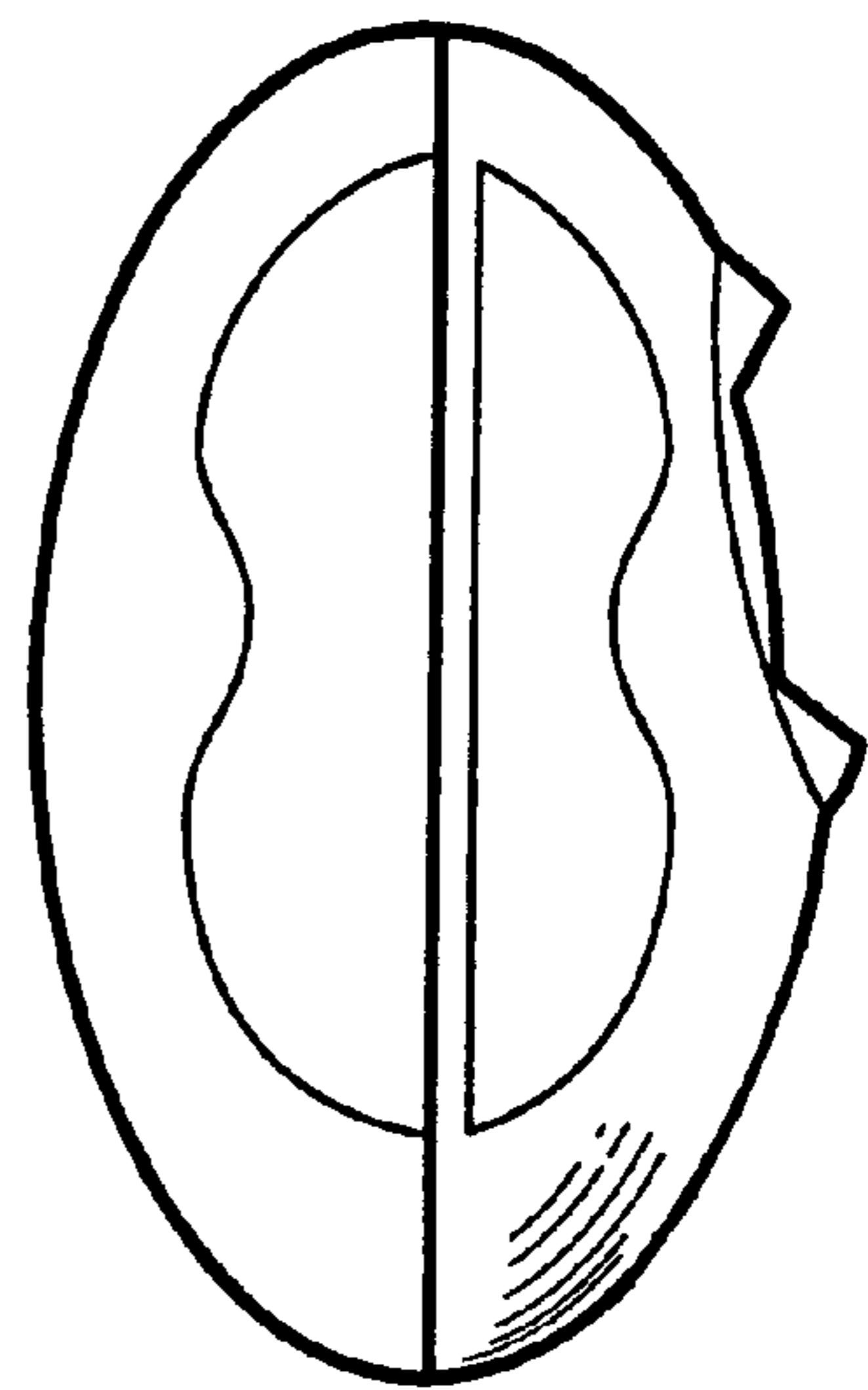

Fig. 16