



US00D428427S

# United States Patent [19] Neef

[11] Patent Number: **Des. 428,427**

[45] Date of Patent: **\*\* Jul. 18, 2000**

[54] **SOLDERING STATION**

[75] Inventor: **Werner Neef**, Stuttgart, Germany

[73] Assignee: **Cooper Tools GmbH**, Besigheim, Germany

[\*\*] Term: **14 Years**

[21] Appl. No.: **29/085,109**

[22] Filed: **Mar. 17, 1998**

[30] **Foreign Application Priority Data**

Sep. 17, 1997 [DE] Germany ..... 97 08 844 U

[51] **LOC (7) Cl.** ..... **15-09**

[52] **U.S. Cl.** ..... **D15/144.2**

[58] **Field of Search** ..... D15/144, 144.2,  
D15/144.1; 219/227, 240, 242; 228/20.5,  
40, 46, 51

[56] **References Cited**

**U.S. PATENT DOCUMENTS**

D. 398,016 9/1998 Neef ..... D15/144.2  
5,048,742 9/1991 Fortune ..... 228/20

**OTHER PUBLICATIONS**

“Professional Beauty Skin”, *The Beauty Care Supply Guide* 1996, 1996.

*Primary Examiner*—Antoine Duval Davis  
*Attorney, Agent, or Firm*—Coats & Bennett, PLLC

[57] **CLAIM**

The ornamental design for a soldering station, as shown and described.

**DESCRIPTION**

FIG. 1 is a perspective view of a soldering station showing a first embodiment of my new design;

FIG. 2 is a front elevation view thereof;  
FIG. 3 is a rear elevation view thereof;  
FIG. 4 is a bottom plan view thereof;  
FIG. 5 is a side elevation view thereof;  
FIG. 6 is a side elevation view thereof, opposite that shown in FIG. 5;  
FIG. 7 is a perspective view of a soldering station showing a second embodiment of my new design;  
FIG. 8 is a front elevation view thereof;  
FIG. 9 is a rear elevation view thereof;  
FIG. 10 is a bottom plan view thereof;  
FIG. 11 is a side elevation view thereof;  
FIG. 12 is a side elevation view thereof, opposite that shown in FIG. 11;  
FIG. 13 is a top view thereof;  
FIG. 14 is a perspective view of a soldering station showing a third embodiment of my new design;  
FIG. 15 is a front elevation view thereof;  
FIG. 16 is a rear elevation view thereof;  
FIG. 17 is a bottom plan view thereof;  
FIG. 18 is a side elevation view thereof;  
FIG. 19 is a side elevation view thereof, opposite that shown in FIG. 18;  
FIG. 20 is a perspective view of a soldering station showing a fourth embodiment of my new design;  
FIG. 21 is a front elevation view thereof;  
FIG. 22 is a rear elevation view thereof;  
FIG. 23 is a bottom plan view thereof;  
FIG. 24 is a side elevation view thereof;  
FIG. 25 is a side elevation view thereof, opposite that shown in FIG. 24; and,  
FIG. 26 is a top view thereof.

**1 Claim, 26 Drawing Sheets**

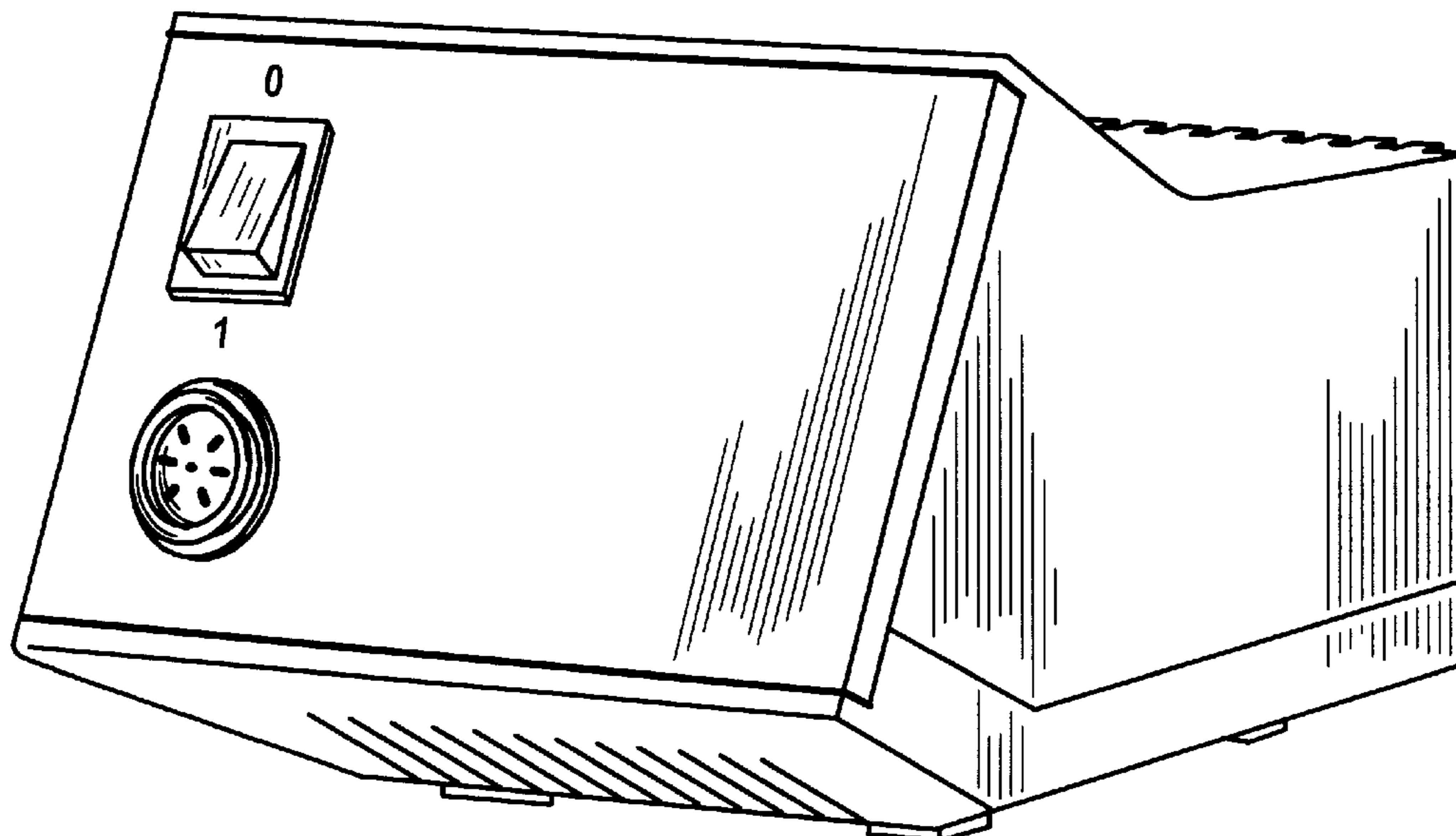

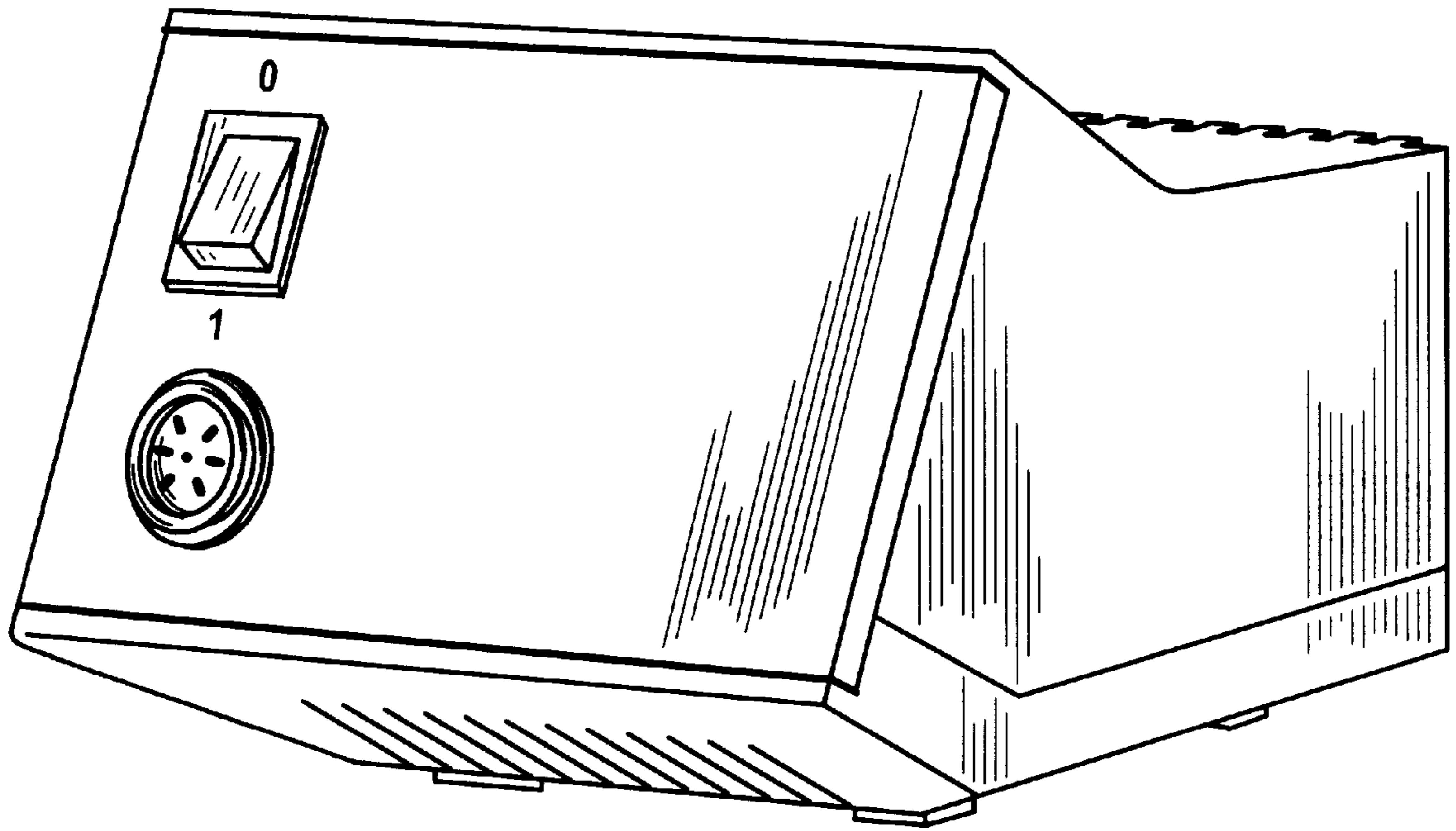

FIG. 1

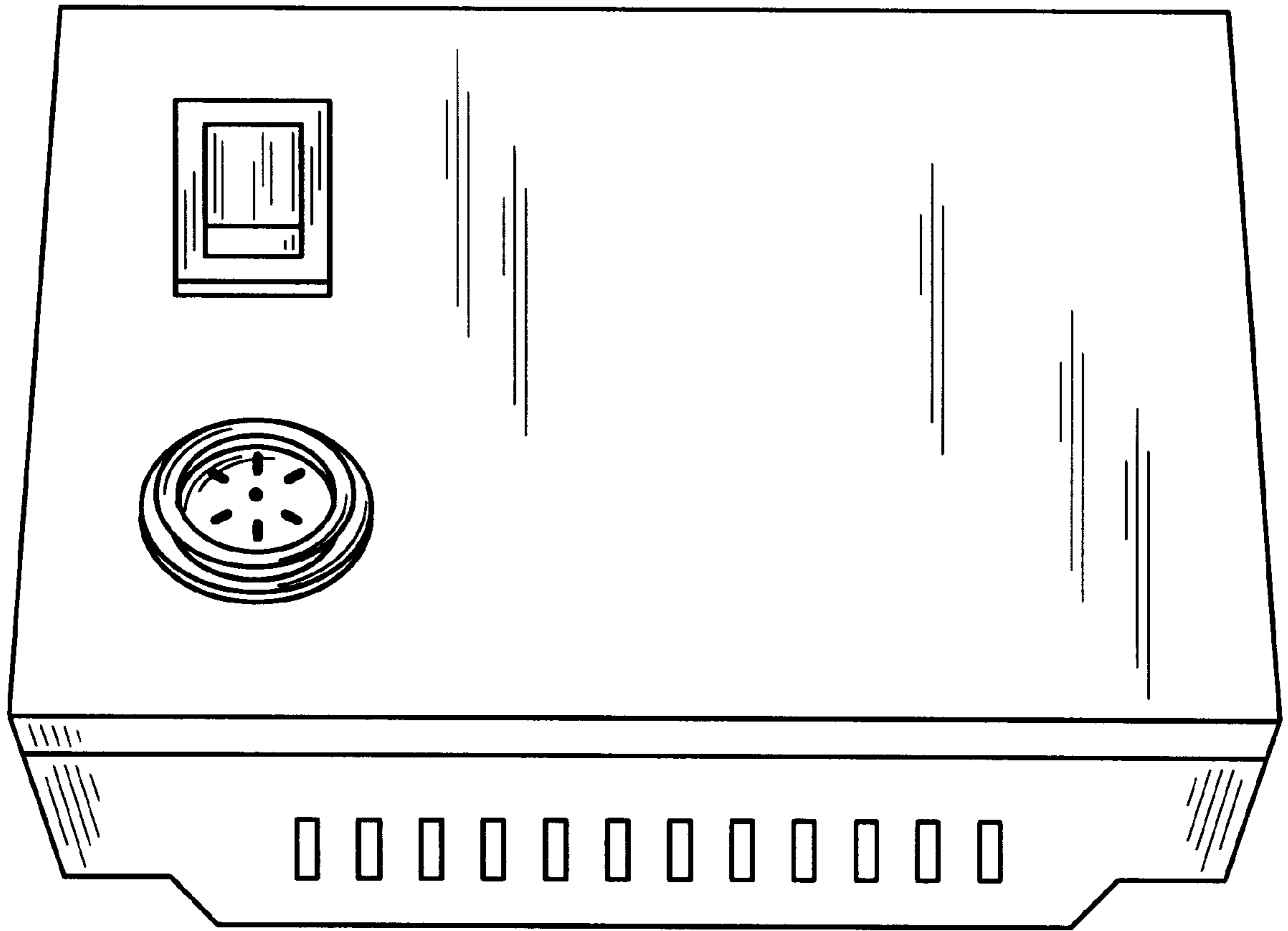

FIG. 2

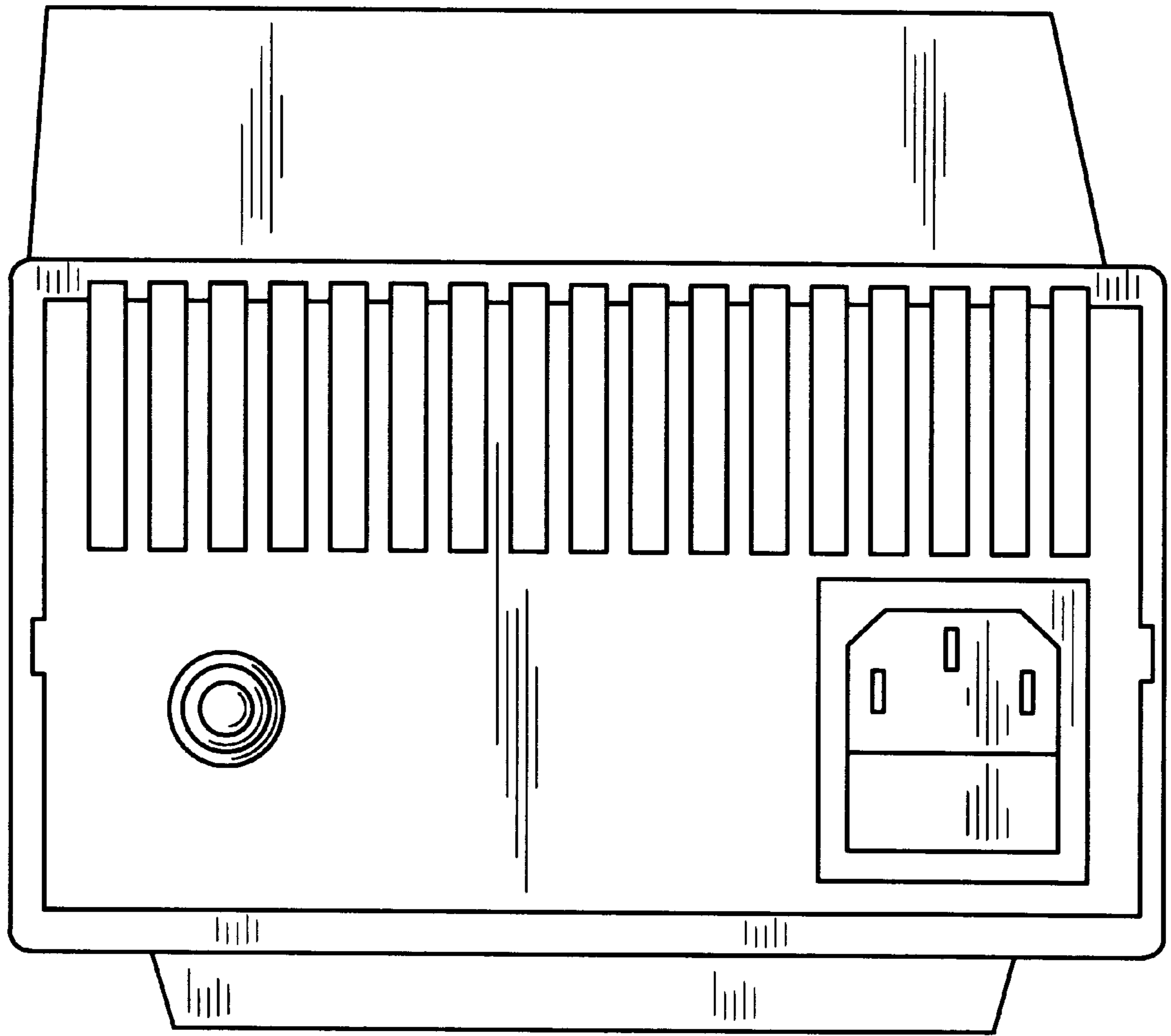

FIG. 3

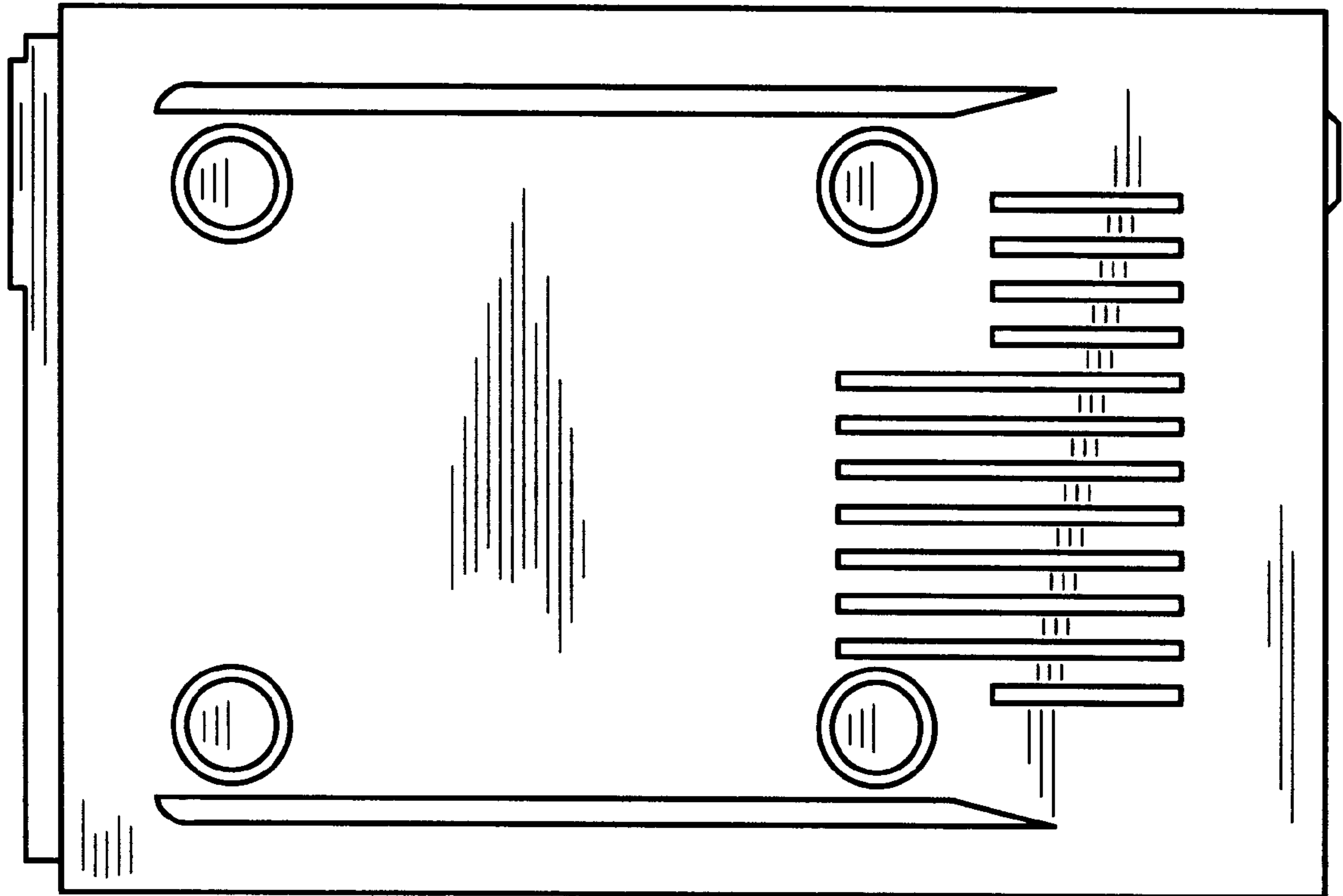

FIG. 4

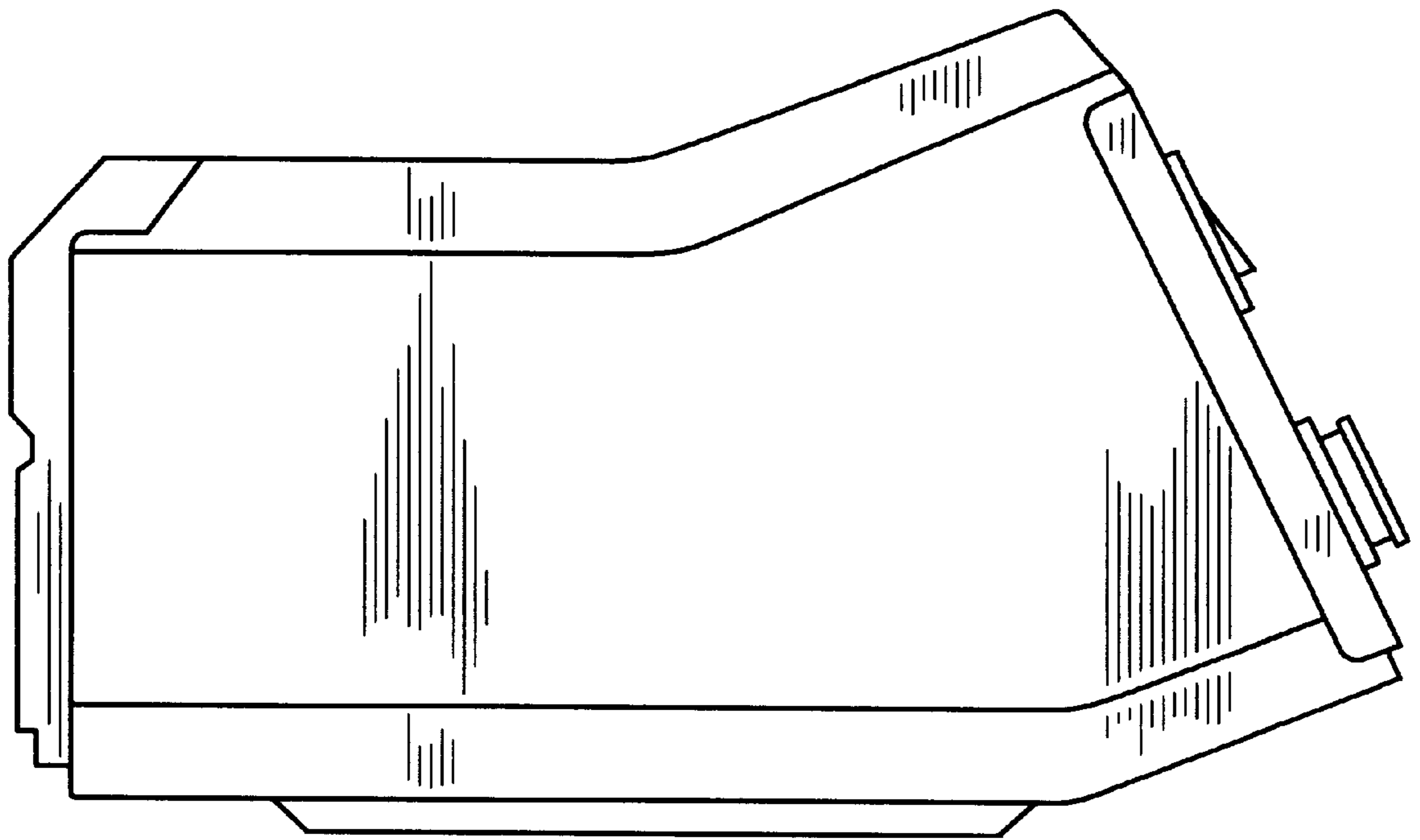

FIG. 5

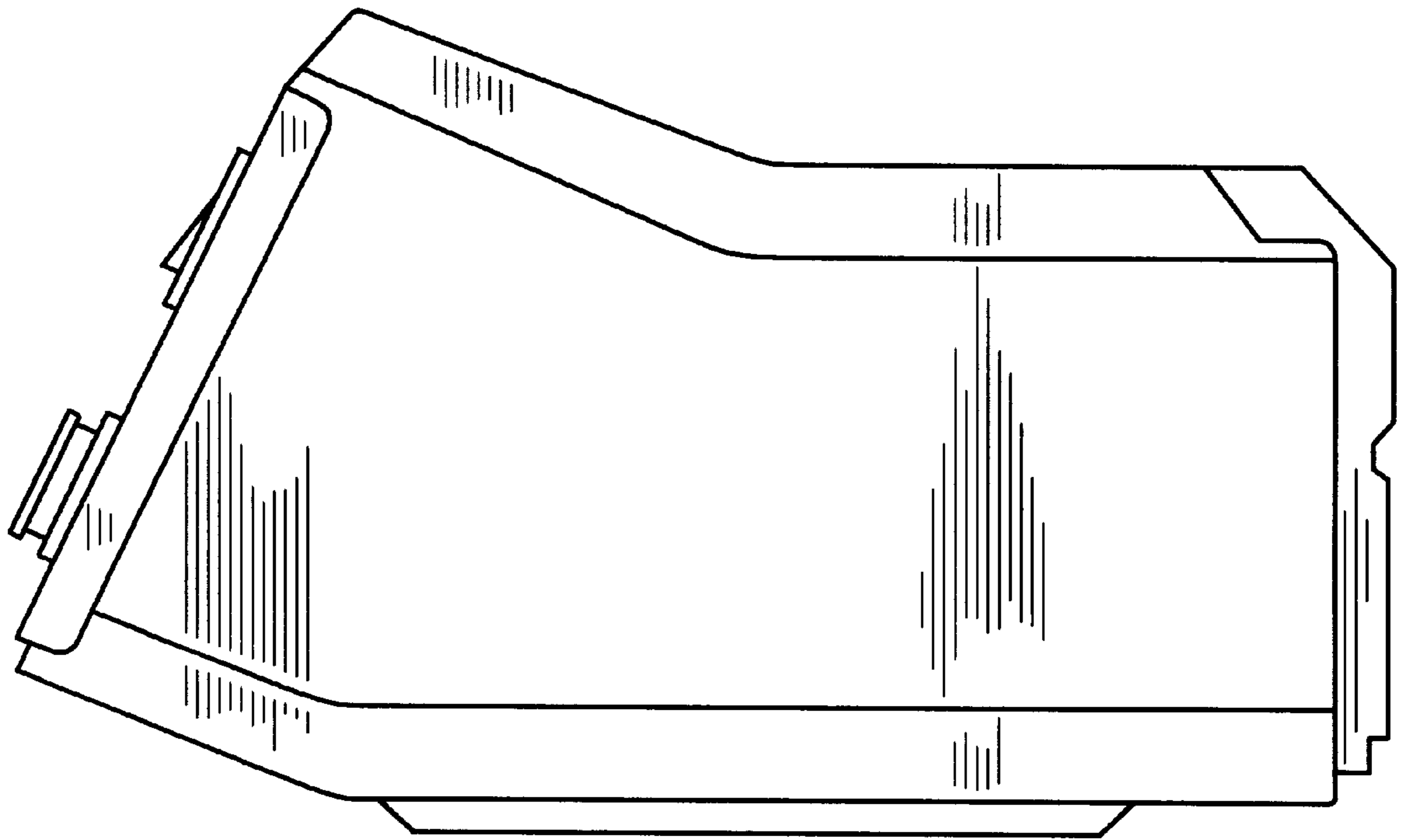

FIG. 6

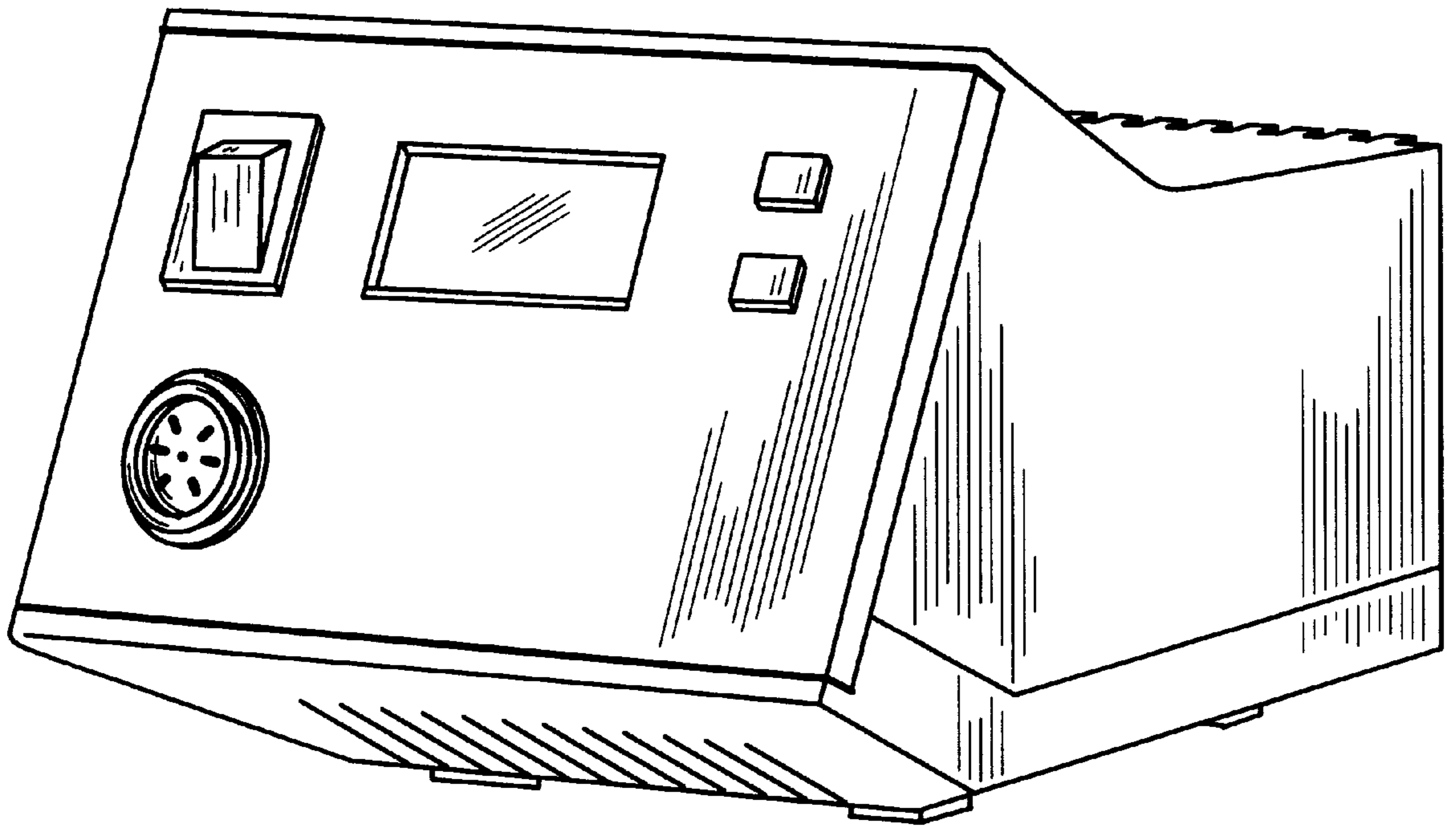

FIG. 7



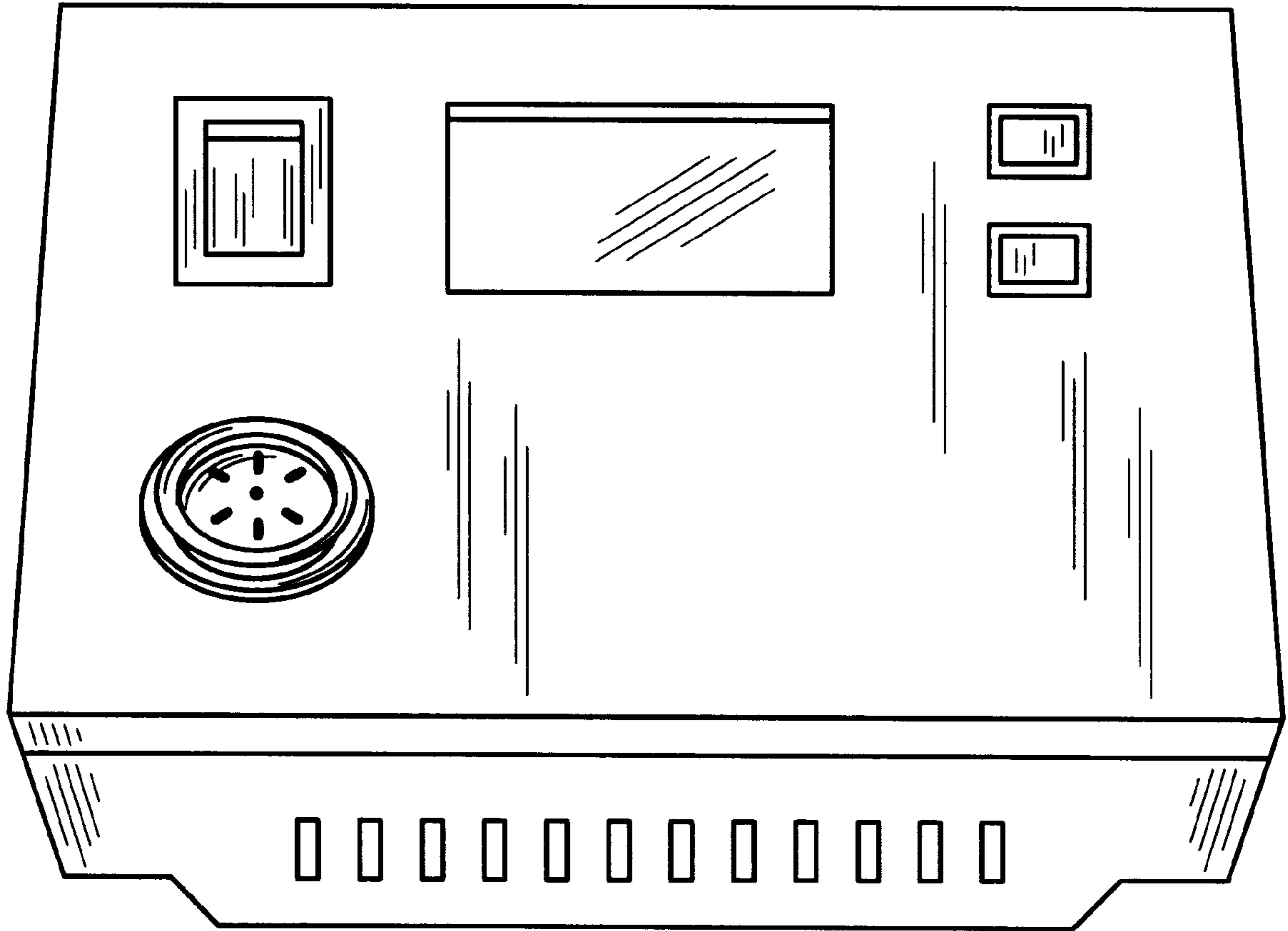

FIG. 8

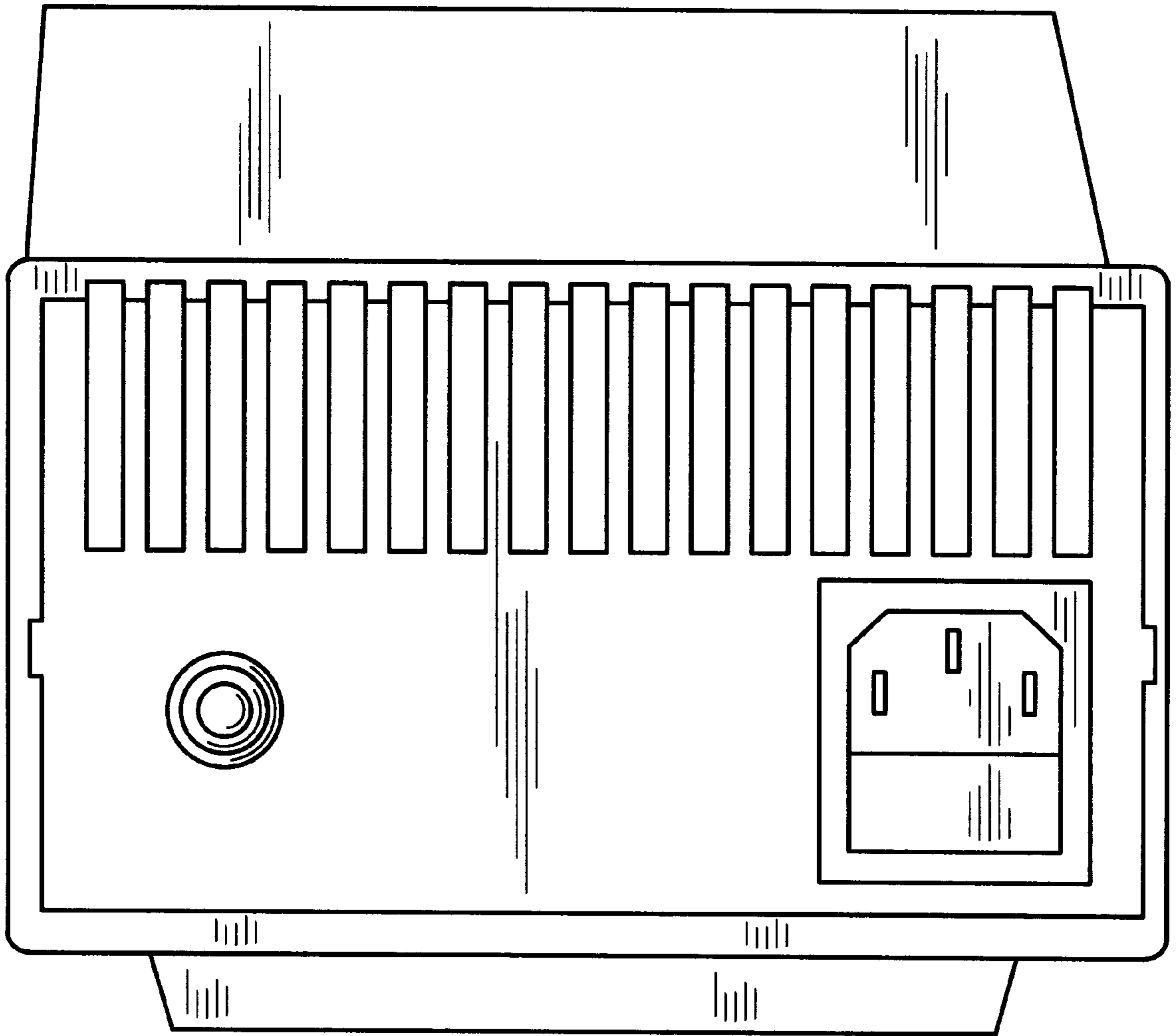

FIG. 9

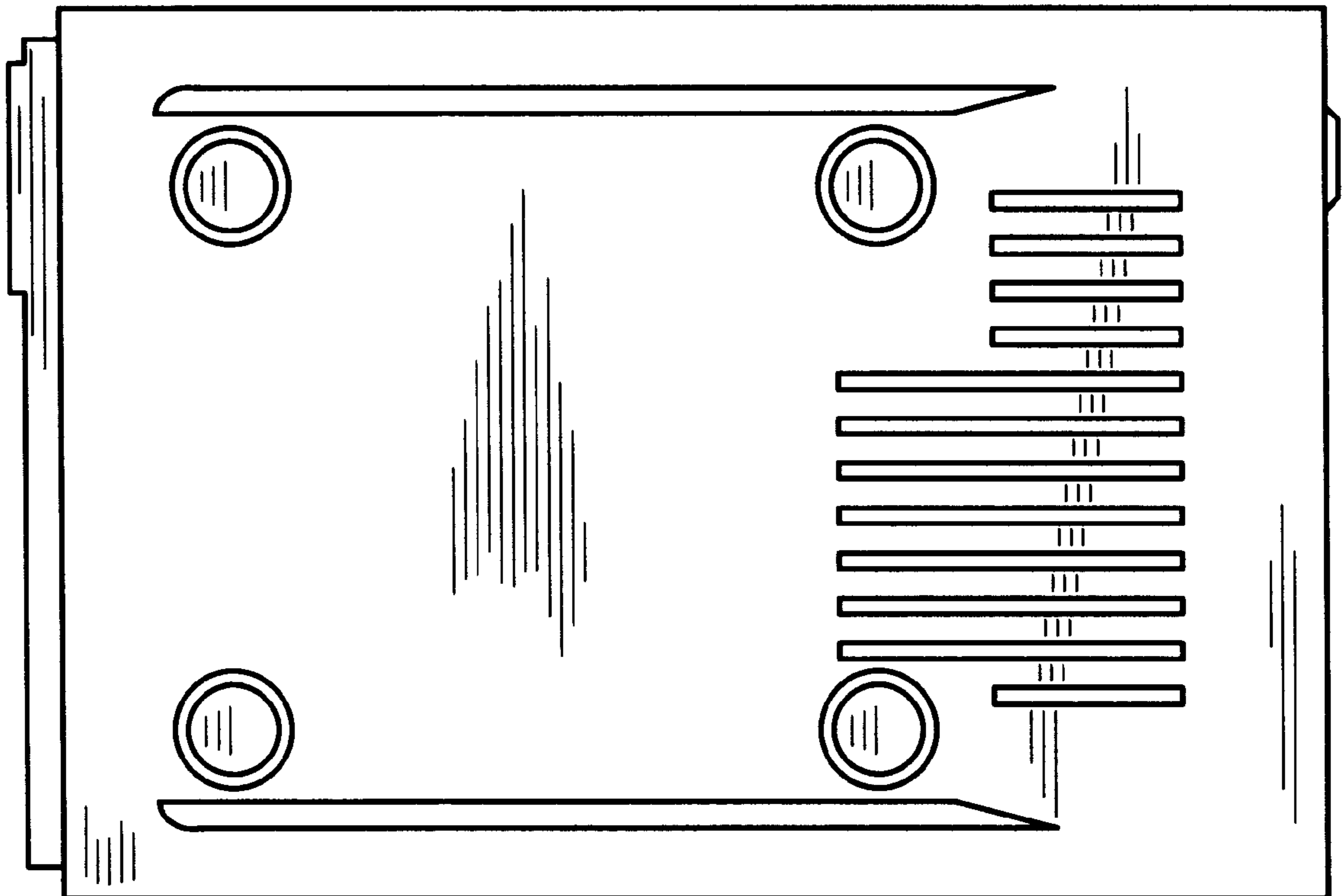

FIG. 10

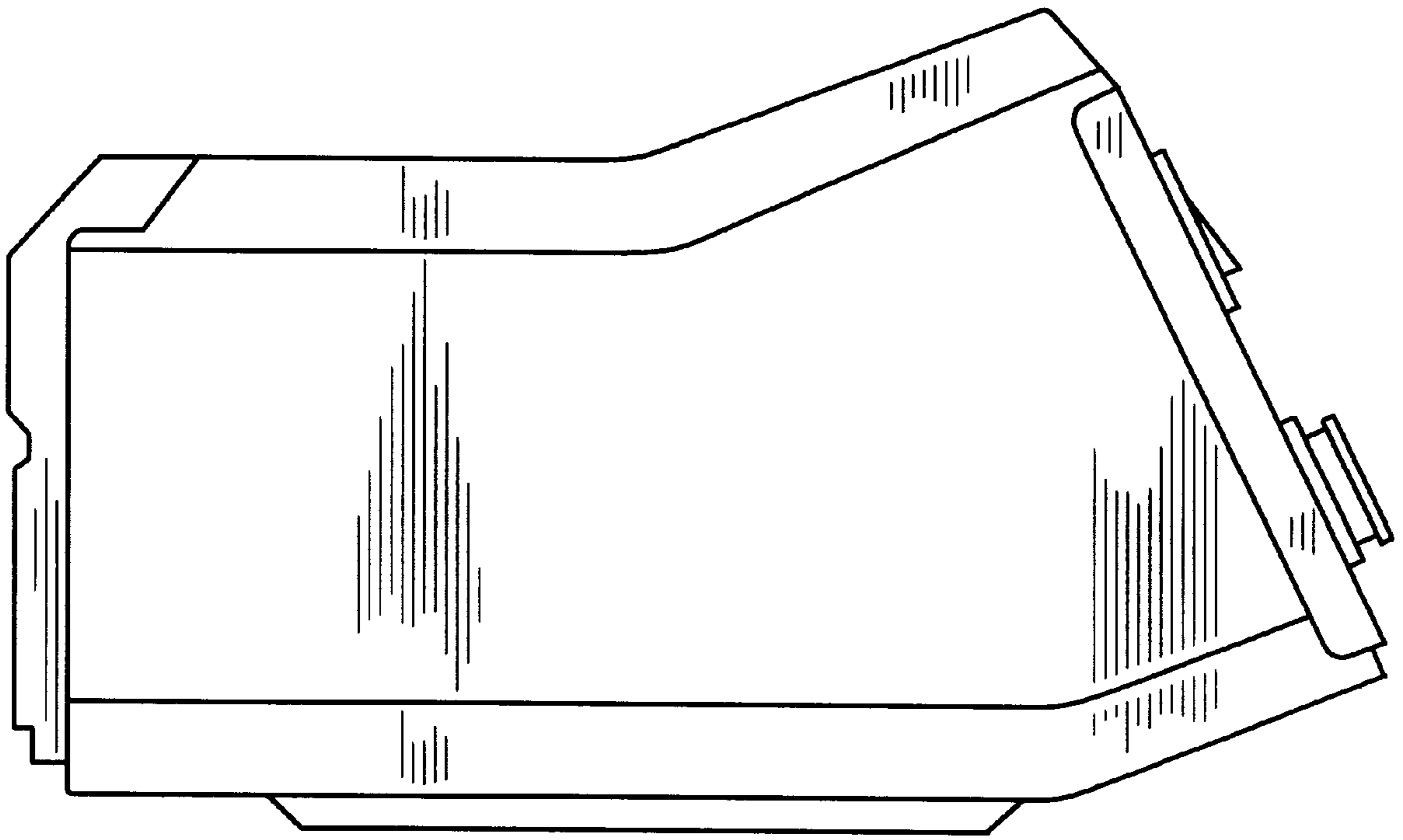

FIG. 11

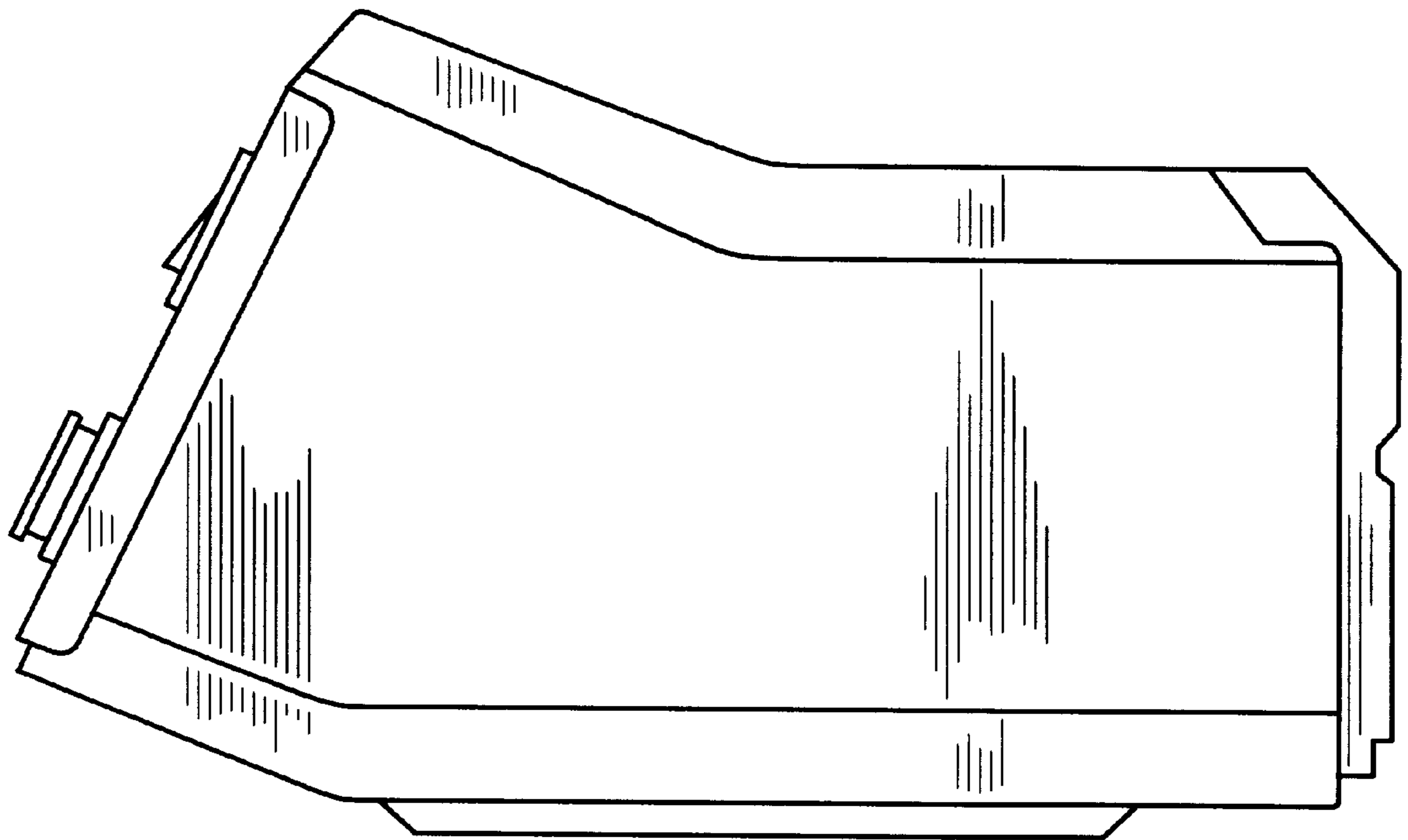

FIG. 12

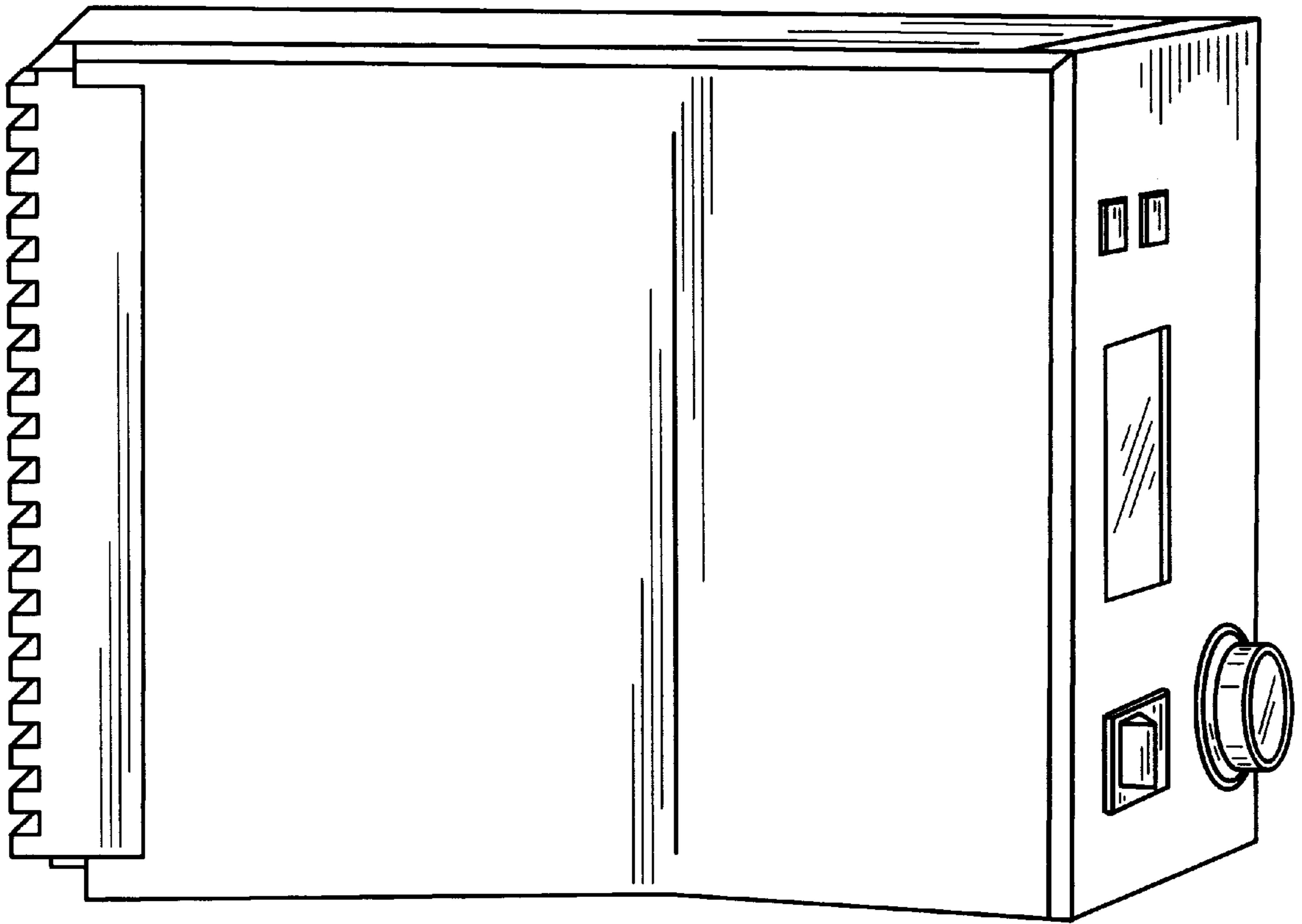

FIG. 13

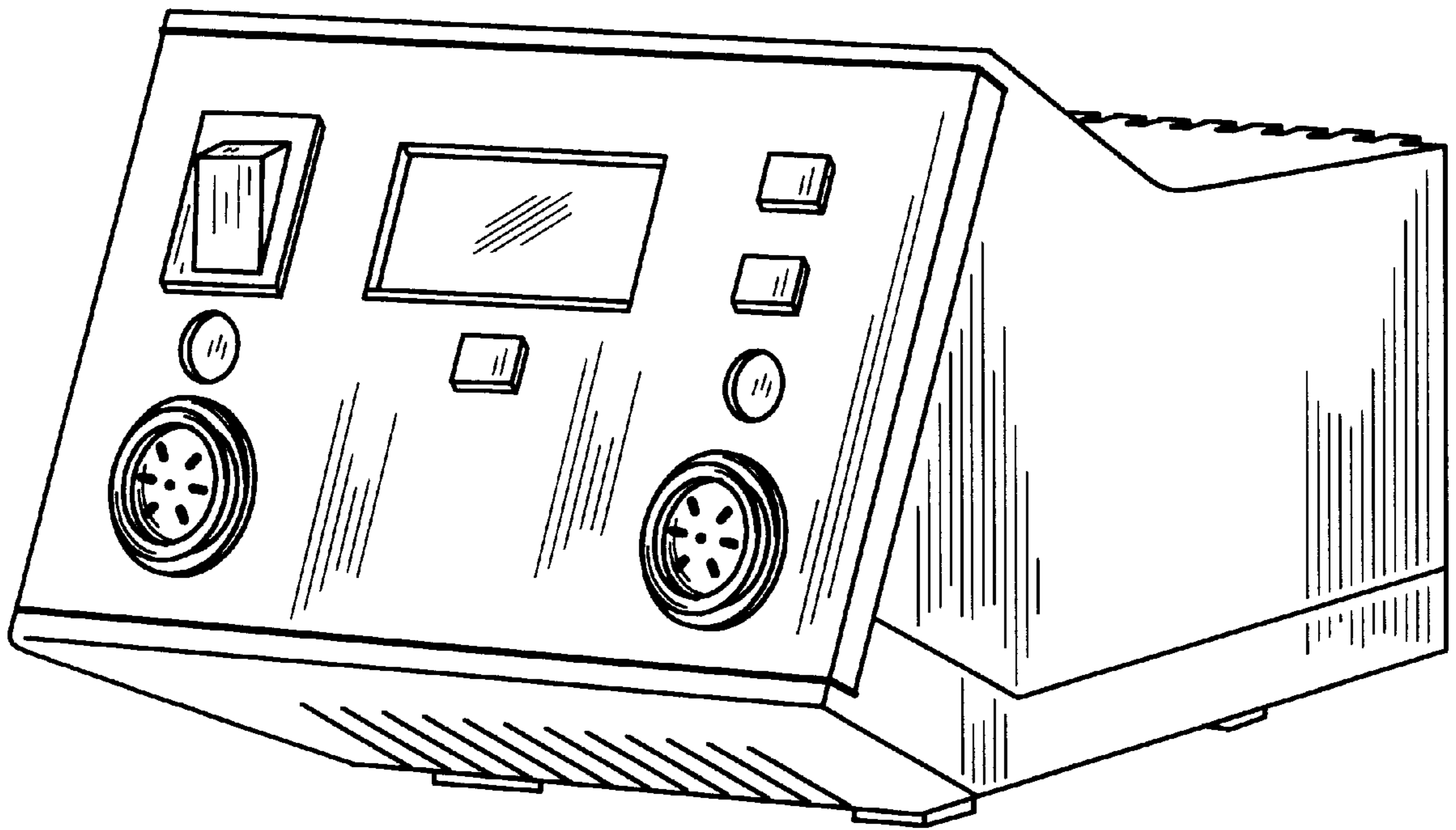

FIG. 14

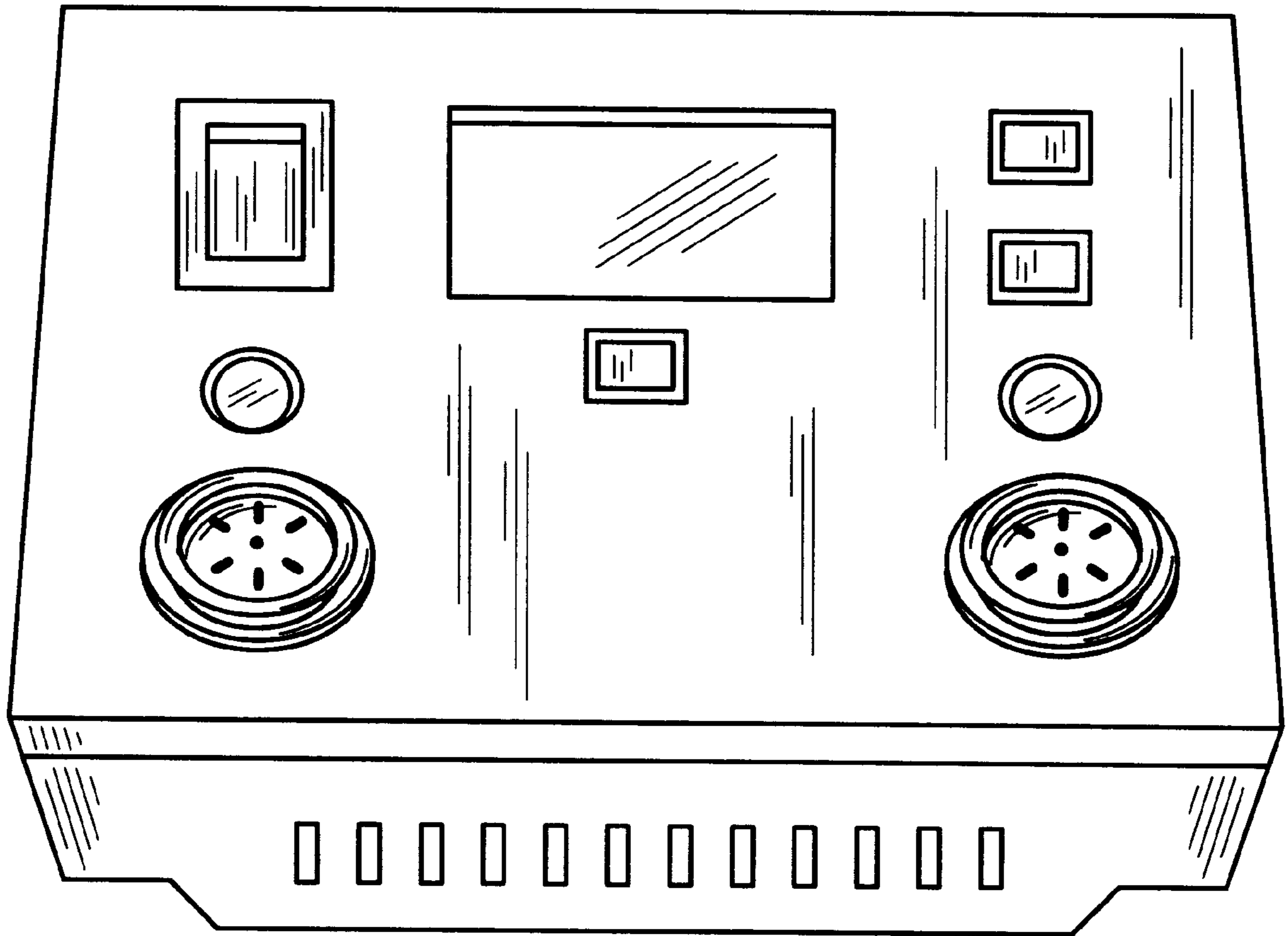

FIG. 15



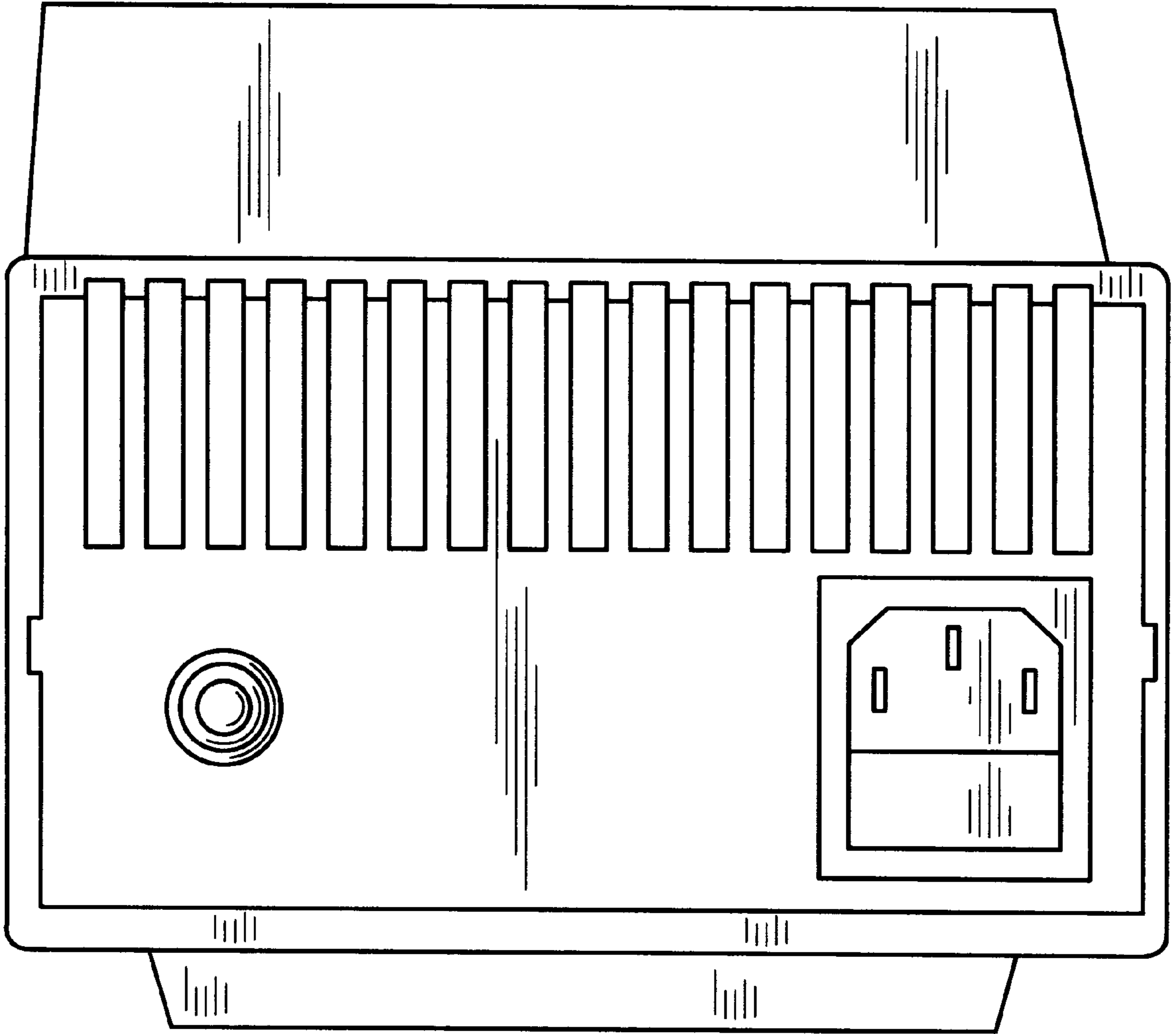

FIG. 16

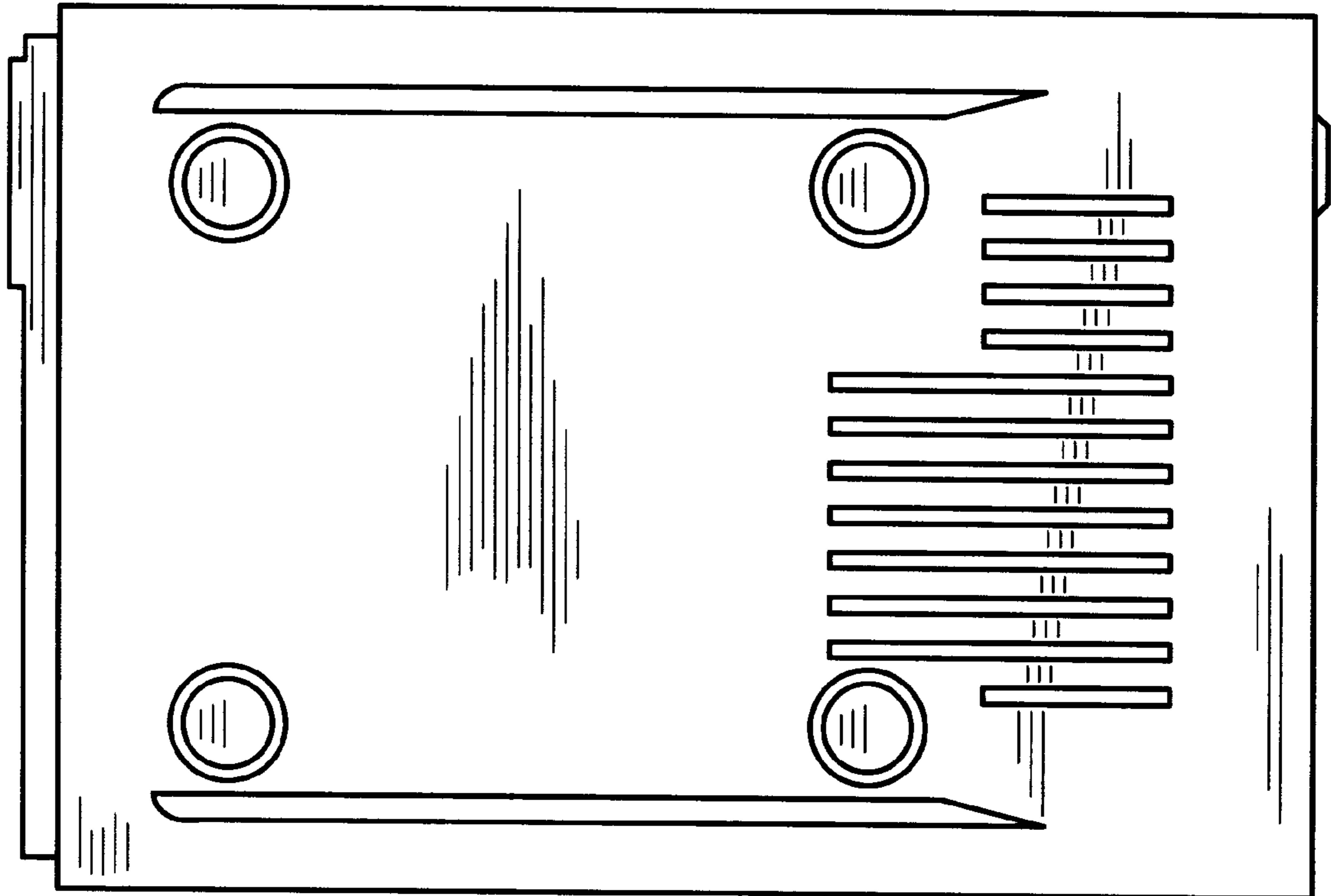

FIG. 17

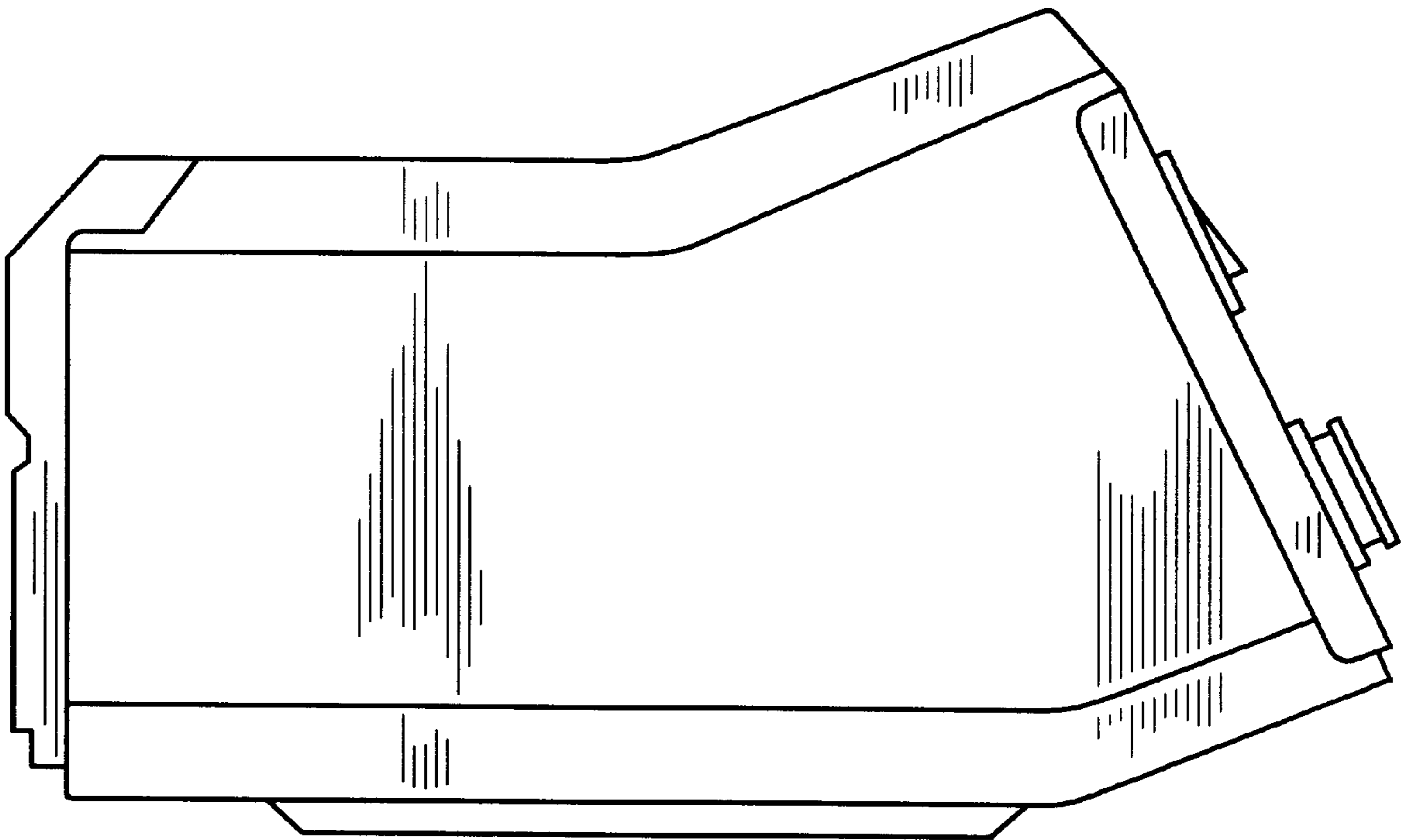

FIG. 18

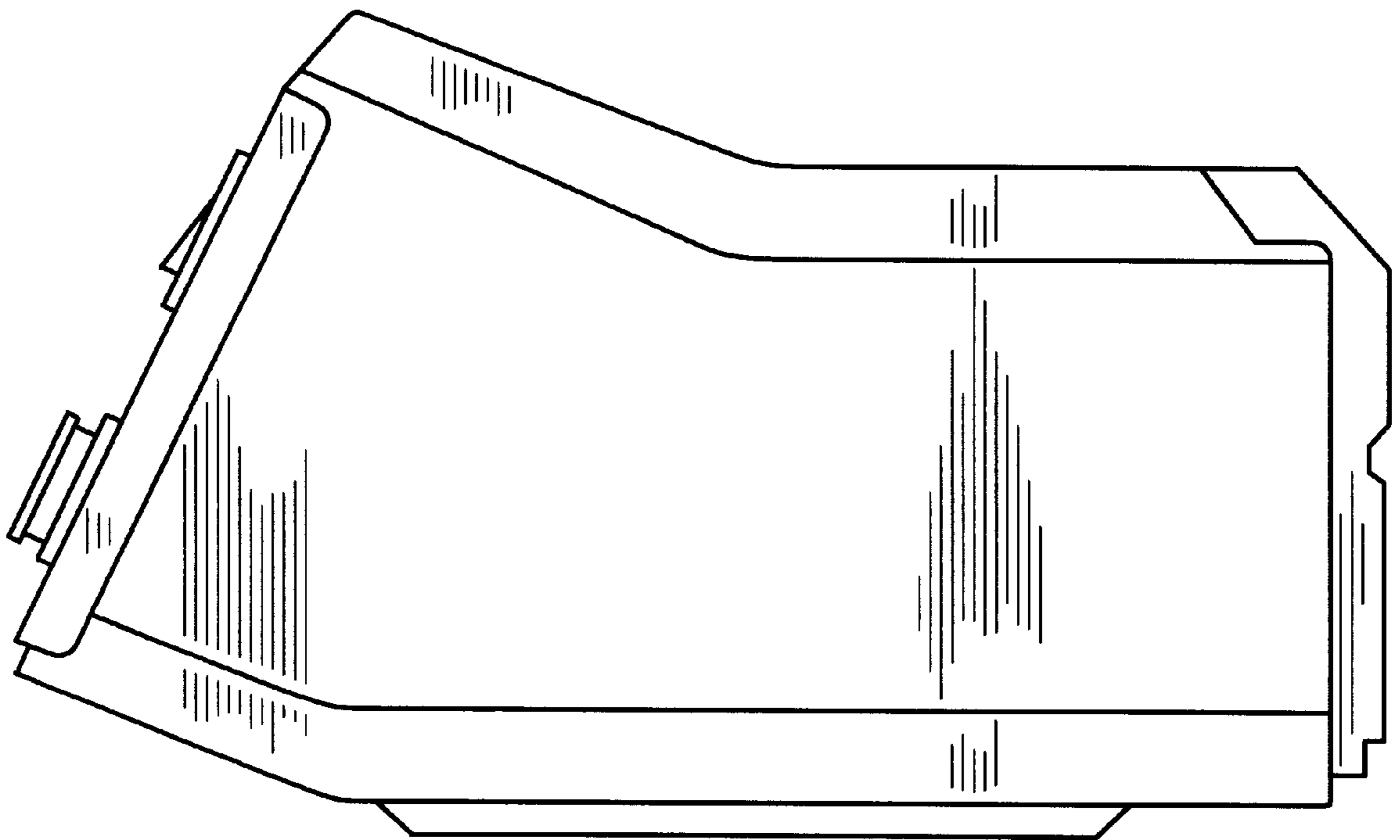

FIG. 19

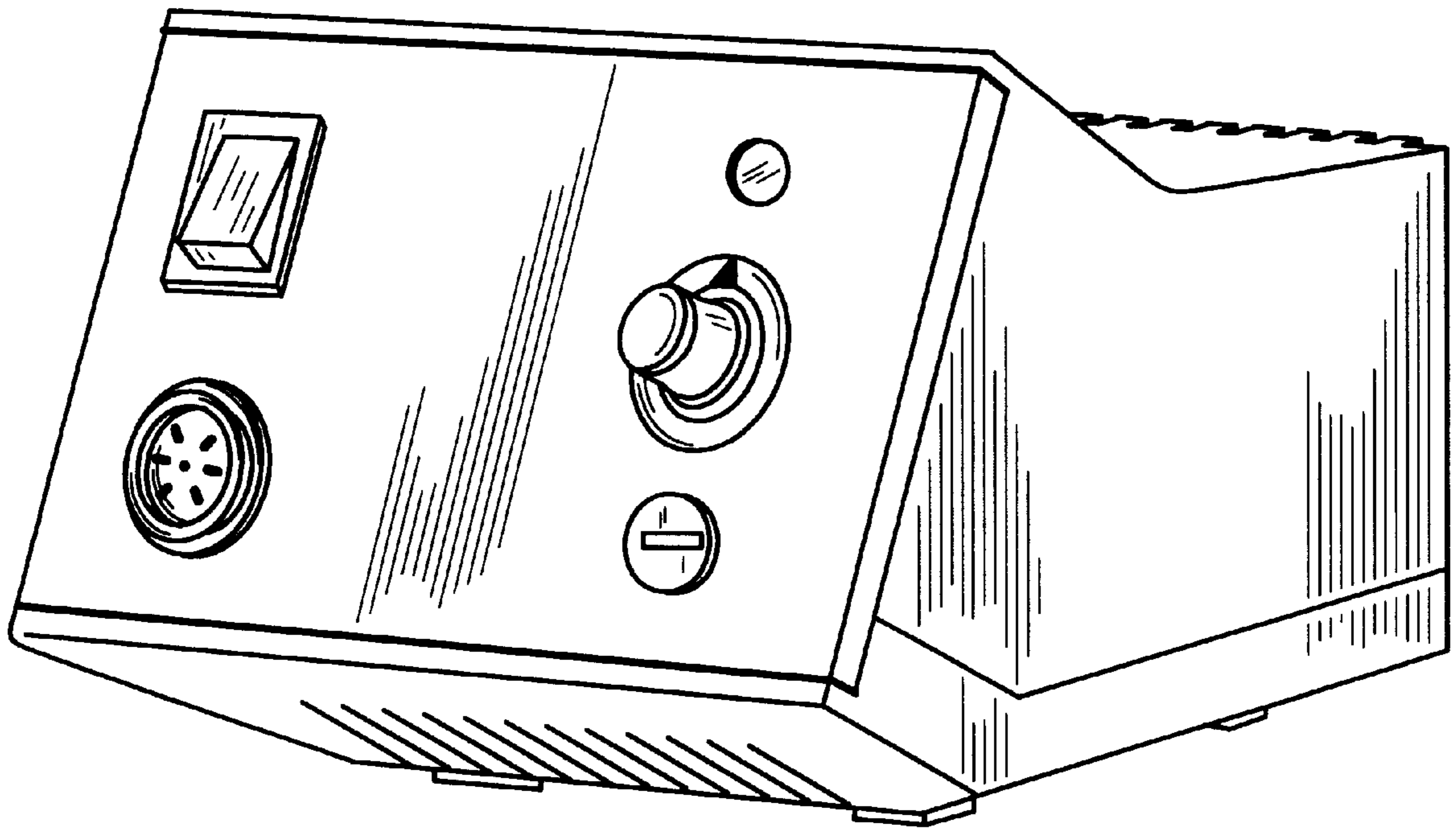

FIG. 20

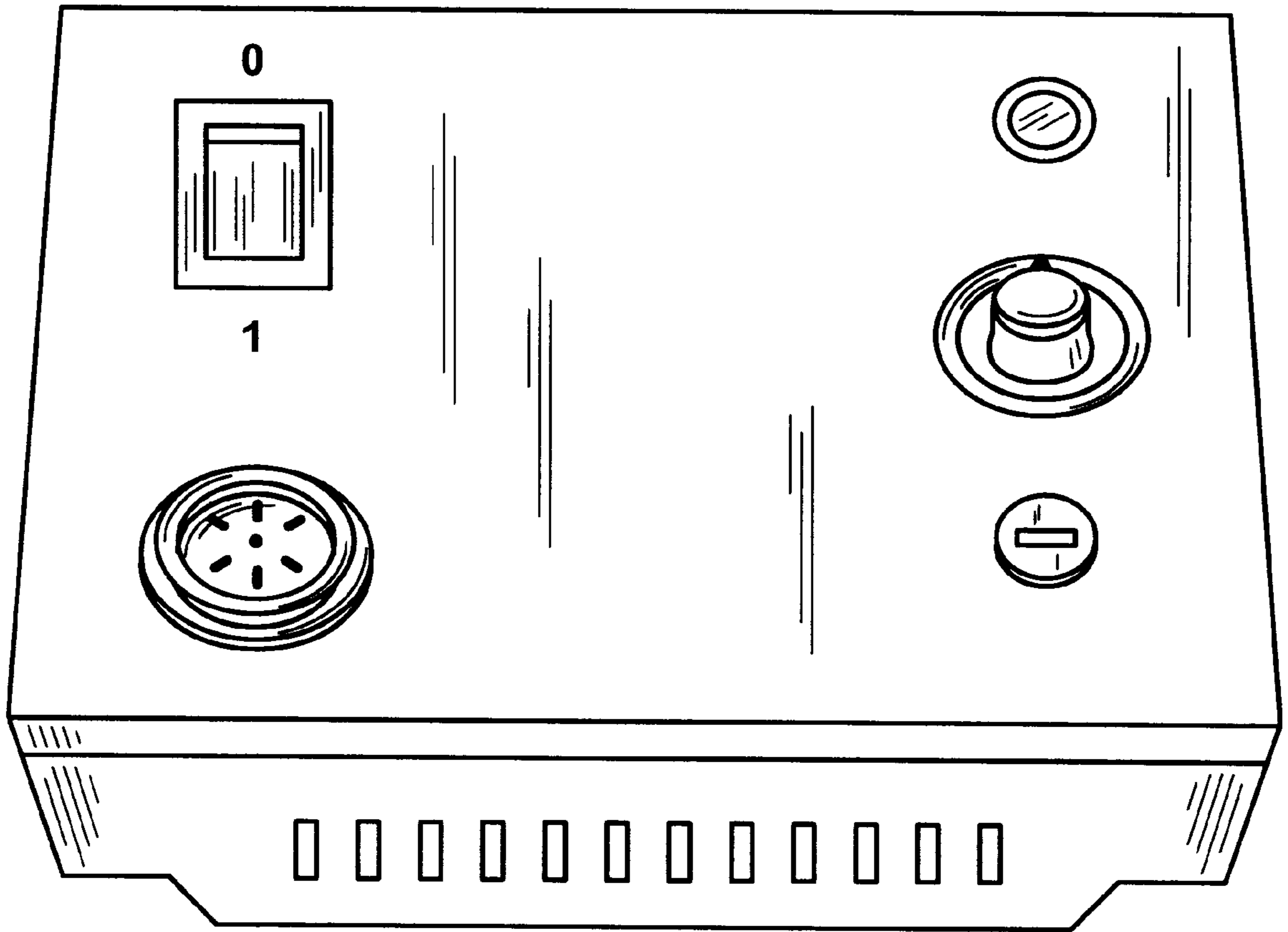

FIG. 21

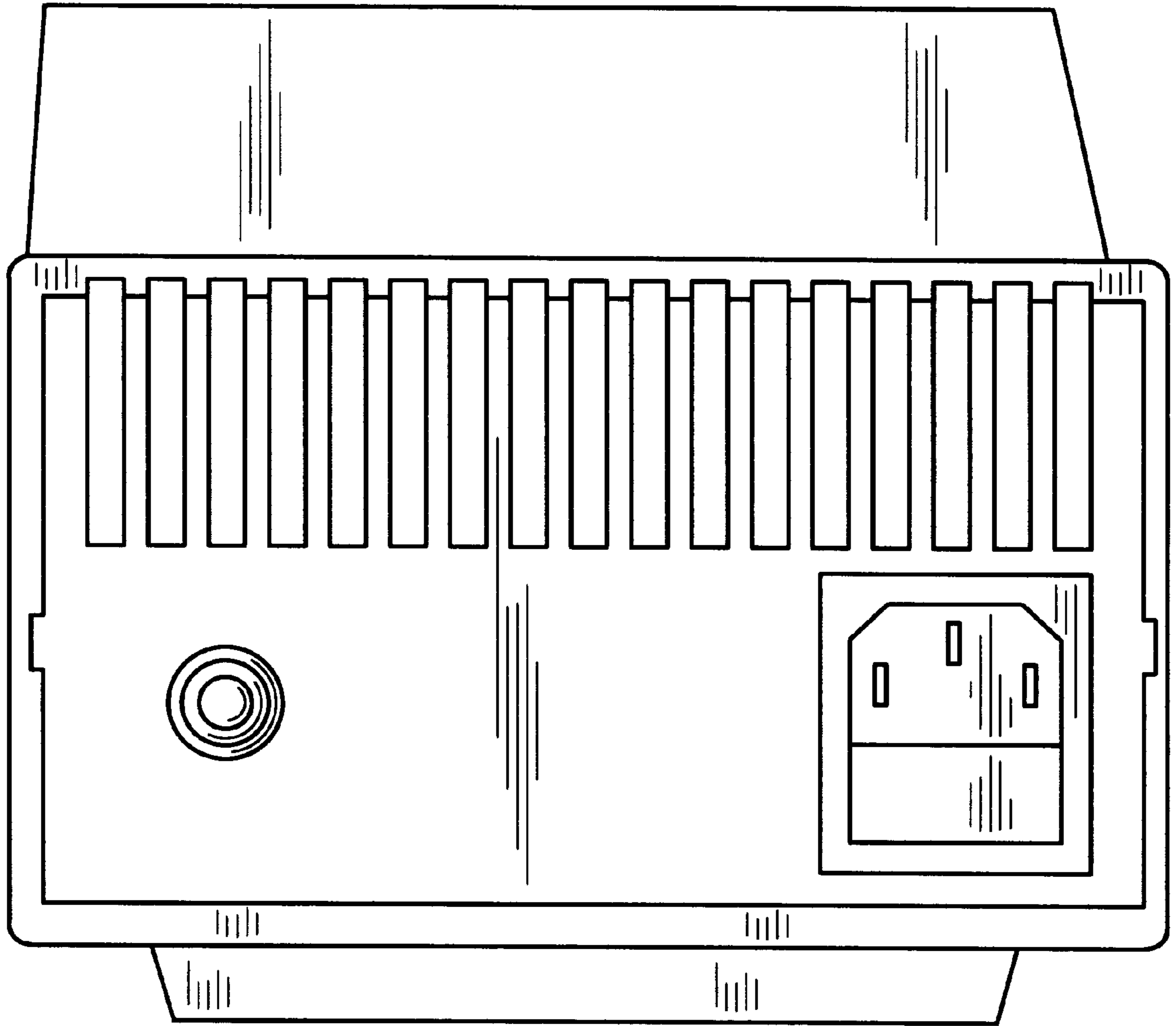

FIG. 22

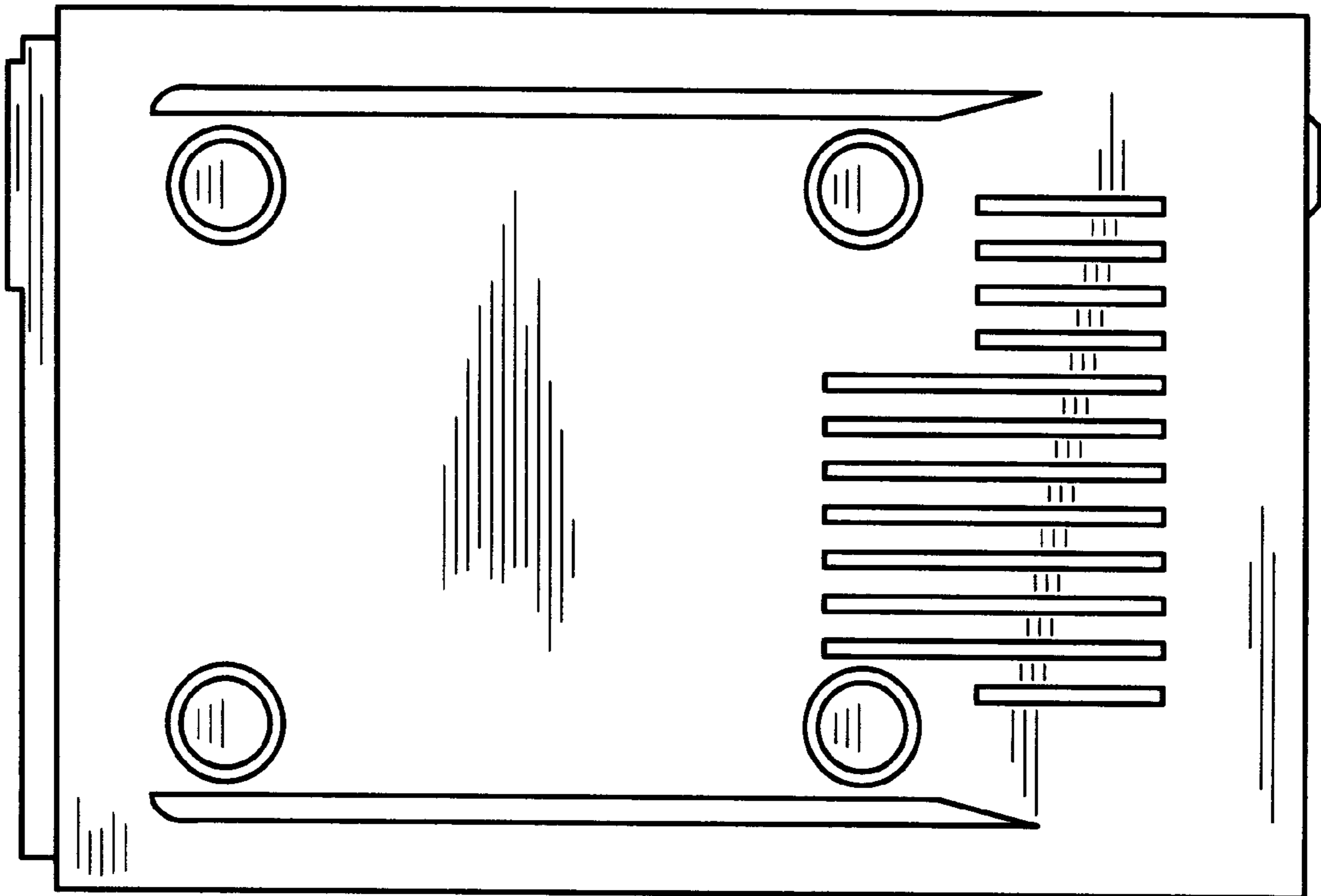

FIG. 23



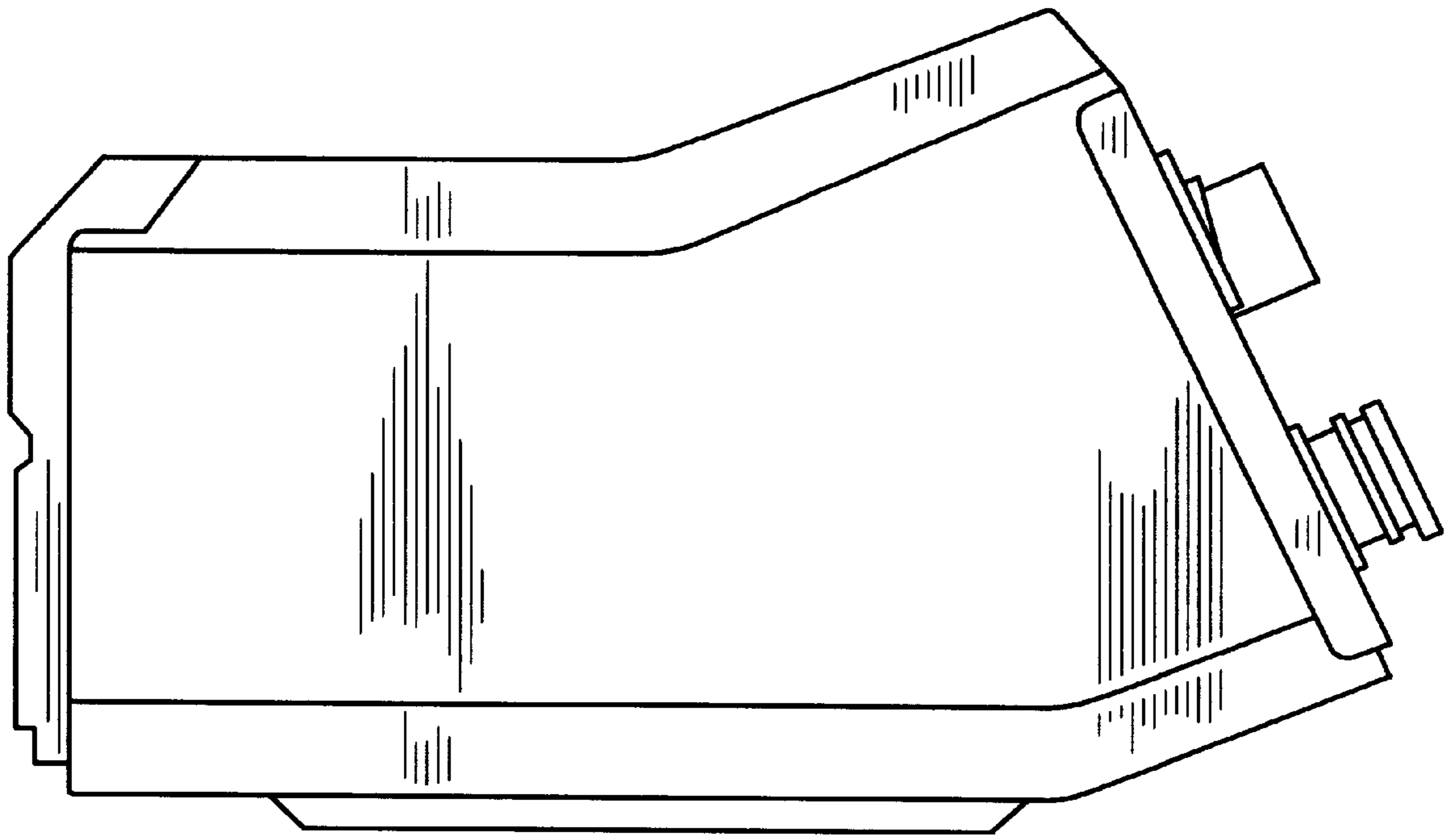

FIG. 24

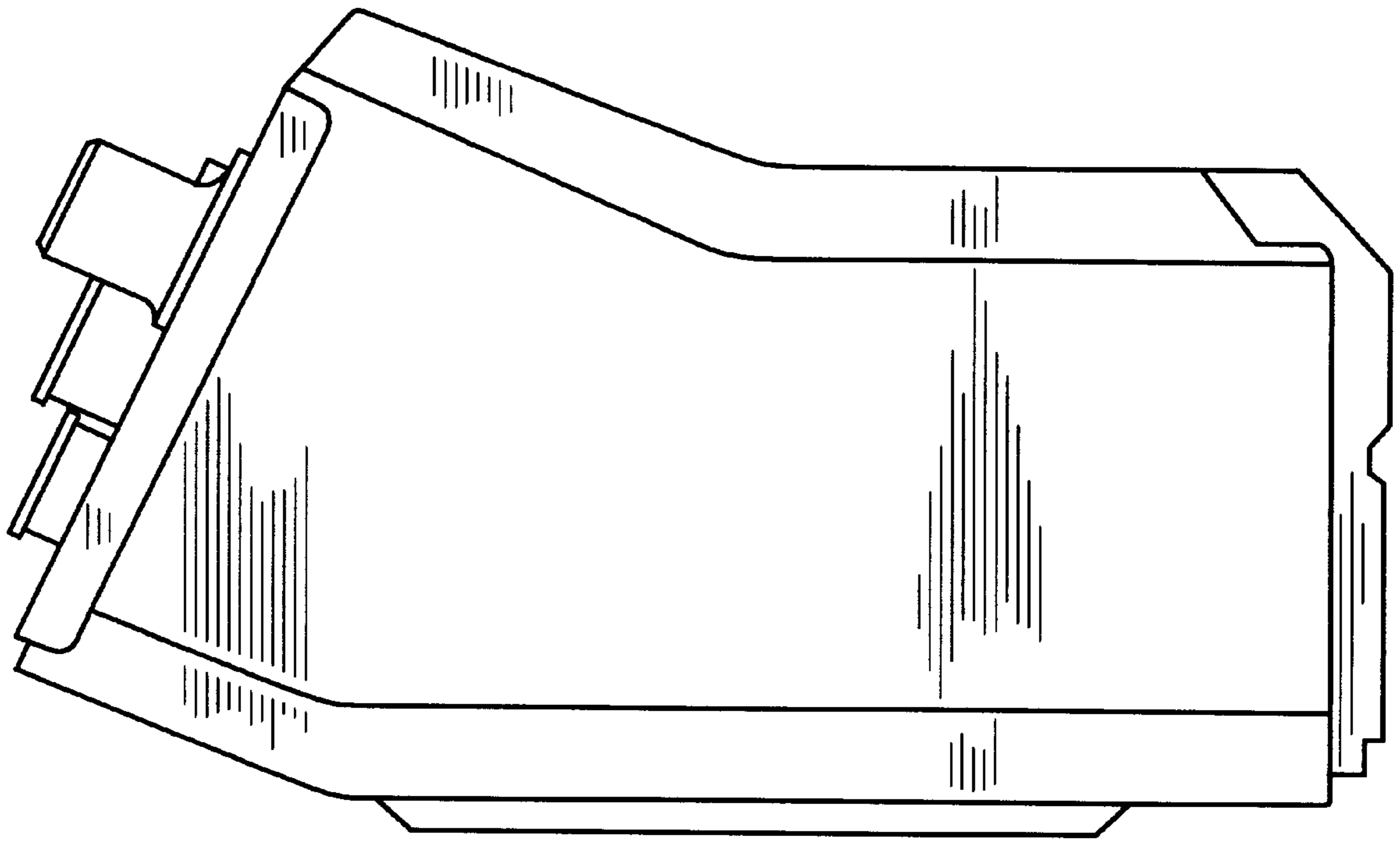

FIG. 25

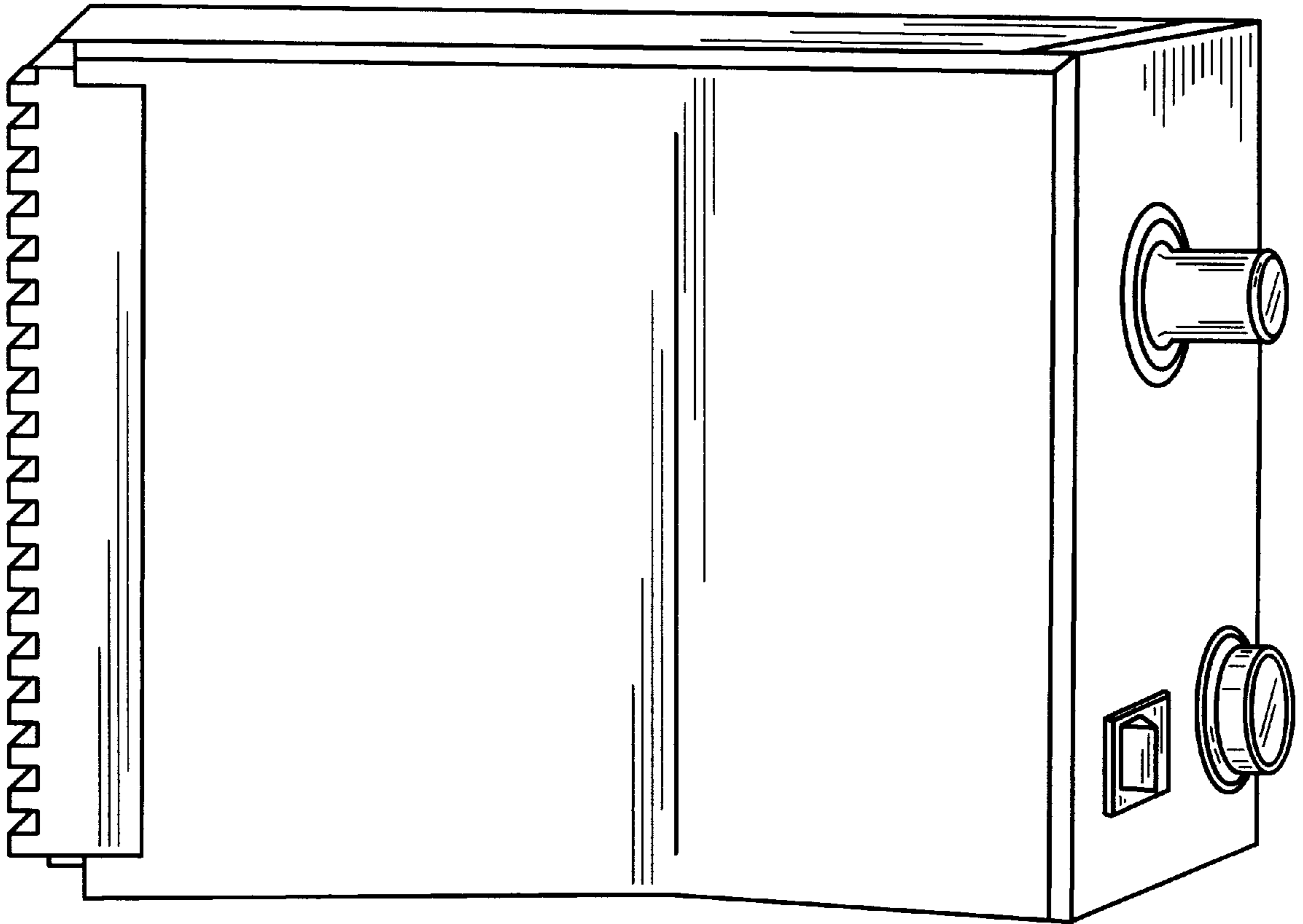

FIG. 26