



US00D428388S

United States Patent [19]

Nagahara et al.

[11] Patent Number: **Des. 428,388**

[45] Date of Patent: **** Jul. 18, 2000**

[54] **POWER SUPPLY APPARATUS**

[75] Inventors: **Kuniaki Nagahara; Toshio Watanabe; Masaharu Maesaka**, all of Toyama, Japan

[73] Assignee: **Cosel Co., Ltd.**, Toyama, Japan

[**] Term: **14 Years**

[21] Appl. No.: **29/105,335**

[22] Filed: **May 21, 1999**

[30] **Foreign Application Priority Data**

Jan. 11, 1999 [JP] Japan 11-454

[51] **LOC (7) Cl.** **13-02**

[52] **U.S. Cl.** **D13/110**

[58] **Field of Search** D13/110; 307/150; 361/836

[56] **References Cited**

U.S. PATENT DOCUMENTS

D. 260,875	9/1981	Tully, Jr.	D13/110
4,039,900	8/1977	Roback et al.	361/709
4,471,898	9/1984	Parker	228/20.5
4,853,828	8/1989	Penn	361/717
5,016,139	5/1991	Stopa et al.	361/720

5,297,025	3/1994	Shoquist et al.	361/704
5,550,853	8/1996	Ostler	372/34
5,640,061	6/1997	Bornhorst et al.	307/150
5,680,294	10/1997	Stora et al.	361/695

OTHER PUBLICATIONS

Power-One power supplies at p. 186 in Arrow Electronics 1988 catalog.

Primary Examiner—Joel Sincavage
Attorney, Agent, or Firm—Wenderoth, Lind & Ponack, L.L.P.

[57] **CLAIM**

The ornamental design for a power supply apparatus, as shown and described.

DESCRIPTION

FIG. 1 is a top view of a power supply apparatus in accordance with the present design;
FIG. 2 is a front view thereof;
FIG. 3 is a bottom view thereof;
FIG. 4 is a rear view thereof;
FIG. 5 is a left side view thereof;
FIG. 6 is a right side view thereof; and,
FIG. 7 is a perspective view thereof.

1 Claim, 3 Drawing Sheets

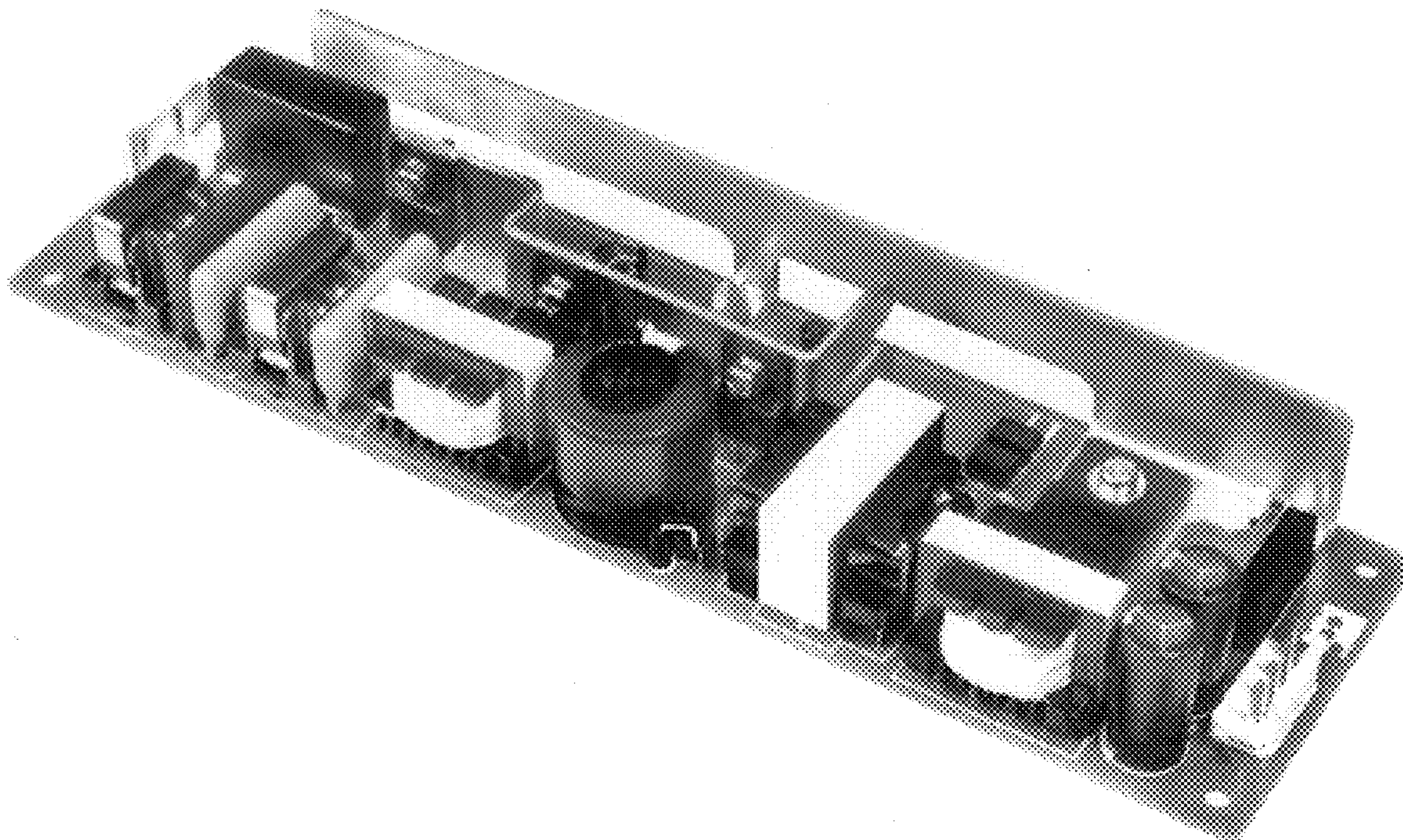

FIG. 1

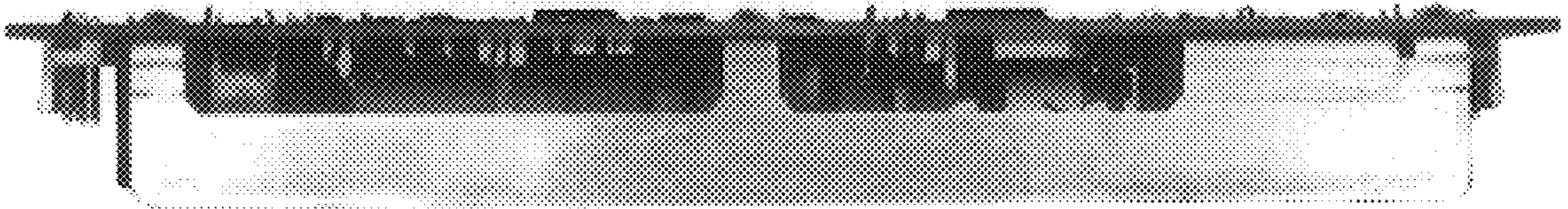

FIG. 2

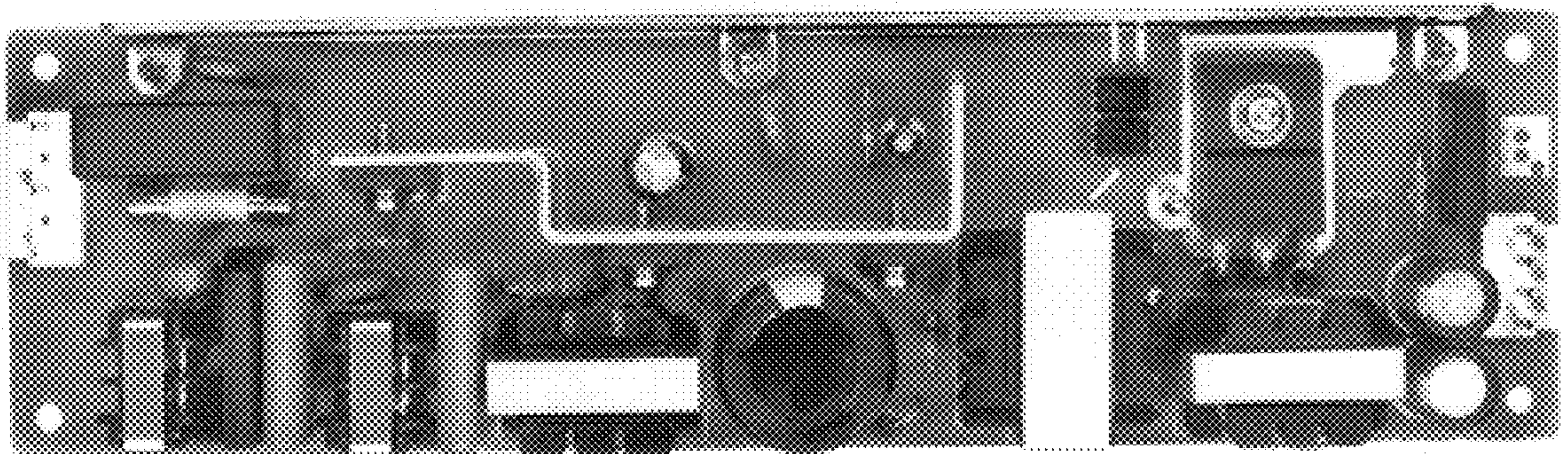

FIG. 3

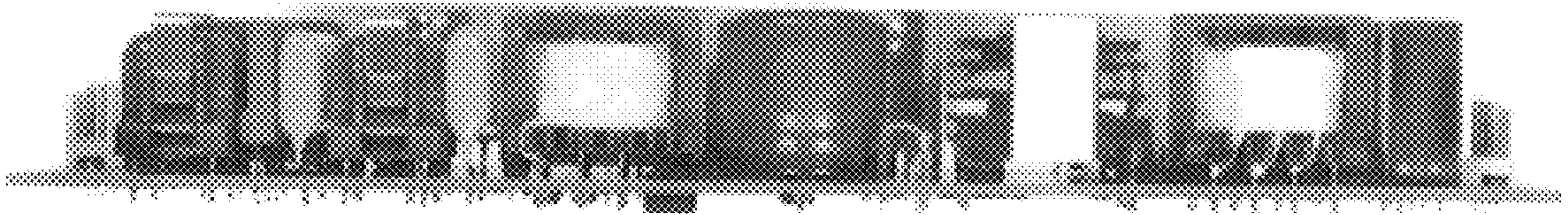

FIG. 4

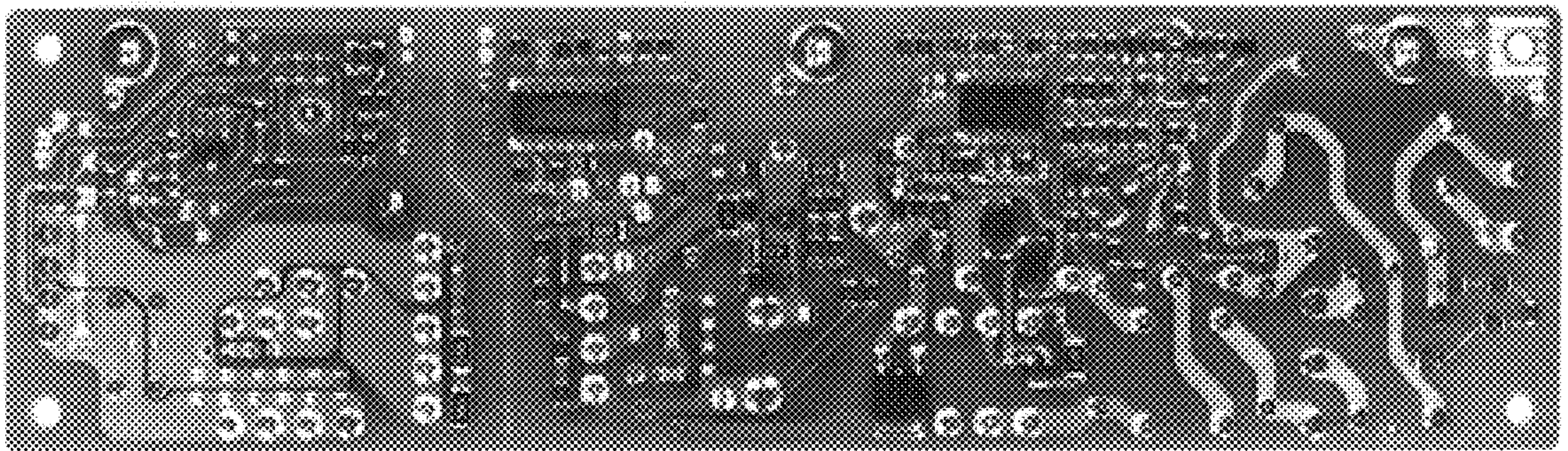

FIG. 5

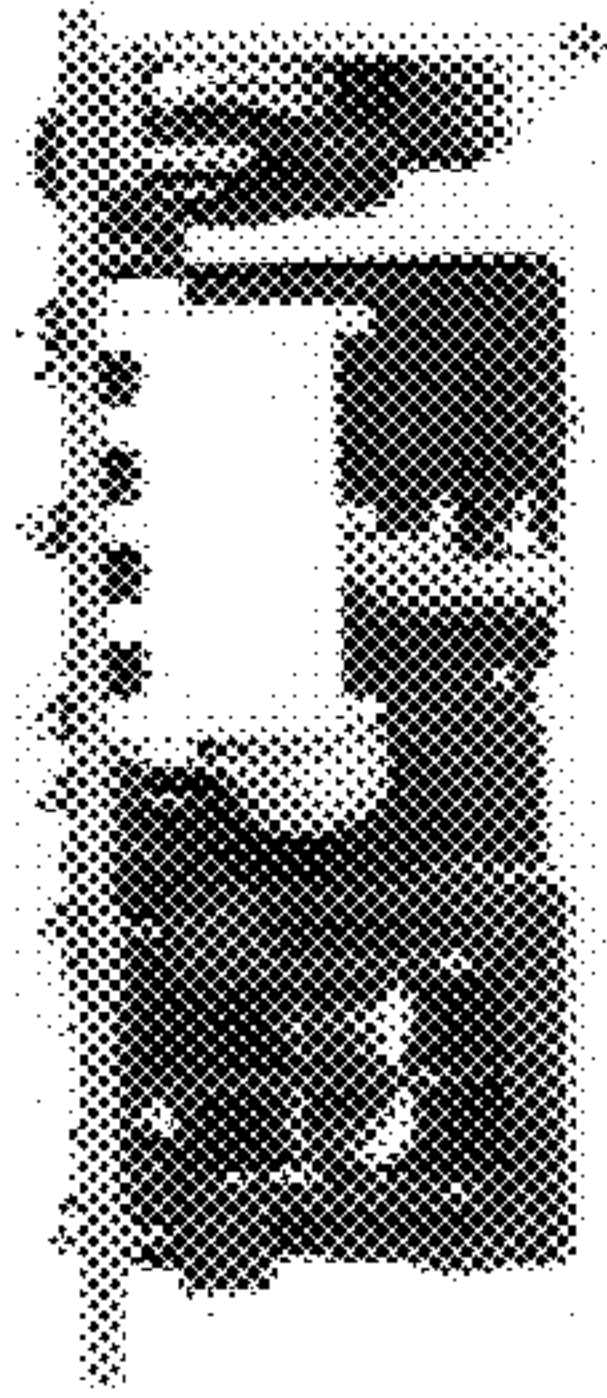

FIG. 6

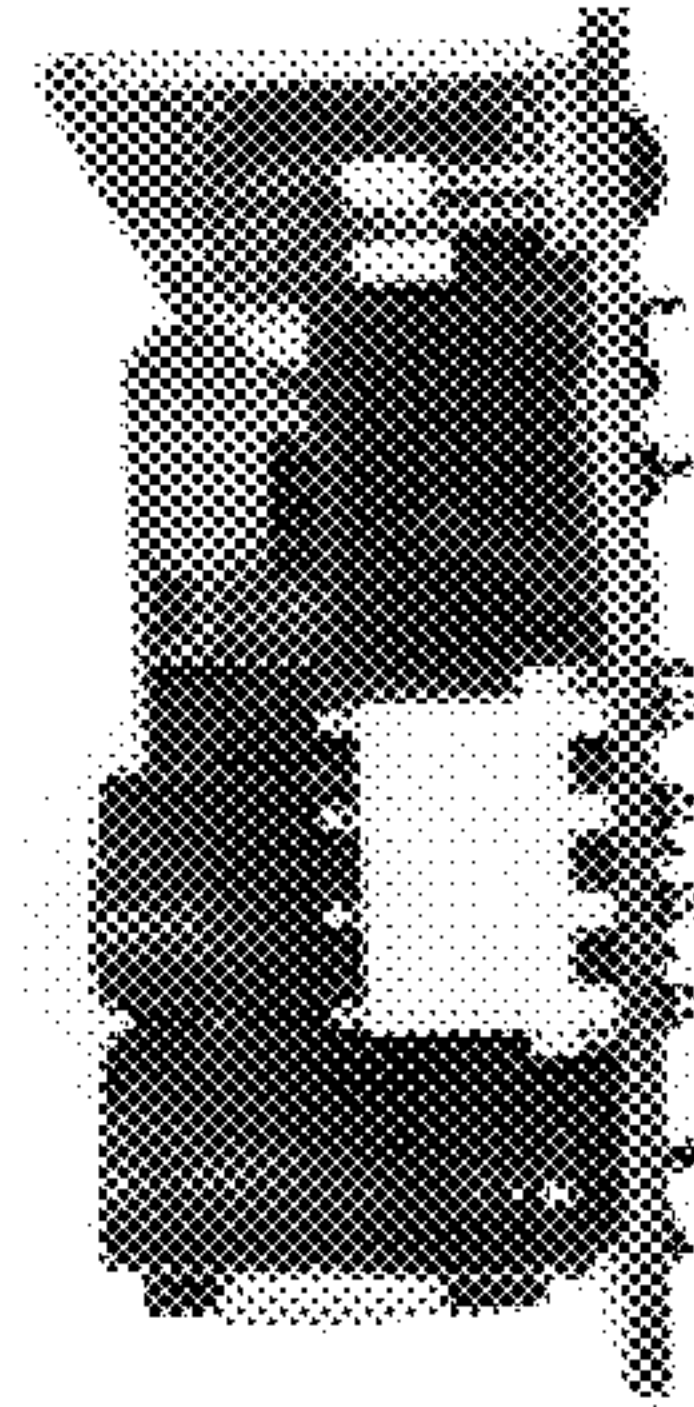

FIG. 7

