



US00D428384S

United States Patent [19]
Maeyama

[11] **Patent Number: Des. 428,384**
[45] **Date of Patent: ** Jul. 18, 2000**

[54] **RECHARGEABLE BATTERY**

OTHER PUBLICATIONS

[75] Inventor: **Kouichi Maeyama**, Tokyo, Japan

Sony Catalog "63", pp. 12-16, 18 and 19, (Mar., 1998).

[73] Assignee: **Sony Corporation**, Japan

Primary Examiner—Joel Sincavage
Attorney, Agent, or Firm—Rader, Fishman & Grauer

[**] Term: **14 Years**

[57] **CLAIM**

[21] Appl. No.: **29/110,001**

The ornamental design for a rechargeable battery, as shown and described.

[22] Filed: **Aug. 23, 1999**

DESCRIPTION

Related U.S. Application Data

[63] Continuation of application No. 29/088,709, May 29, 1998, and a continuation of application No. 29/088,710, May 29, 1998.

FIG. 1 is a perspective view of a first embodiment of a rechargeable battery showing my new design;

[51] **LOC (7) Cl.** **13-02**

FIG. 2 is a top plan view thereof;

[52] **U.S. Cl.** **D13/103**

FIG. 3 is a left side elevational view thereof;

[58] **Field of Search** D13/103; 429/96-100,
429/159, 163, 176

FIG. 4 is a front elevational view thereof;

FIG. 5 is a bottom plan view thereof;

FIG. 6 is a right side elevational view thereof; and

FIG. 7 is a rear elevational view thereof.

FIG. 8 is a perspective view of a second embodiment of a rechargeable battery showing my new design;

FIG. 9 is a top plan view thereof;

FIG. 10 is a left side elevational view thereof;

FIG. 11 is a front elevational view thereof;

FIG. 12 is a bottom plan view thereof;

FIG. 13 is a right side elevational view thereof; and

FIG. 14 is a rear elevational view thereof.

FIG. 15 is a perspective view of a third embodiment of a rechargeable battery showing my new design;

FIG. 16 is a top plan view thereof;

FIG. 17 is a left side elevational view thereof;

FIG. 18 is a front elevational view thereof;

FIG. 19 is a bottom plan view thereof;

FIG. 20 is a right side elevational view thereof; and

FIG. 21 is a rear elevational view thereof.

FIG. 22 is a perspective view of a fourth embodiment of a rechargeable battery showing my new design;

FIG. 23 is a top plan view thereof;

FIG. 24 is a left side elevational view thereof;

FIG. 25 is a front elevational view thereof;

FIG. 26 is a bottom plan view thereof;

FIG. 27 is a right side elevational view thereof; and

FIG. 28 is a rear elevational view thereof.

FIG. 29 is a perspective view of a fifth embodiment of a rechargeable battery showing my new design;

[56] **References Cited**

U.S. PATENT DOCUMENTS

| | | | | |
|------------|---------|------------------|-------|-----------|
| D. 250,529 | 12/1978 | Kaye | | D13/8 |
| D. 356,776 | 3/1995 | Yoshii | | D13/103 |
| D. 362,424 | 9/1995 | Sumita et al. | | D13/103 |
| D. 377,477 | 1/1997 | Harata et al. | | D13/103 |
| D. 403,656 | 1/1999 | Ichikawa | | D13/103 |
| 5,281,990 | 1/1994 | Huang | | 354/484 |
| 5,306,576 | 4/1994 | Sasaki | | 429/98 |
| 5,399,446 | 3/1995 | Takahashi | | 429/90 |
| 5,415,947 | 5/1995 | Mitsui et al. | | 429/1 |
| 5,437,938 | 8/1995 | Mitsui et al. | | 429/176 X |
| 5,602,454 | 2/1997 | Arakawa et al. | | 429/97 X |
| 5,608,612 | 3/1997 | Hokao | | 439/97 X |
| 5,626,979 | 5/1997 | Mitsui et al. | | 429/97 |
| 5,672,441 | 9/1997 | Aoki et al. | | 429/97 |
| 5,824,431 | 10/1998 | Tsurumaru et al. | | 429/97 |

FOREIGN PATENT DOCUMENTS

| | | |
|-----------|---------|---------|
| 5-335036 | 12/1993 | Japan . |
| 6-20665 | 1/1994 | Japan . |
| 6-104017 | 4/1994 | Japan . |
| 9-271144 | 10/1997 | Japan . |
| 10-312782 | 11/1998 | Japan . |

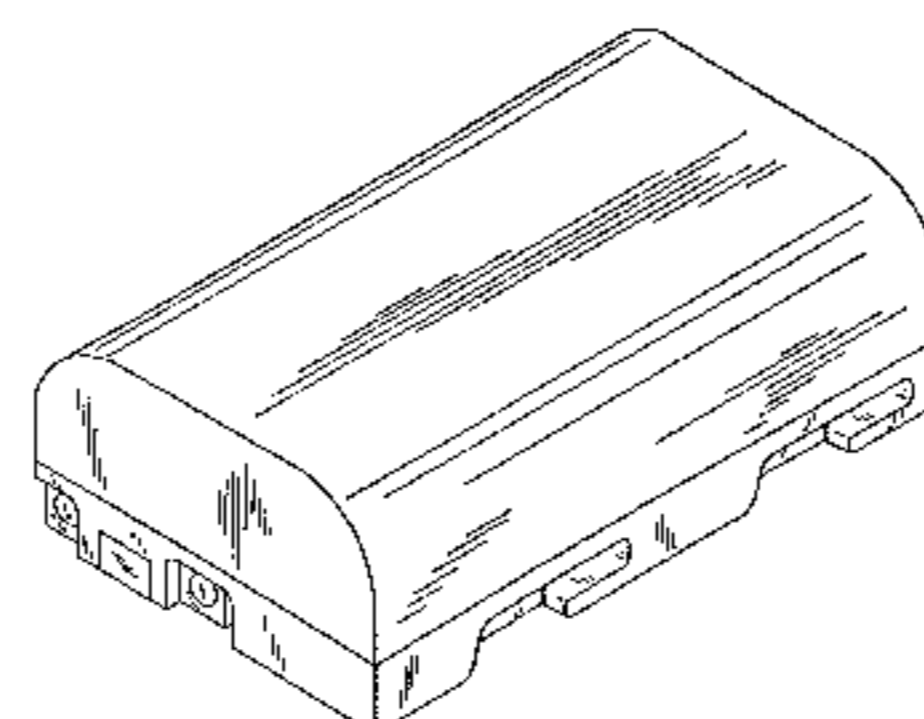
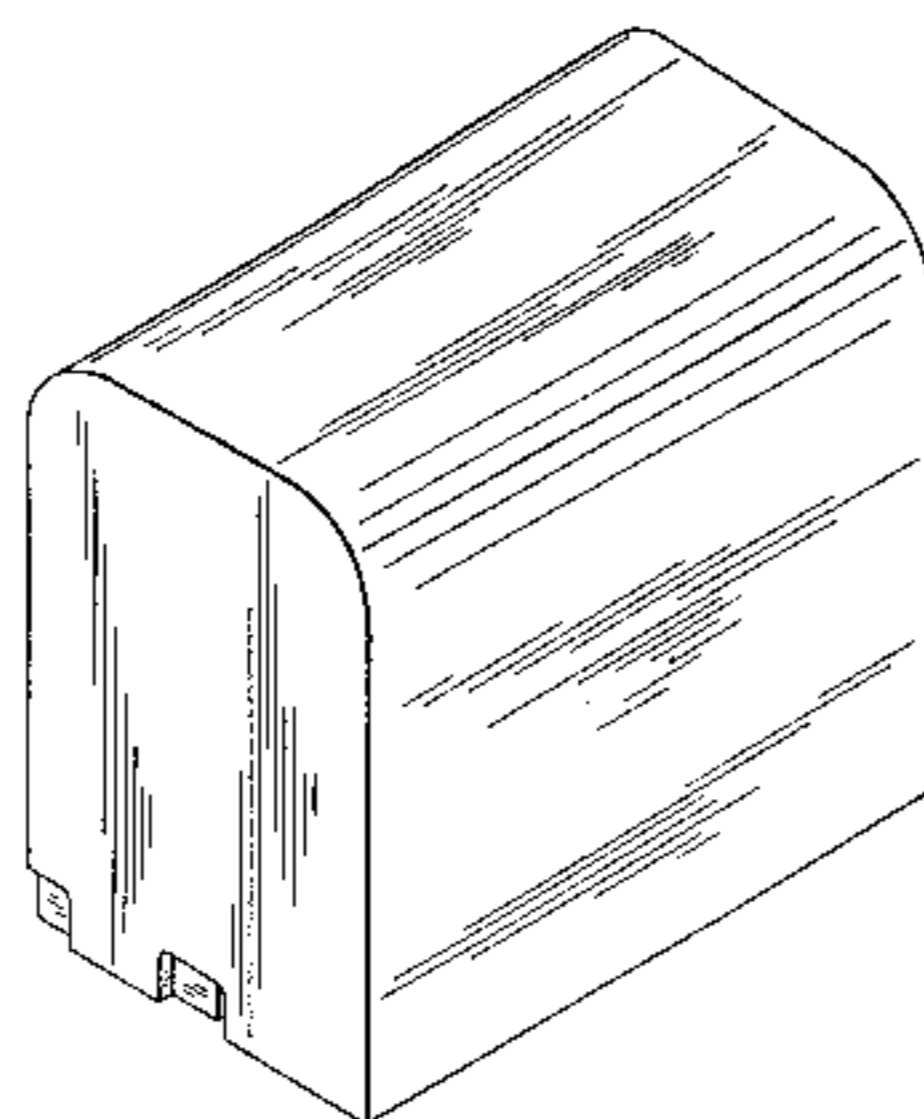

FIG. 30 is a top plan view thereof;
FIG. 31 is a left side elevational view thereof;
FIG. 32 is a front elevational view thereof;
FIG. 33 is a bottom plan view thereof;
FIG. 34 is a right side elevational view thereof; and
FIG. 35 is a rear elevational view thereof.
FIG. 36 is a perspective view of a sixth embodiment of a rechargeable battery showing my new design;
FIG. 37 is a top plan view thereof;
FIG. 38 is a left side elevational view thereof;
FIG. 39 is a front elevational view thereof;
FIG. 40 is a bottom plan view thereof;
FIG. 41 is a right side elevational view thereof; and
FIG. 42 is a rear elevational view thereof.
FIG. 43 is a perspective view of a seventh embodiment of a rechargeable battery showing my new design;
FIG. 44 is a top plan view thereof;
FIG. 45 is a left side elevational view thereof;
FIG. 46 is a front elevational view thereof;
FIG. 47 is a bottom plan view thereof;
FIG. 48 is a right side elevational view thereof; and
FIG. 49 is a rear elevational view thereof.

FIG. 50 is a perspective view of a eighth embodiment of a rechargeable battery showing my new design;
FIG. 51 is a top plan view thereof;
FIG. 52 is a left side elevational view thereof;
FIG. 53 is a front elevational view thereof;
FIG. 54 is a bottom plan view thereof;
FIG. 55 is a right side elevational view thereof; and
FIG. 56 is a rear elevational view thereof.
FIG. 57 is a perspective view of a ninth embodiment of a rechargeable battery showing my new design;
FIG. 58 is a top plan view thereof;
FIG. 59 is a left side elevational view thereof;
FIG. 60 is a front elevational view thereof;
FIG. 61 is a bottom plan view thereof;
FIG. 62 is a right side elevational view thereof; and,
FIG. 63 is a rear elevational view thereof.
The entire contents of design patent application Ser. Nos. 29/088,709 and 29/088,710 both filed May 29, 1998 including drawing descriptions and drawings are incorporated herein by reference.

1 Claim, 36 Drawing Sheets

FIG. 1

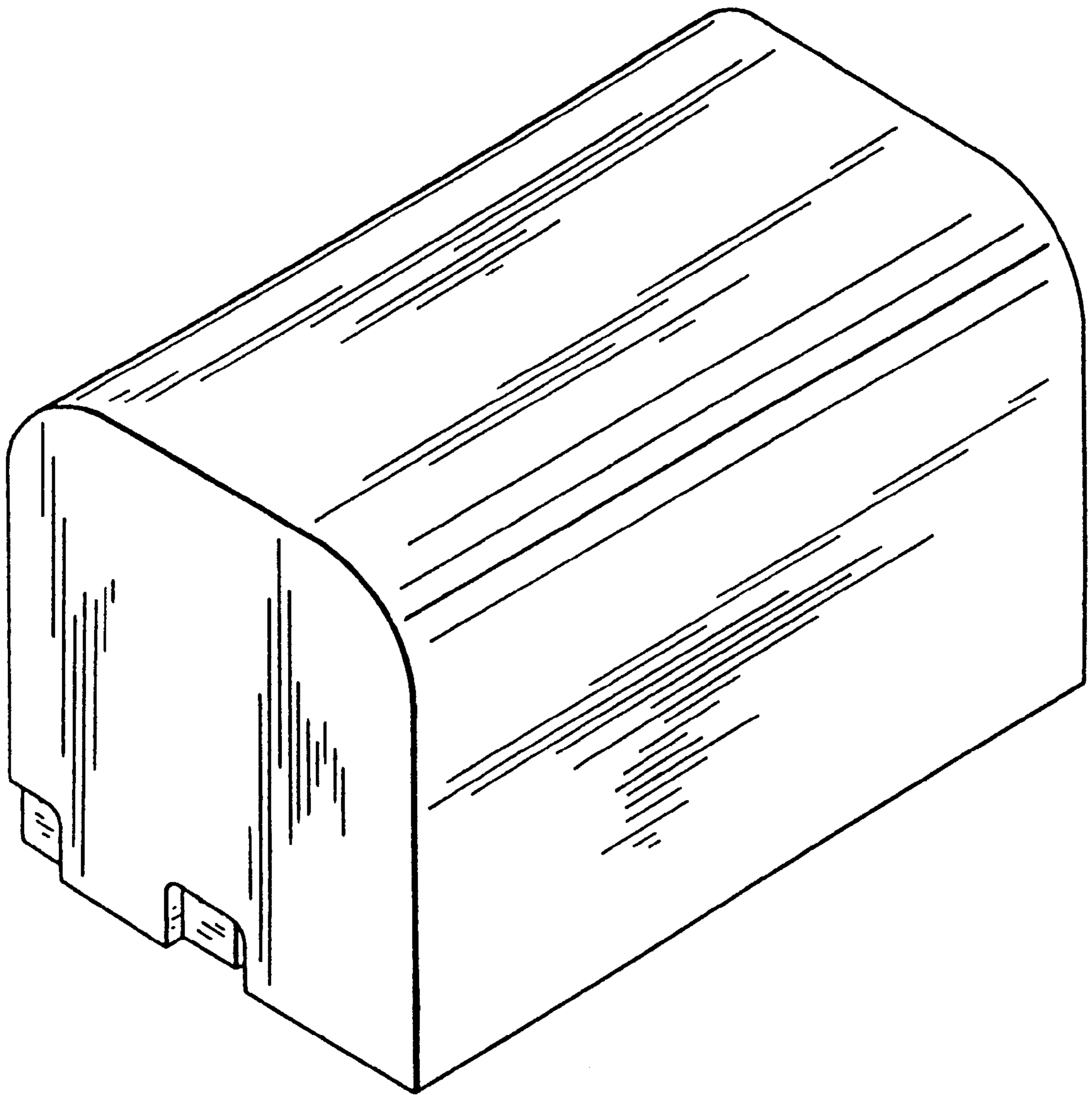

FIG. 2

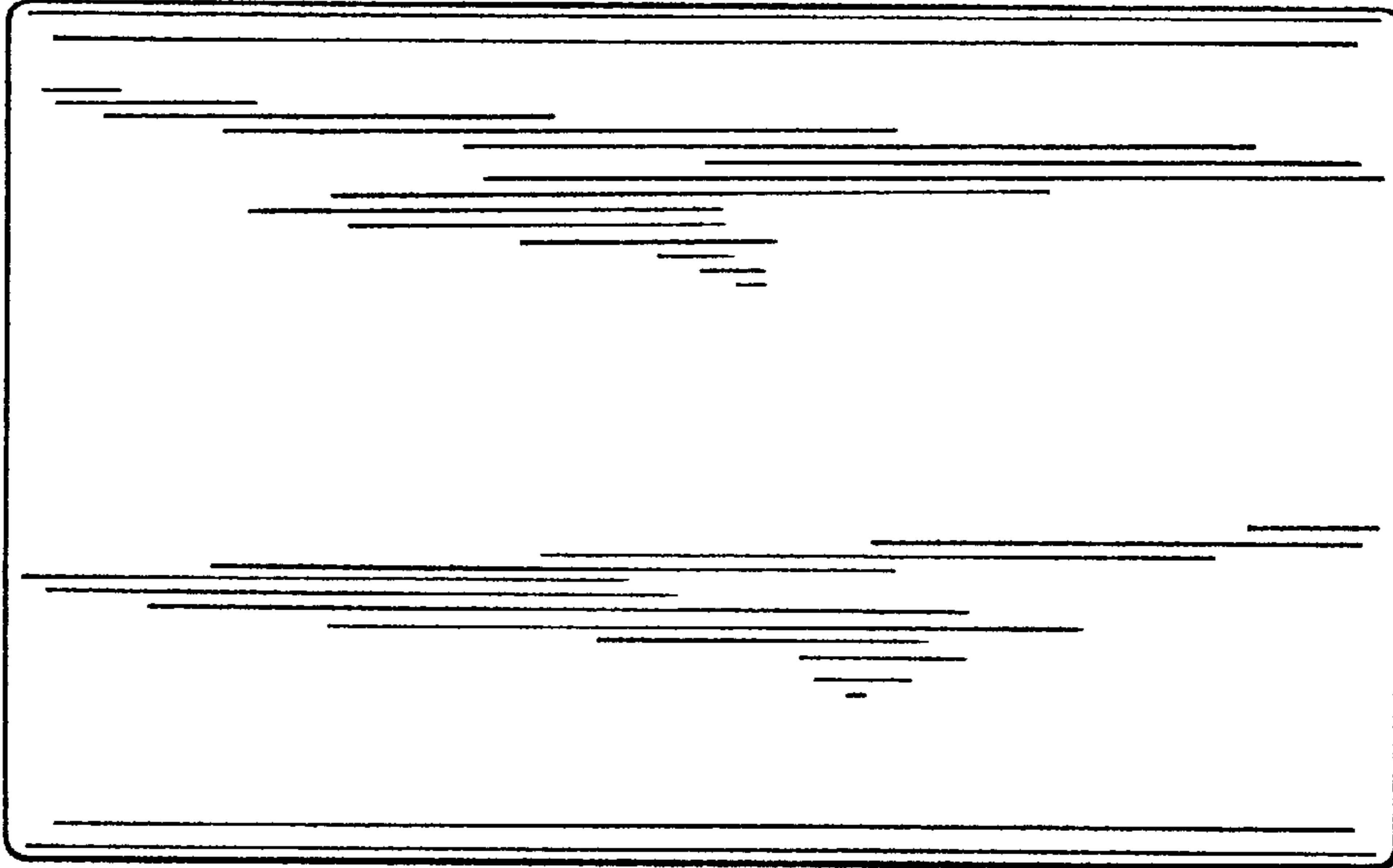

FIG. 5

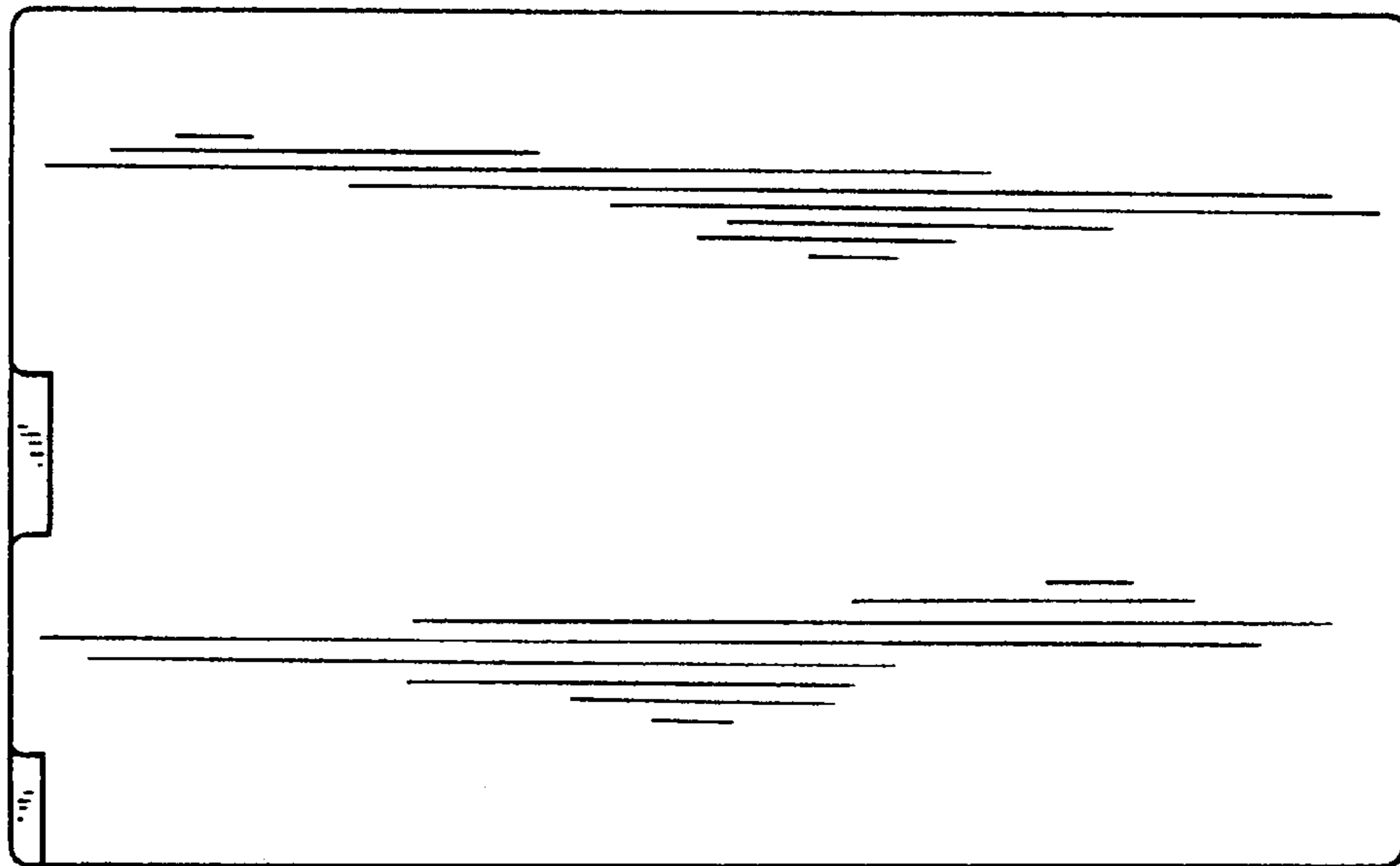

FIG. 3

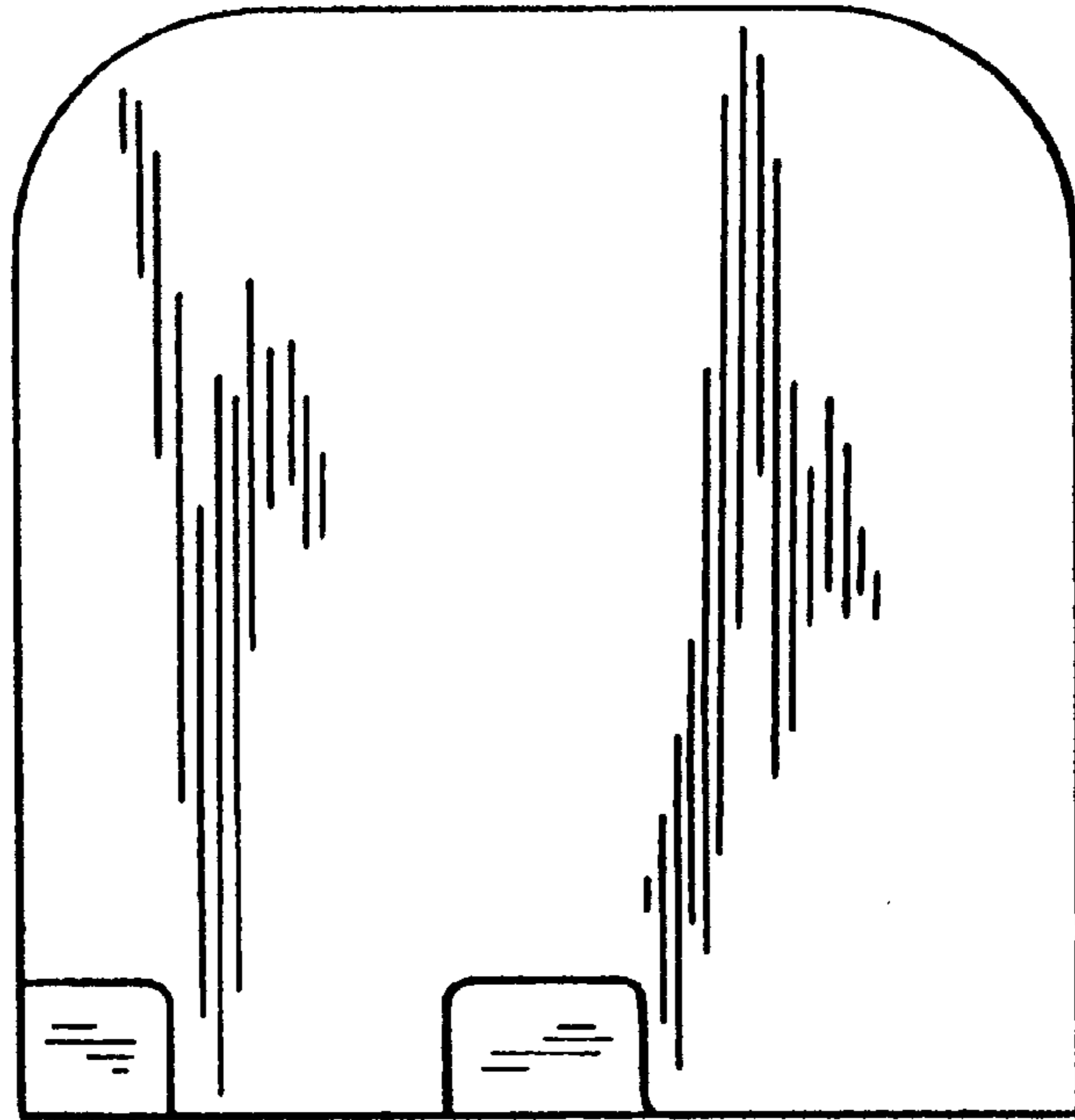

FIG. 6



FIG. 4

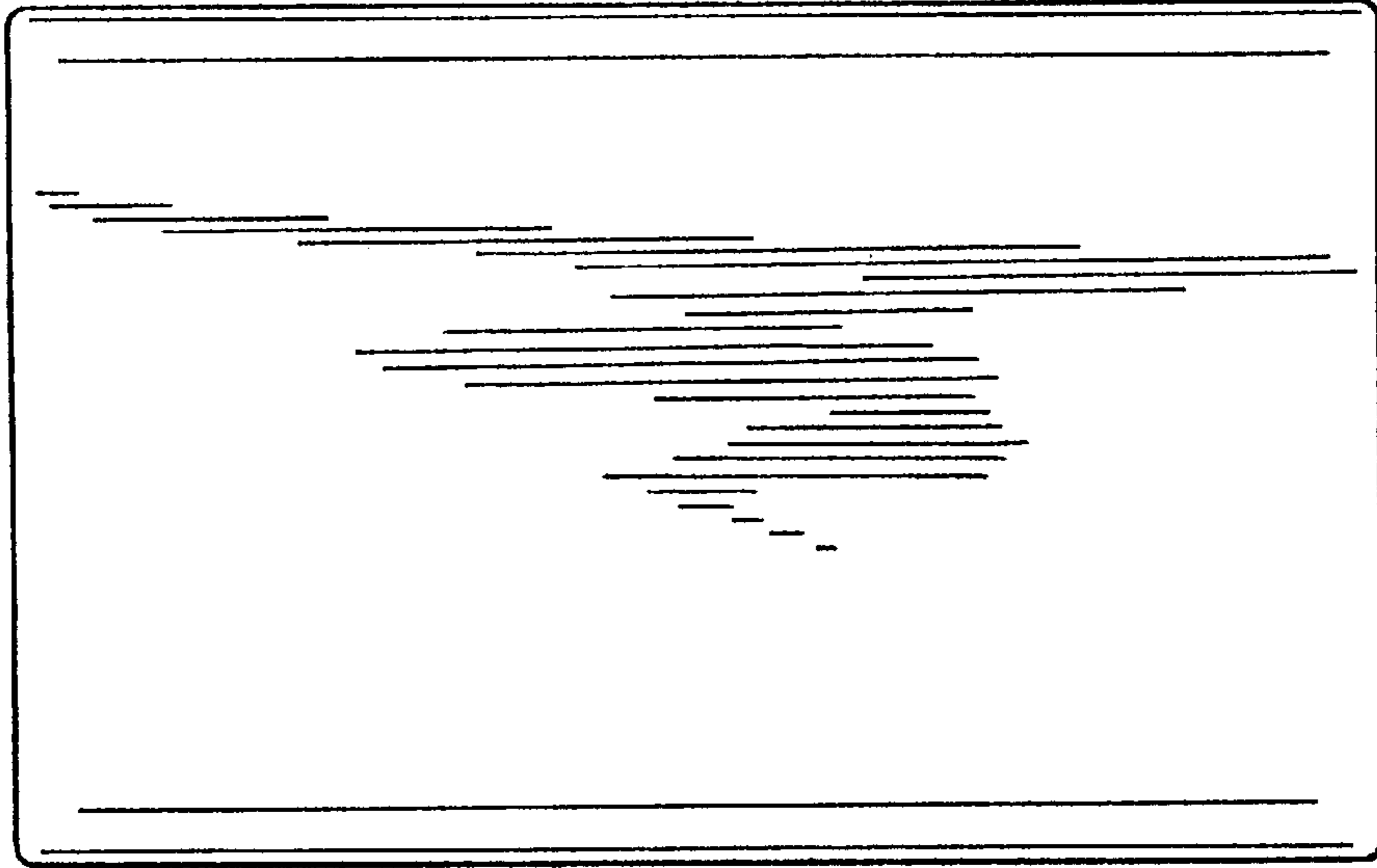

FIG. 7

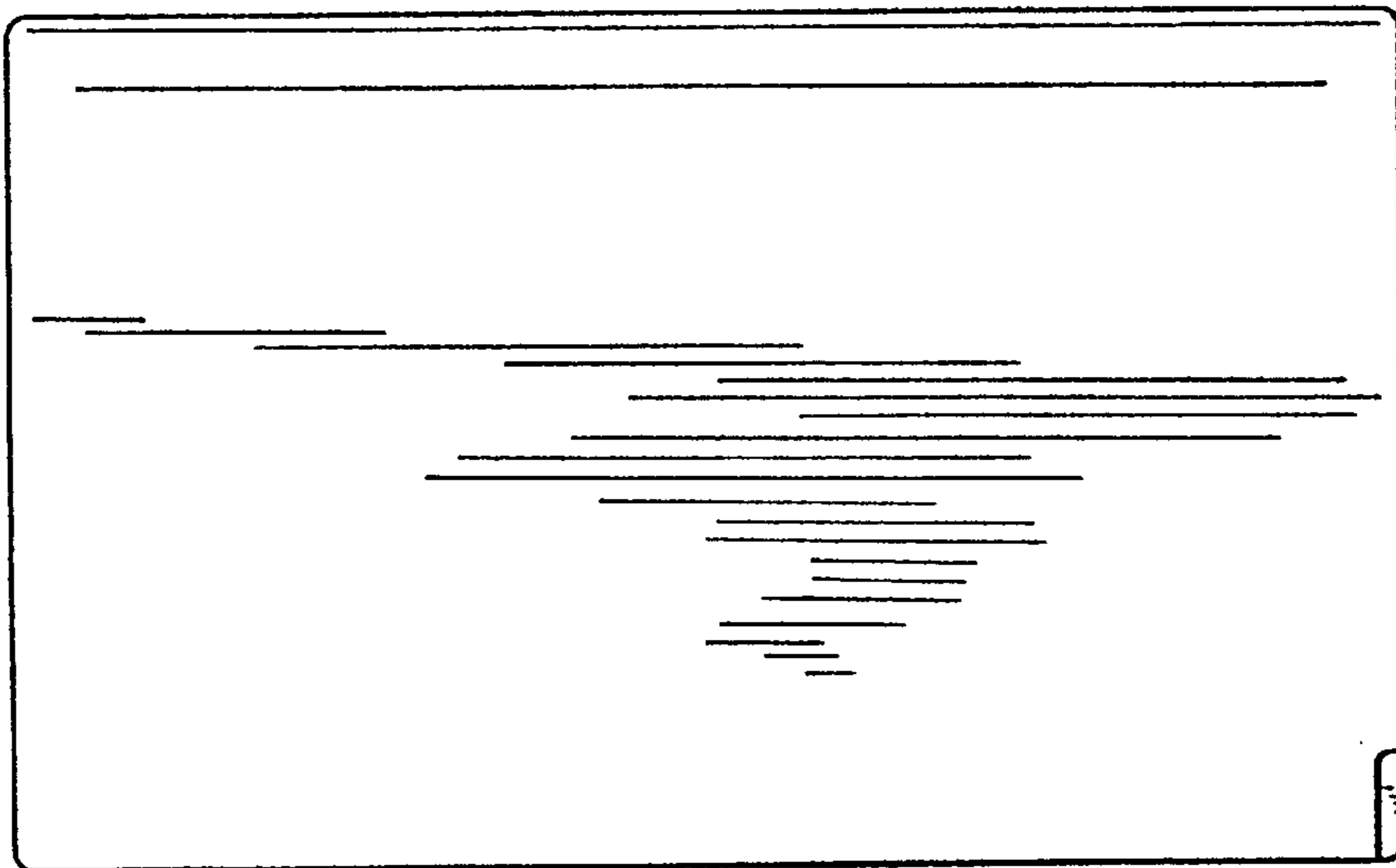

FIG. 8

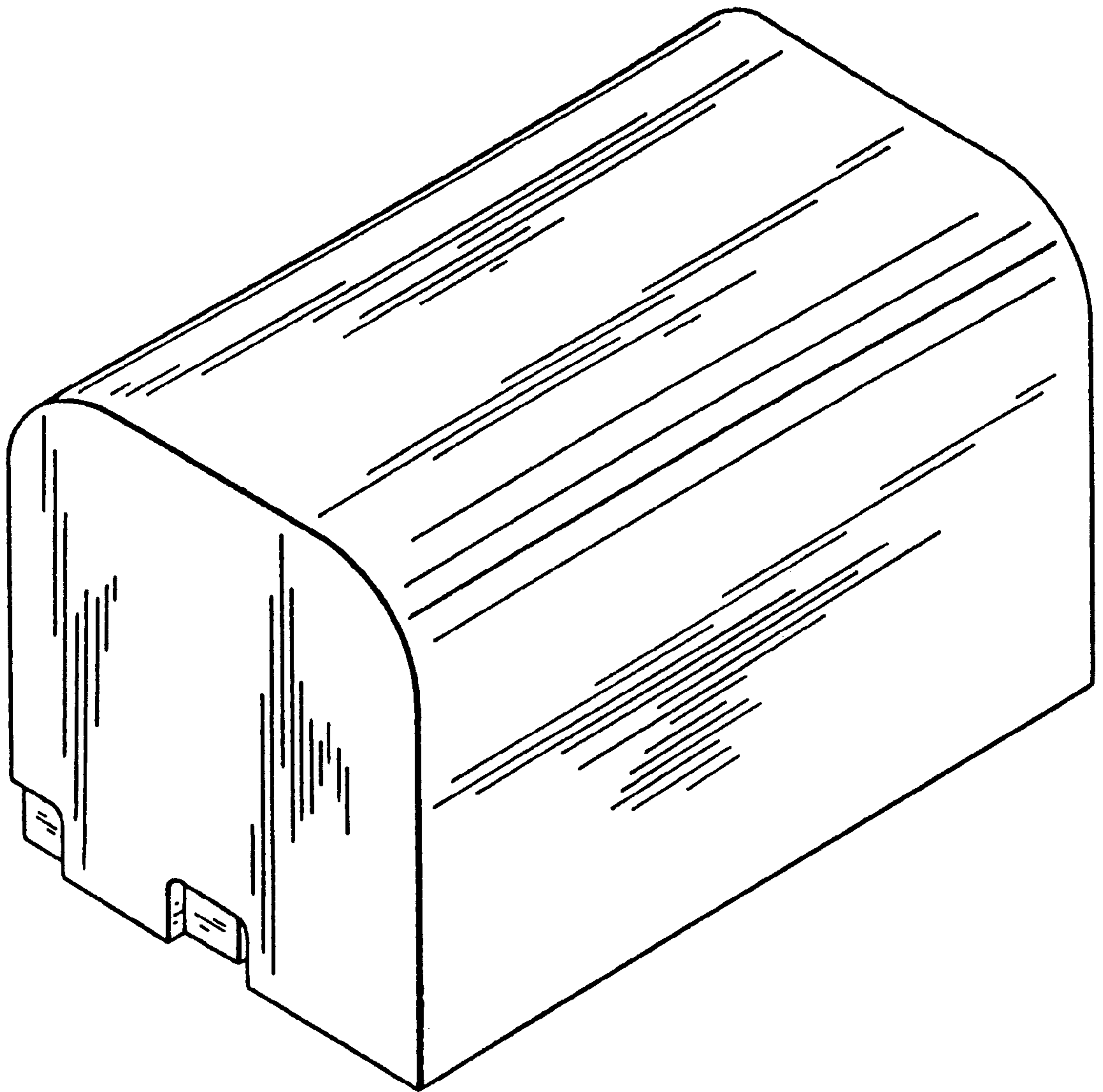

FIG. 9

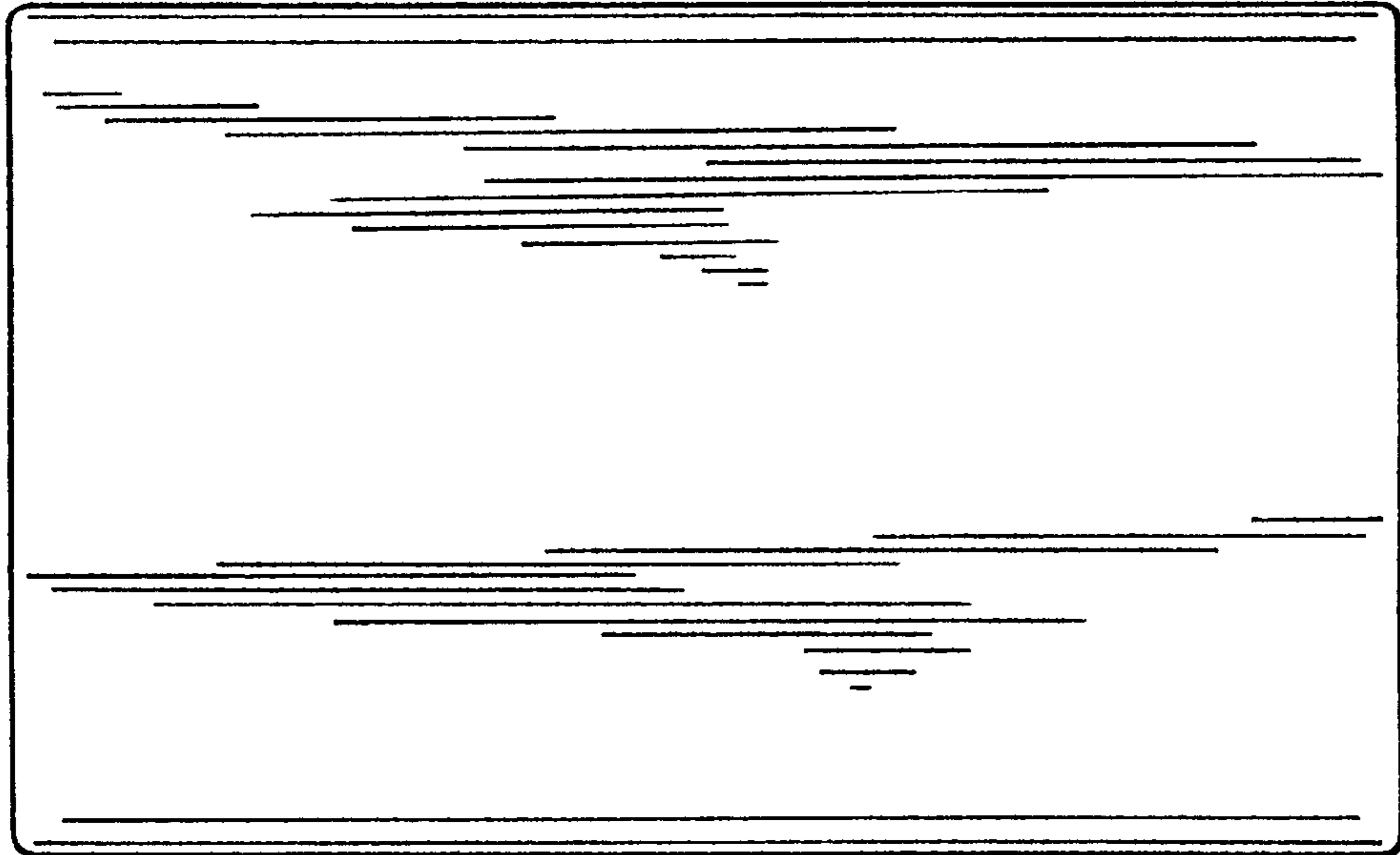

FIG. 12

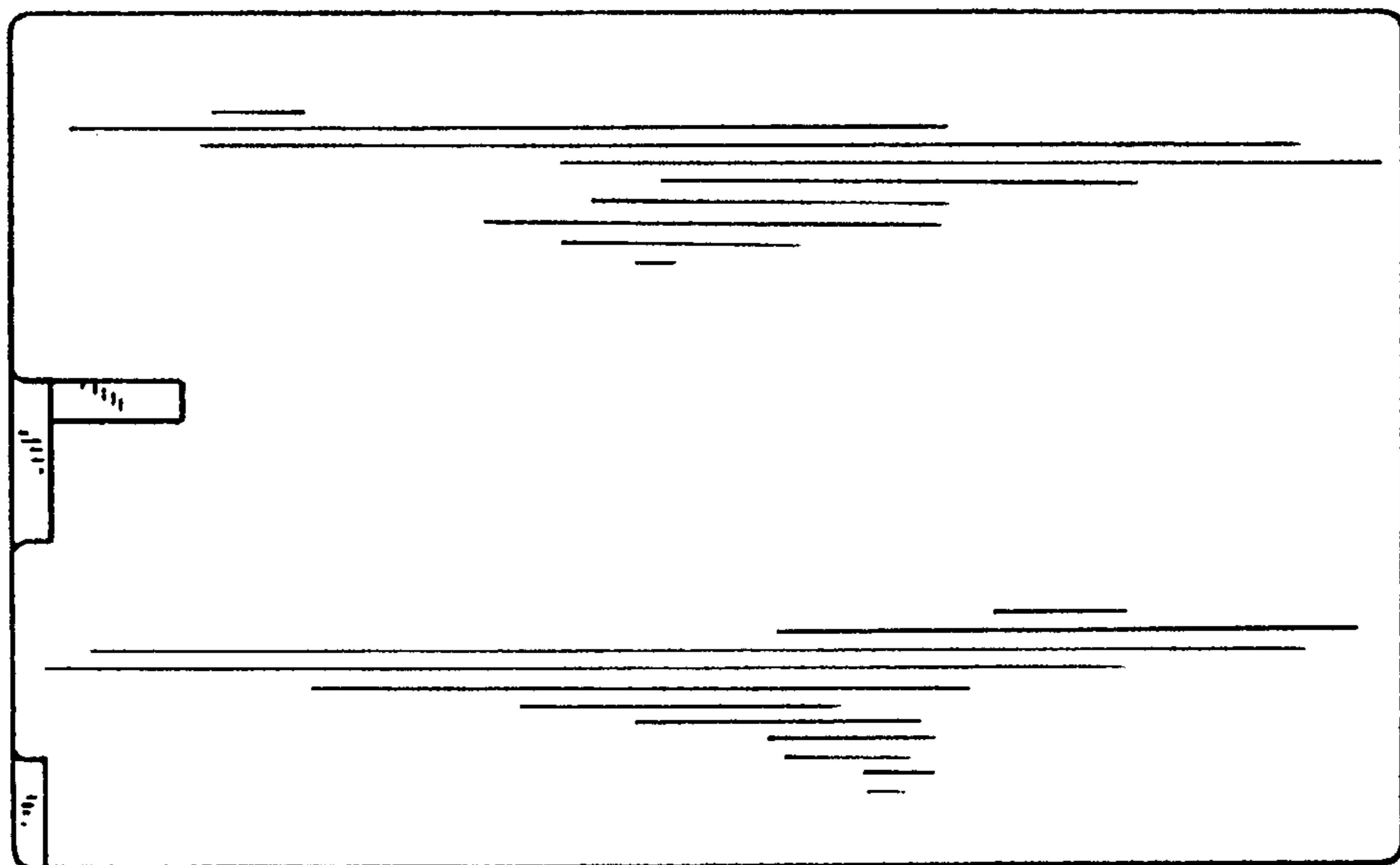

FIG. 10

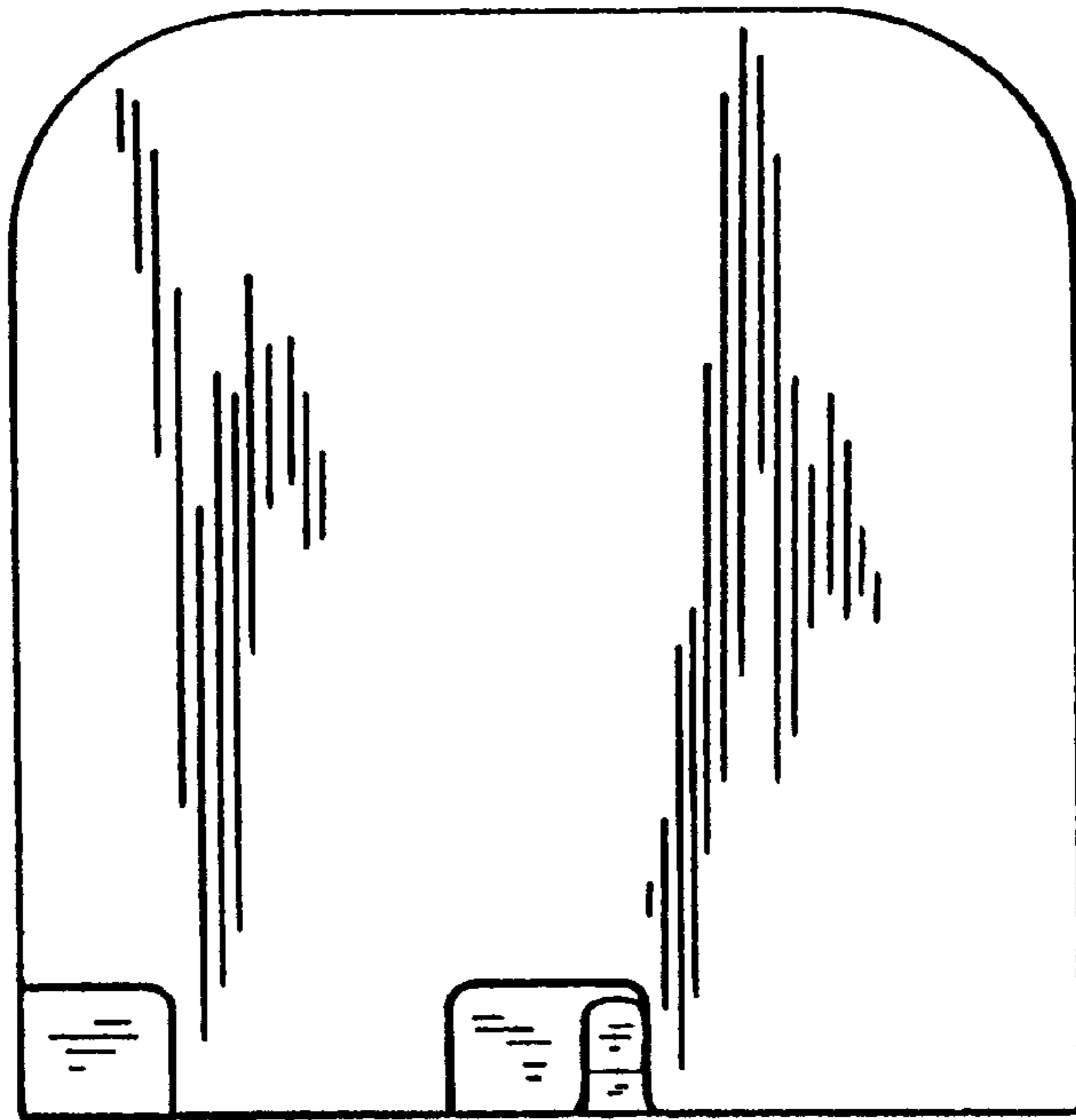

FIG. 13



FIG. 11

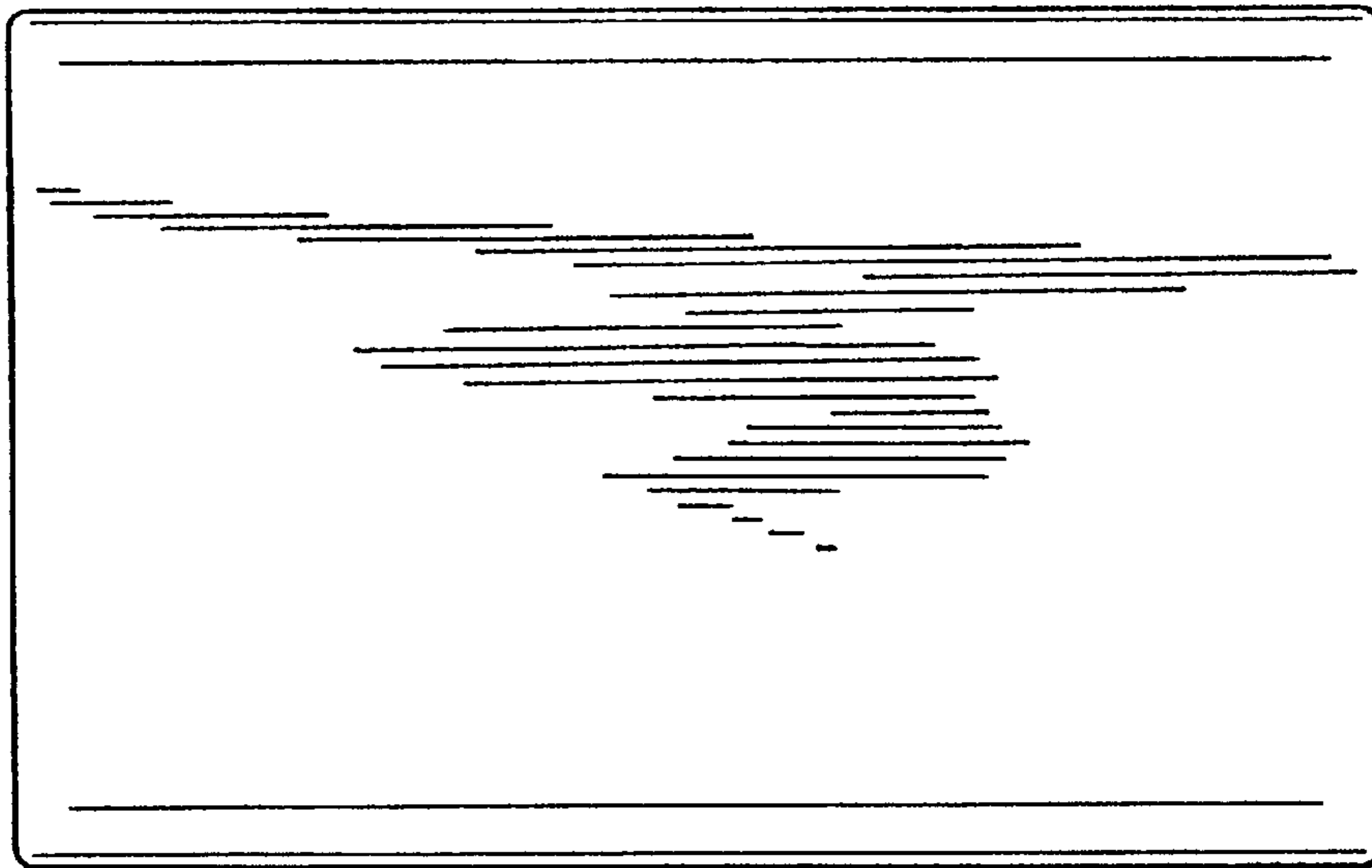

FIG. 14

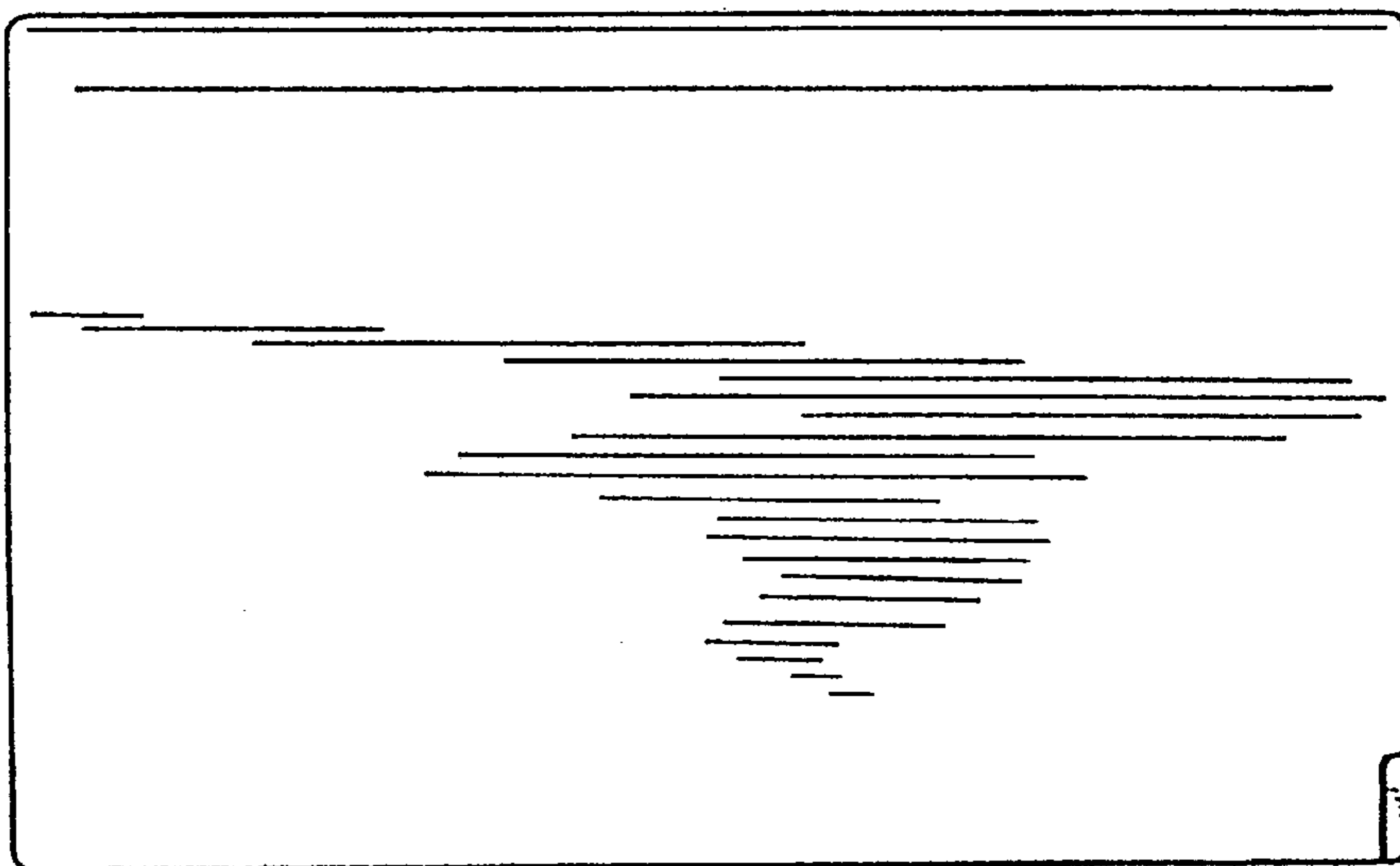

FIG. 15

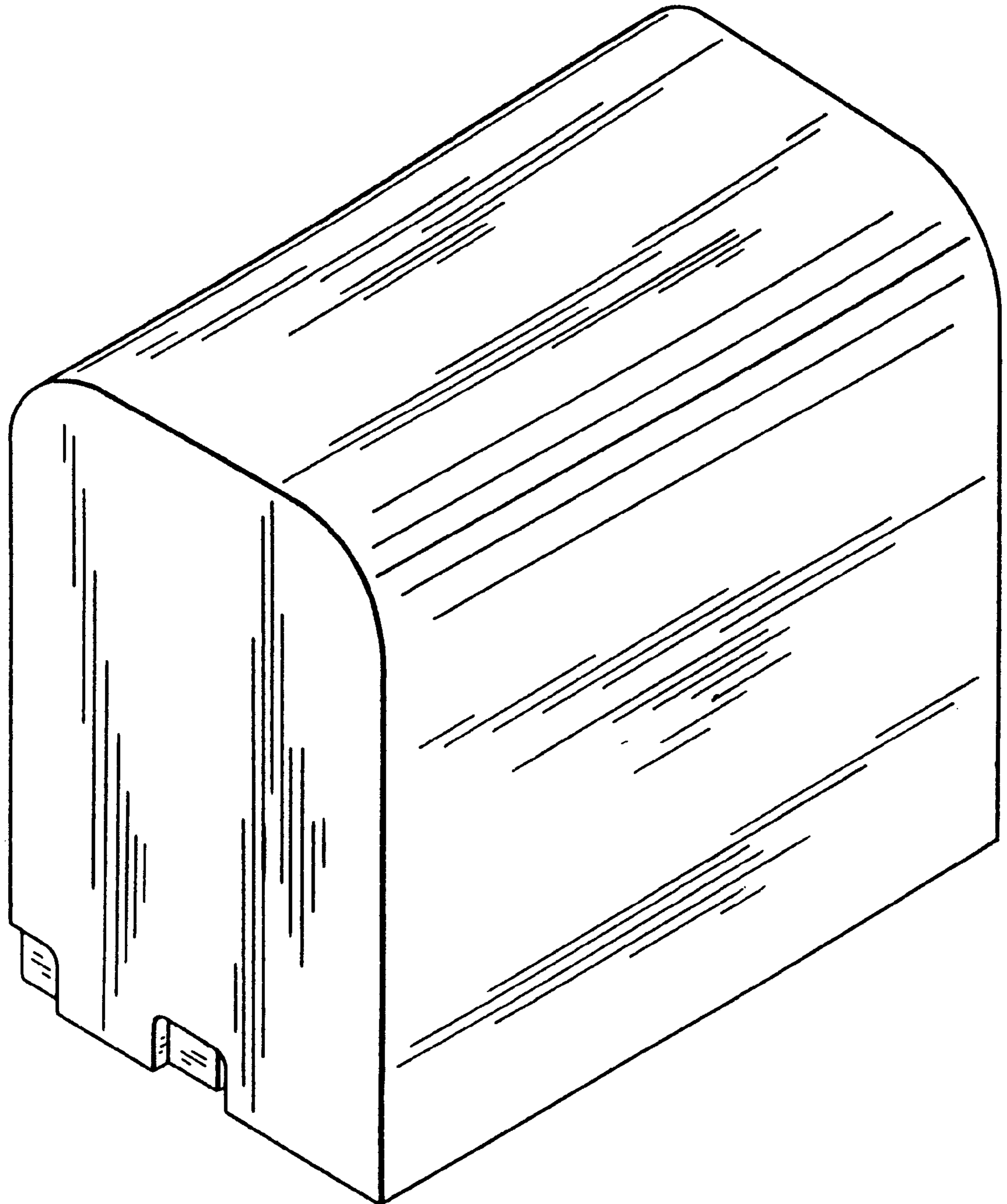

FIG. 16

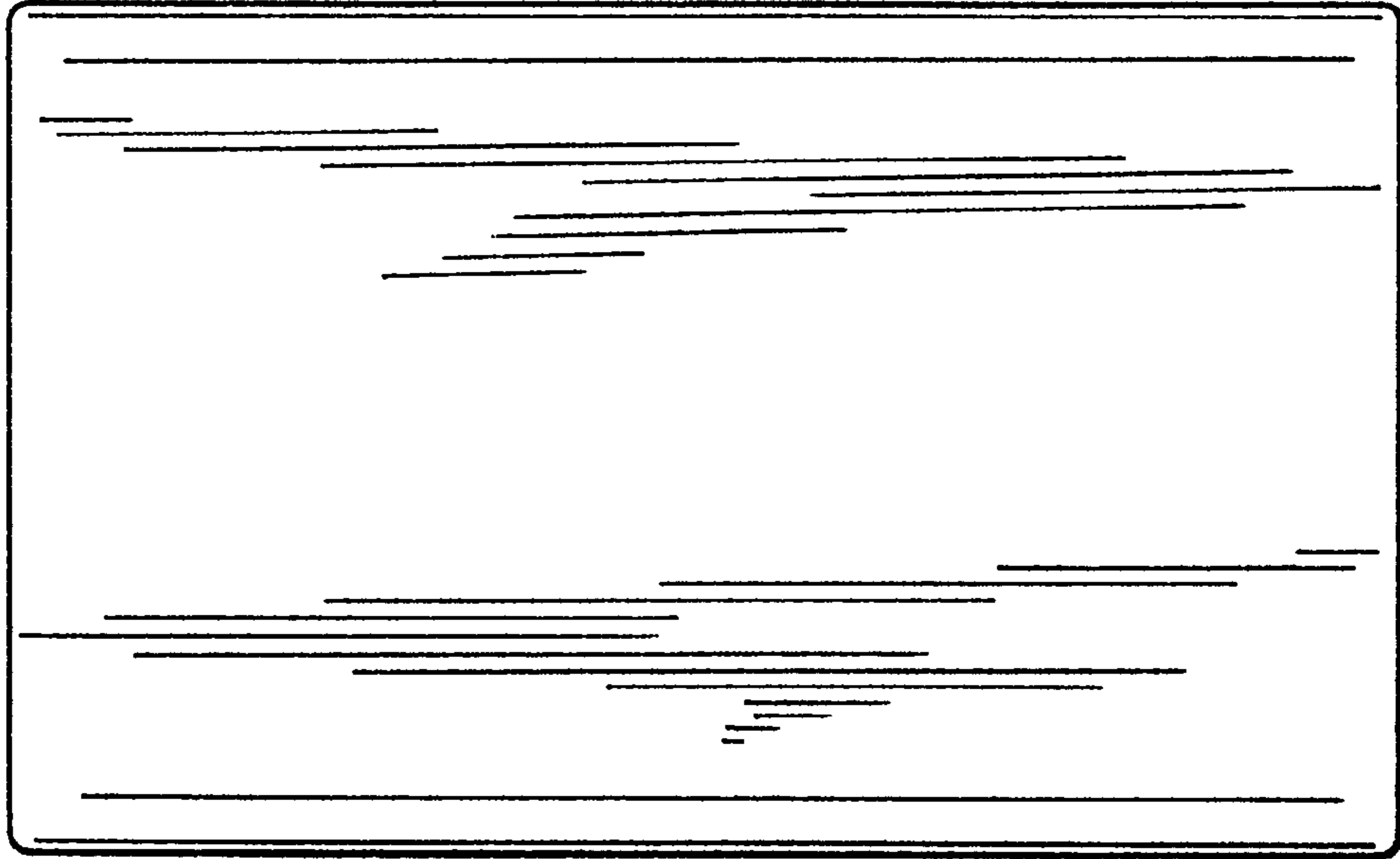

FIG. 19

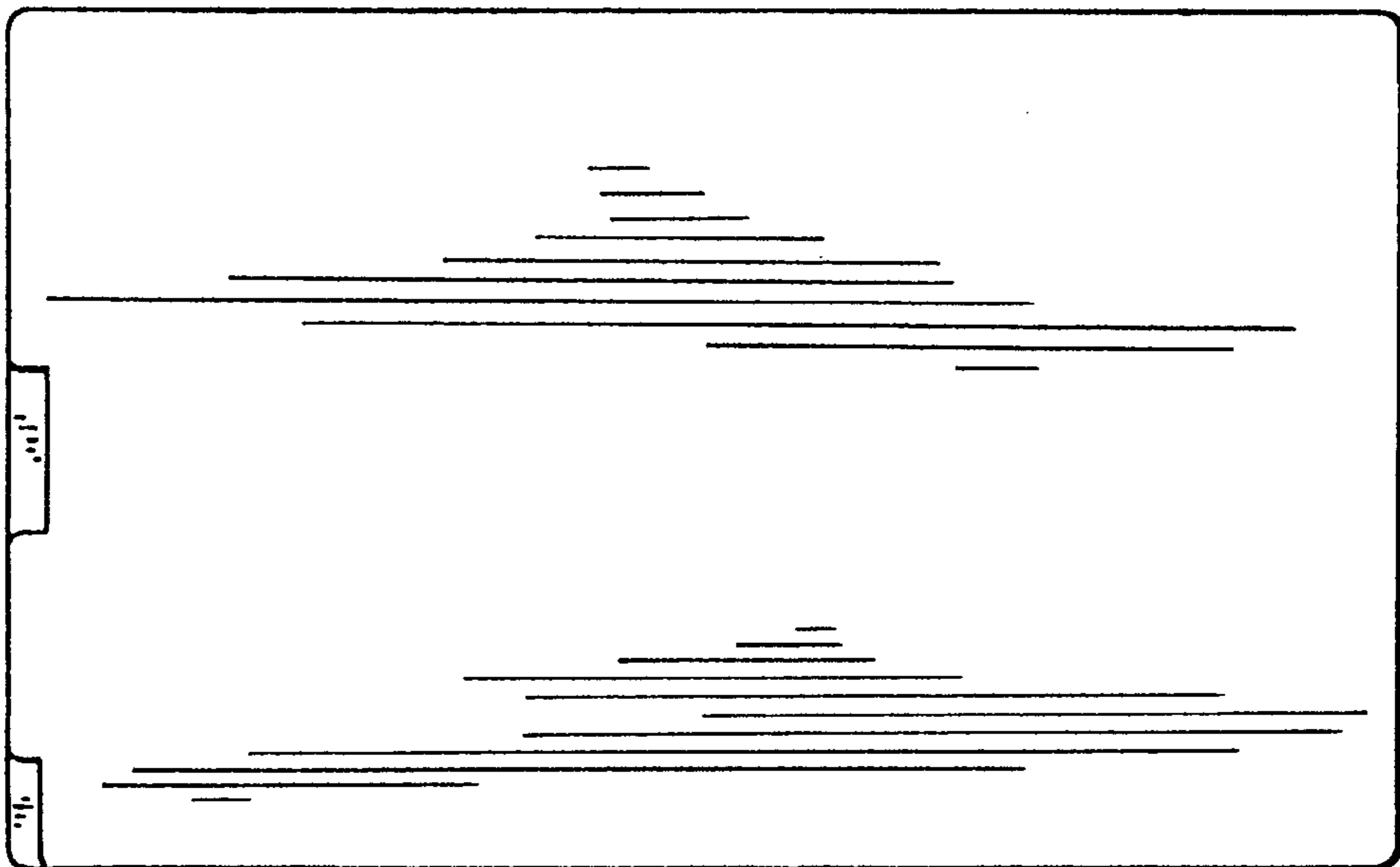

FIG. 17

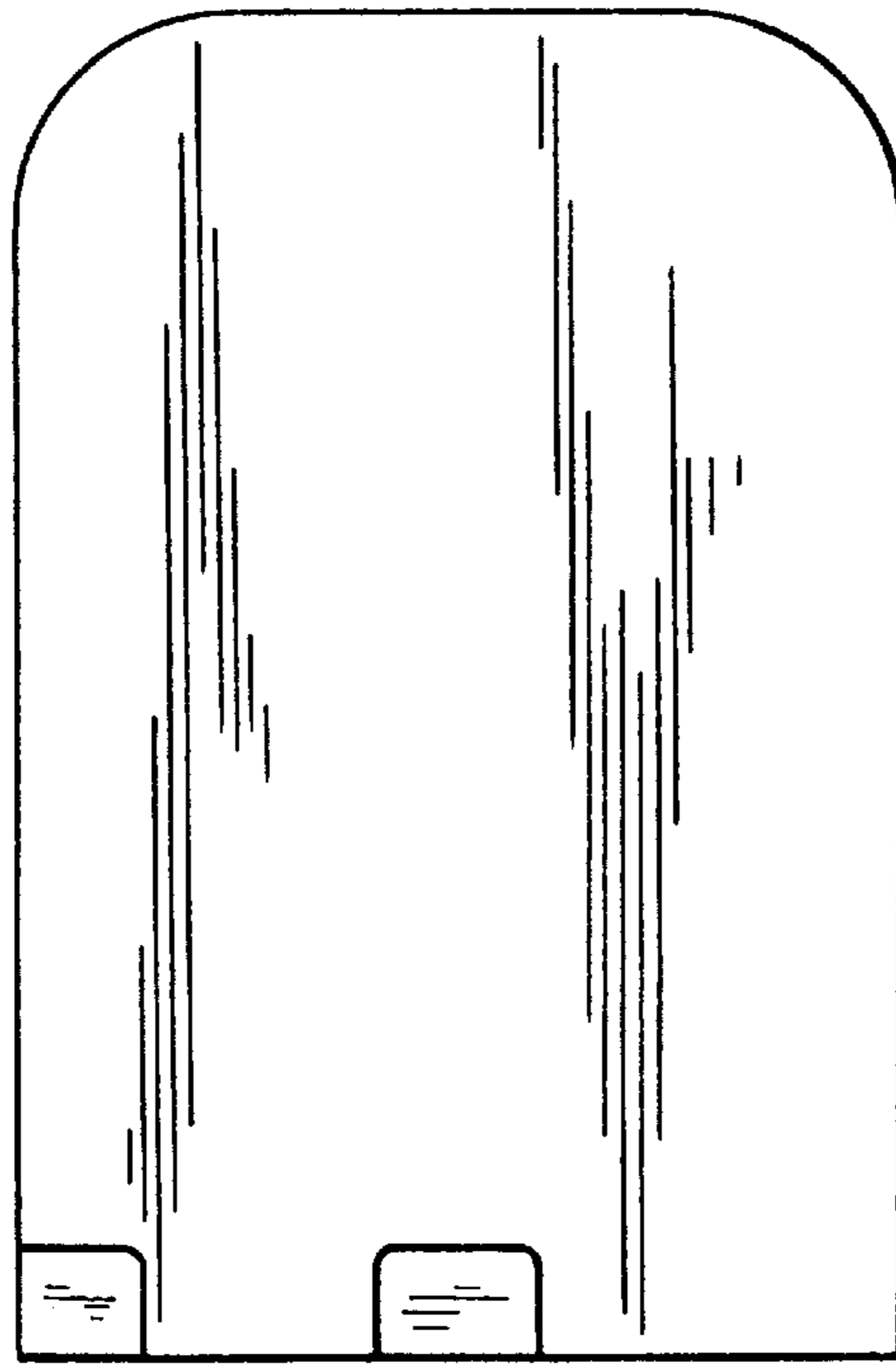

FIG. 20

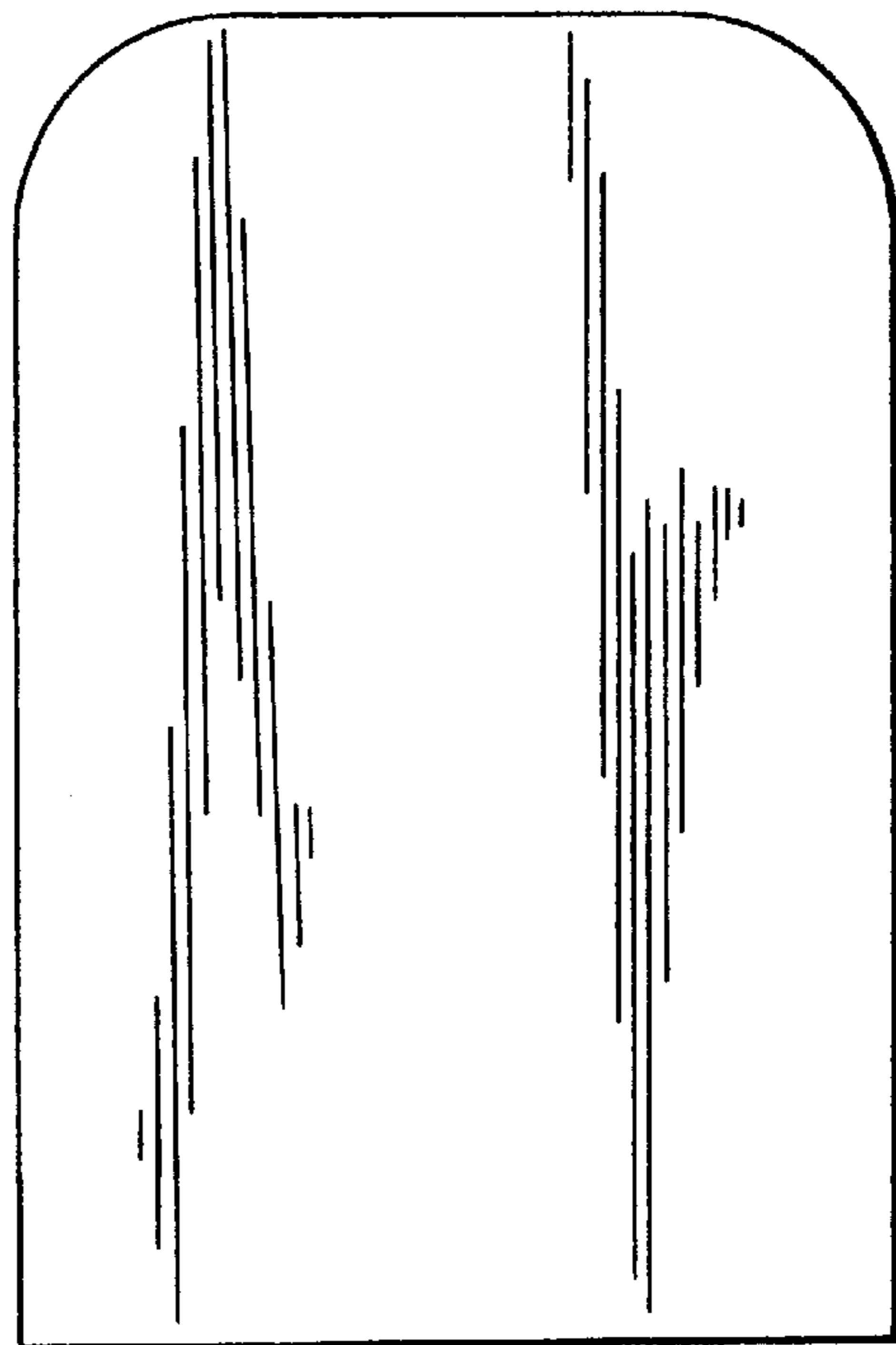

FIG. 18

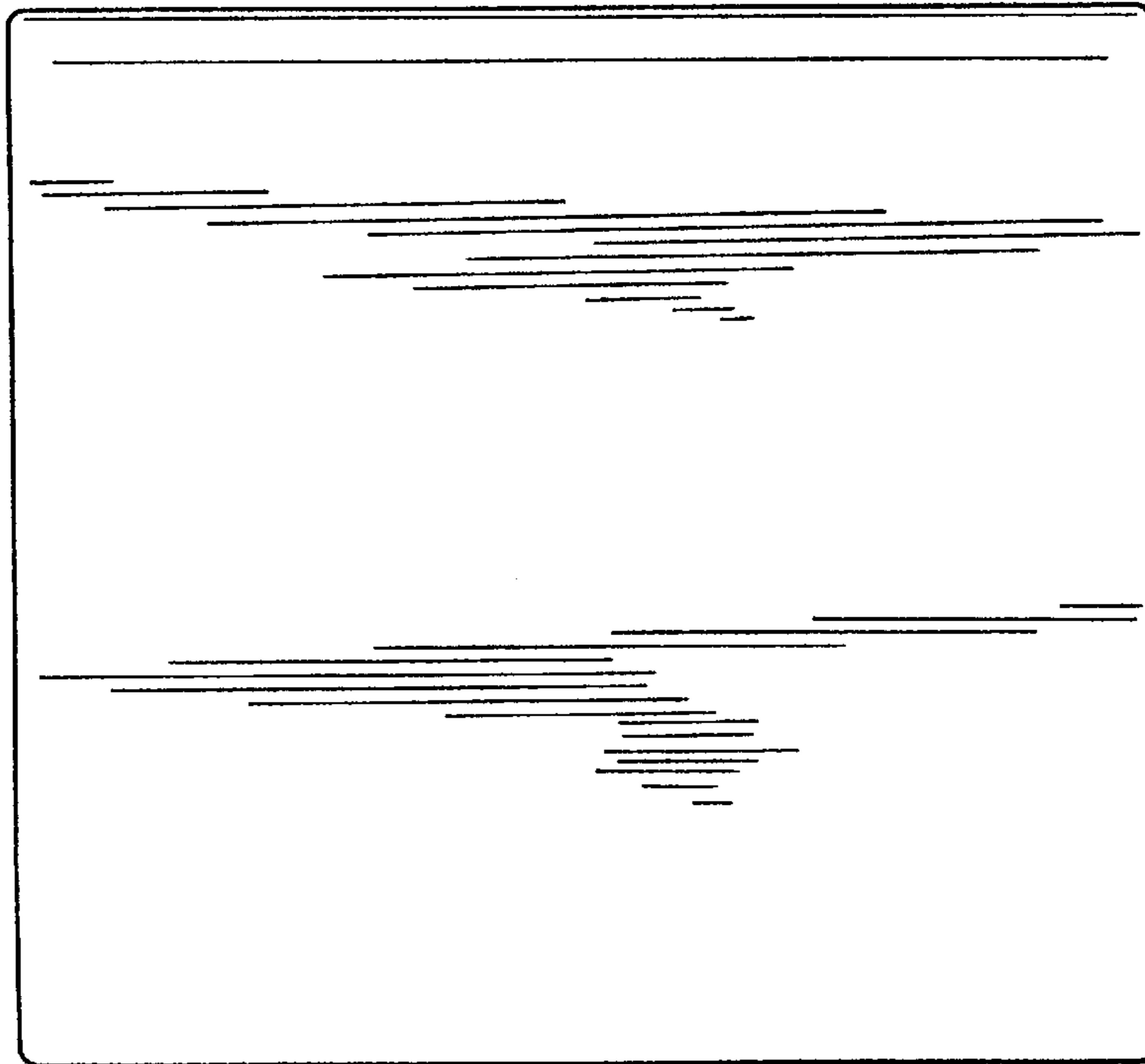

FIG. 21

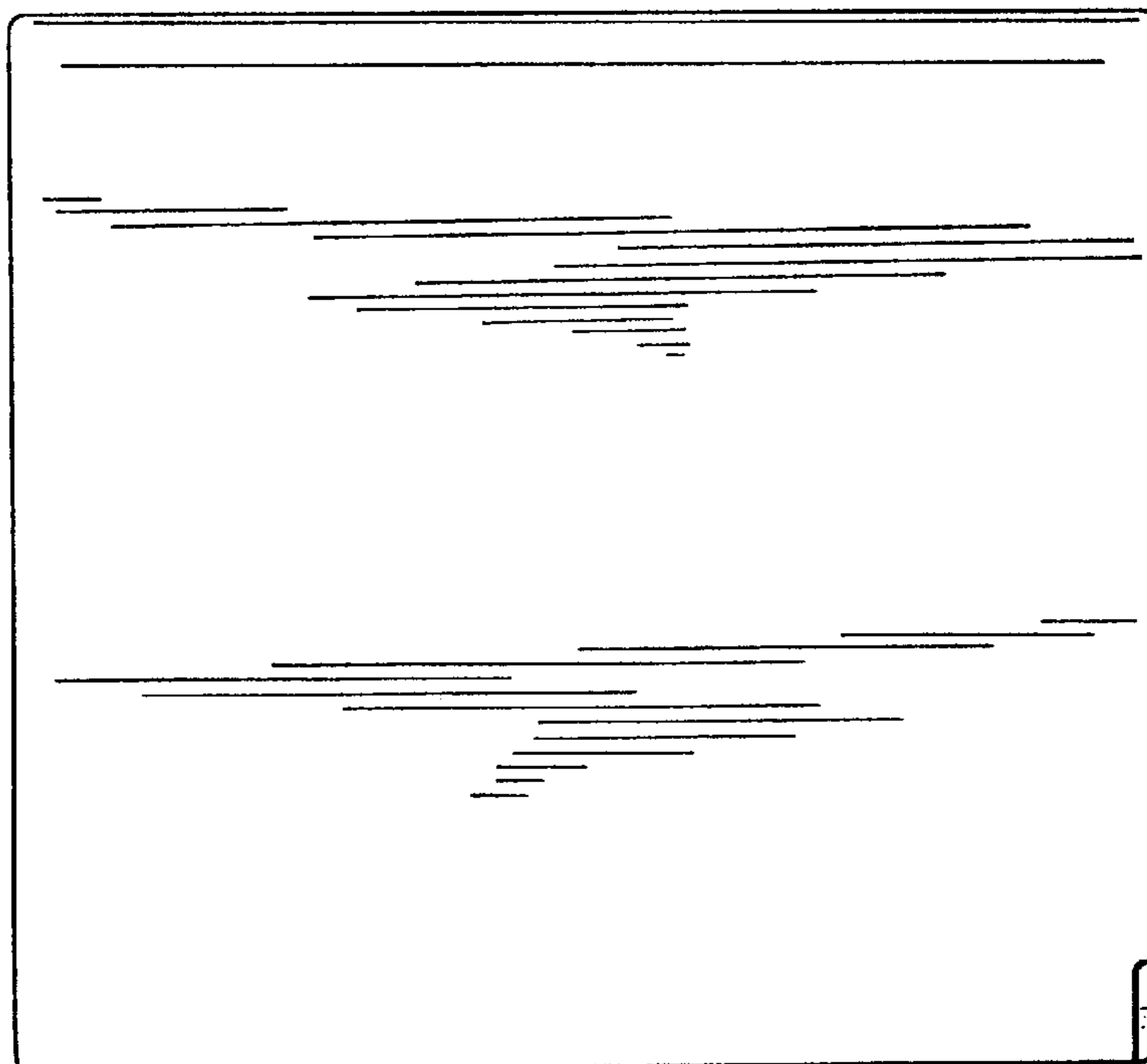

FIG. 22

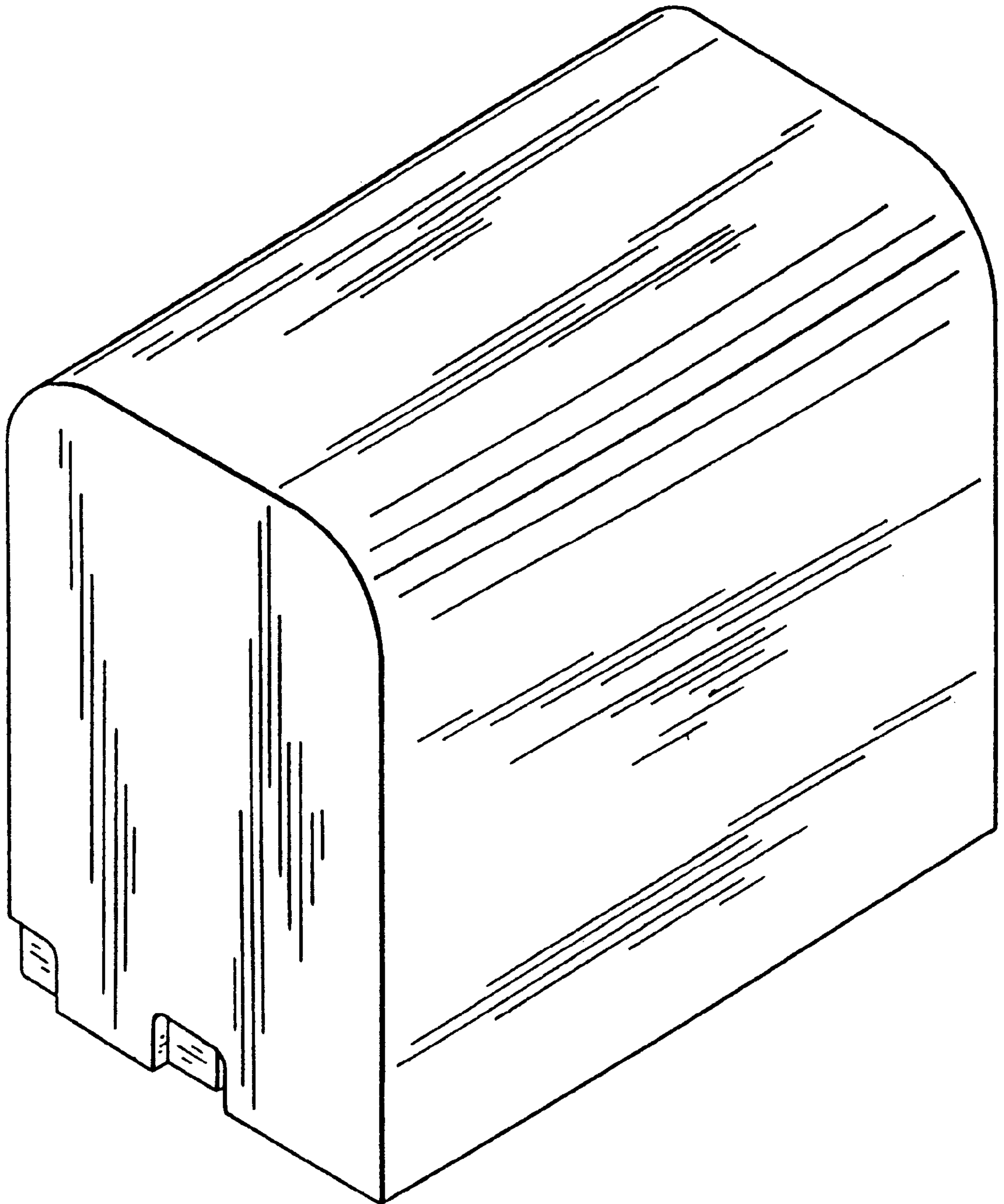

FIG. 23

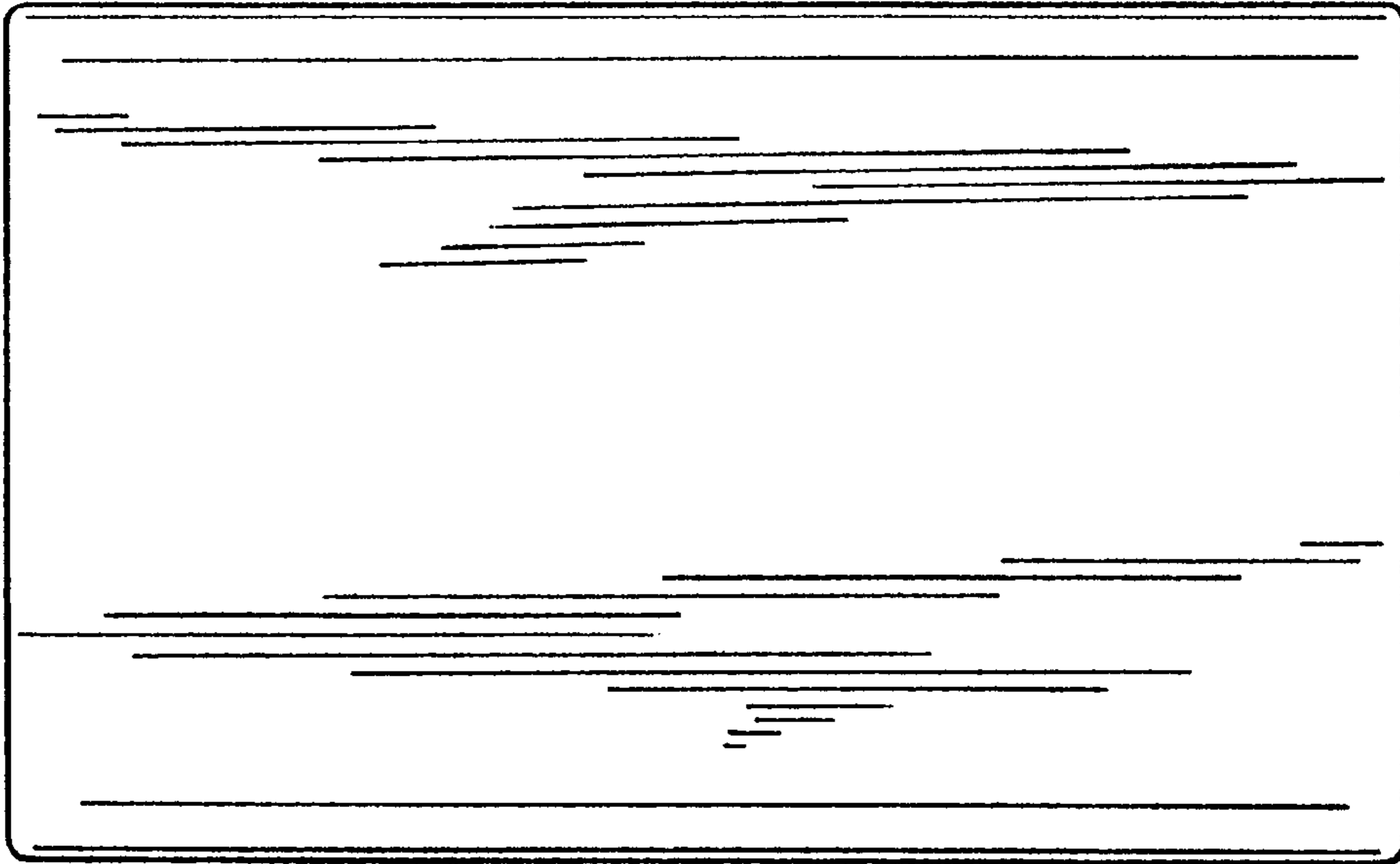

FIG. 26

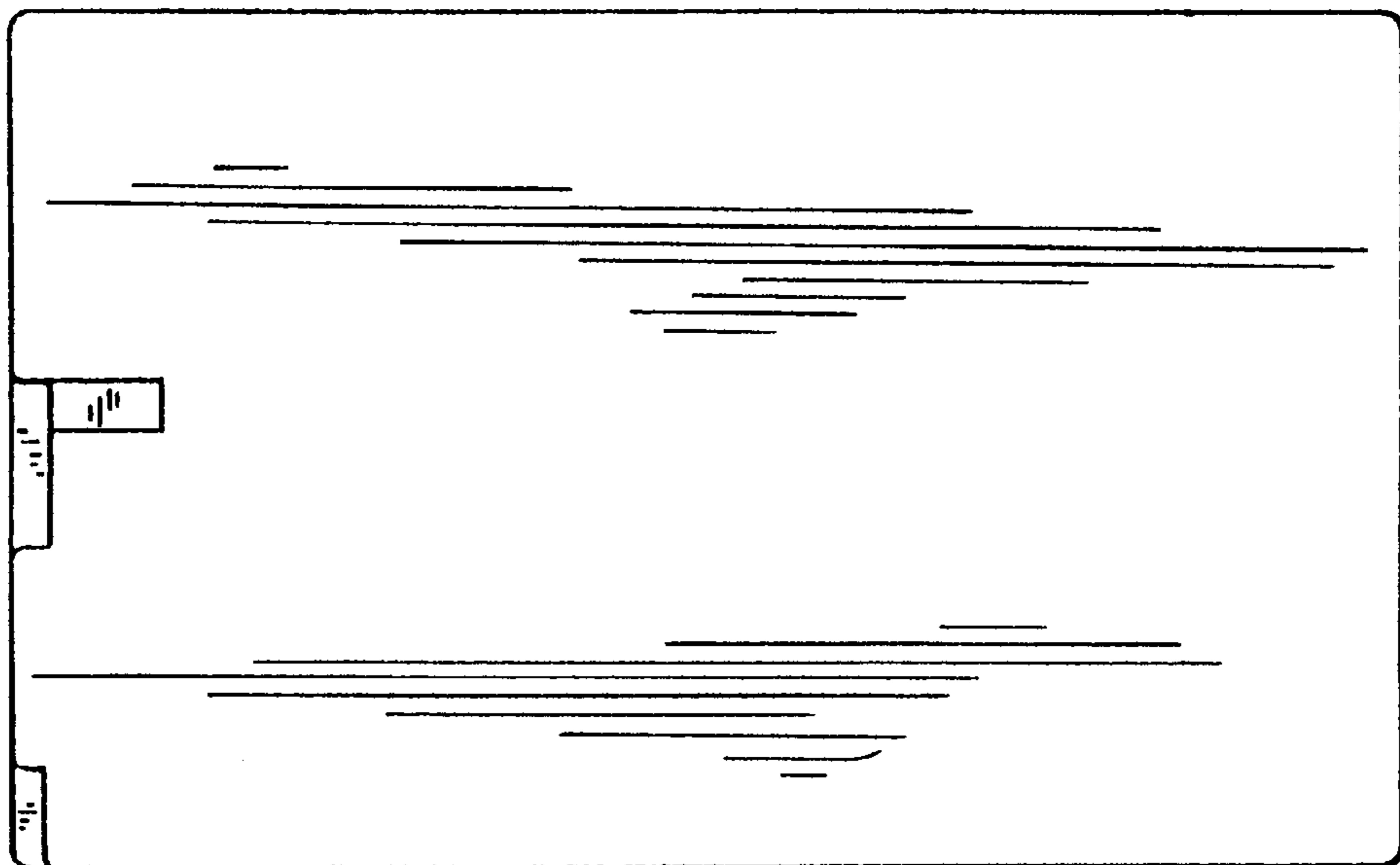

FIG. 24

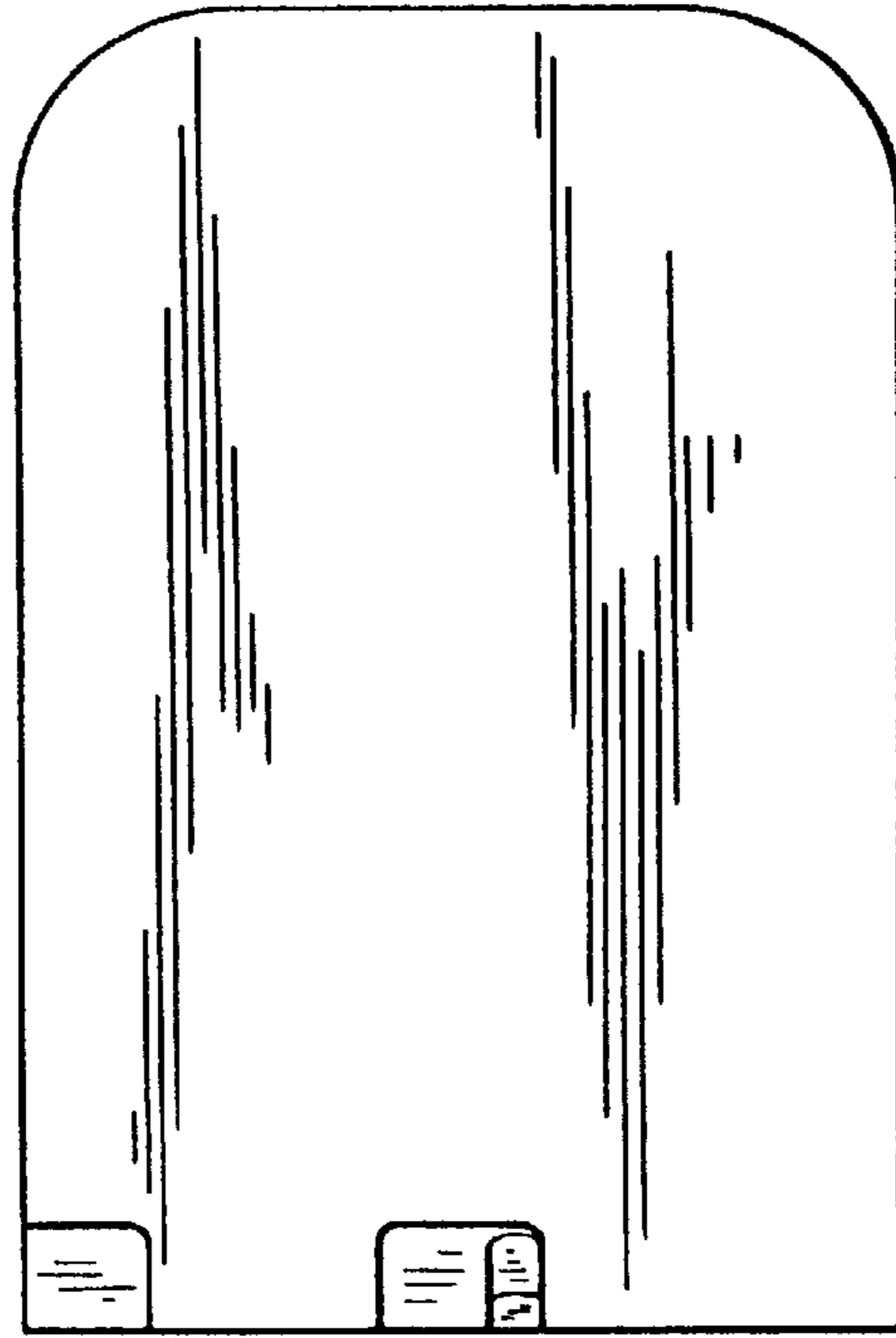

FIG. 27

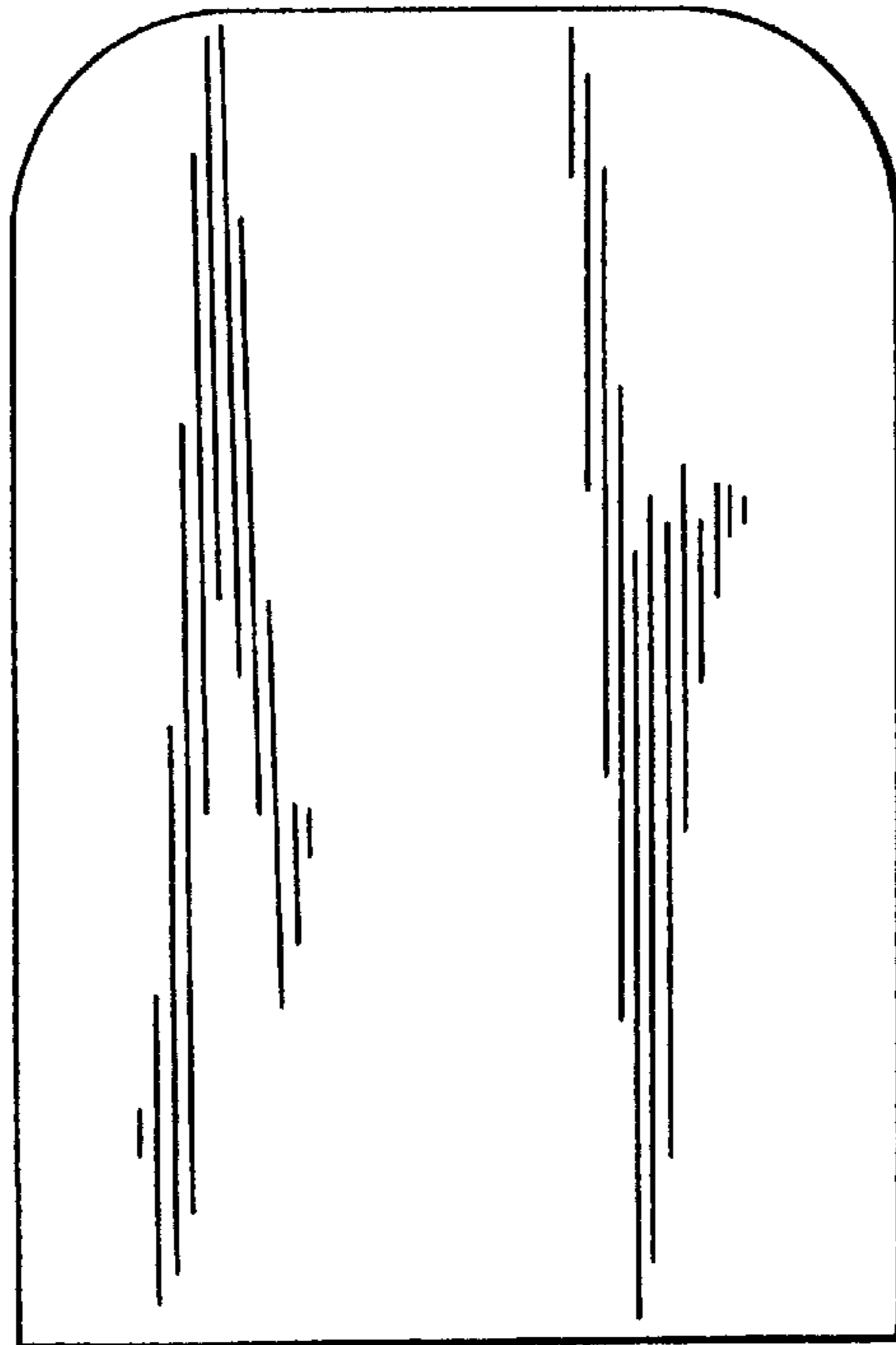

FIG. 25

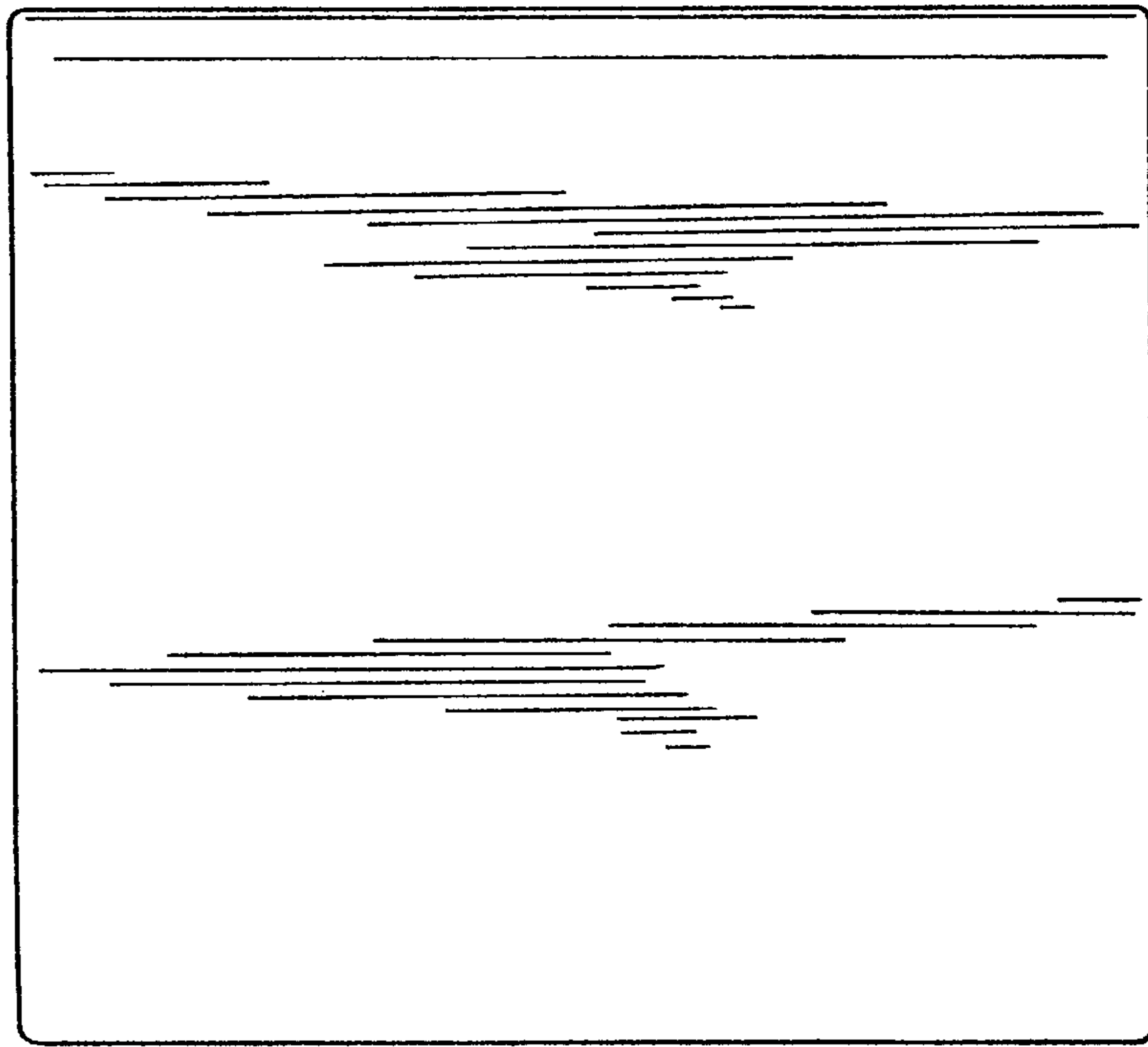

FIG. 28

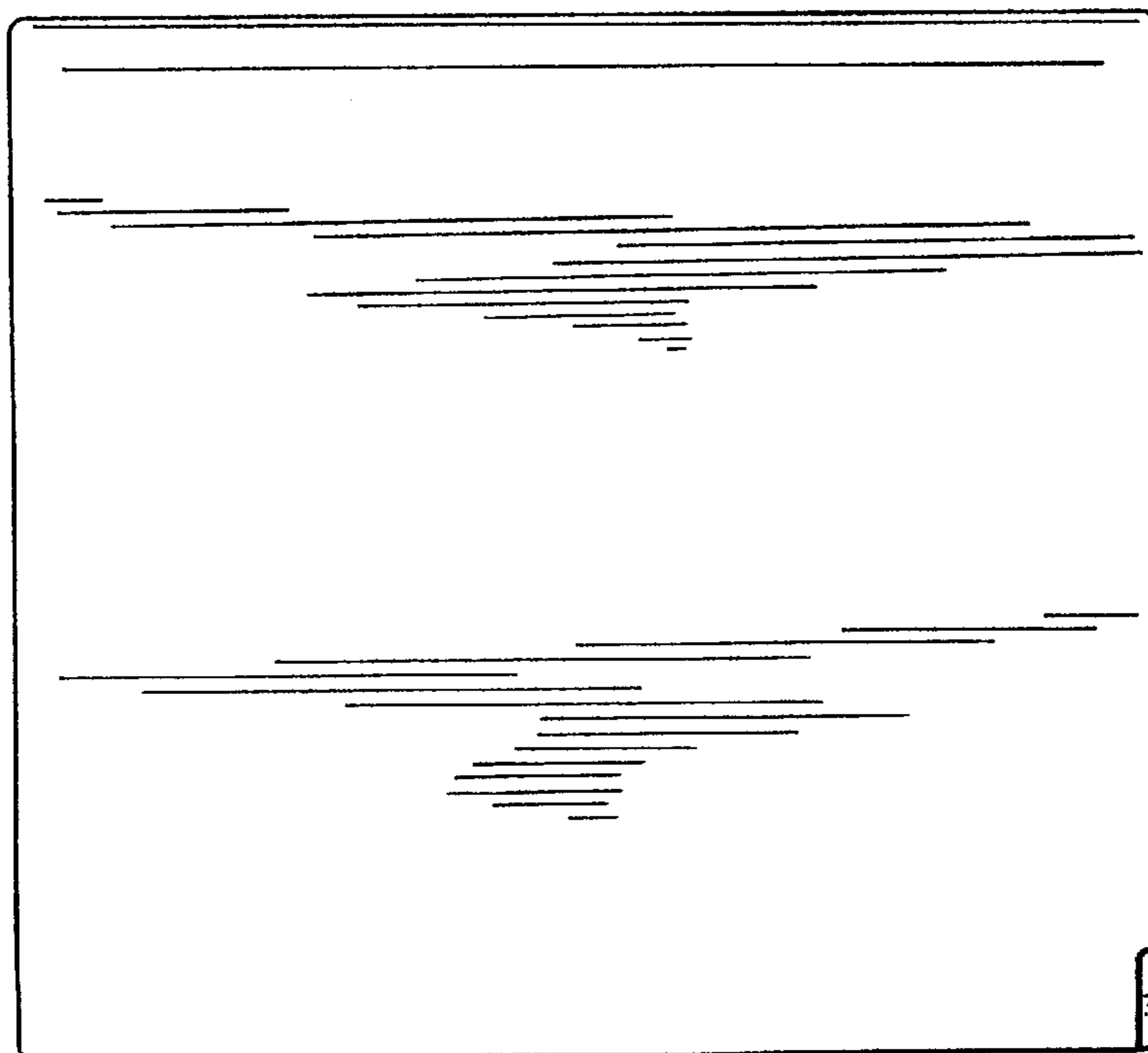

FIG. 29

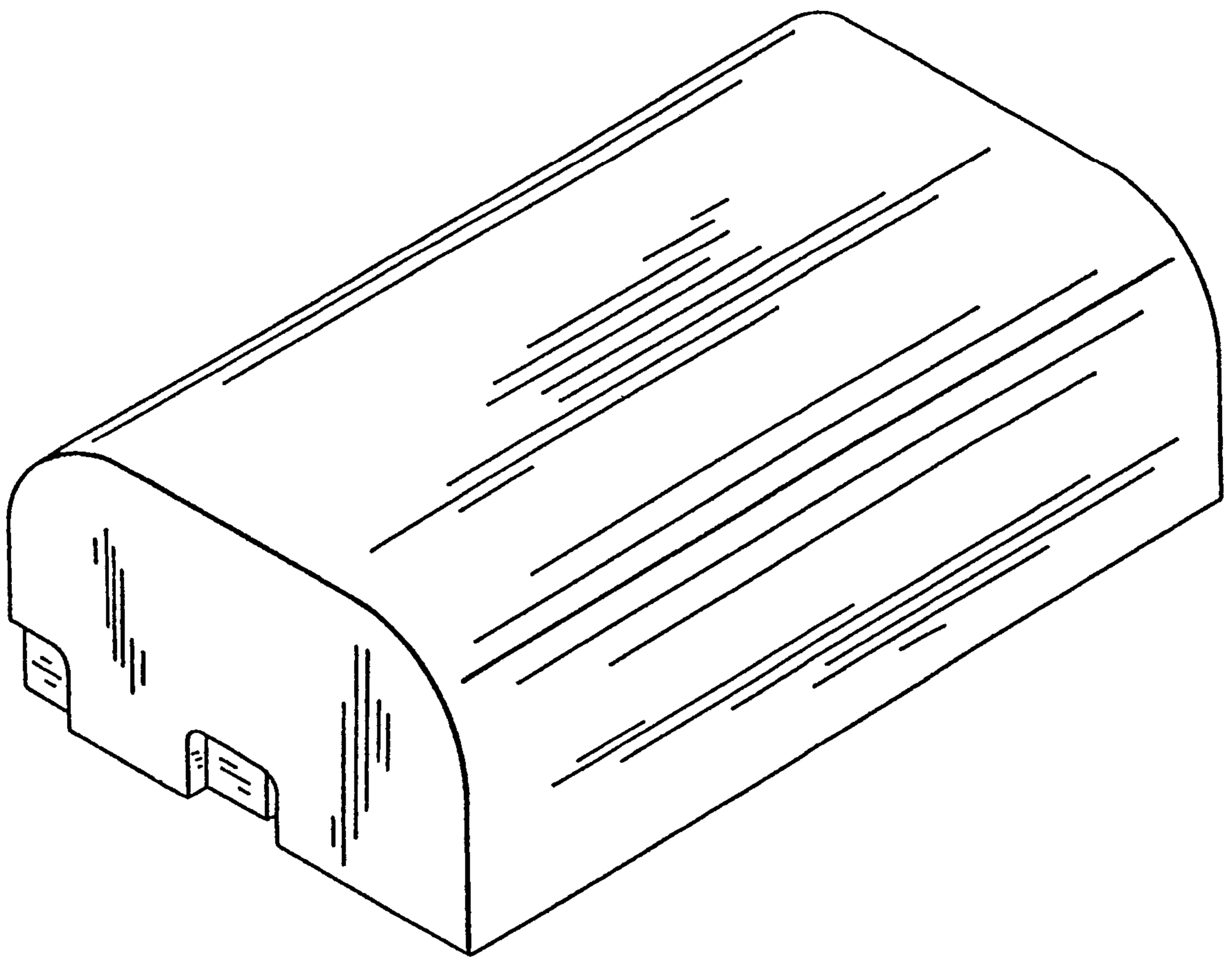

FIG. 30

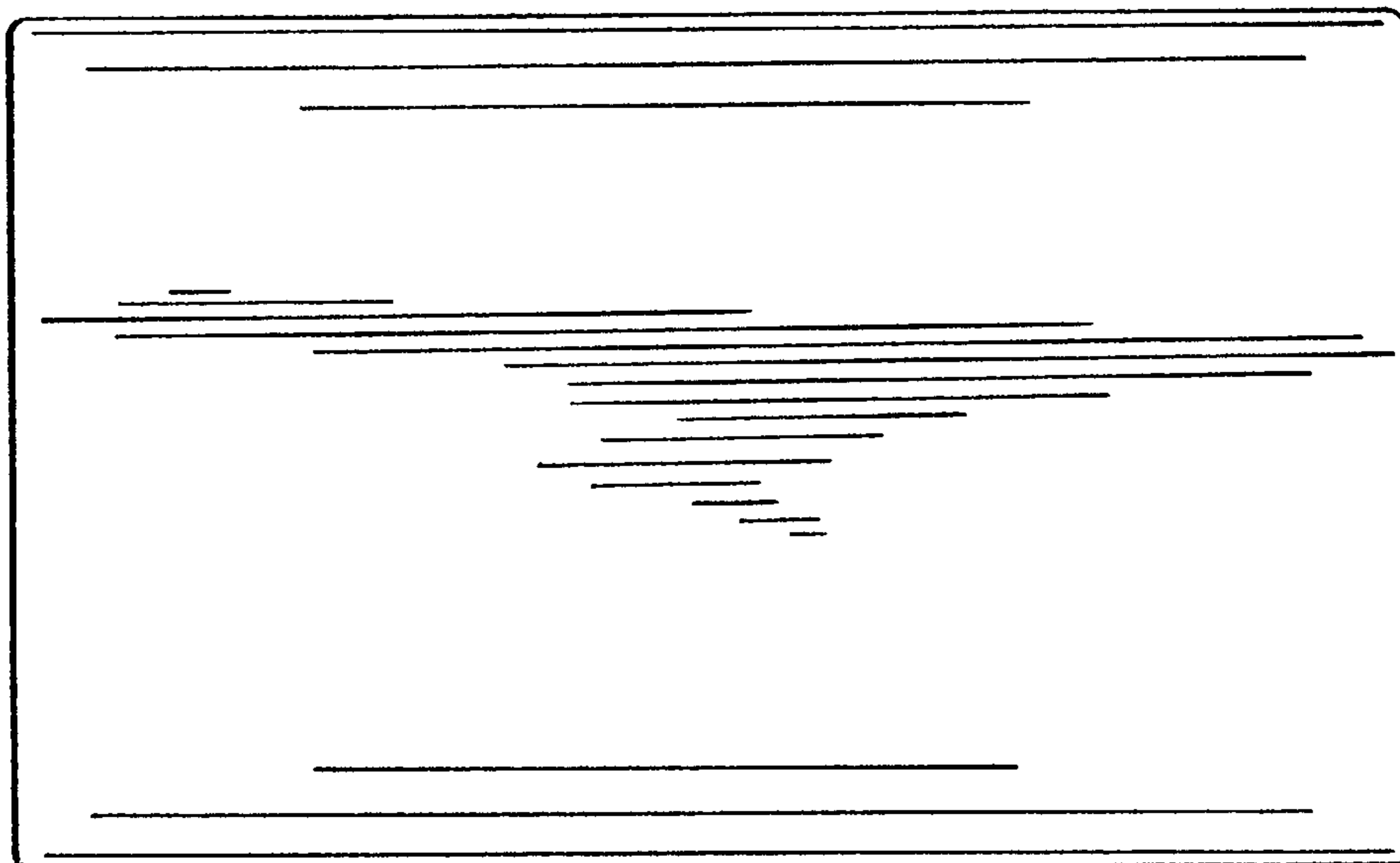

FIG. 33

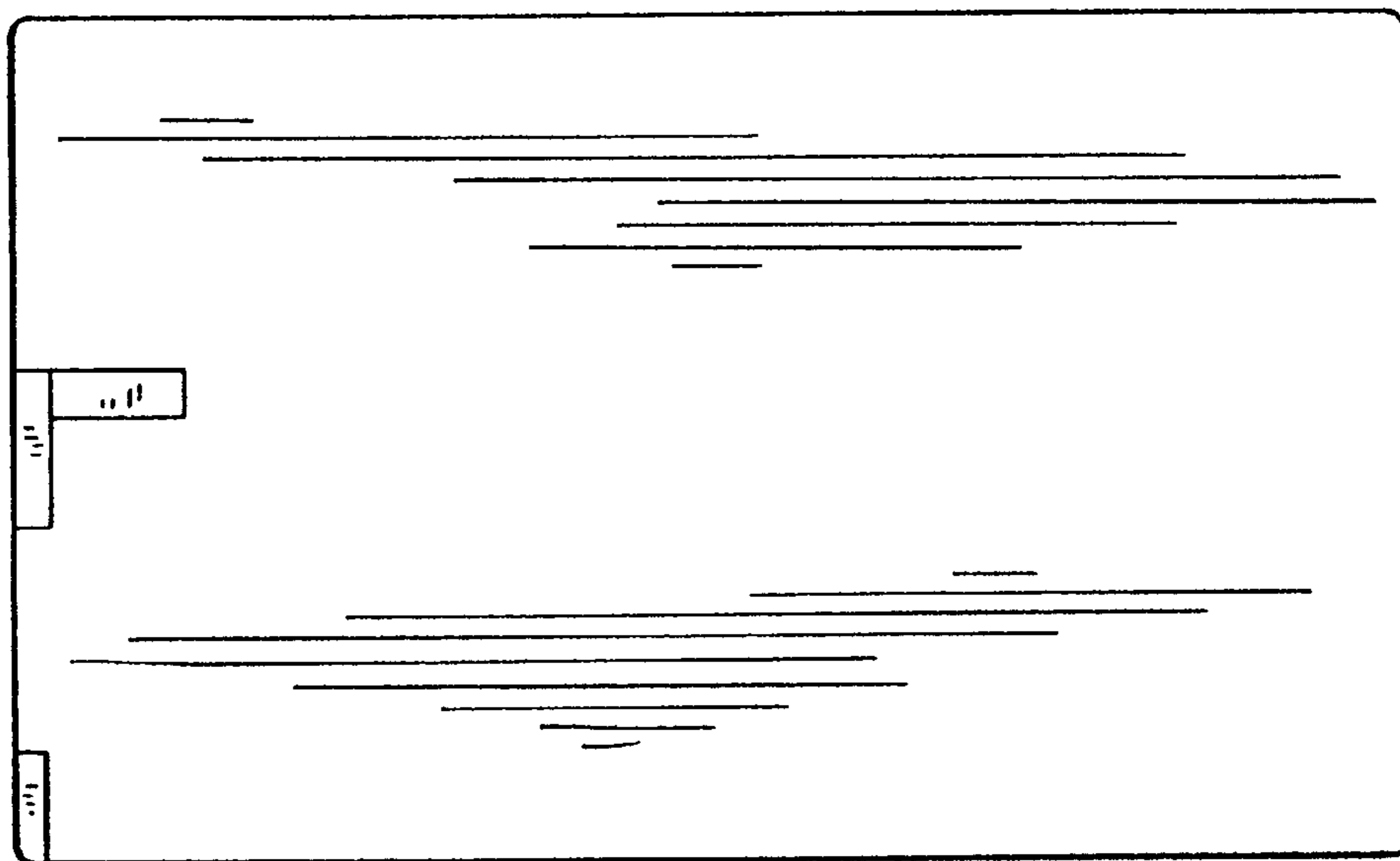

FIG. 31

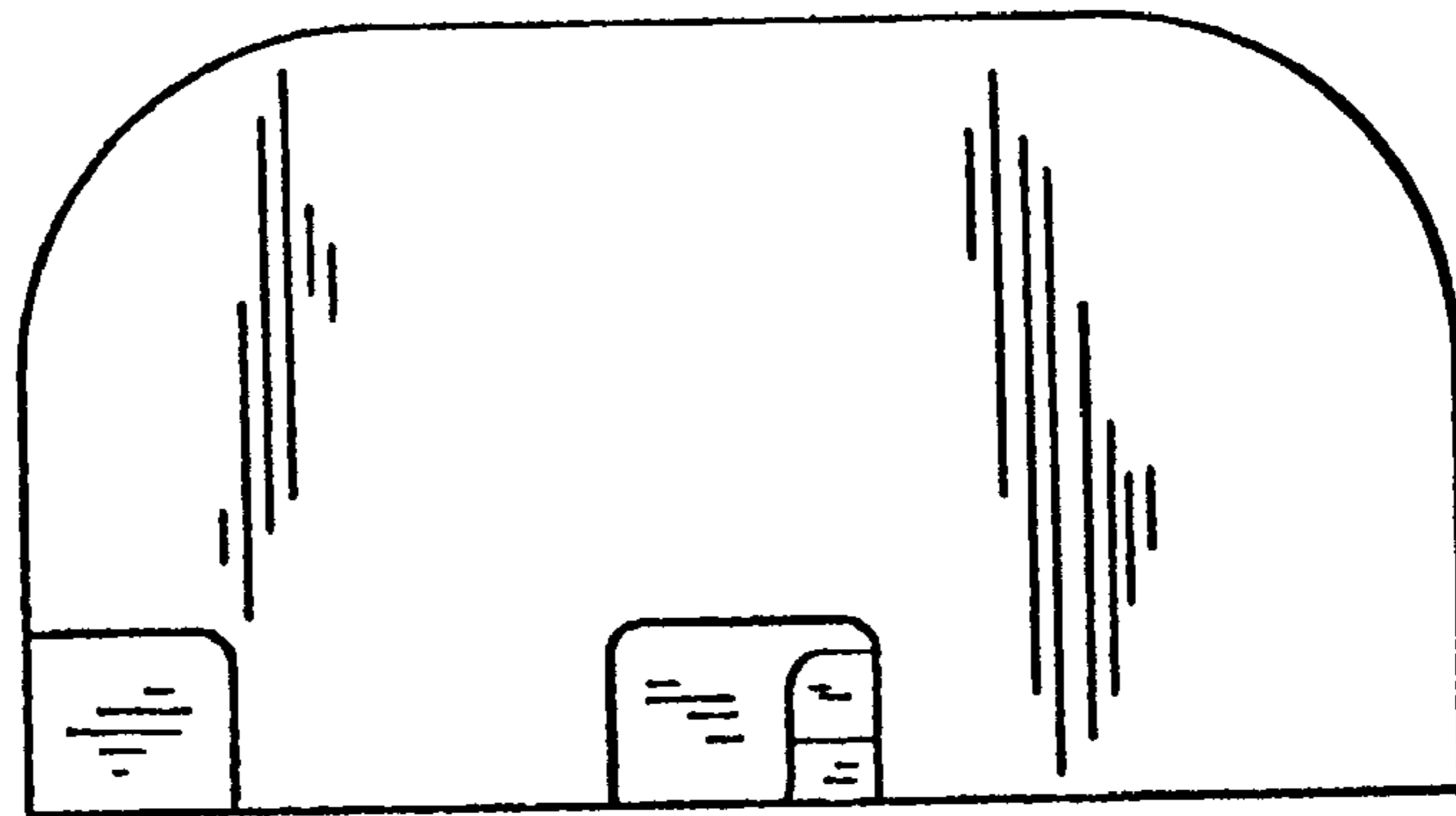

FIG. 34

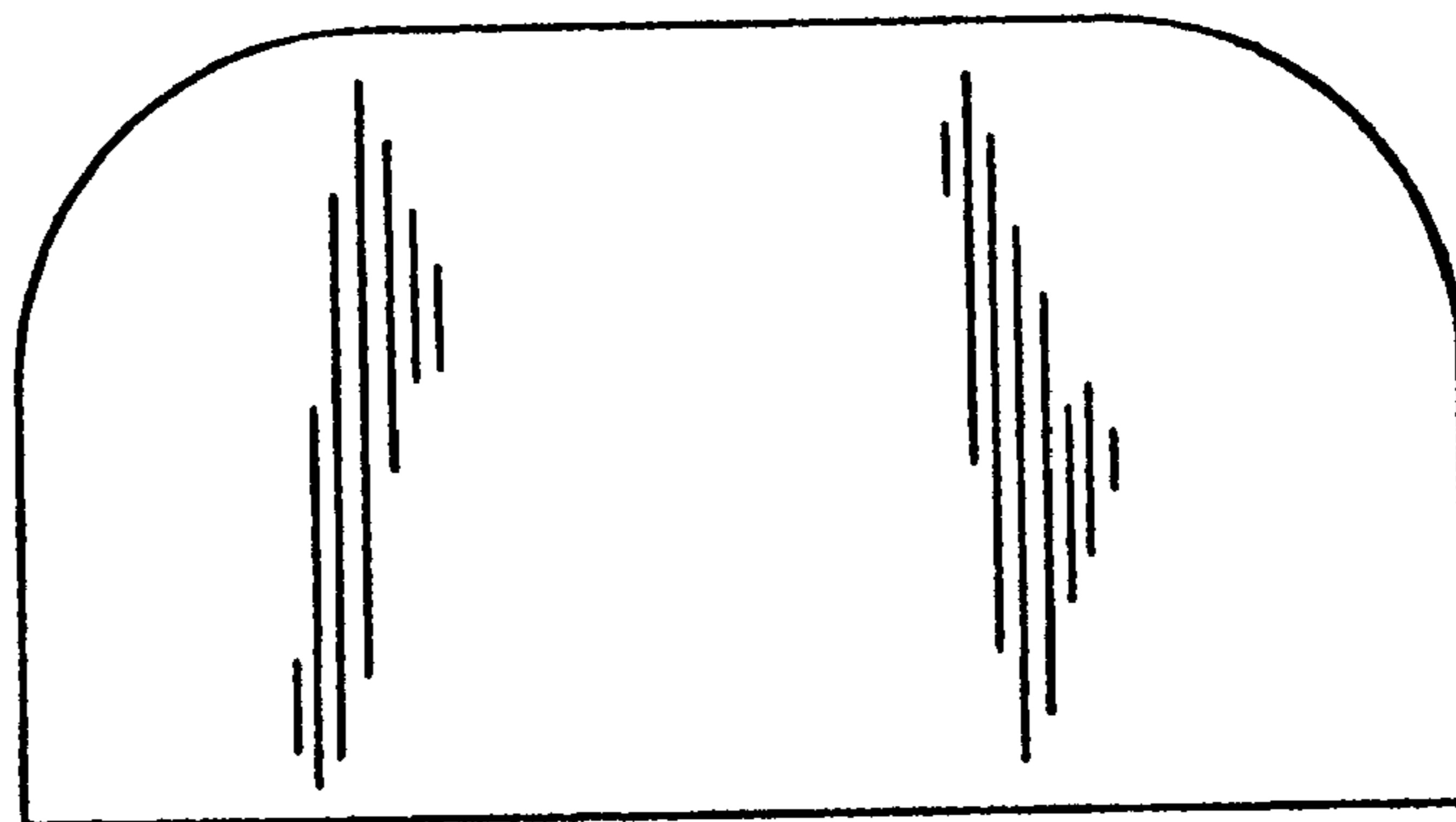

FIG. 32

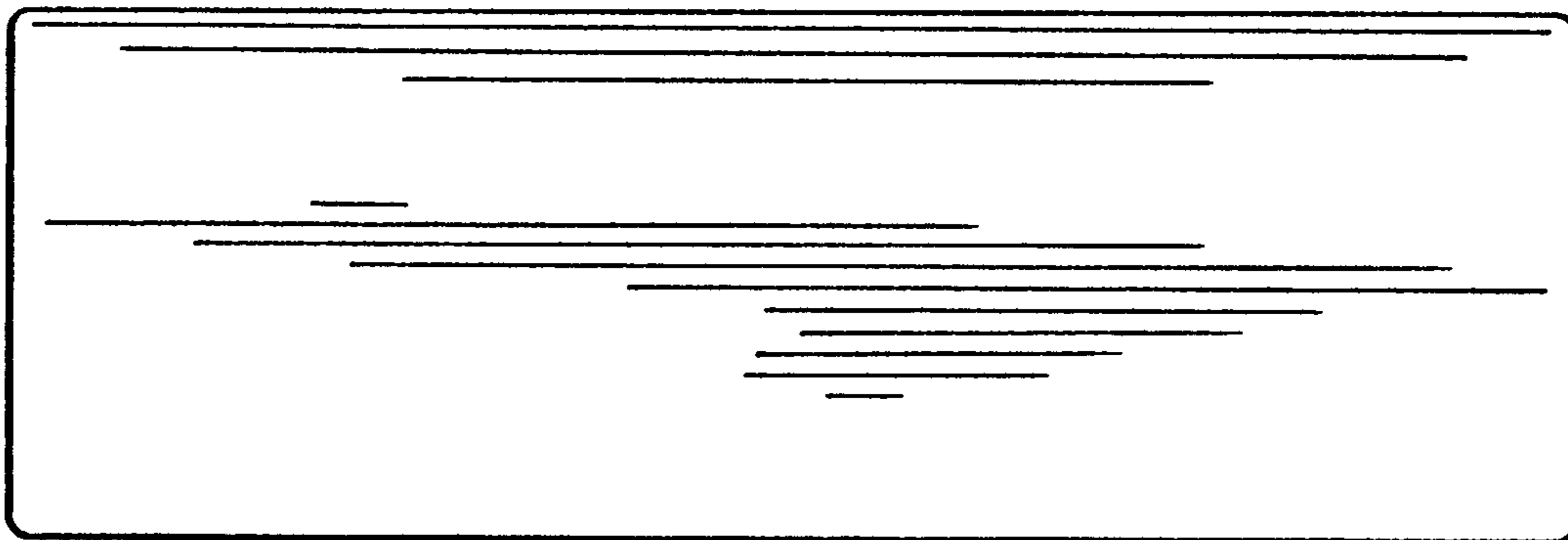

FIG. 35

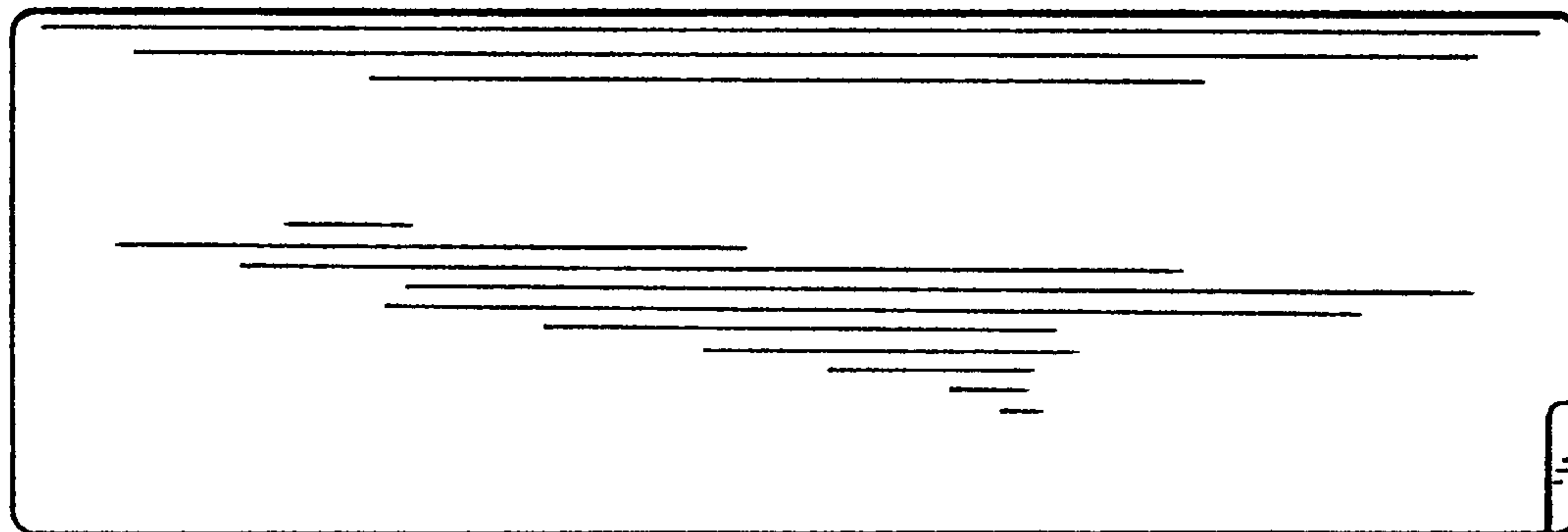

FIG. 36

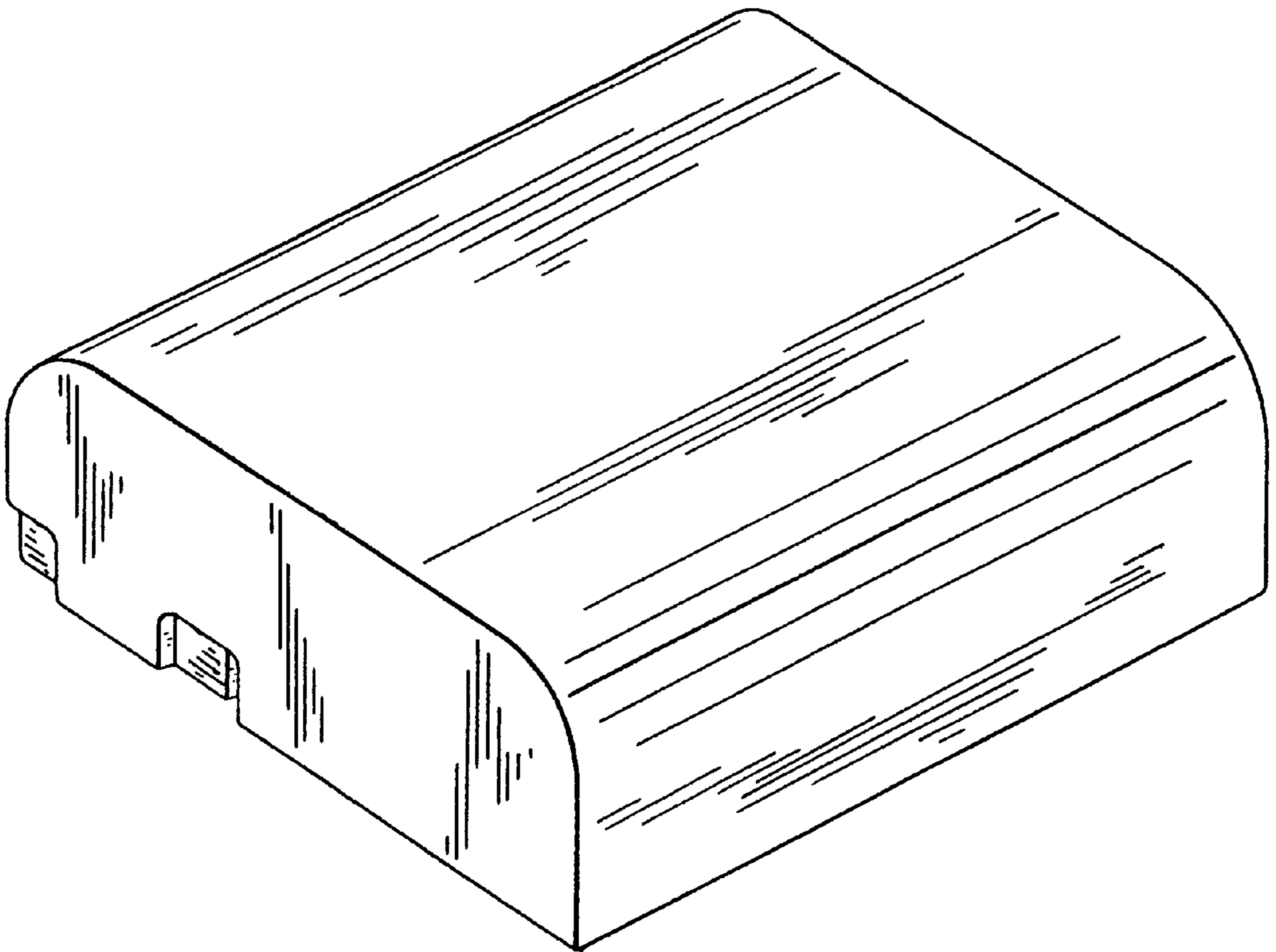

FIG. 37

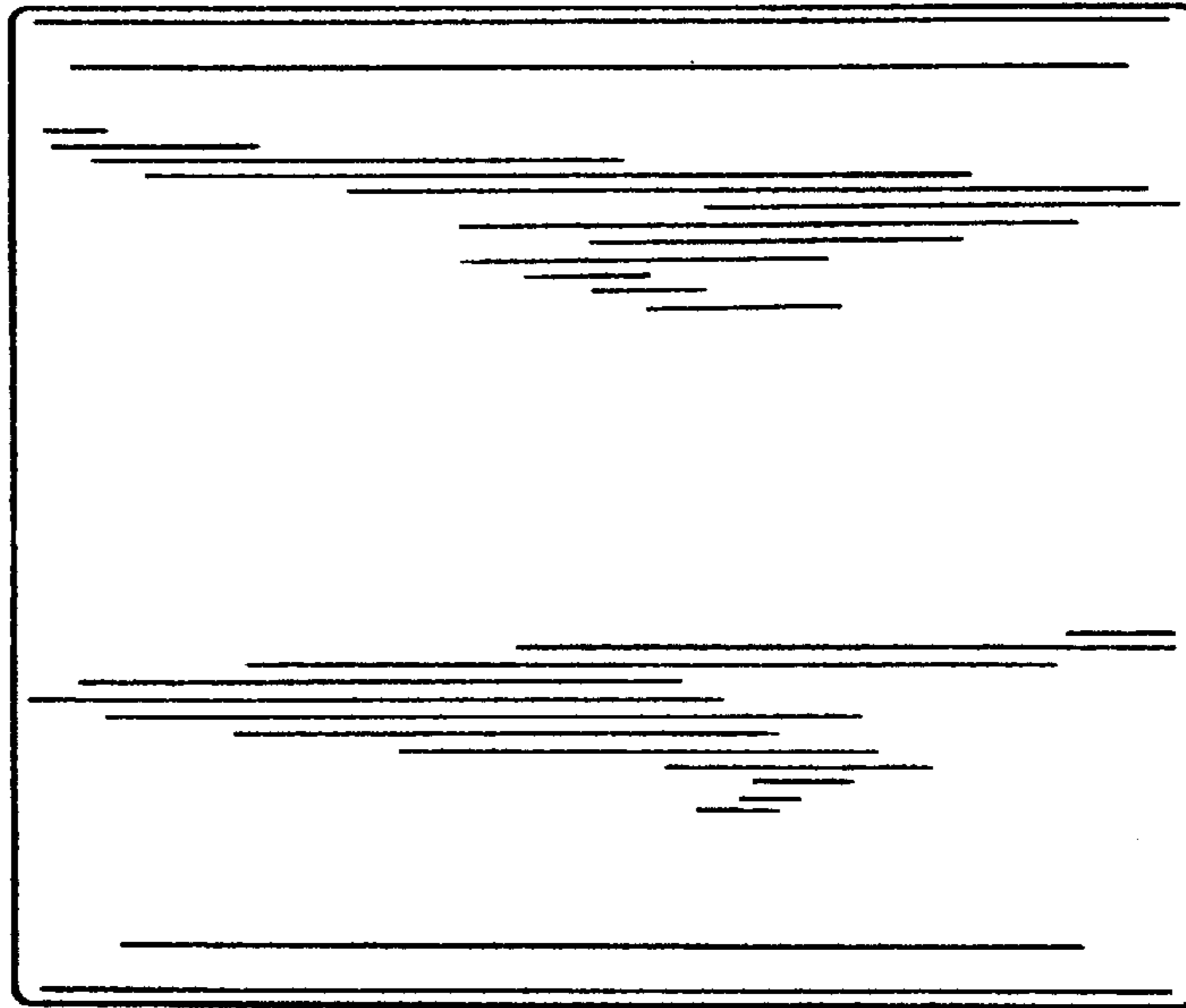

FIG. 40

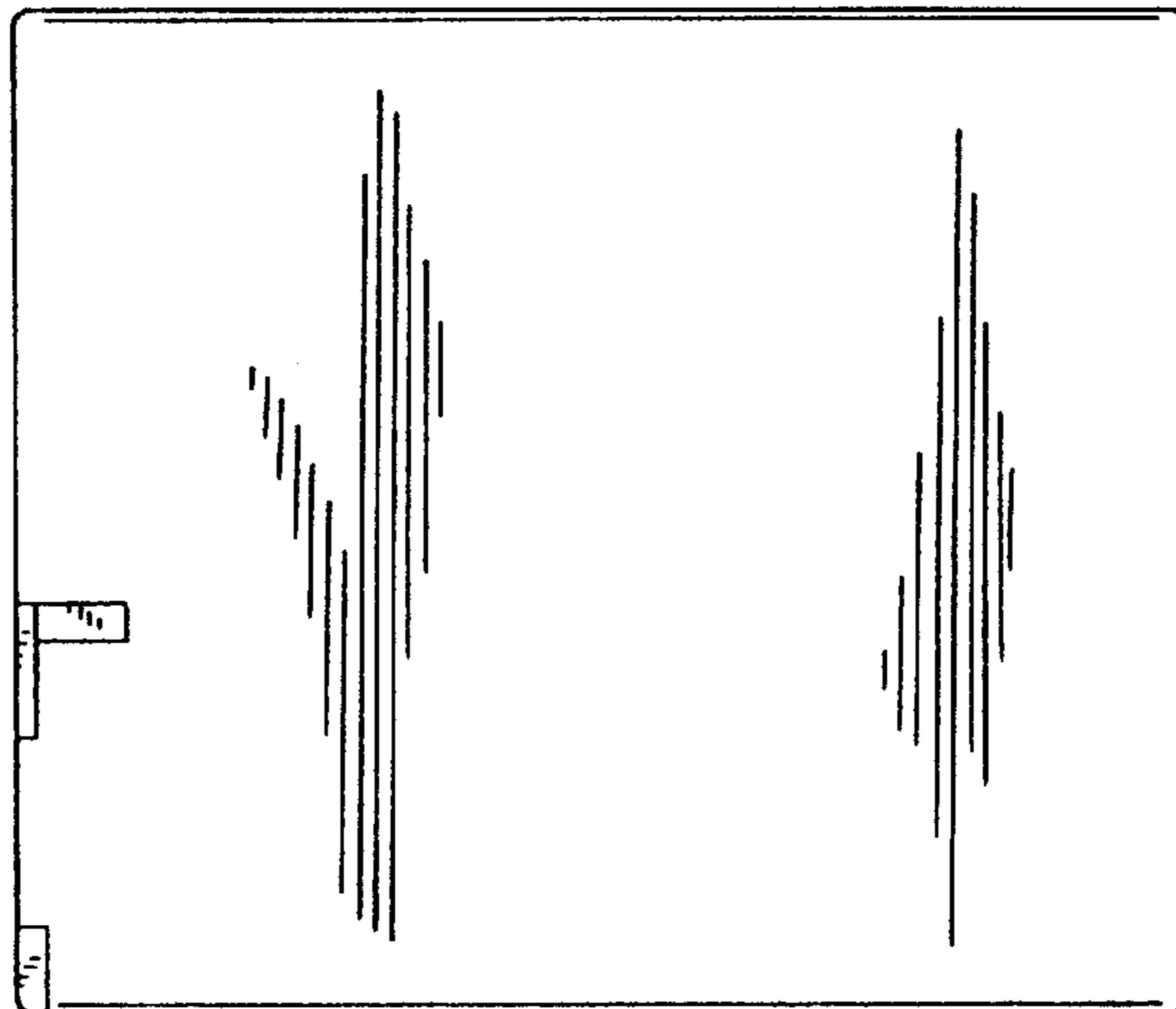

FIG. 38

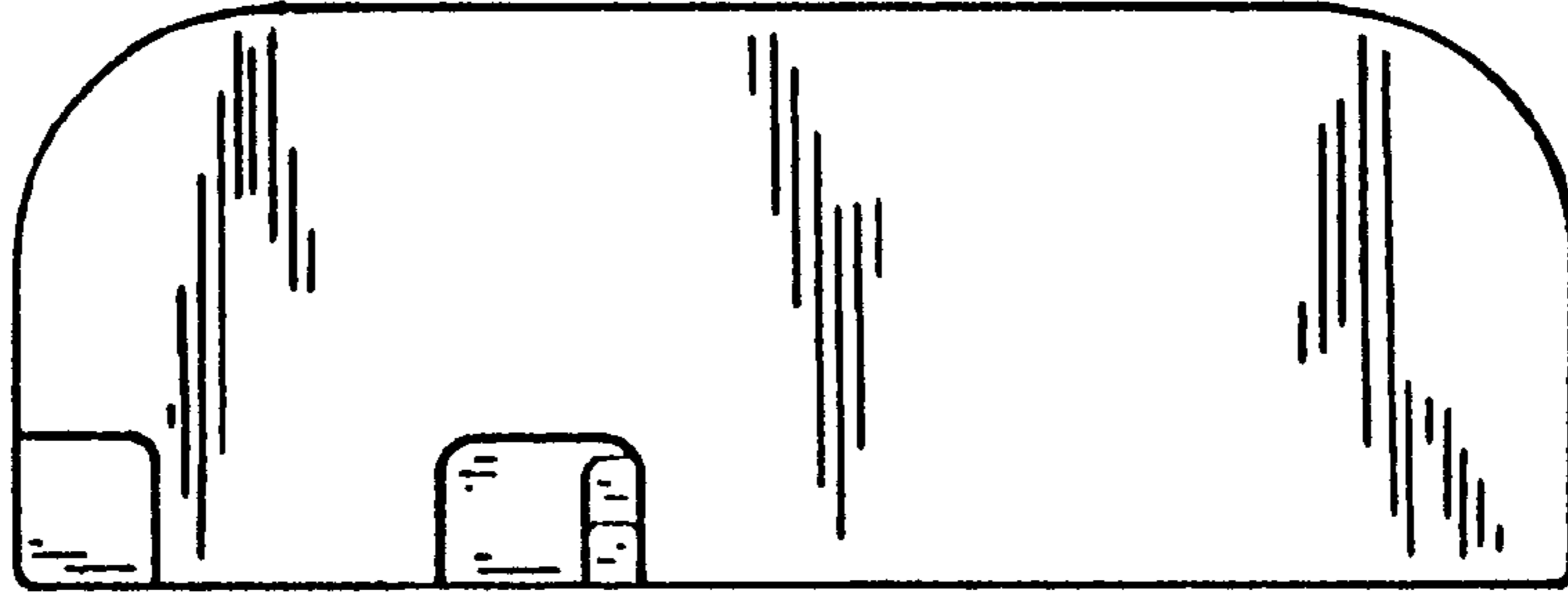

FIG. 41

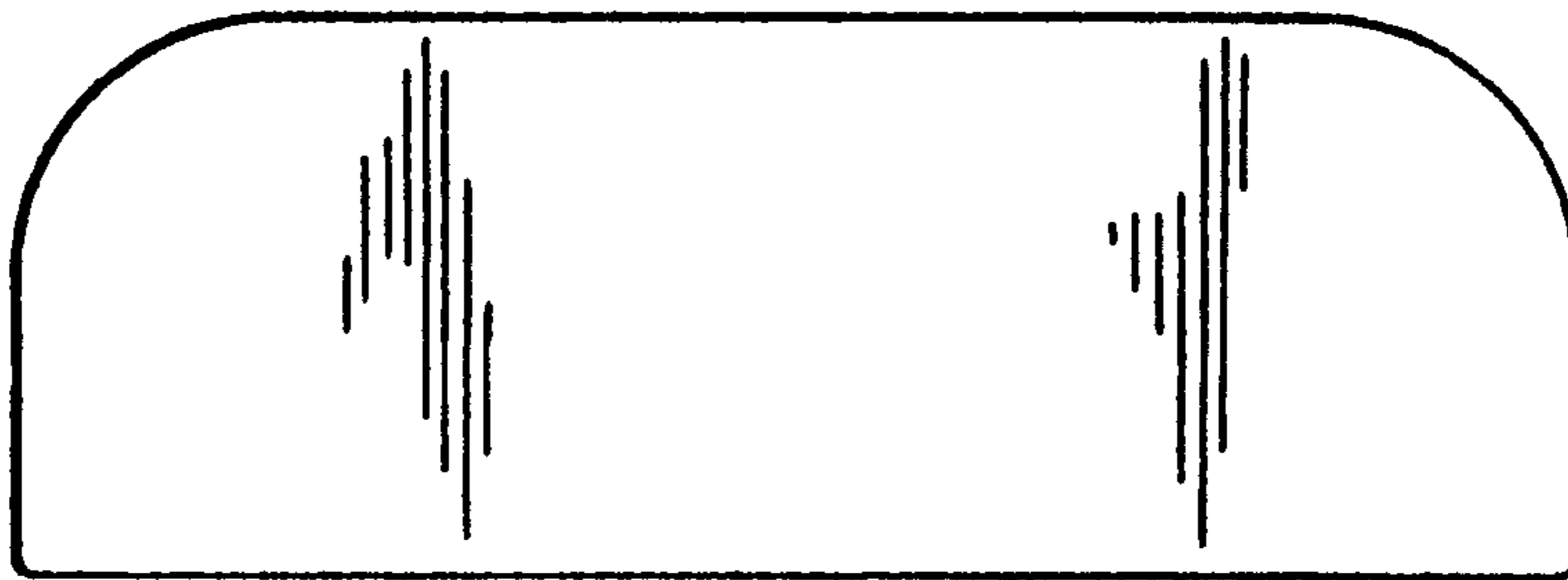

FIG. 39

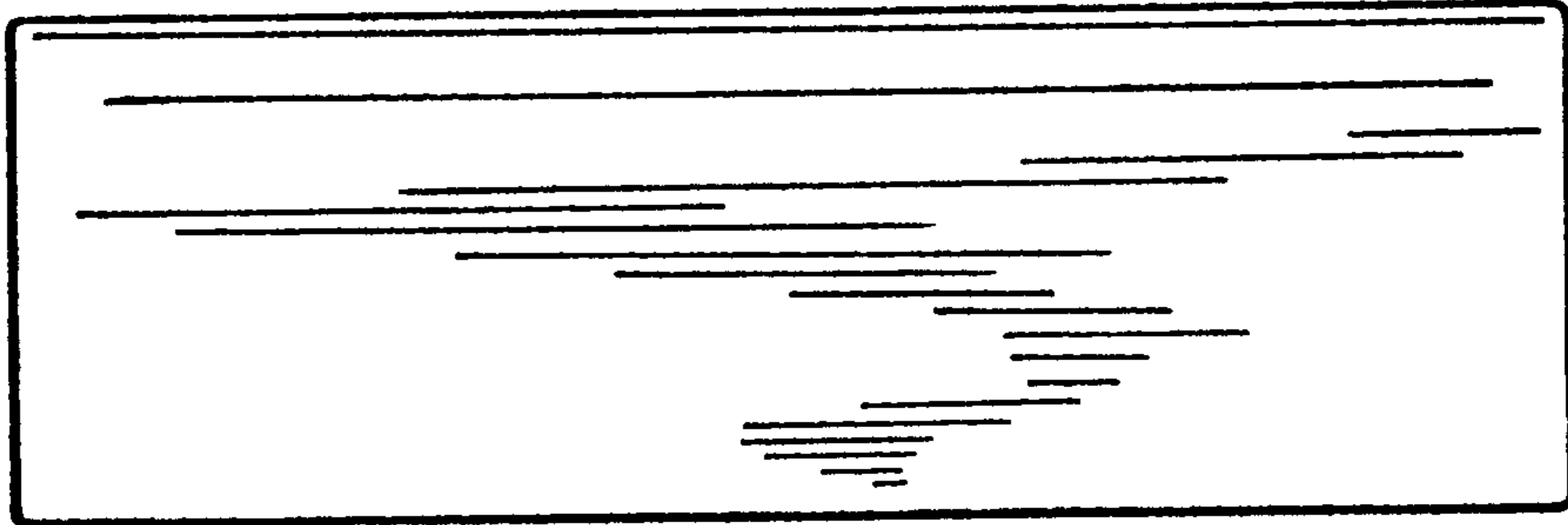

FIG. 42

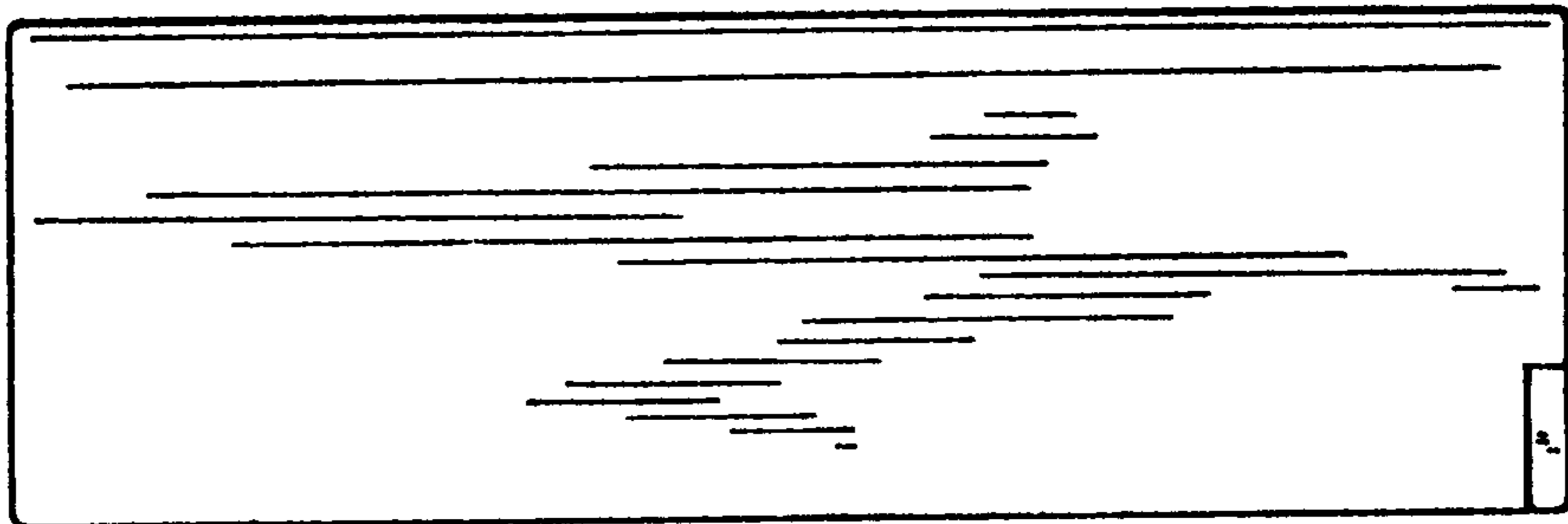

FIG. 43

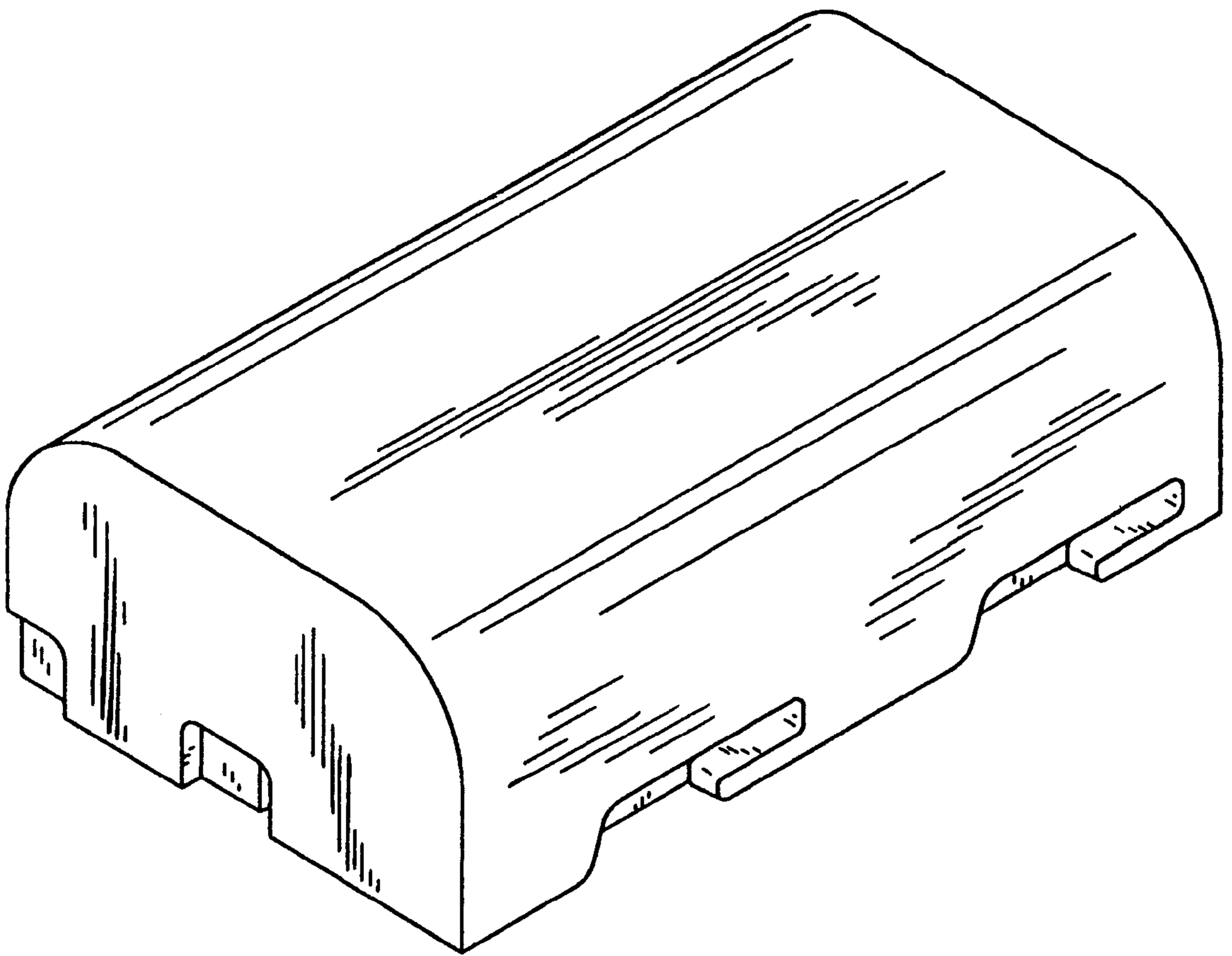

FIG. 44

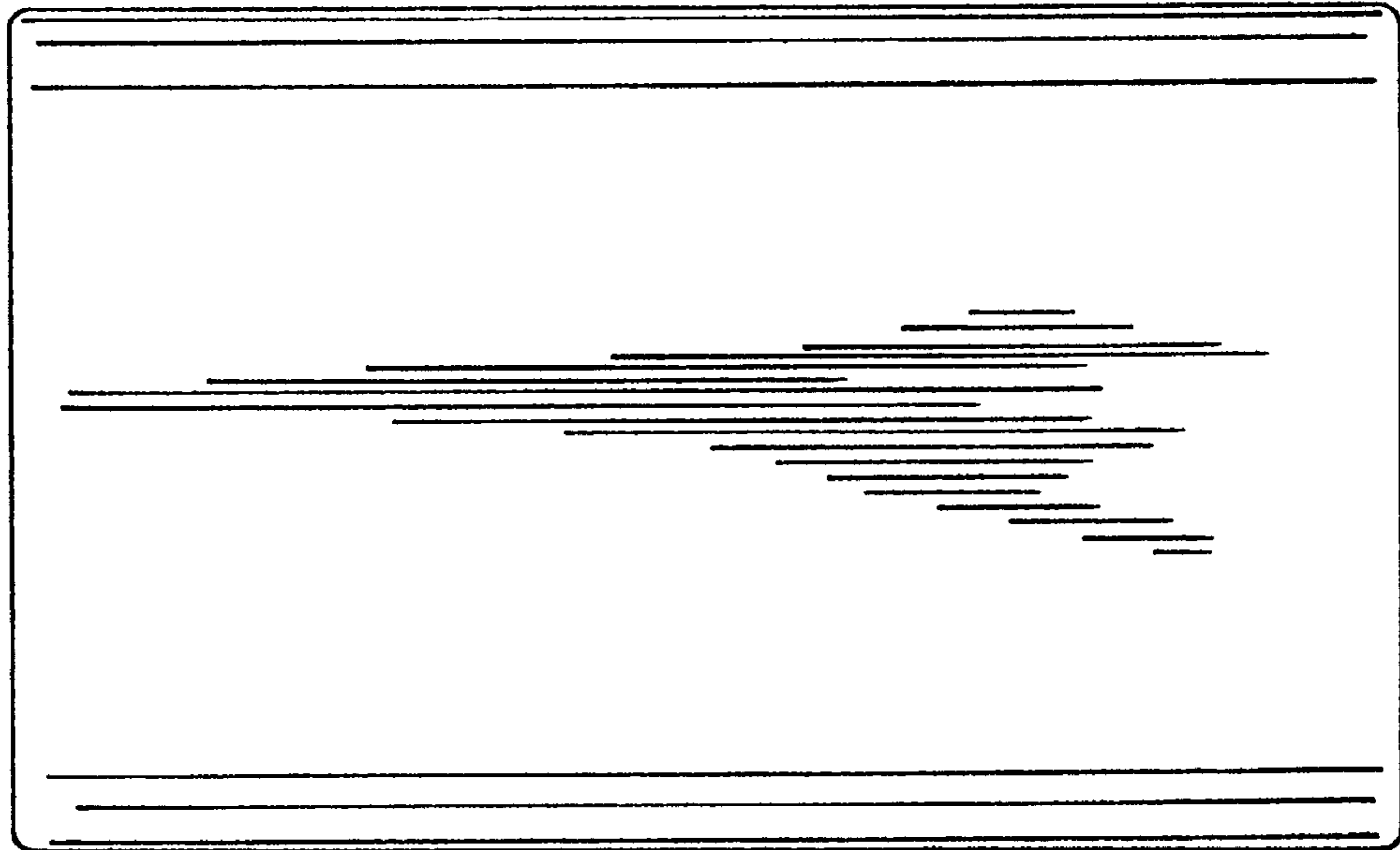

FIG. 47

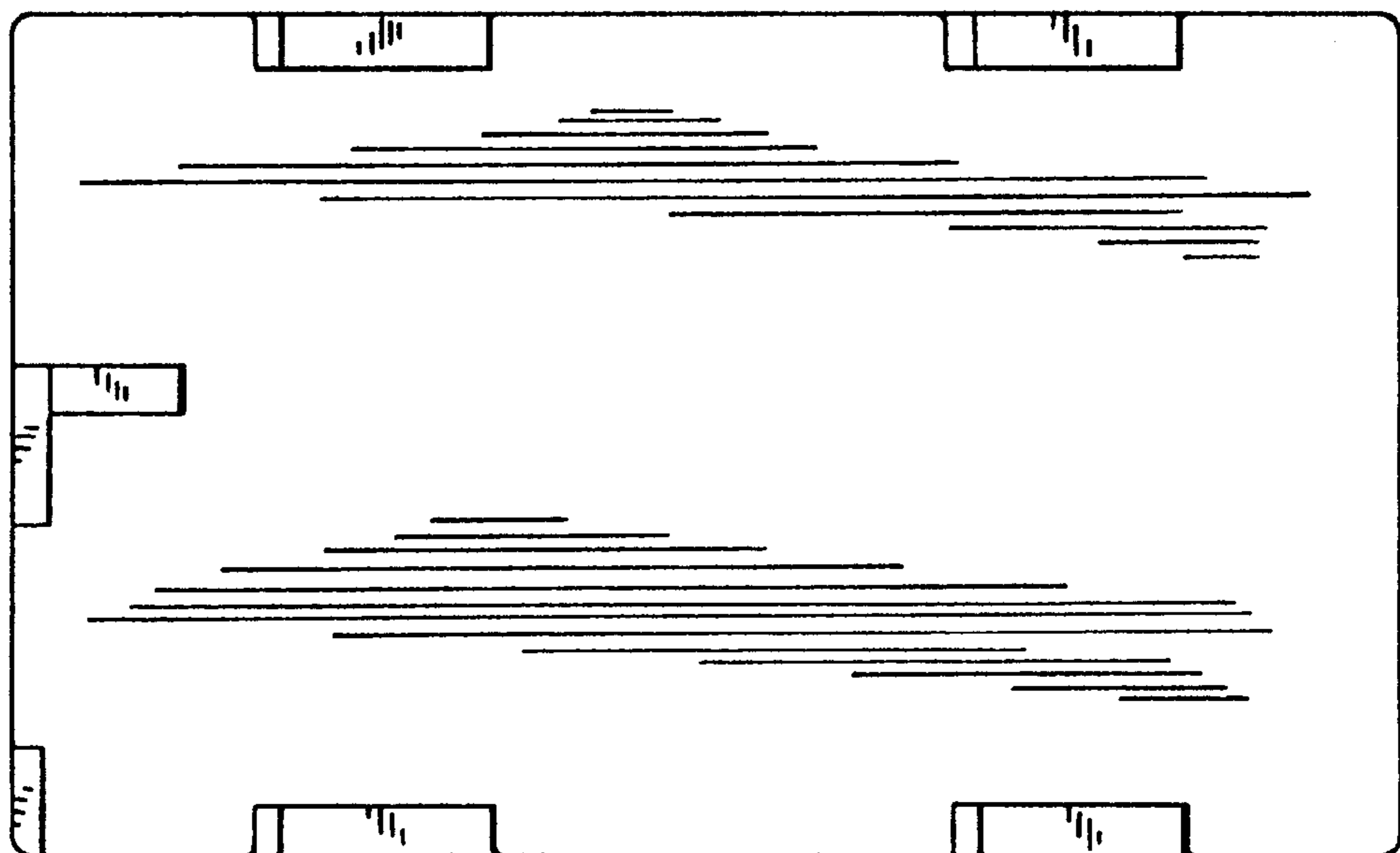

FIG. 45

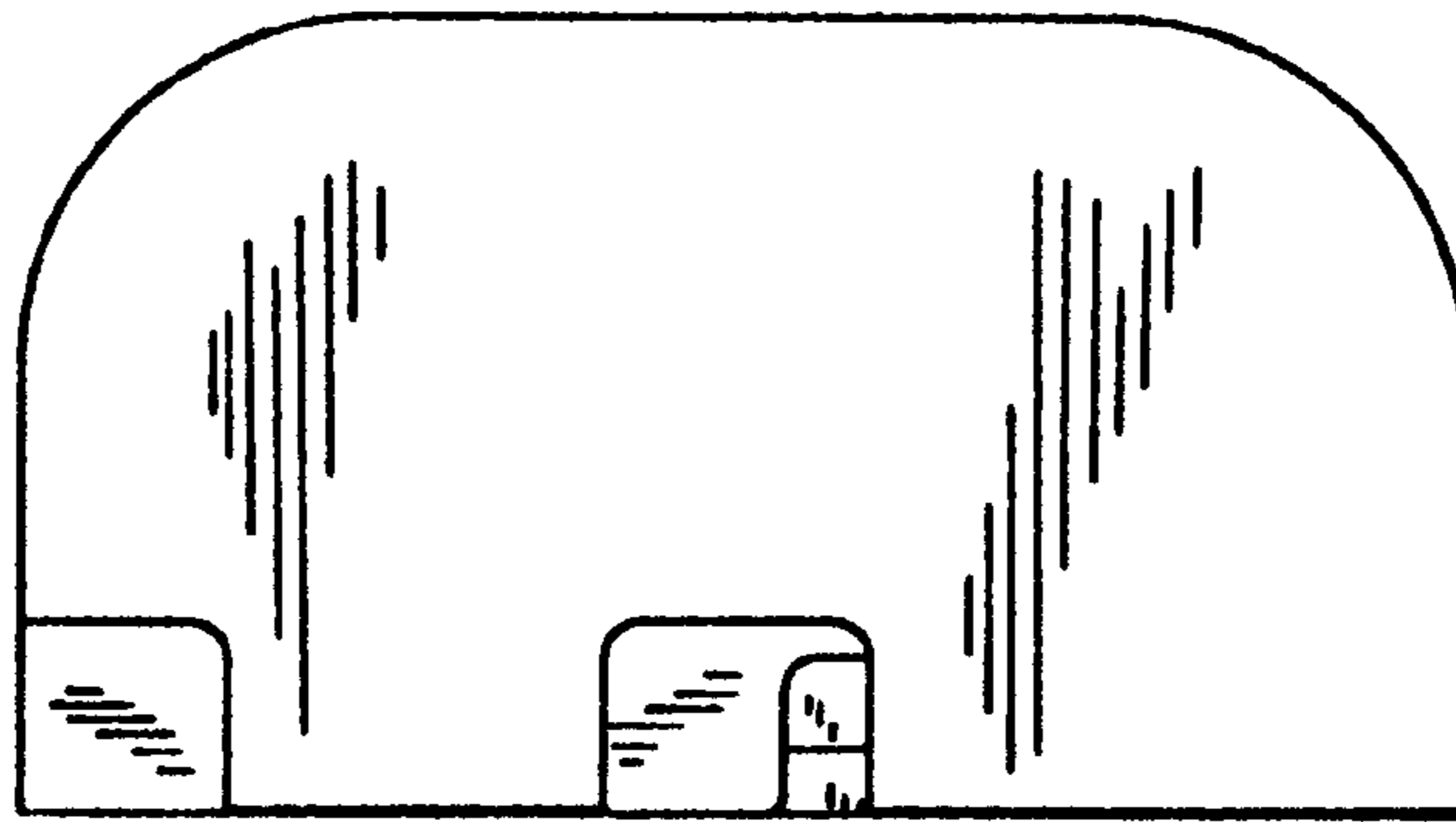

FIG. 48

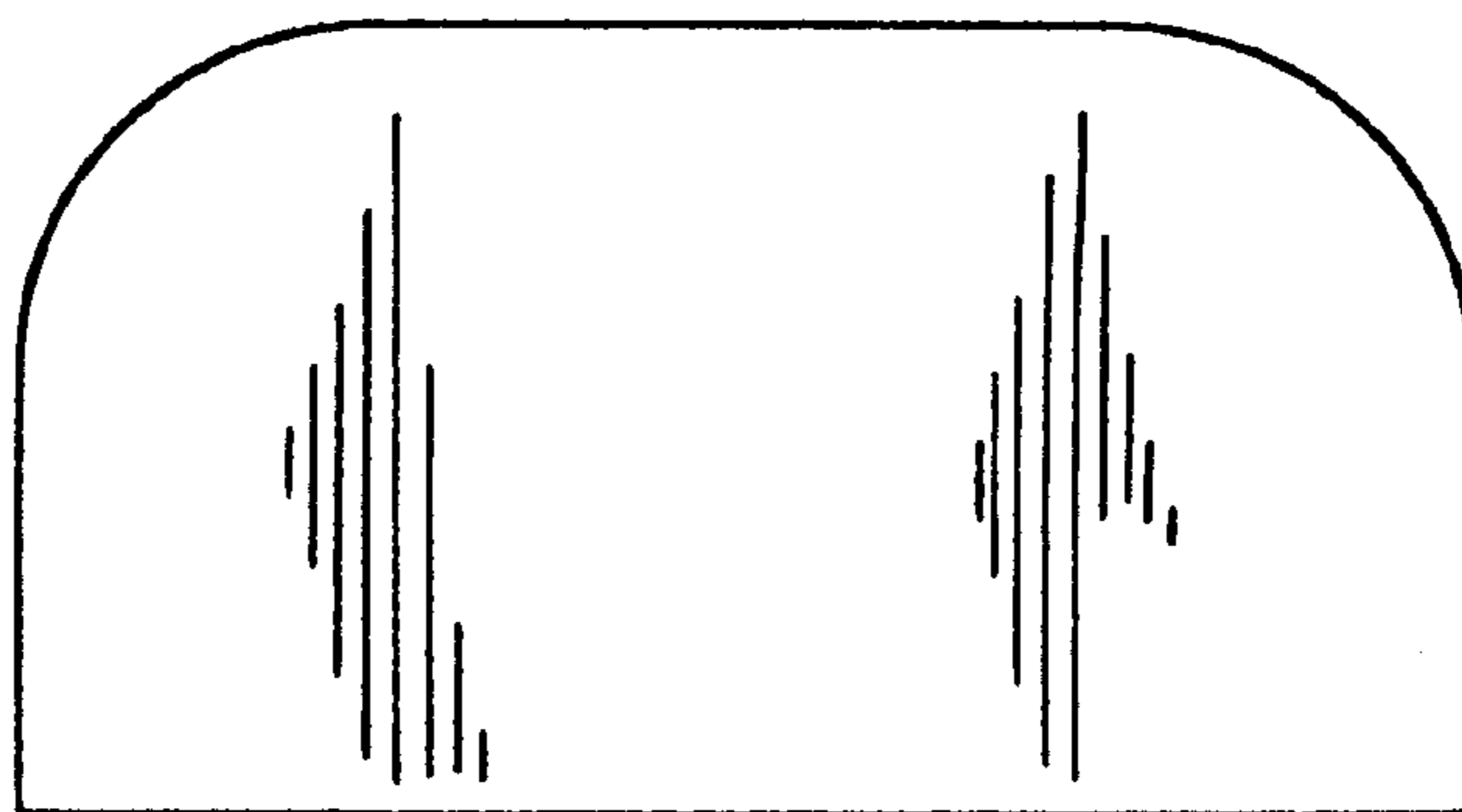

FIG. 46

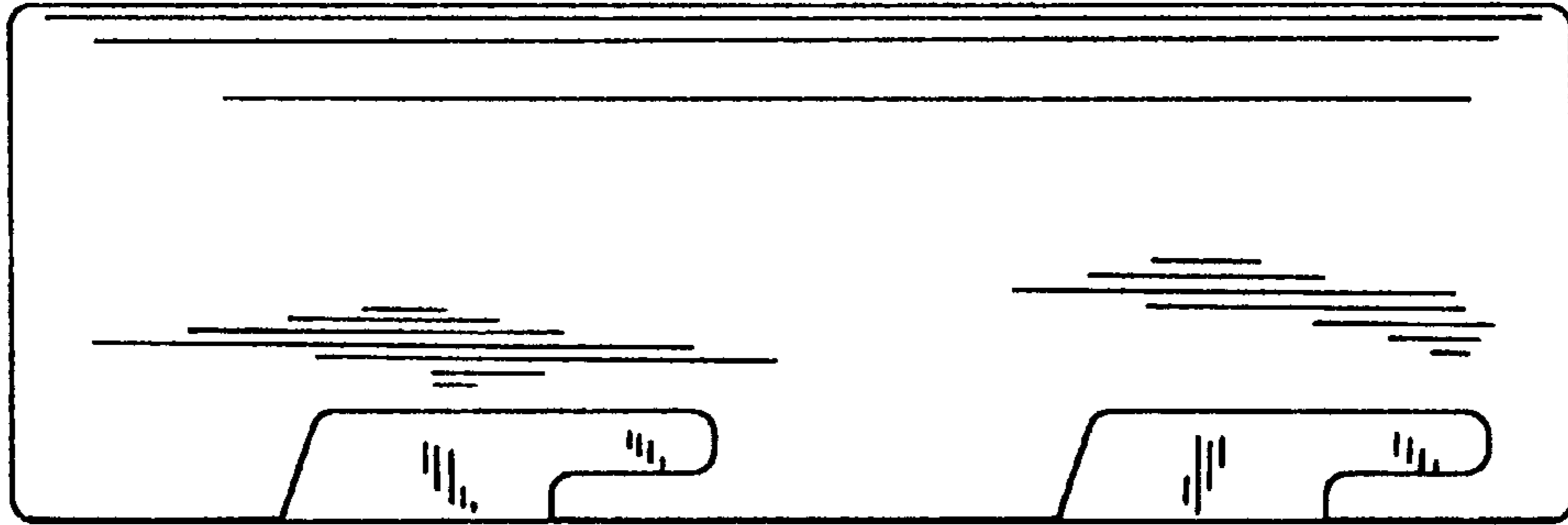

FIG. 49

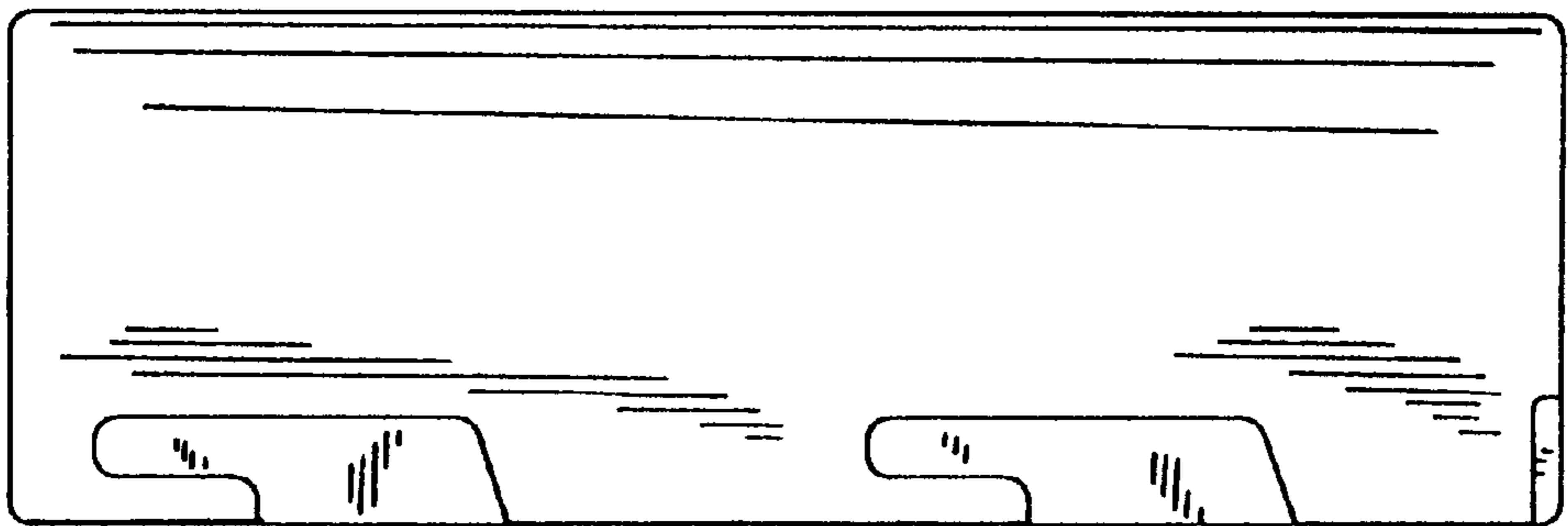

FIG. 50

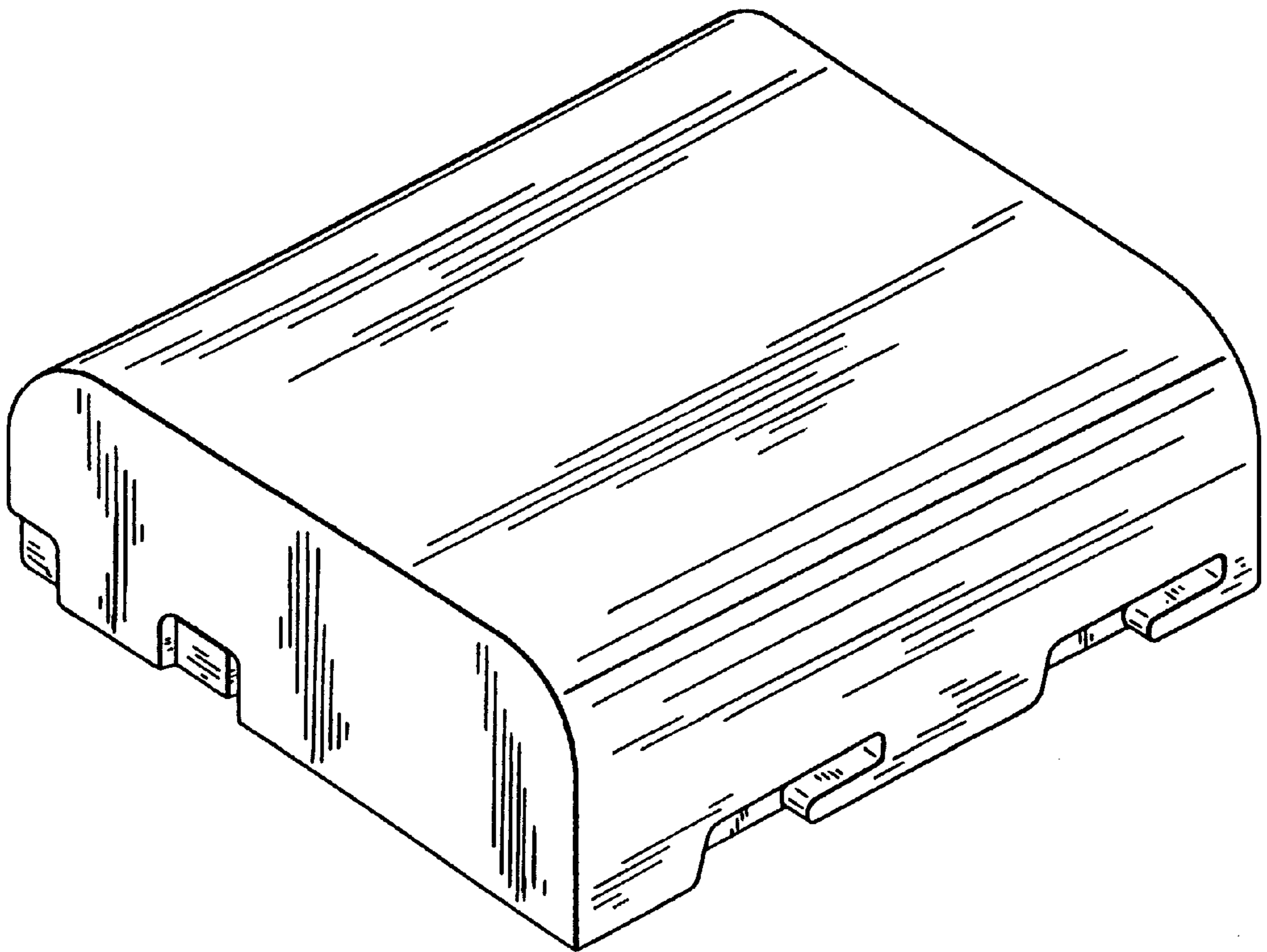

FIG. 51

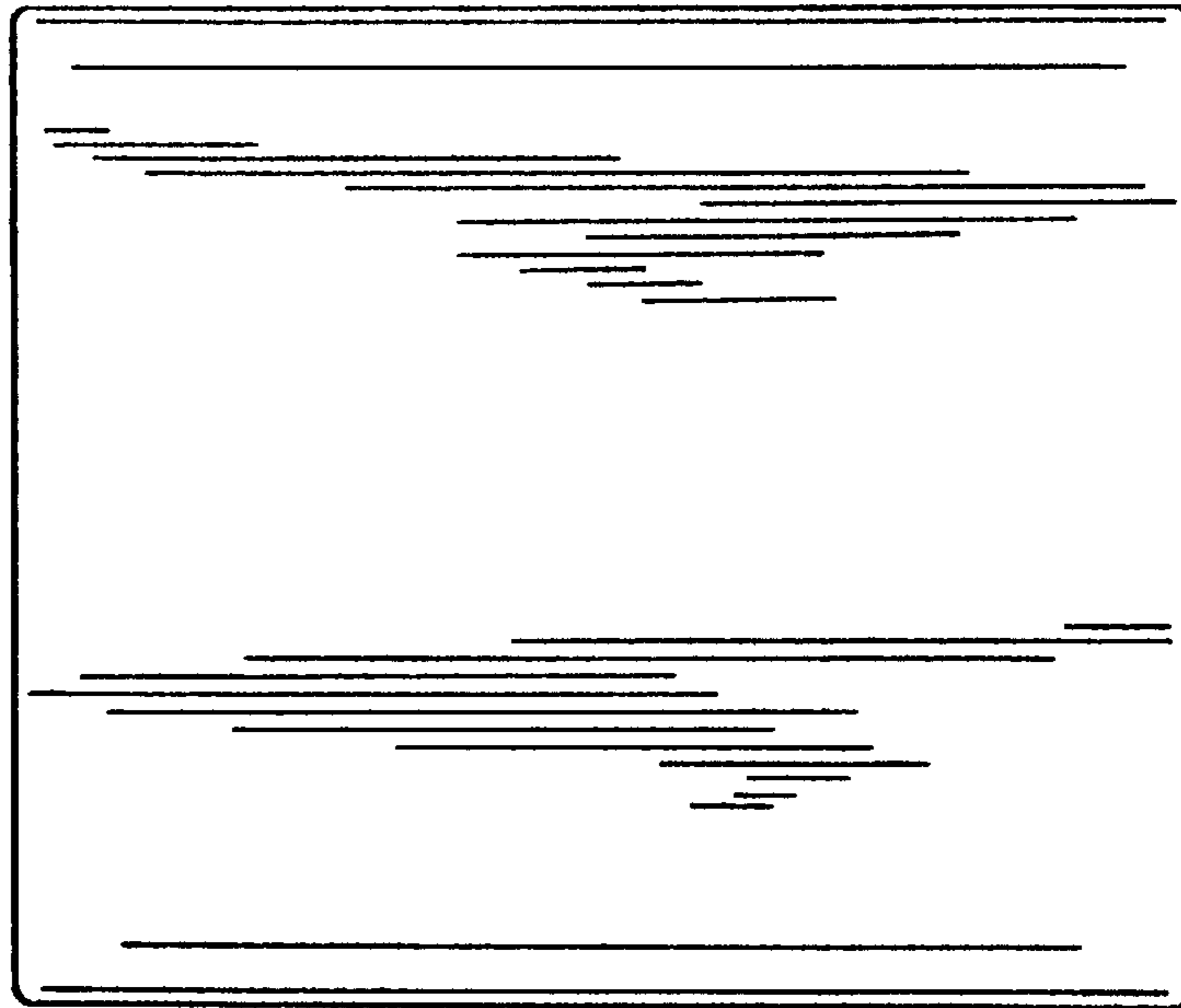

FIG. 54

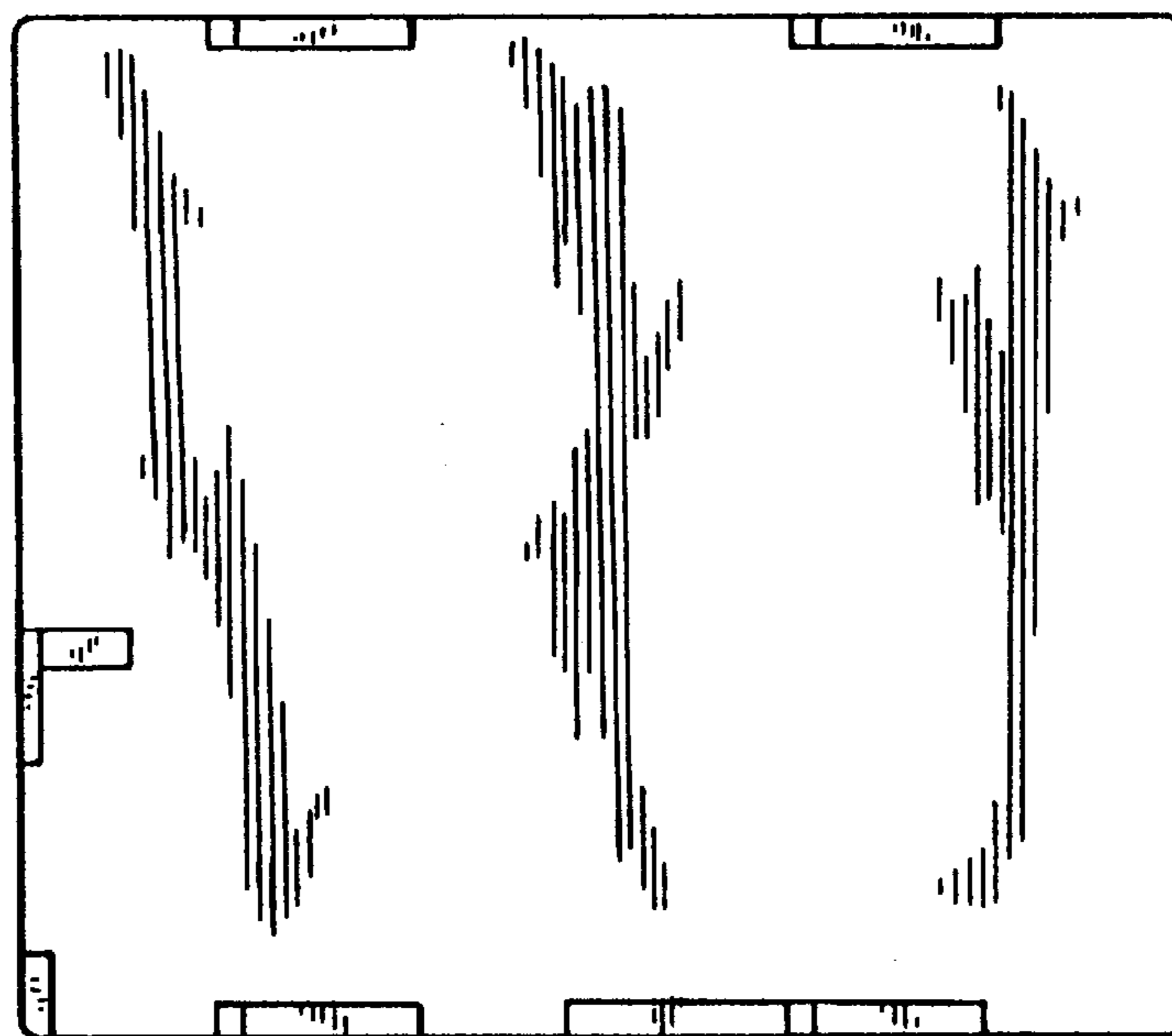

FIG. 52

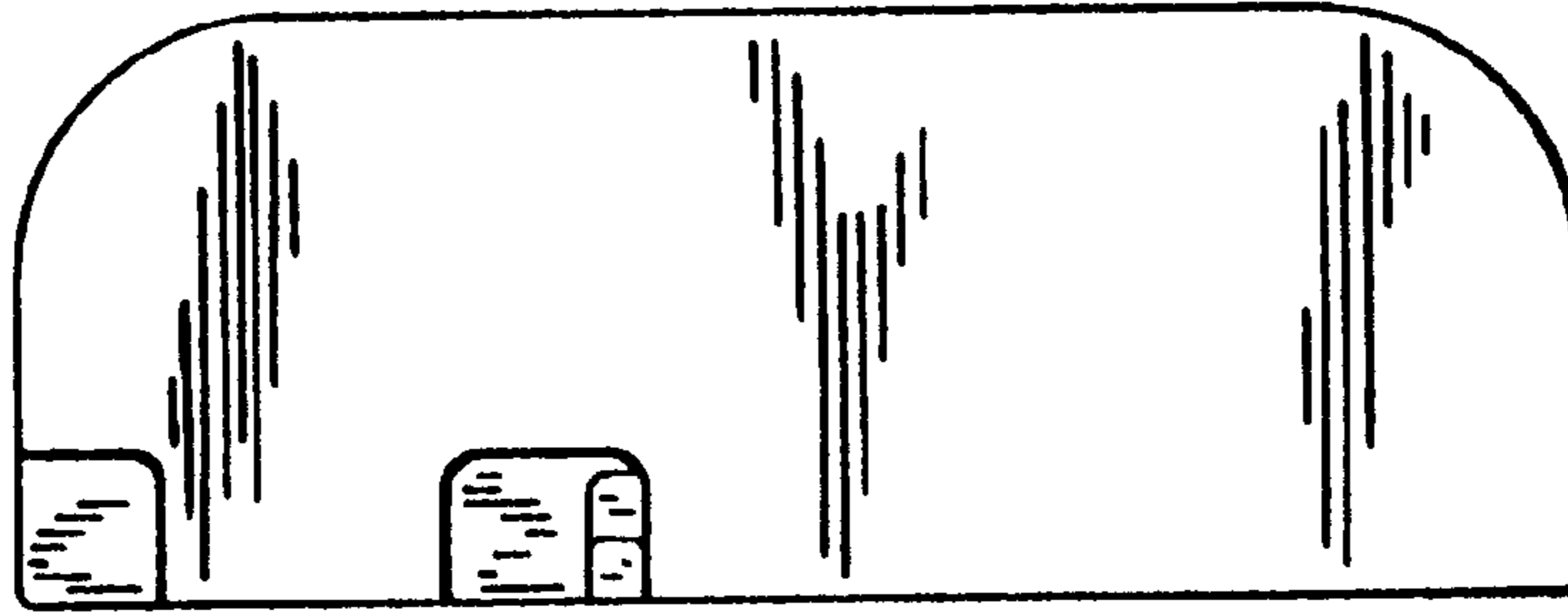

FIG. 55

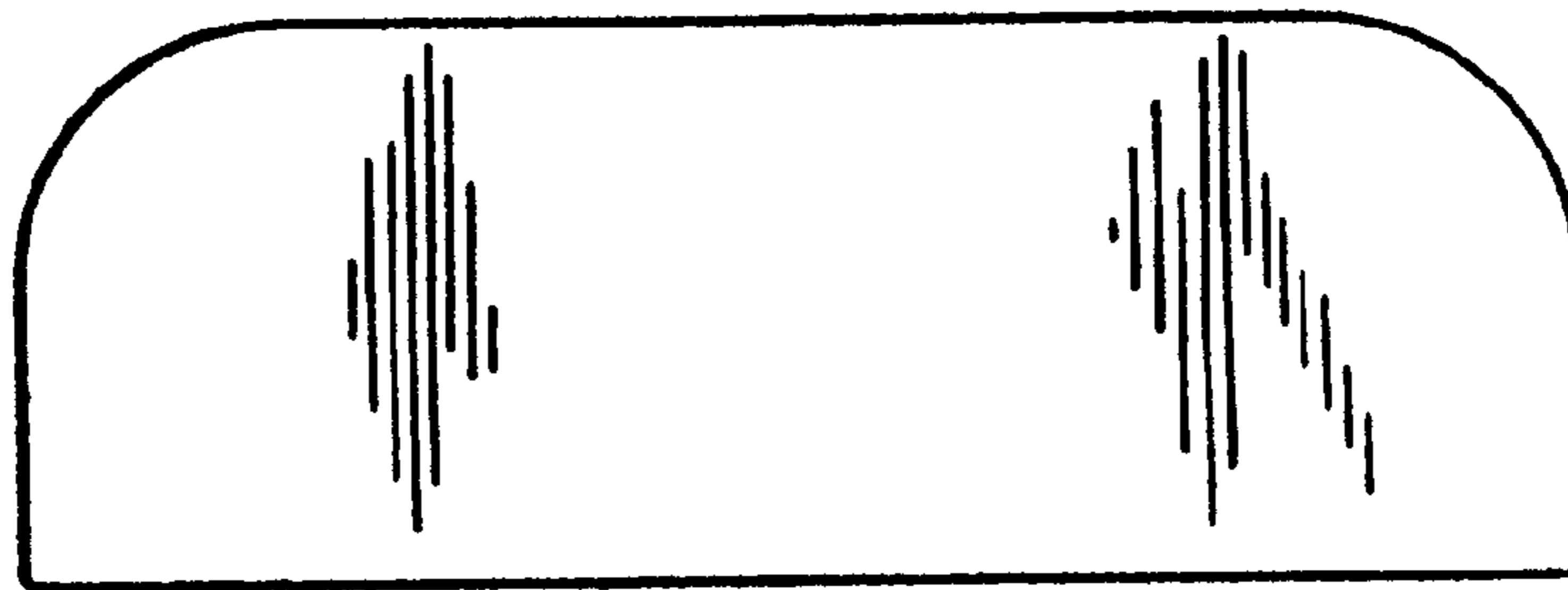

FIG. 53

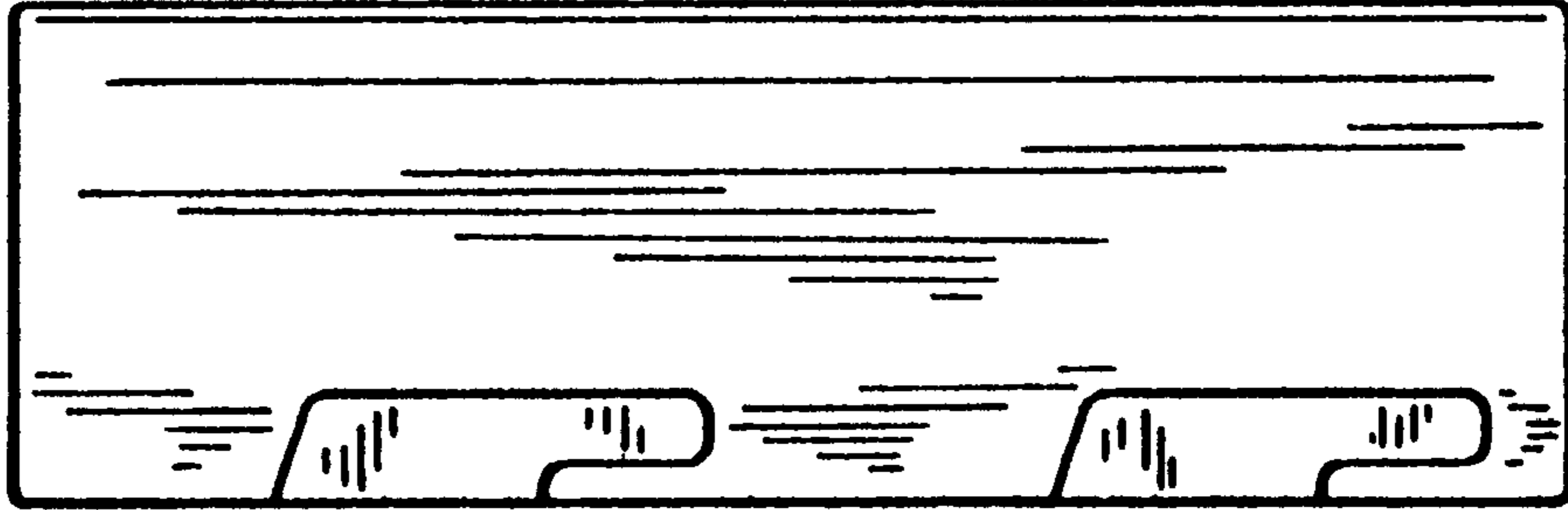

FIG. 56

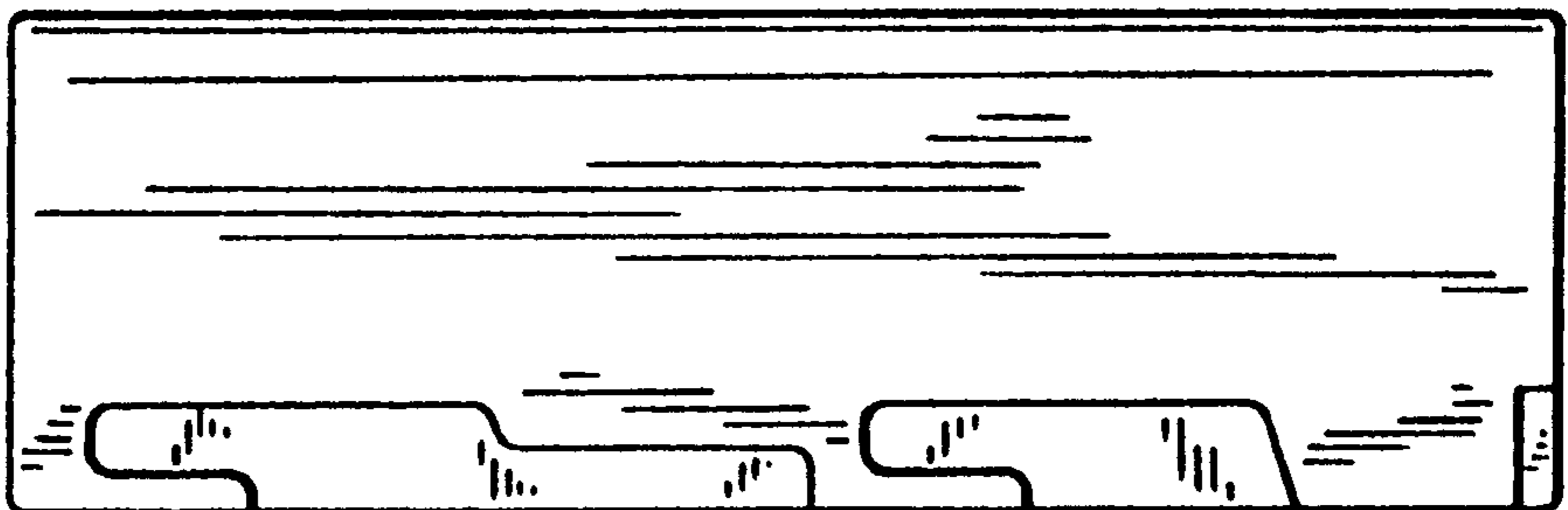

FIG. 57

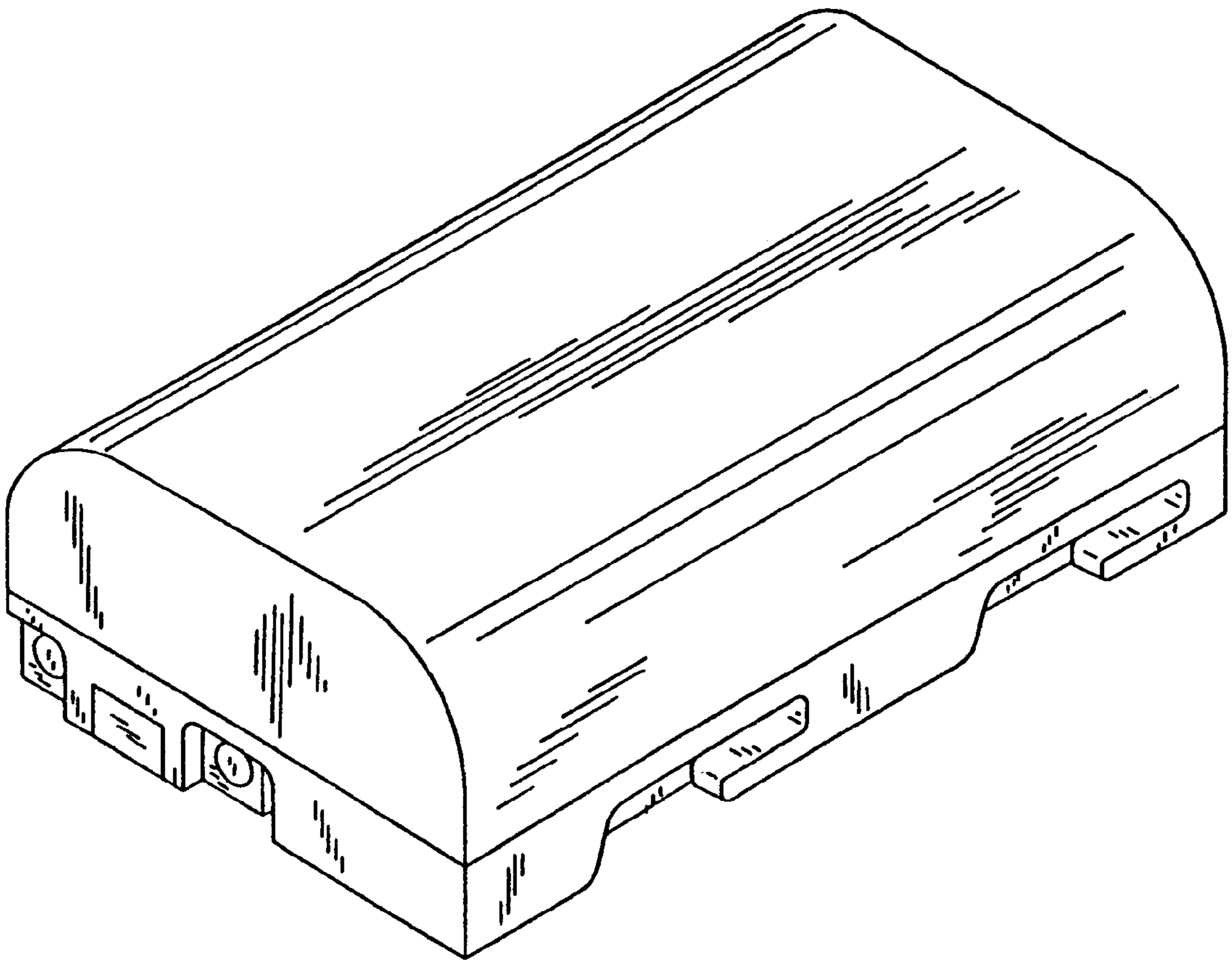

FIG. 58

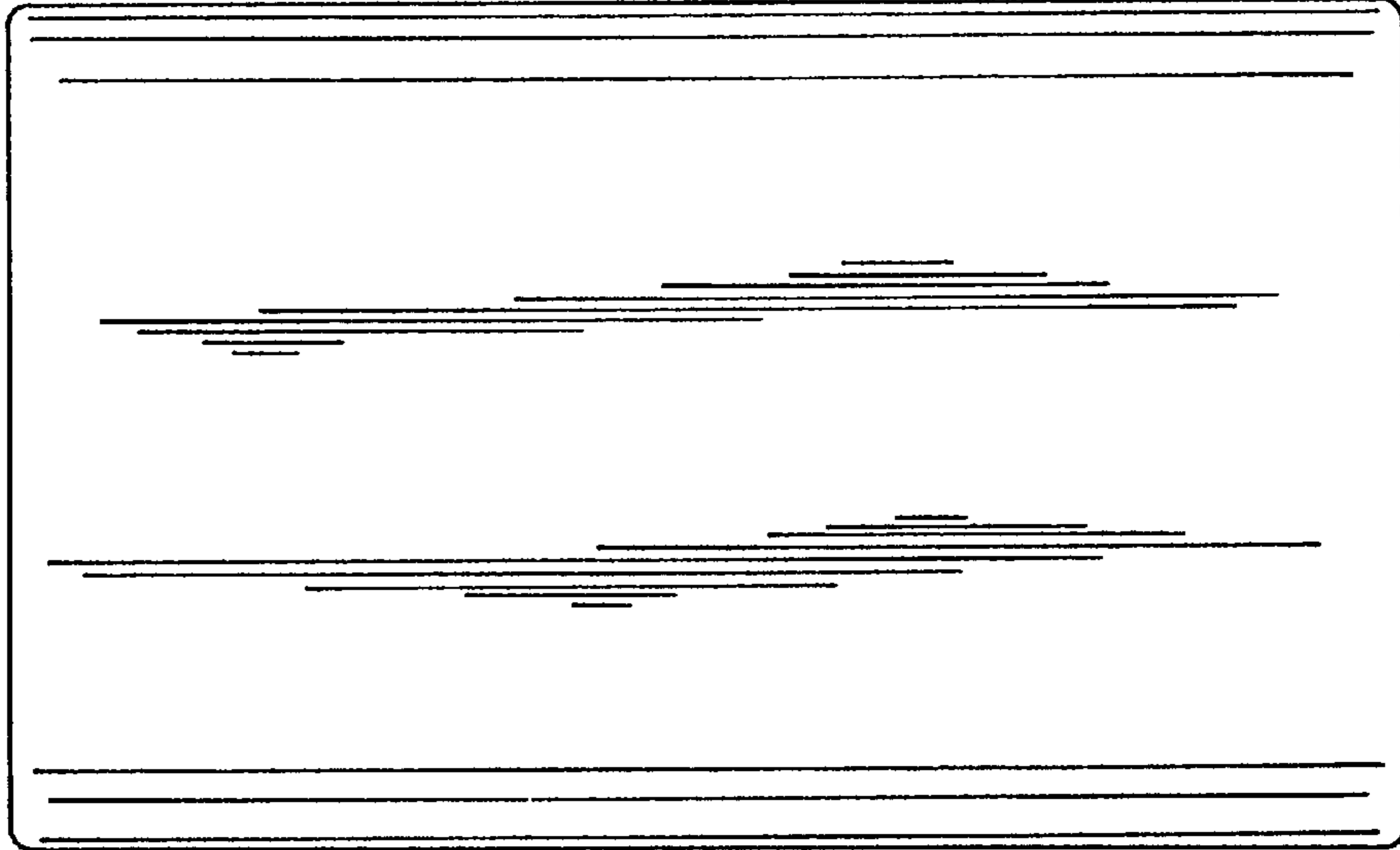

FIG. 61

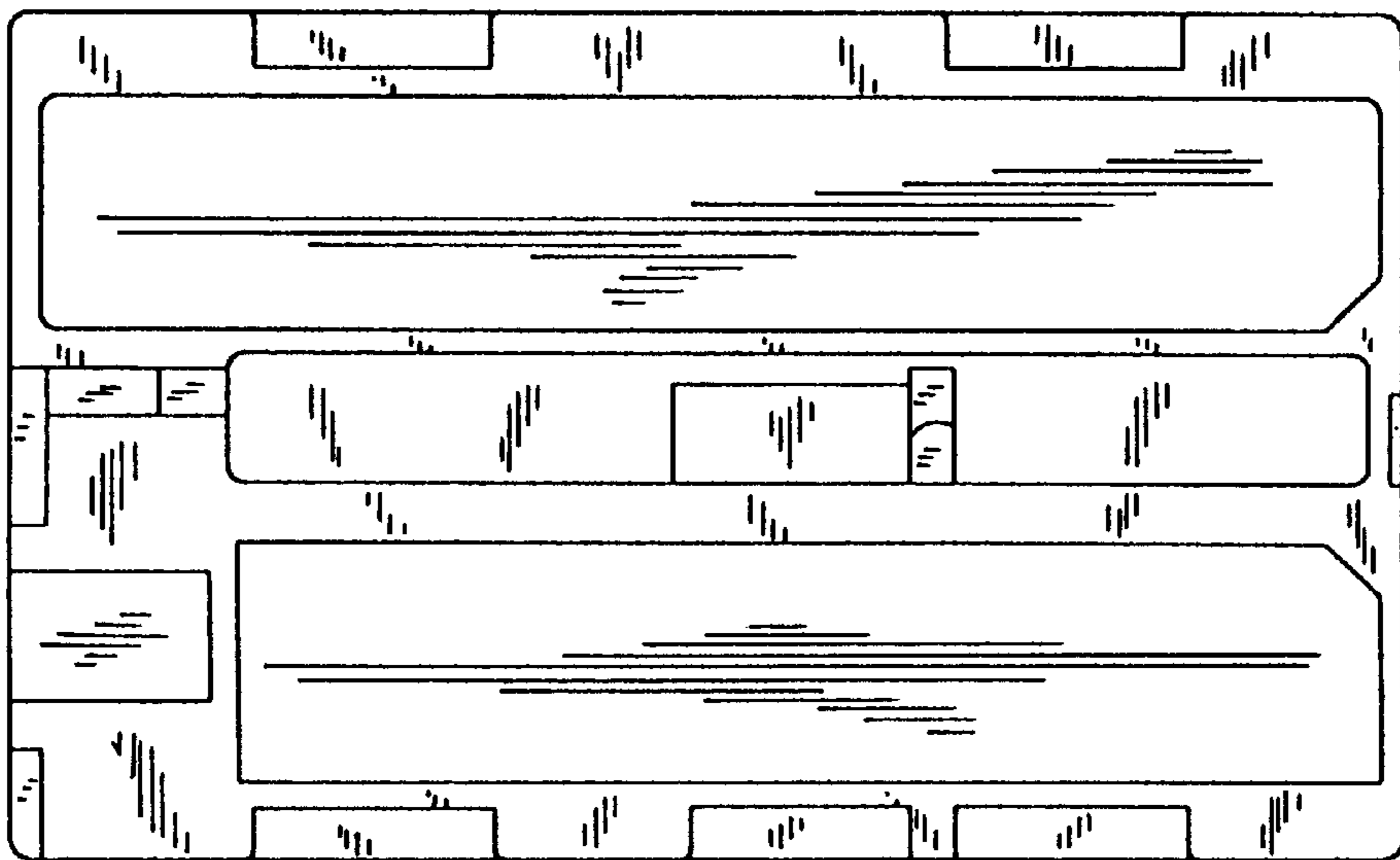

FIG. 59

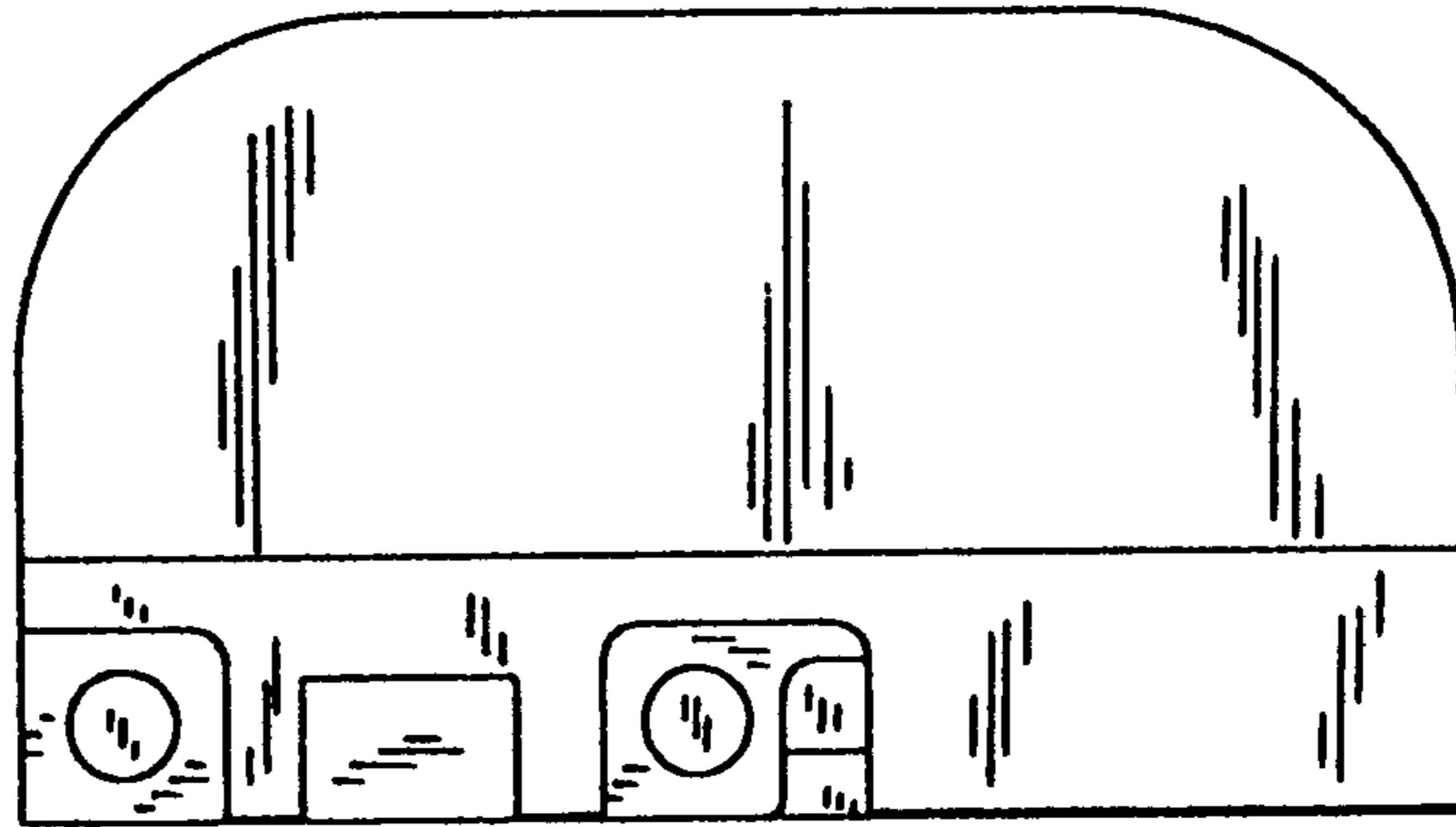

FIG. 62

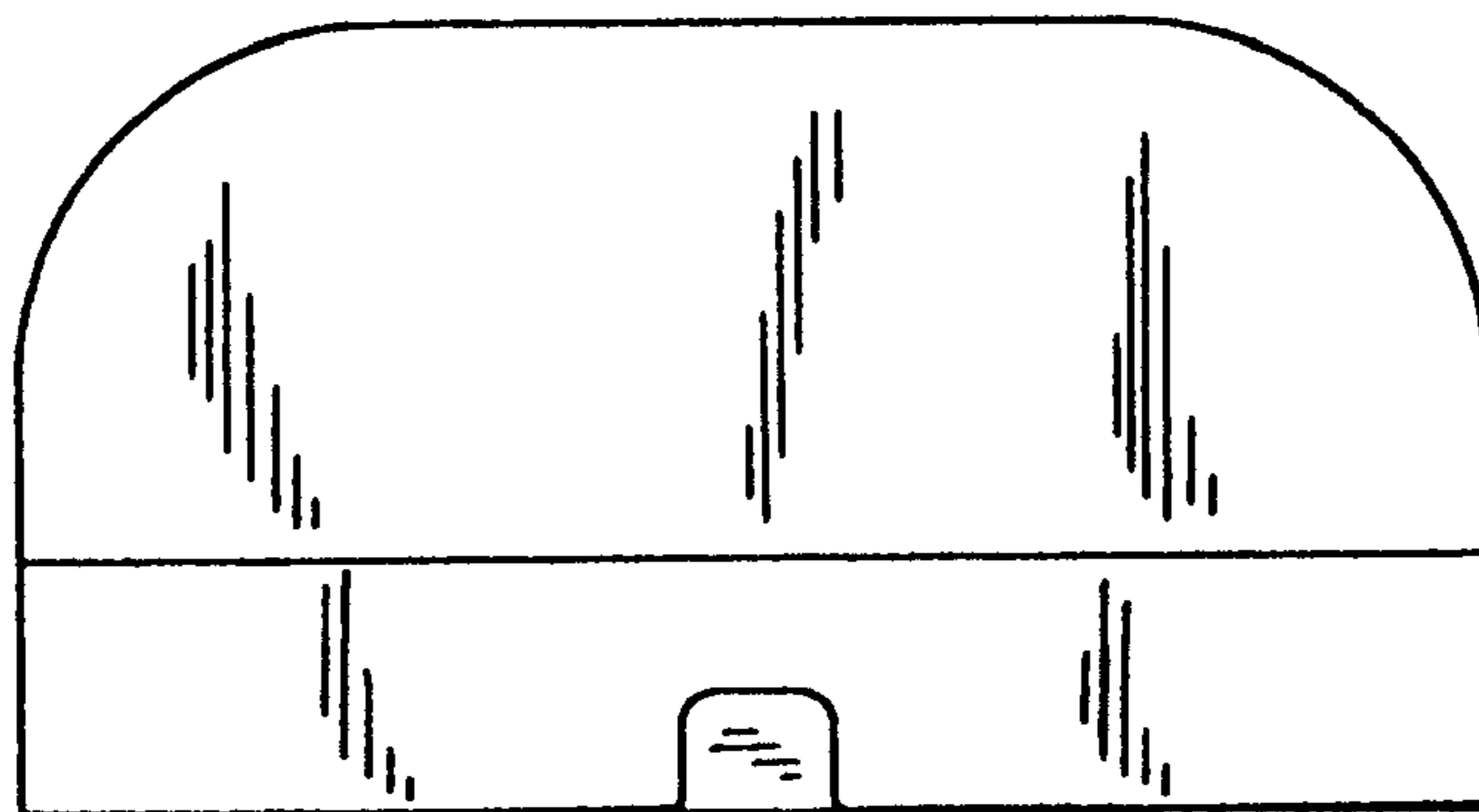

FIG. 60

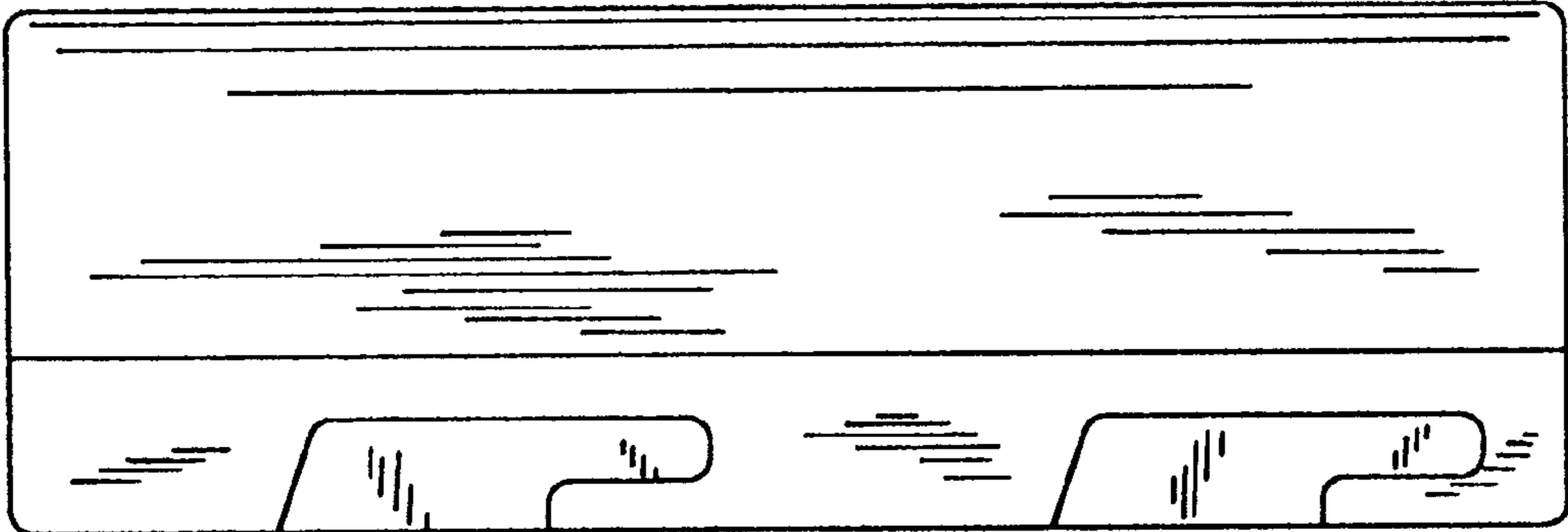

FIG. 63

