



US00D428338S

United States Patent [19]

Iizuka et al.

[11] Patent Number: Des. 428,338

[45] Date of Patent: ** Jul. 18, 2000

[54] CONTAINER WITH HANDLE

[75] Inventors: Takao Iizuka, Matsudo; Tetsuo Takahashi, Soka, both of Japan; Raymond A. Bourque, Plymouth; Ralph T. Coley, Jr., Cohasset, both of Mass.

[73] Assignees: Yoshino Kogyosho Co., Ltd, Tokyo, Japan; Ocean Spray Cranberries, Inc., Lakeville-Middleboro, Mass.

[**] Term: 14 Years

[21] Appl. No.: 29/107,732

[22] Filed: Jul. 14, 1999

[51] LOC (7) Cl. 09-01

[52] U.S. Cl. D9/434

[58] Field of Search D9/424, 428, 431, D9/500, 503-504, 506, 508, 510-516, 520, 523-524, 527-528, 530-531, 533; 215/382-386, 396, 398; 220/771

[56] References Cited

U.S. PATENT DOCUMENTS

- D. 318,229 7/1991 Umetsu .
- D. 333,098 2/1993 Hestehave et al. D9/531
- D. 344,457 2/1994 Prevot et al. D9/537
- D. 359,449 6/1995 Ota et al. D9/434
- D. 366,416 1/1996 Semersky D9/520
- D. 366,831 2/1996 Smersky et al. D9/520
- D. 390,114 2/1998 Young D9/520
- D. 397,614 9/1998 Krishnakumar et al. D9/520
- D. 402,895 12/1998 Takahashi et al. D9/520
- D. 404,308 1/1999 Takahashi et al. D9/520
- D. 405,690 2/1999 Takahashi et al. D9/434
- D. 405,691 2/1999 Takahashi et al. D9/434
- D. 407,650 4/1999 Takahashi et al. D9/520
- D. 411,453 6/1999 Piccioli et al. D9/520
- D. 413,519 9/1999 Eberle et al. D9/538
- D. 414,109 9/1999 Ota et al. D9/434
- D. 414,116 9/1999 Bourque et al. D9/434
- 3,140,329 7/1964 Nutting .
- 4,257,525 3/1981 Thompson .
- 4,273,246 6/1981 Thompson .
- 4,281,770 8/1981 Rainville .

- 4,363,415 12/1982 Rainville .
- 4,629,598 12/1986 Thompson .
- 4,727,997 3/1988 Nakamura et al. .
- 4,909,978 3/1990 Hasegawa et al. .
- 4,915,241 4/1990 Morimura et al. .
- 4,952,133 8/1990 Hasegawa et al. .
- 4,964,522 10/1990 Umetsu et al. .

(List continued on next page.)

FOREIGN PATENT DOCUMENTS

- 0 650 900 A1 5/1995 European Pat. Off. .
- 889343 2/1962 United Kingdom .

Primary Examiner—Ted Shooman
Assistant Examiner—Carol Rademaker
Attorney, Agent, or Firm—Oliff & Berridge, PLC

[57] CLAIM

The ornamental design for container with handle, as shown and described.

DESCRIPTION

FIG. 1 is a rear view of the container with handle;
 FIG. 2 is a side view thereof, the opposite side being a mirror image thereof;
 FIG. 3 is a front view thereof;
 FIG. 4 is a top view thereof;
 FIG. 5 is a bottom view thereof;
 FIG. 6 is an enlarged front view of the handle of FIG. 3 without the container;
 FIG. 7 is a side view thereof, the opposite side view being a mirror image thereof;
 FIG. 8 is a rear view thereof;
 FIG. 9 is a top view thereof; and,
 FIG. 10 is a bottom view thereof.

The broken line portions of the container shown in FIGS. 1-5 and of the broken lines shown on the handle in FIGS. 6 and 7 are for illustrative purposes only and form no part of the claimed design. The handle is enlarged and shown separately in FIGS. 6-10 for clarity of illustration.

1 Claim, 6 Drawing Sheets

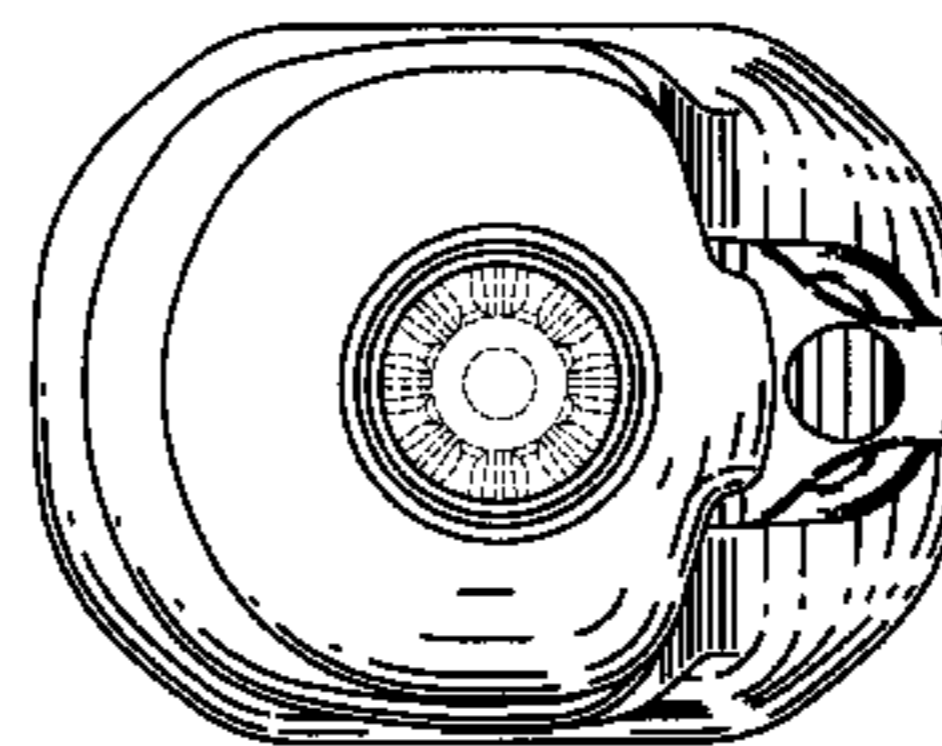
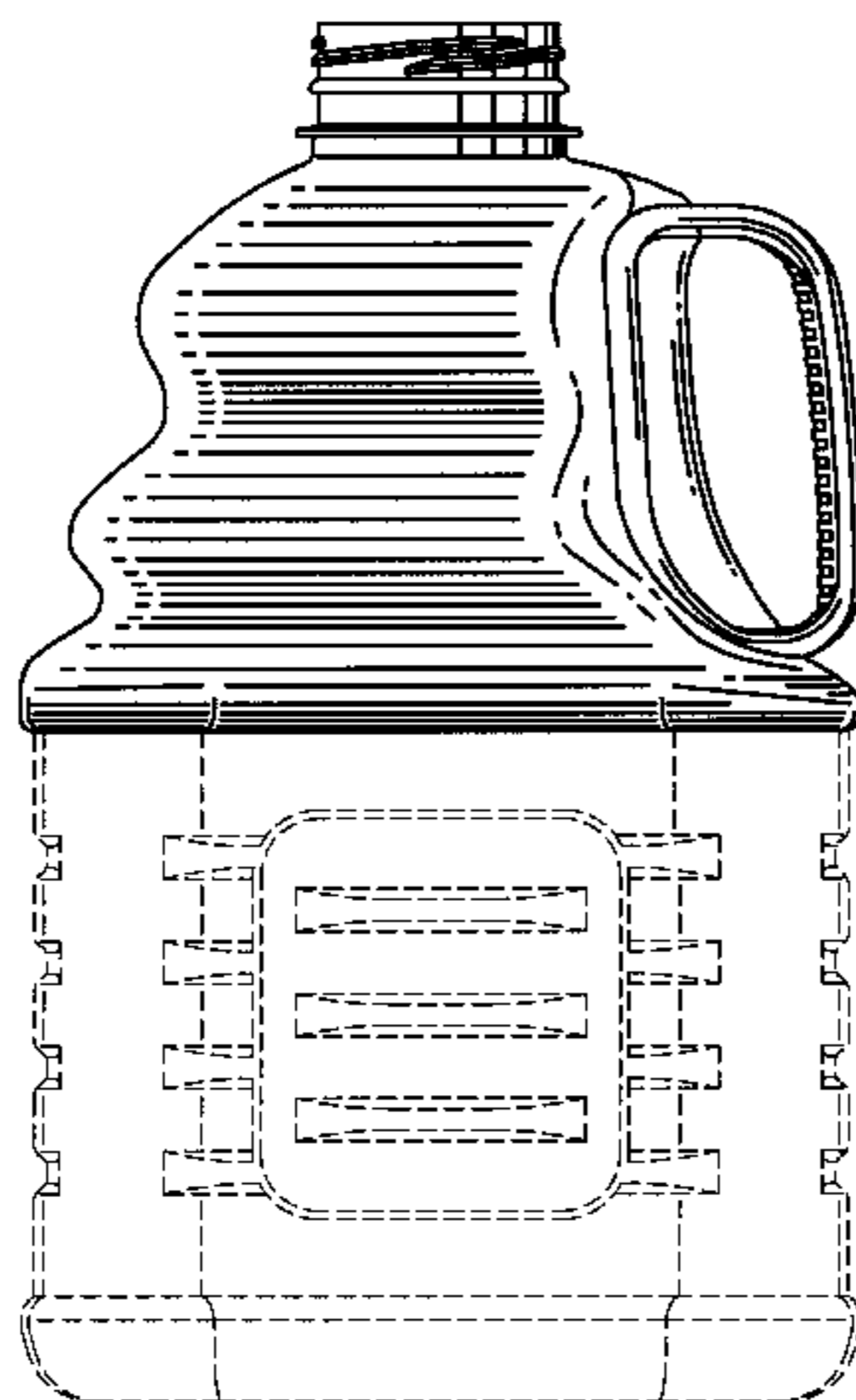

Des. 428,338

Page 2

U.S. PATENT DOCUMENTS

5,092,476	3/1992	Yasuda et al.	215/398	5,535,901	7/1996	Ishii et al.	215/396
5,167,970	12/1992	Yoshino et al.	215/398	5,560,506	10/1996	Yanagisawa et al. .	
5,297,686	3/1994	Takeuchi .		5,637,167	6/1997	Krishnakumar et al.	215/396
5,338,503	8/1994	Yanagisawa et al. .		5,704,506	1/1998	Tobias et al.	215/398
5,407,086	4/1995	Ota et al.	215/383	5,758,790	6/1998	Ewing, Jr.	215/384
5,469,612	11/1995	Collette et al. .		5,918,754	7/1999	Lyons et al.	215/396
				5,988,418	11/1999	Maeshima	215/396

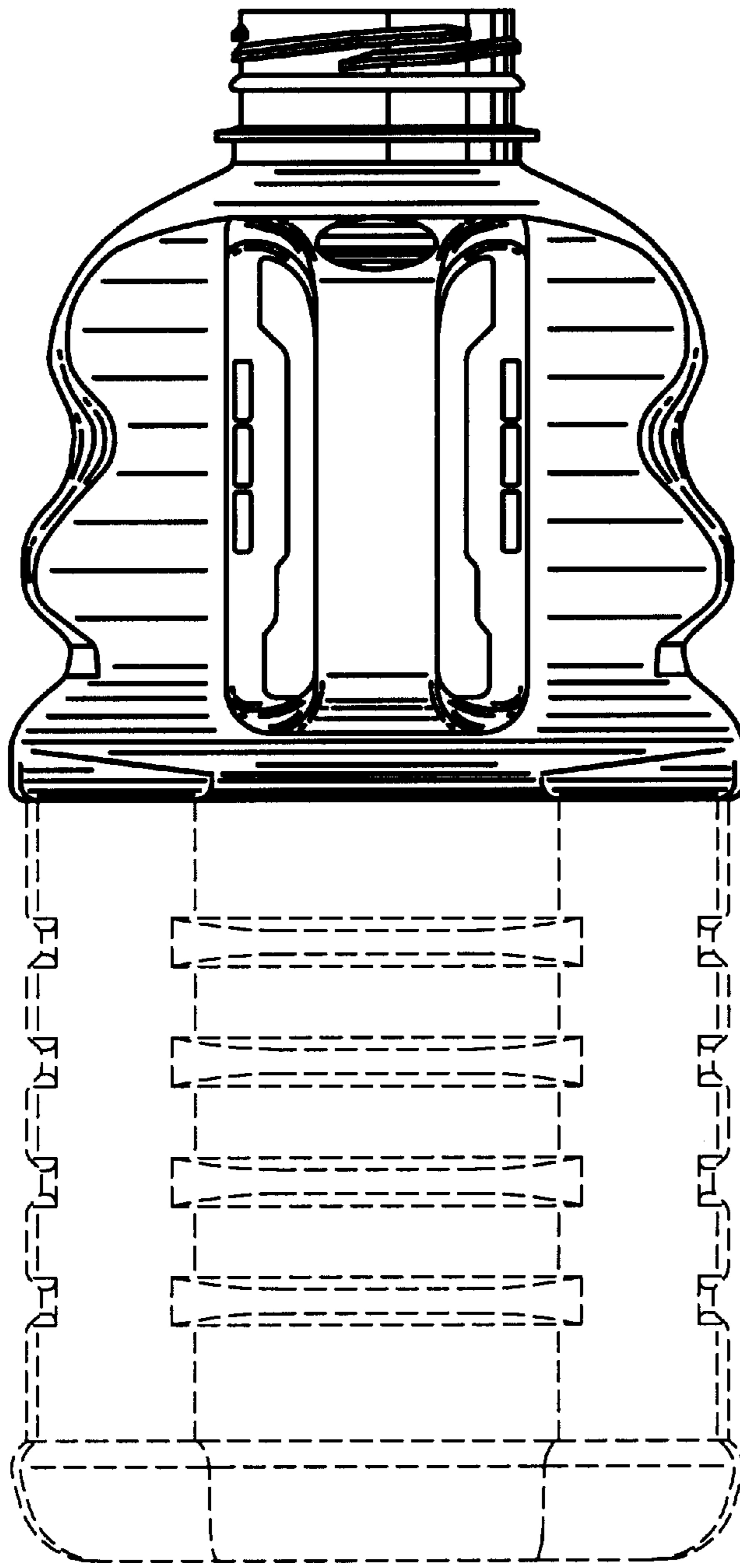

FIG 1

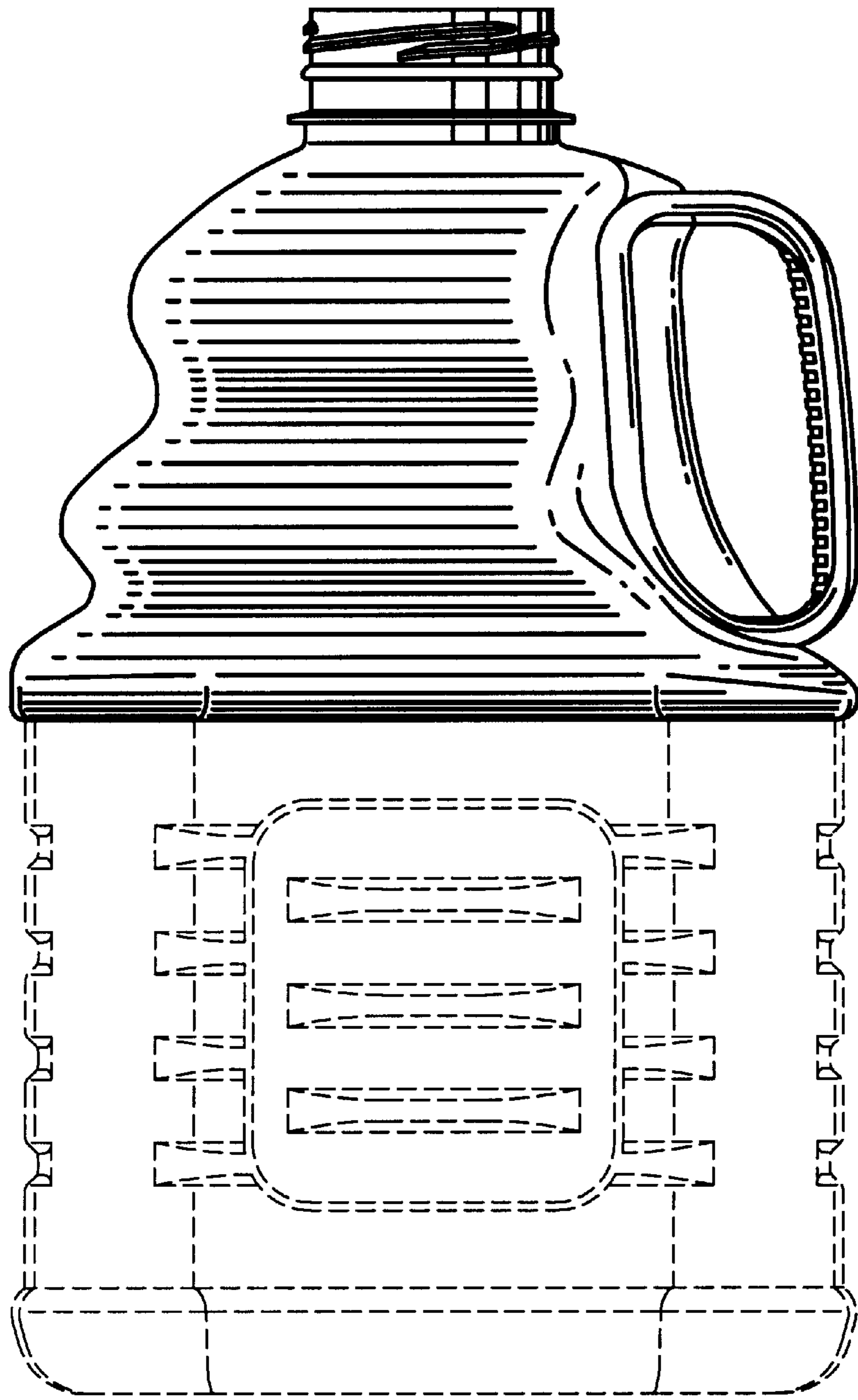

FIG 2

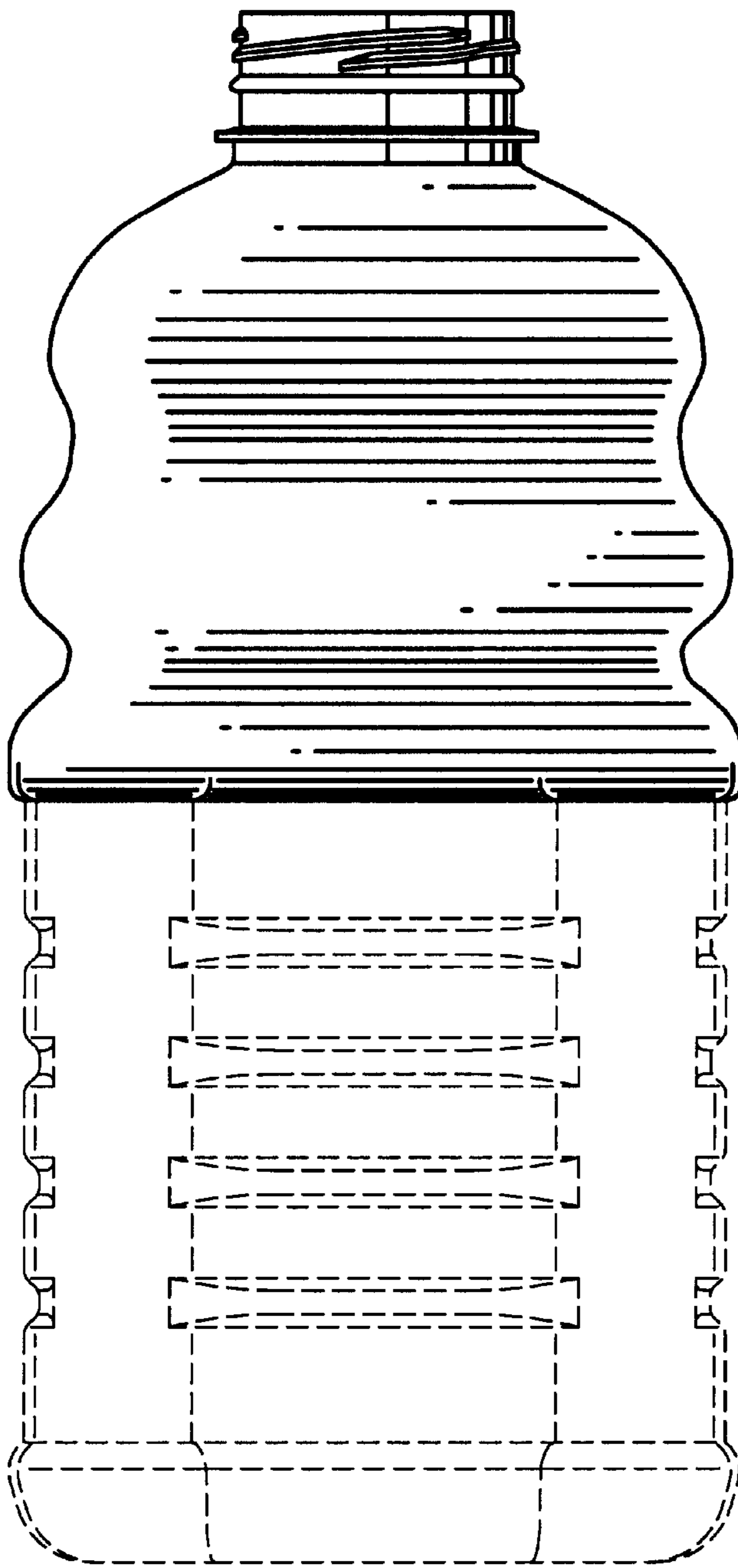

FIG 3

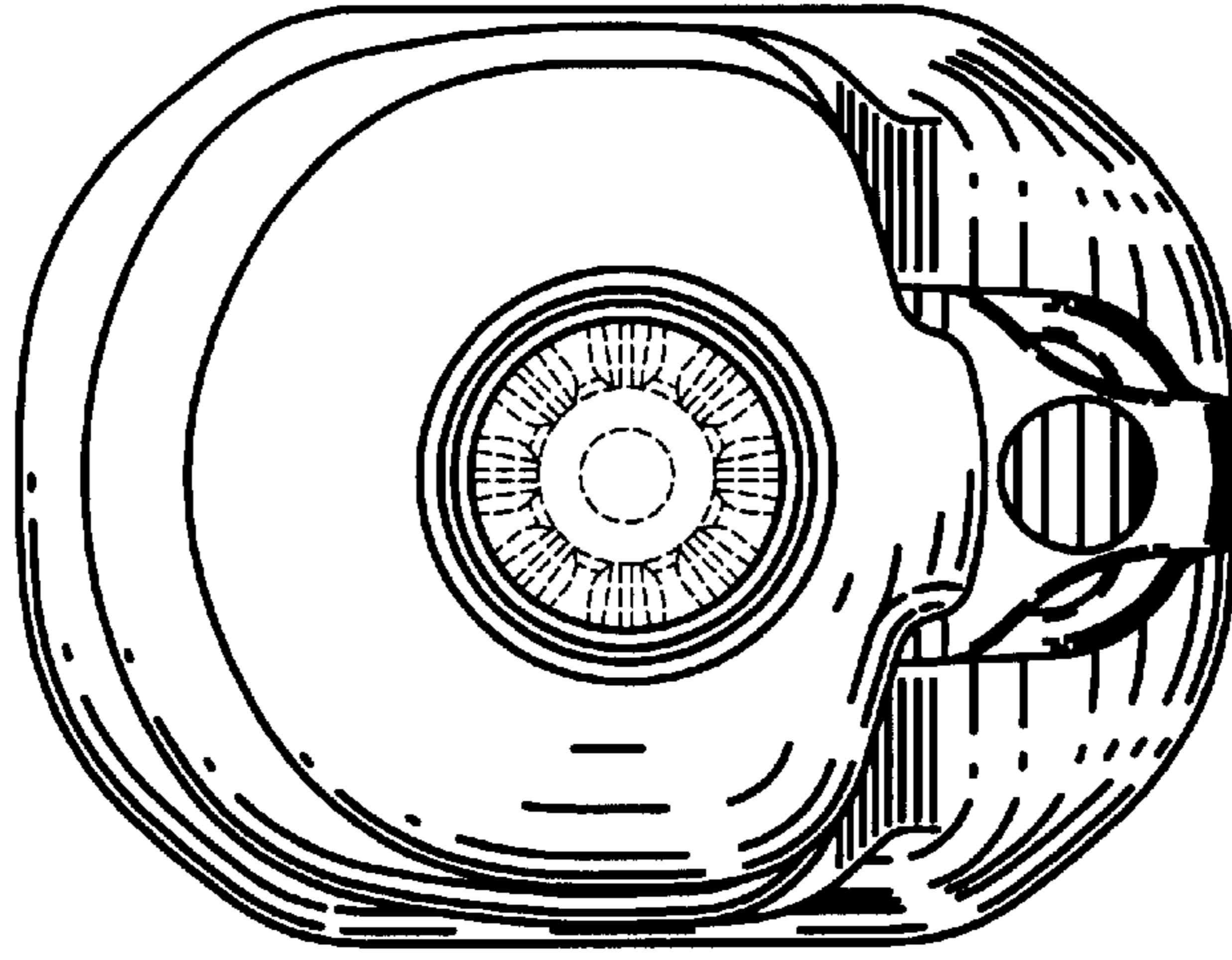

FIG 4

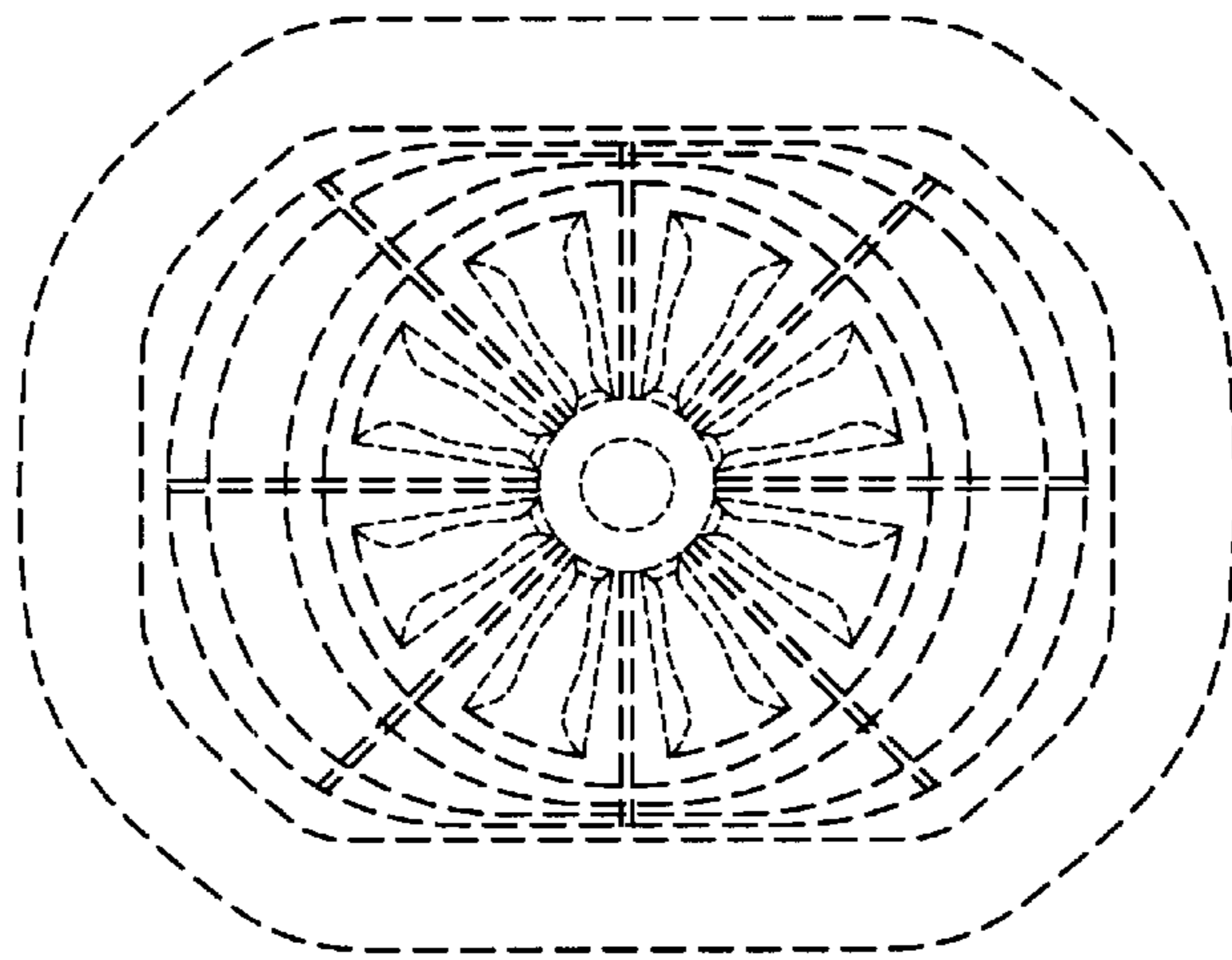

FIG 5

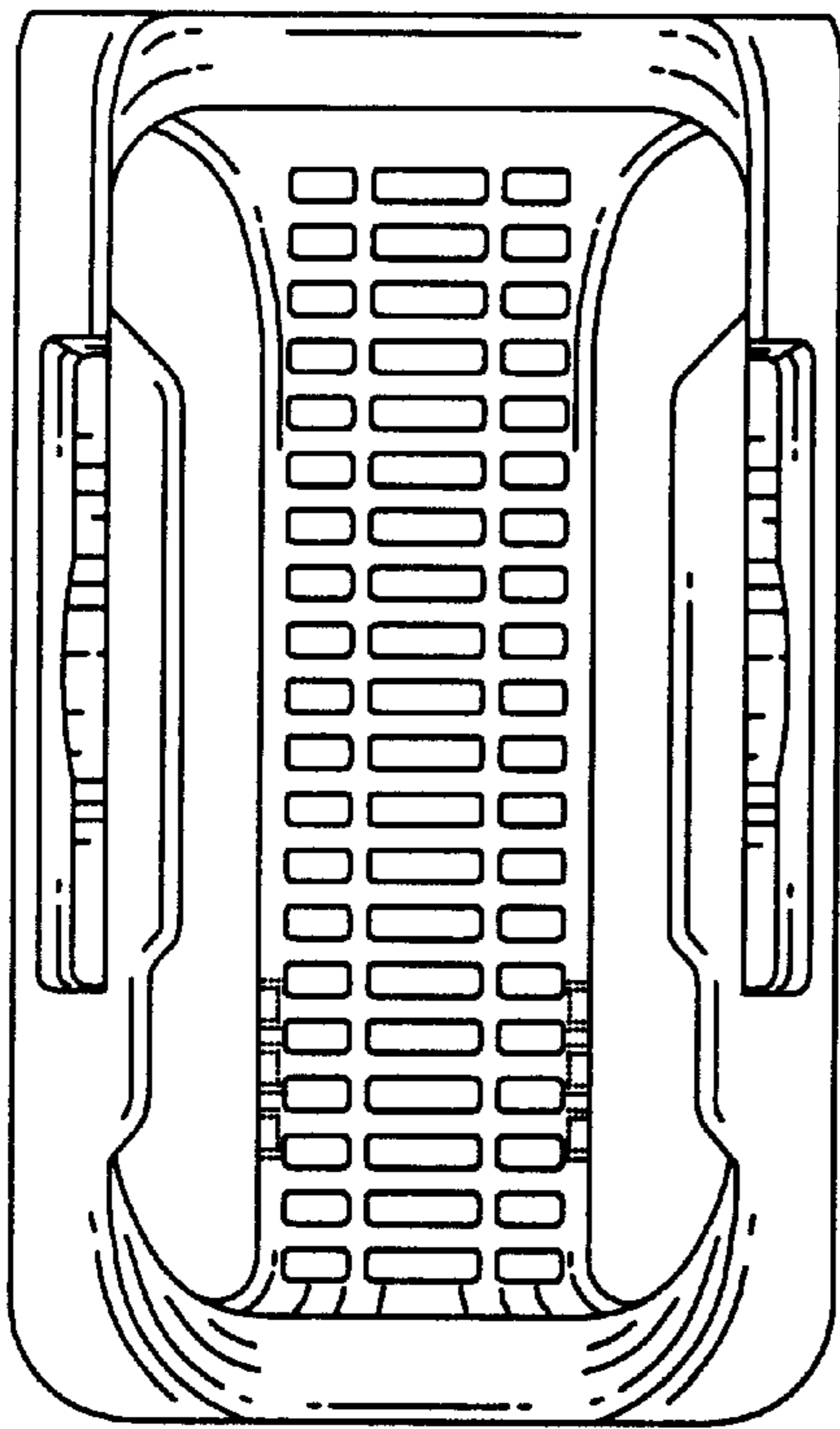

FIG 6

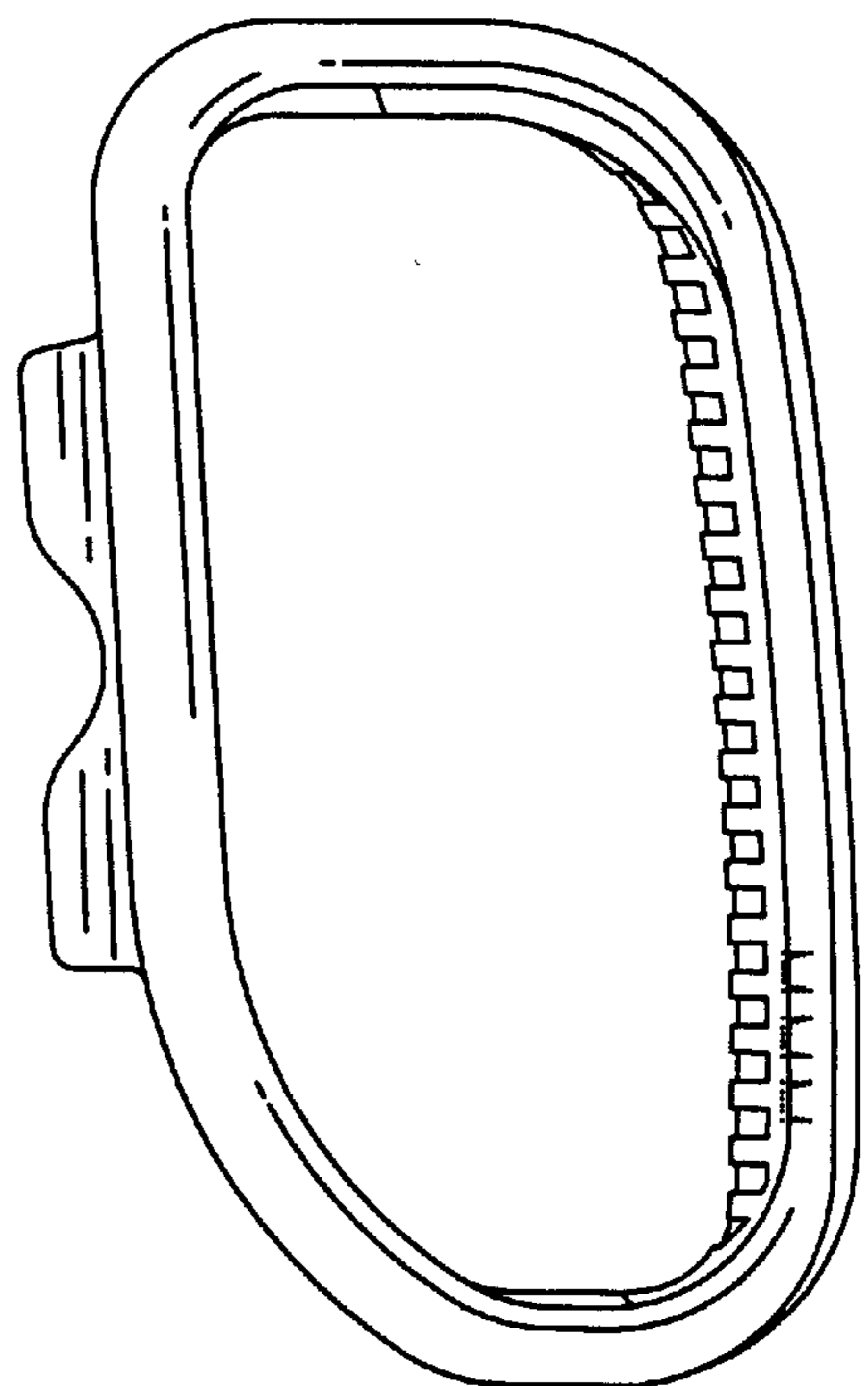

FIG 7

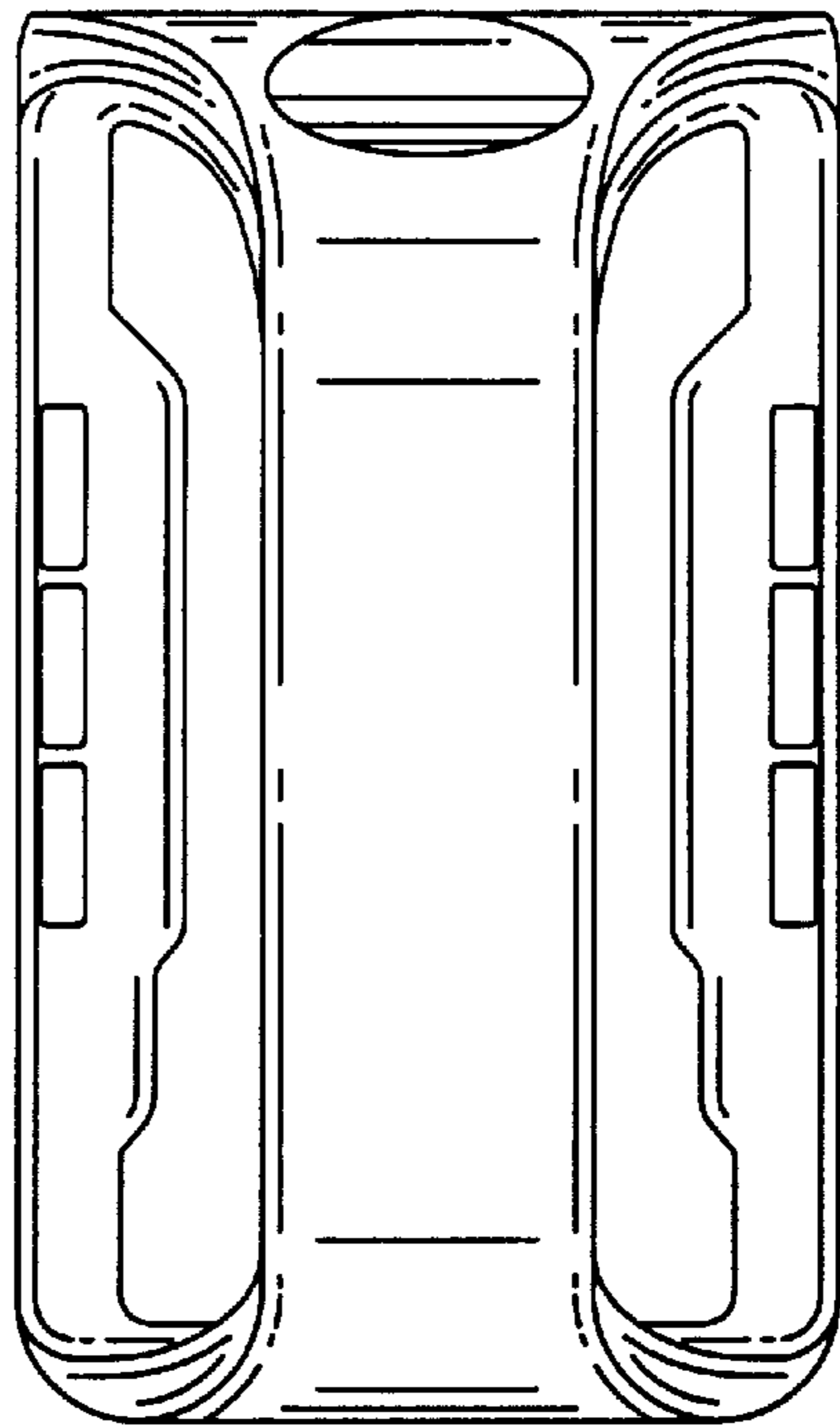

FIG 8

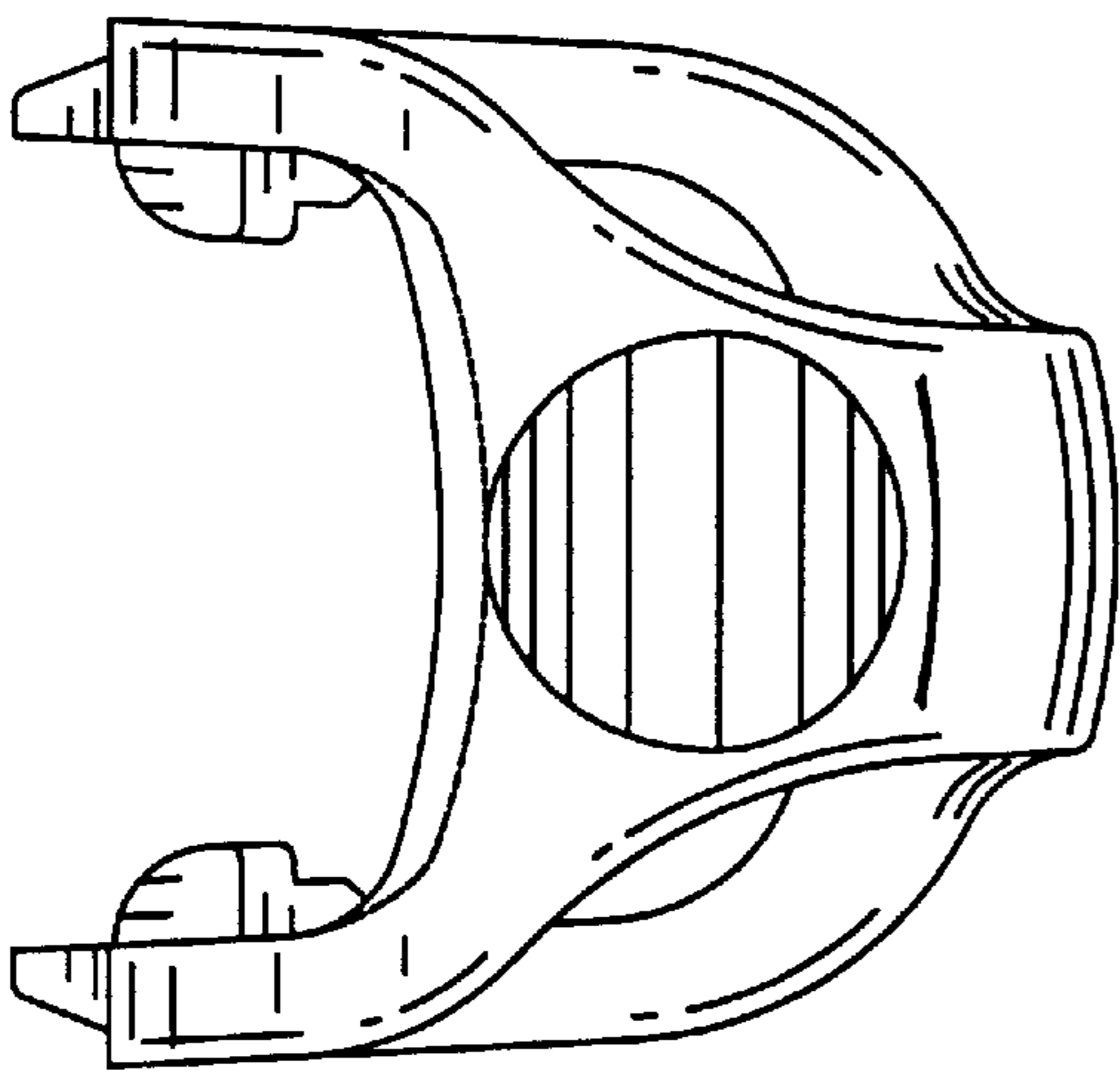

FIG 9

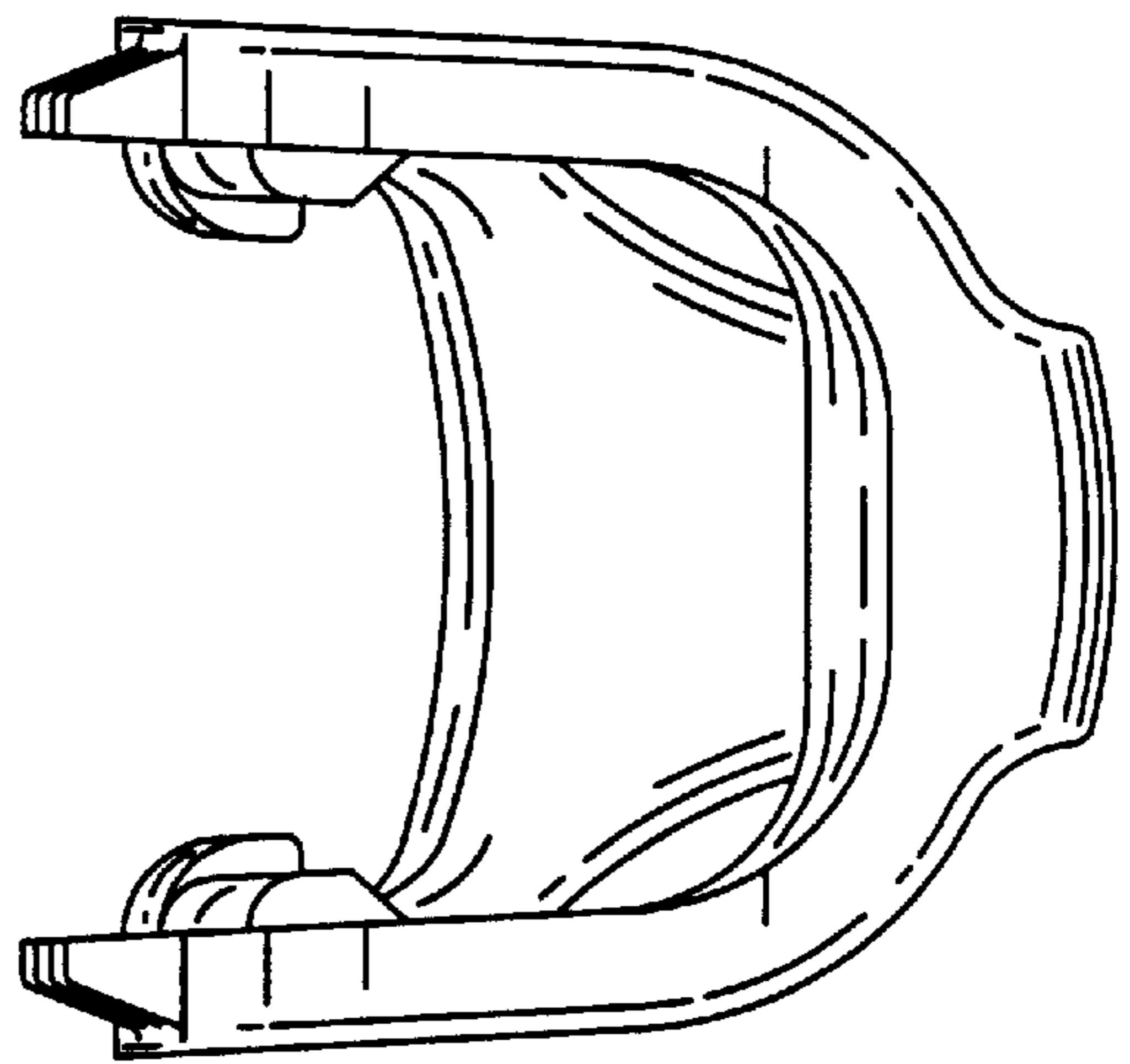

FIG 10