



US00D428302S

# United States Patent [19] Miller

[11] Patent Number: **Des. 428,302**

[45] Date of Patent: **\*\* Jul. 18, 2000**

[54] **ITEM RETAINER FOR MODULAR SERVING STAND**

[75] Inventor: **D. Scott Miller**, Orlando, Fla.

[73] Assignee: **Dart Industries Inc.**, Orlando, Fla.

[\*\*] Term: **14 Years**

[21] Appl. No.: **29/093,512**

[22] Filed: **Sep. 11, 1998**

[51] **LOC (7) Cl.** ..... **07-99**

[52] **U.S. Cl.** ..... **D7/396.1; D7/396.2; D7/602; D7/619; D7/624; D11/152**

[58] **Field of Search** ..... **D7/619, 620, 621, D7/622, 624, 396.2, 387, 388, 392.1, 396.1, 396.6, 507, 505, 534, 504, 601, 602; 248/346.11, 311.2; 220/669; 224/926; 215/395; D11/143, 152; 211/85.4**

[56] **References Cited**

**U.S. PATENT DOCUMENTS**

- D. 130,014 10/1941 Blatz ..... D7/507
- D. 192,814 5/1962 Sinaiku ..... D7/619
- D. 197,618 3/1964 Milbourne et al. .... D7/507

- D. 324,004 2/1992 Neill ..... D11/152
- D. 327,392 6/1992 Conder, Jr. .... D7/504
- D. 376,728 12/1996 Richards, Sr. et al. .... D7/507
- 3,491,976 1/1970 Larson ..... 248/346.11
- 5,065,870 11/1991 Conder, Jr. .... 211/85.4
- 5,154,380 10/1992 Risca ..... 248/311.2 X
- 5,533,700 7/1996 Porter ..... 248/311.2

*Primary Examiner*—M. N. Pandozzi  
*Attorney, Agent, or Firm*—Taylor J. Ross

[57] **CLAIM**

The ornamental design of an item retainer for modular serving stand, as shown.

**DESCRIPTION**

FIG. 1 is a top, front perspective view of an item retainer for modular serving stand showing the new design; FIG. 2 is a bottom front perspective view thereof; FIG. 3 is a front elevation view thereof; FIG. 4 is a rear elevation view thereof; FIG. 5 is a right side elevation view thereof; FIG. 6 is a left side elevation view thereof; FIG. 7 is a top plan view thereof; and, FIG. 8 is a bottom plan view thereof.

**1 Claim, 3 Drawing Sheets**

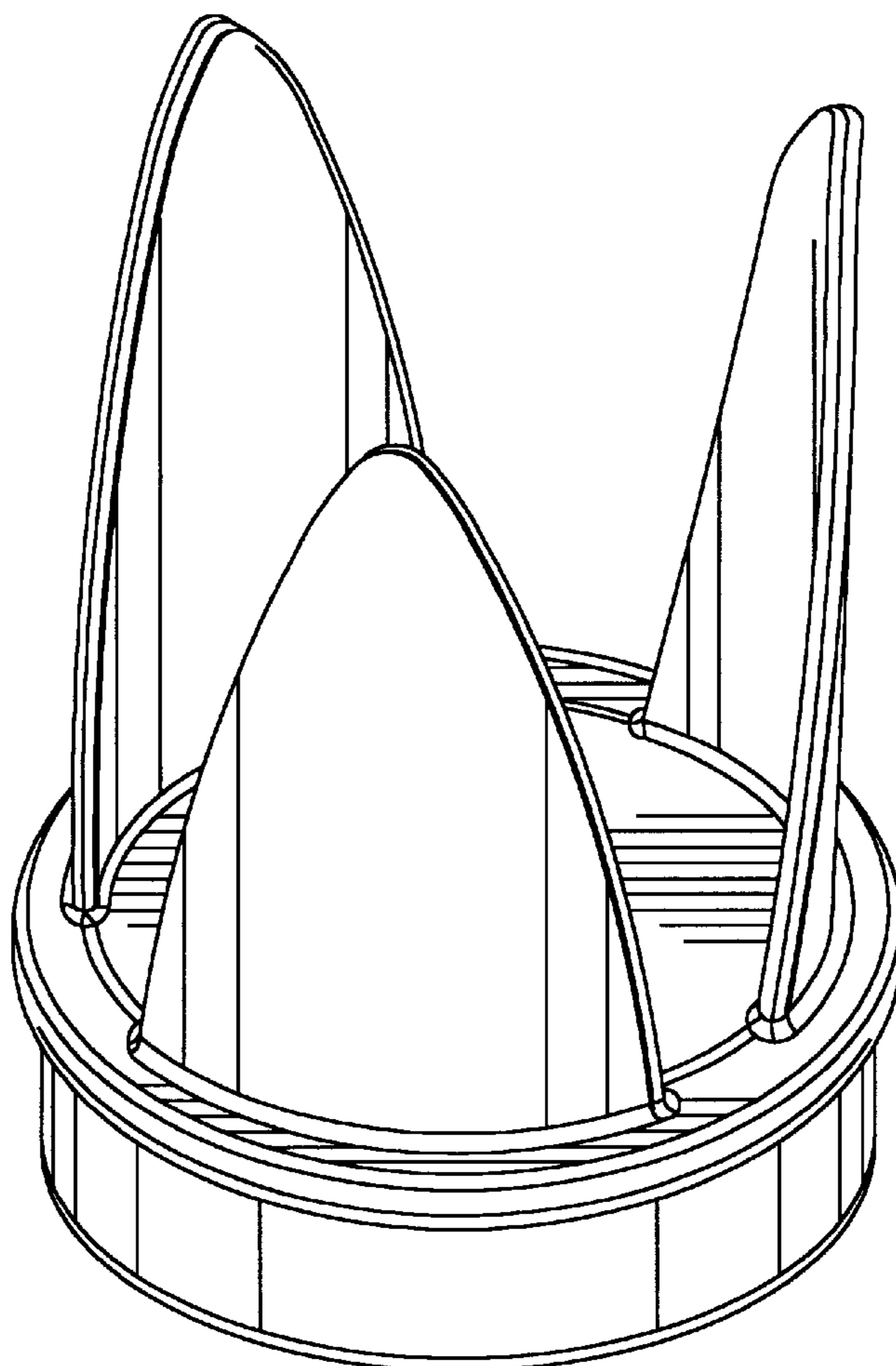

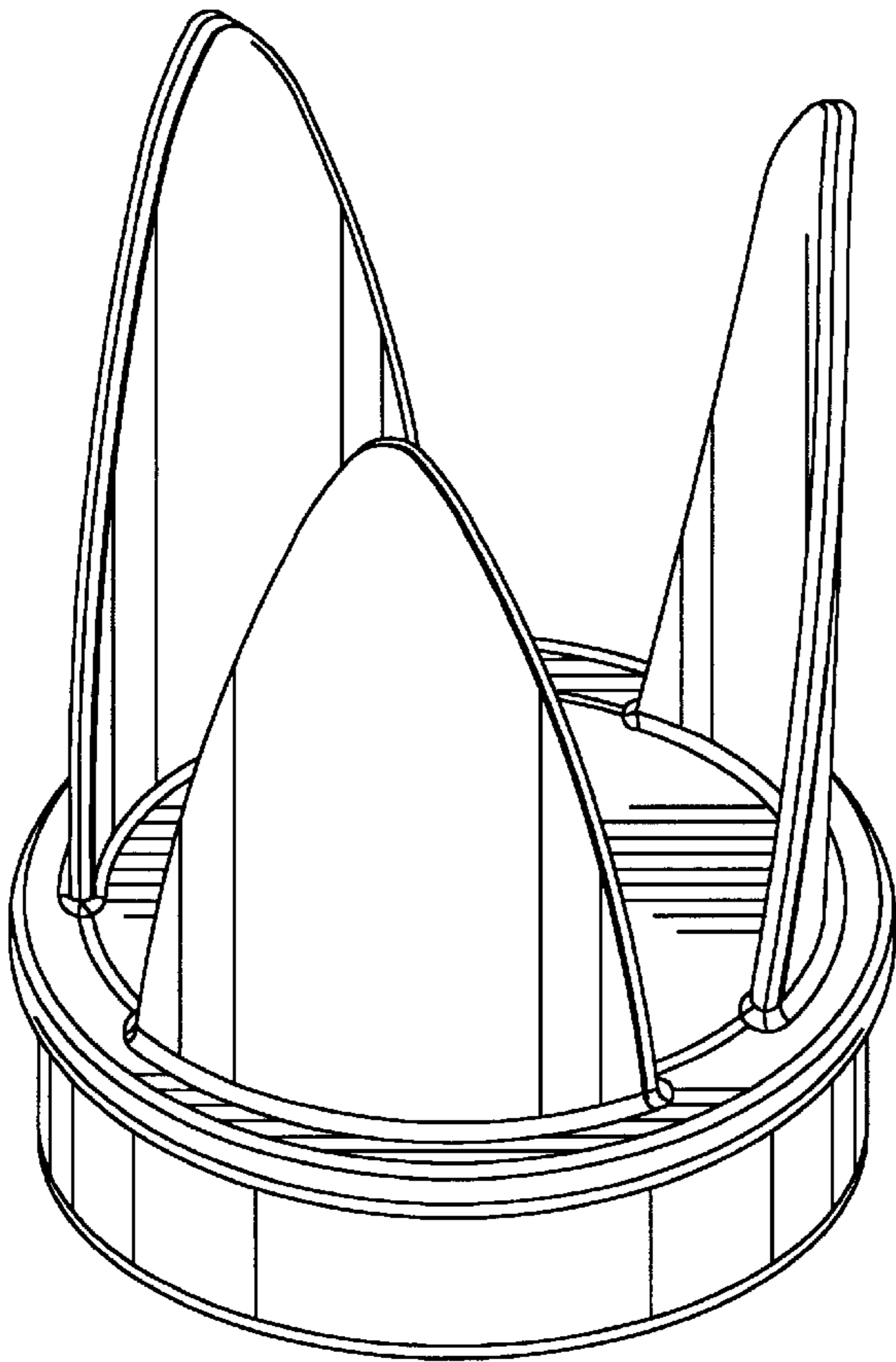

*FIG. 1*

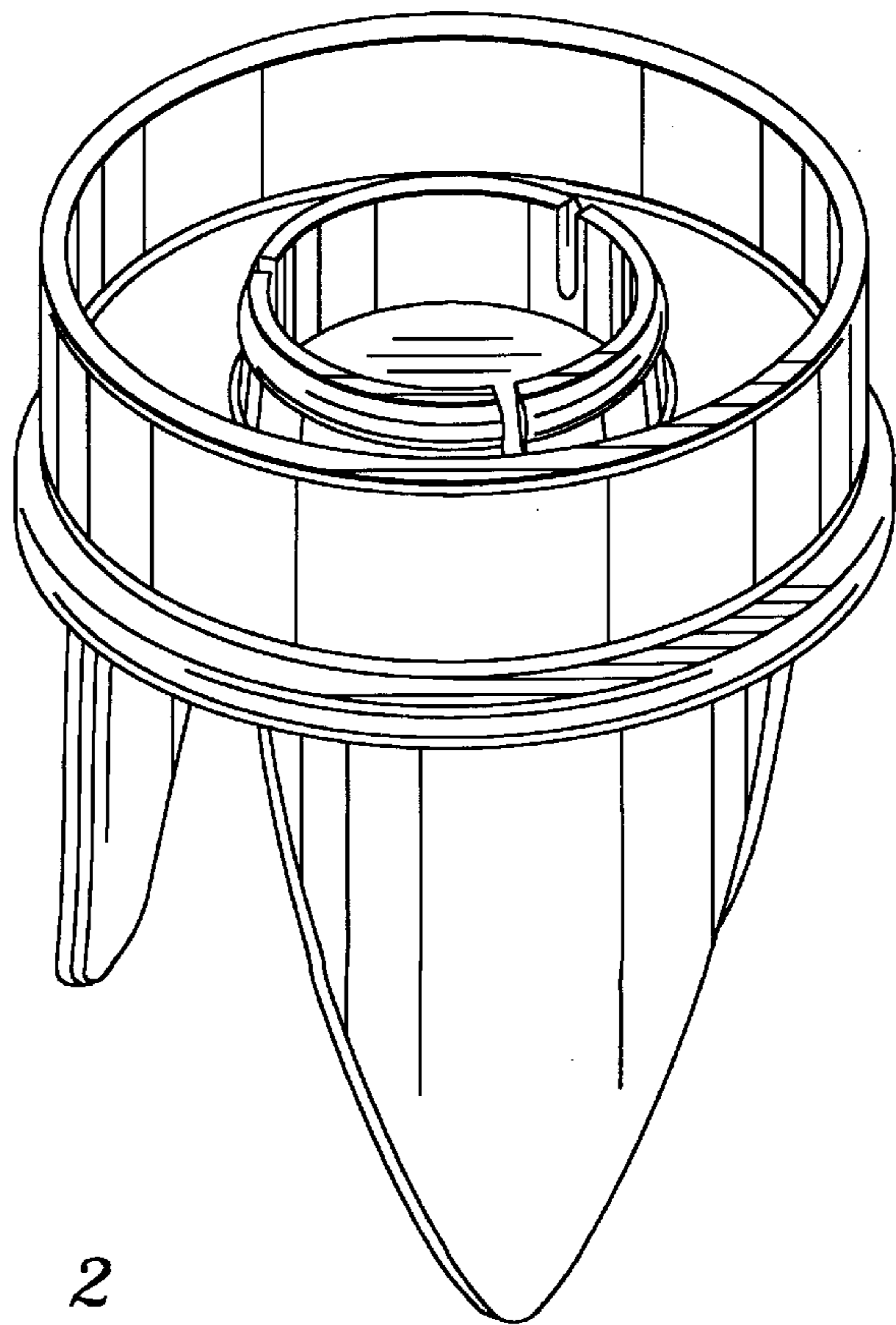

*FIG. 2*

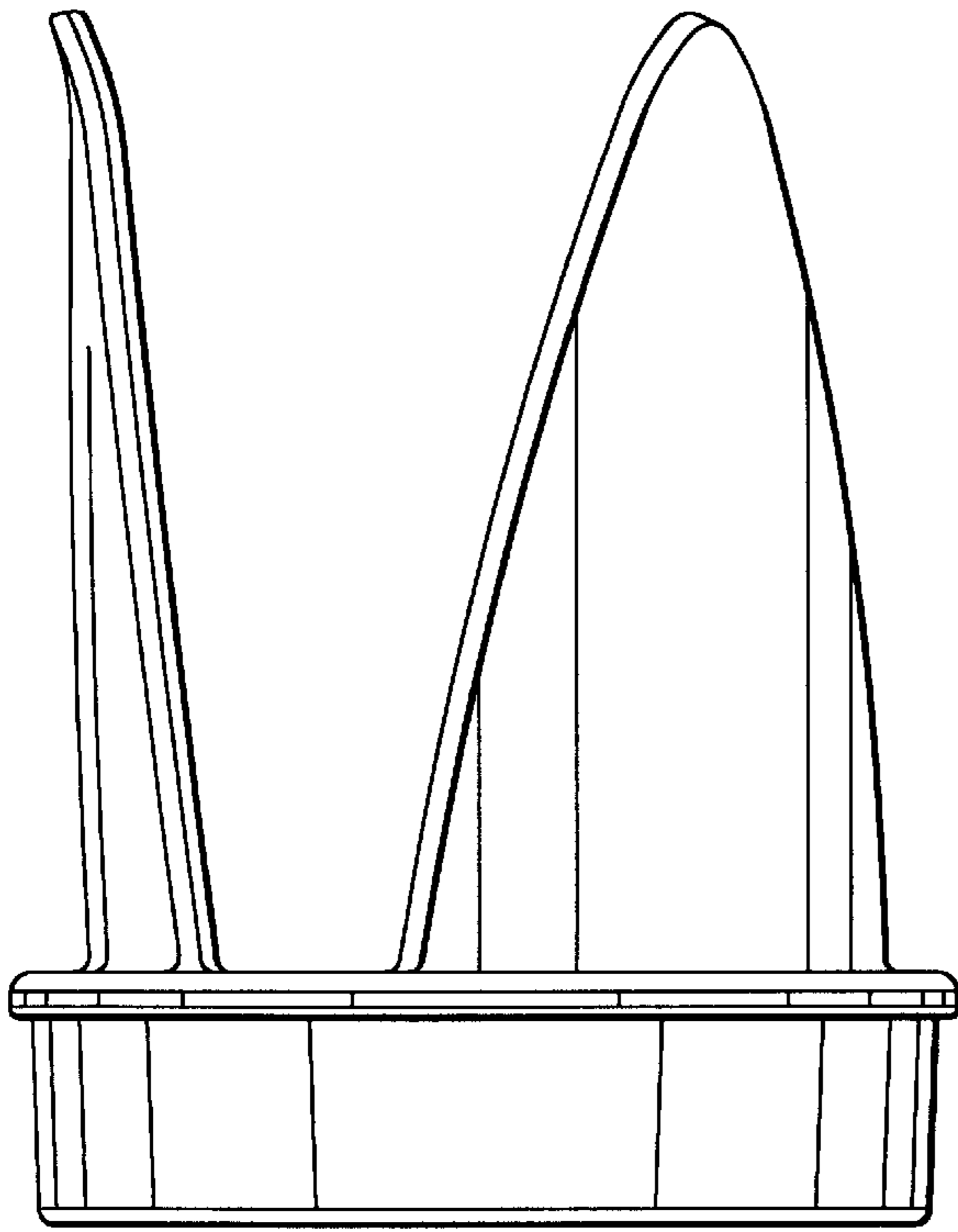

FIG. 3

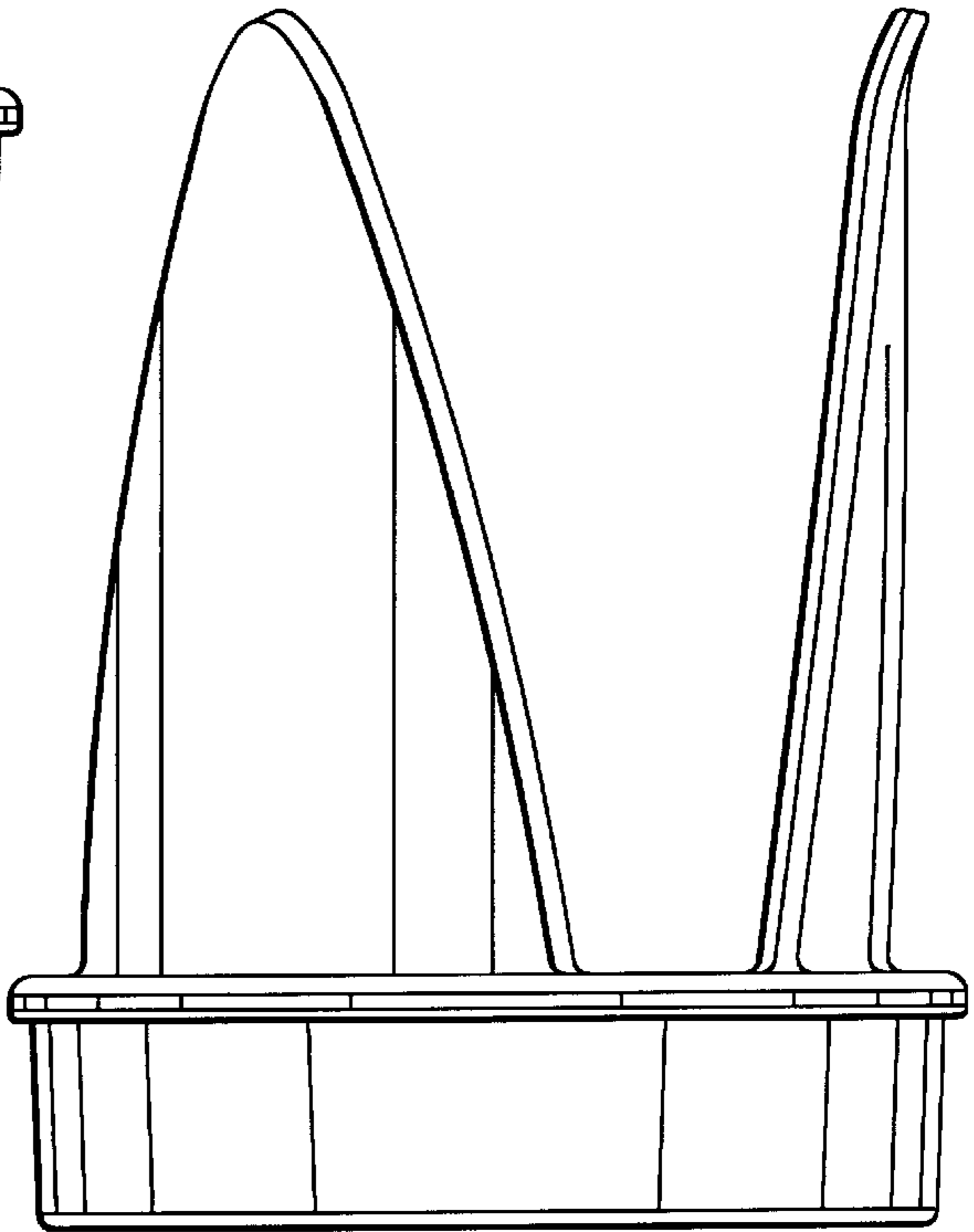

FIG. 4

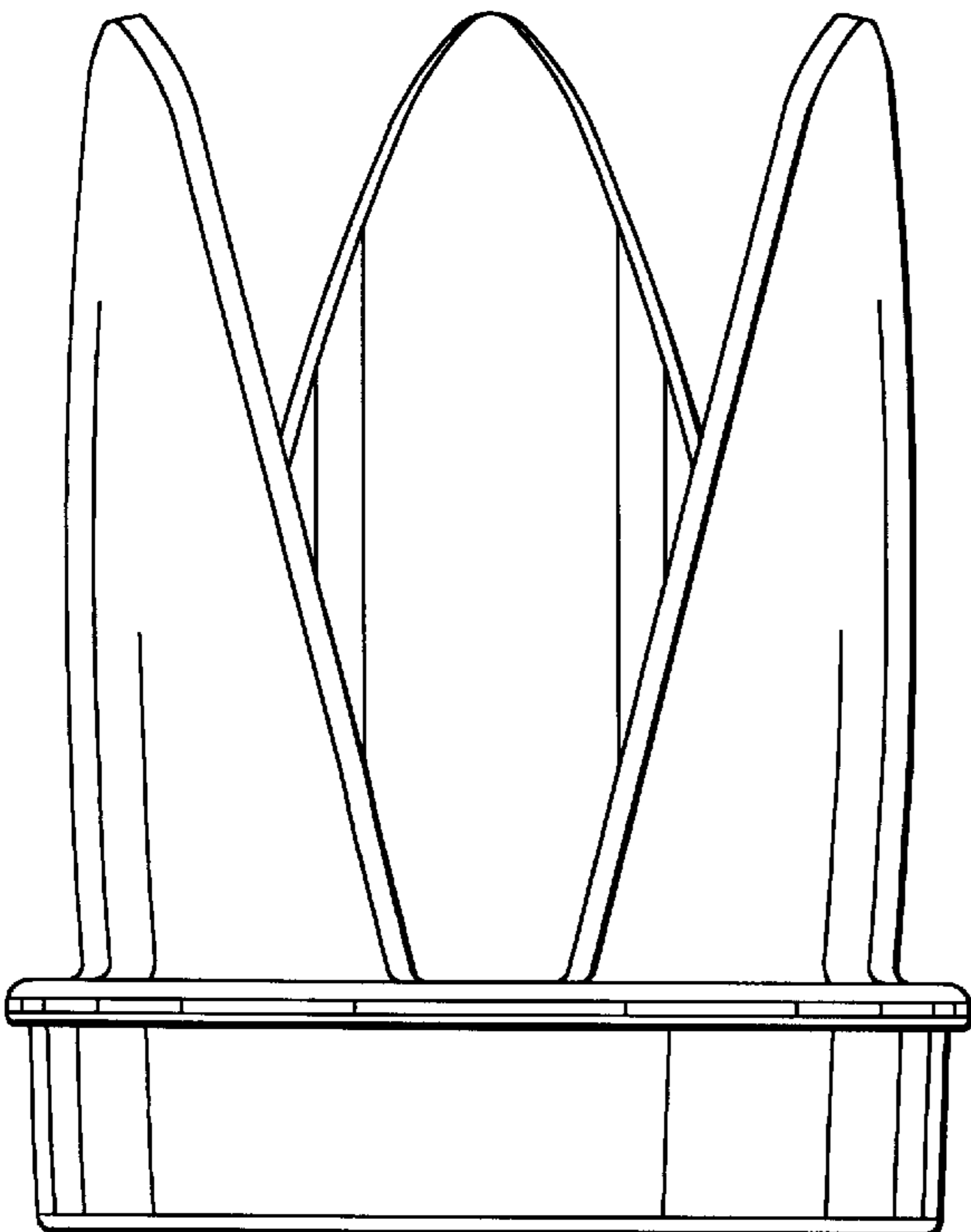

FIG. 5

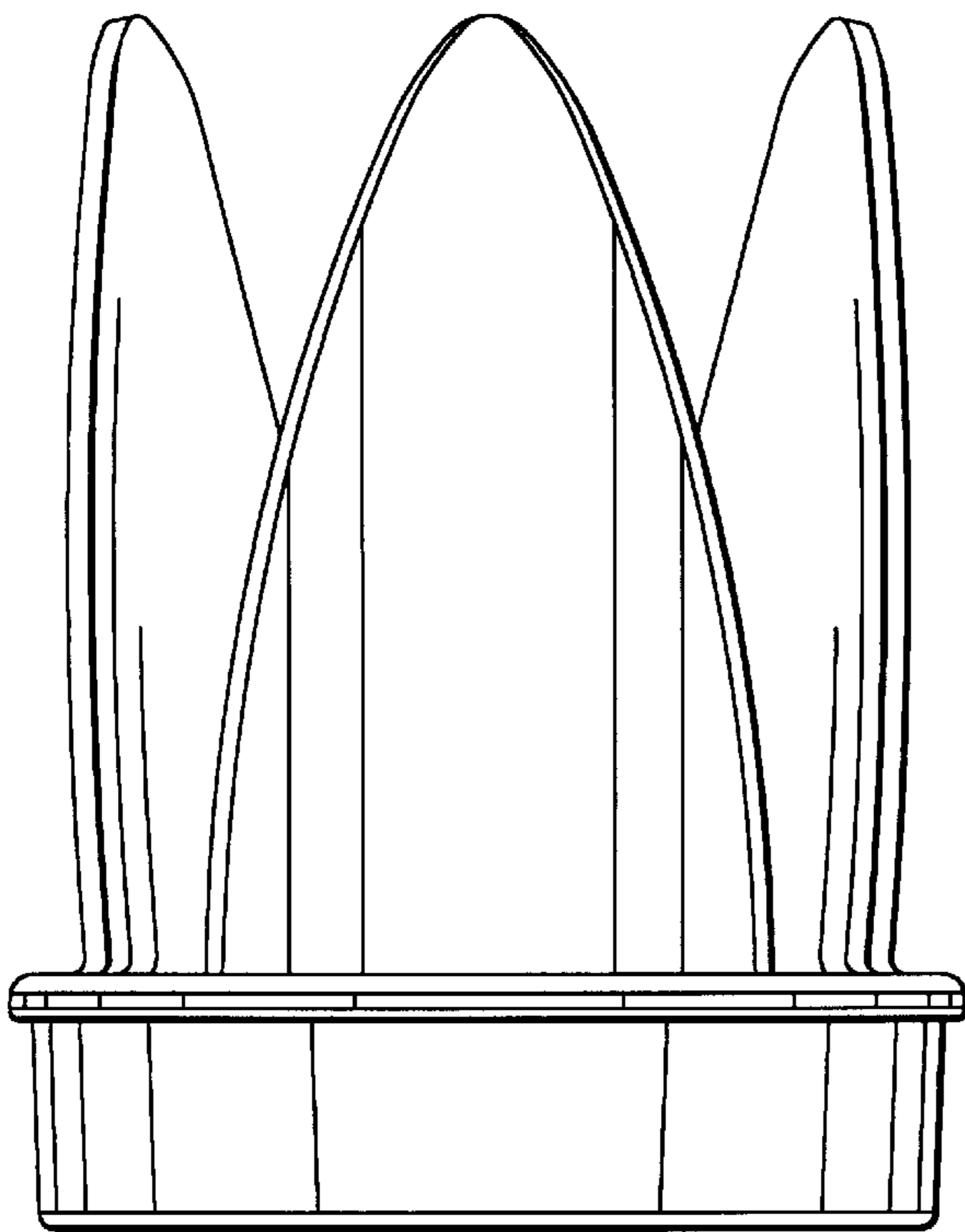

FIG. 6

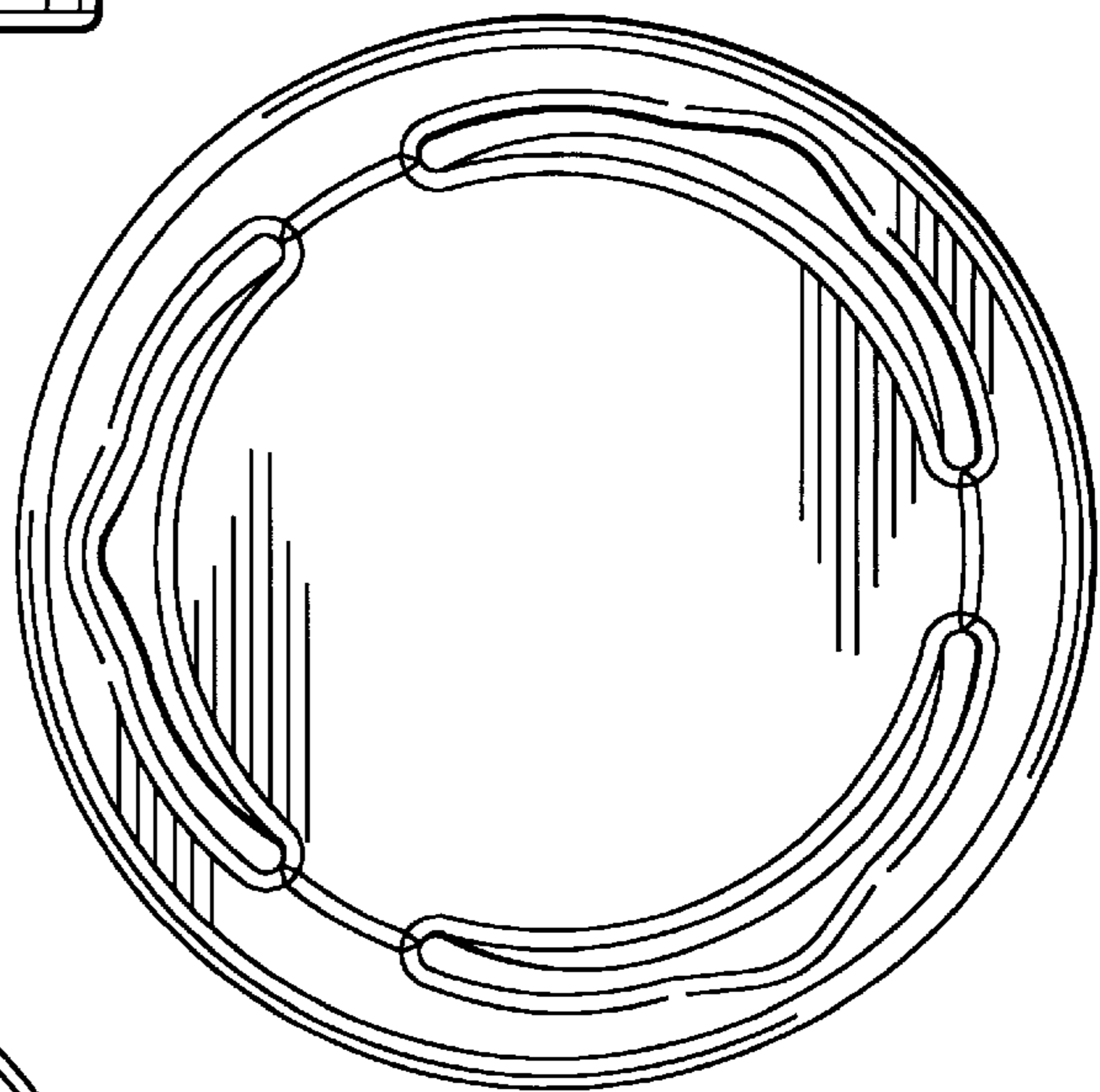

FIG. 7

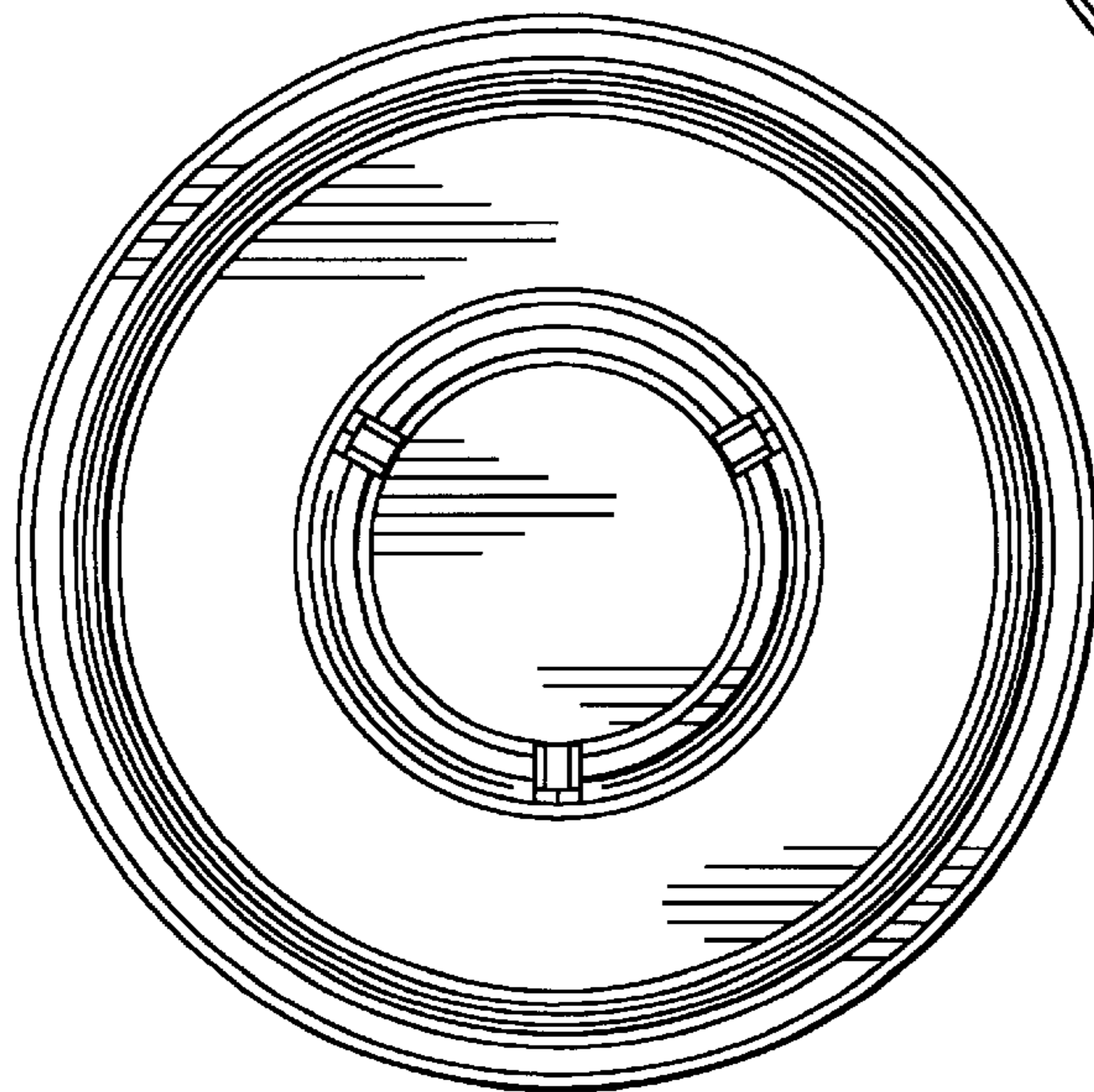

FIG. 8