



US00D428291S

United States Patent [19]

Koncar

[11] **Patent Number: Des. 428,291**

[45] **Date of Patent: ** Jul. 18, 2000**

[54] **ARCOS CONSOLE**

[76] Inventor: **John Florian Koncar**, 1737 Andrews Ct., Cleveland, Ohio 44118

[**] Term: **14 Years**

[21] Appl. No.: **29/103,205**

[22] Filed: **Apr. 9, 1999**

[51] **LOC (7) Cl. 08-08**

[52] **U.S. Cl. D6/574**

[58] **Field of Search** D6/553, 567, 574, D6/528, 531, 534, 535, 511; 211/13.1, 14, 34, 35, 63, 65-66, 70.5, 70.6, 70.7, 71, 74-75, 86-90, 126, 134; 108/42, 149

[56] **References Cited**

U.S. PATENT DOCUMENTS

- D. 201,023 5/1965 Sonneveldt D6/574
- D. 332,718 1/1993 Wolfe, III D6/574
- D. 352,198 11/1994 Wright et al. D6/574

- D. 373,699 9/1996 Moon D6/574
- D. 392,828 3/1998 Lauer D6/574
- D. 403,546 1/1999 Moon D6/574
- 1,243,059 10/1917 Friesleben 211/134 X
- 2,911,108 11/1959 Nield 211/13.1 X

Primary Examiner—Brian N. Vinson

[57] **CLAIM**

The ornamental design for a arcos console, as shown and described.

DESCRIPTION

FIG. 1 is a perspective view of the arcos console of the invention;
 FIG. 2 is a front view of the arcos console of the invention;
 FIG. 3 is a rear view of the arcos console of the invention;
 FIG. 4 is a top view of the arcos console of the invention;
 FIG. 5 is a bottom view of the arcos console of the invention;
 FIG. 6 is a side view of the arcos console of the invention;
 and,
 FIG. 7 is a side view of the arcos console of the invention.

1 Claim, 1 Drawing Sheet

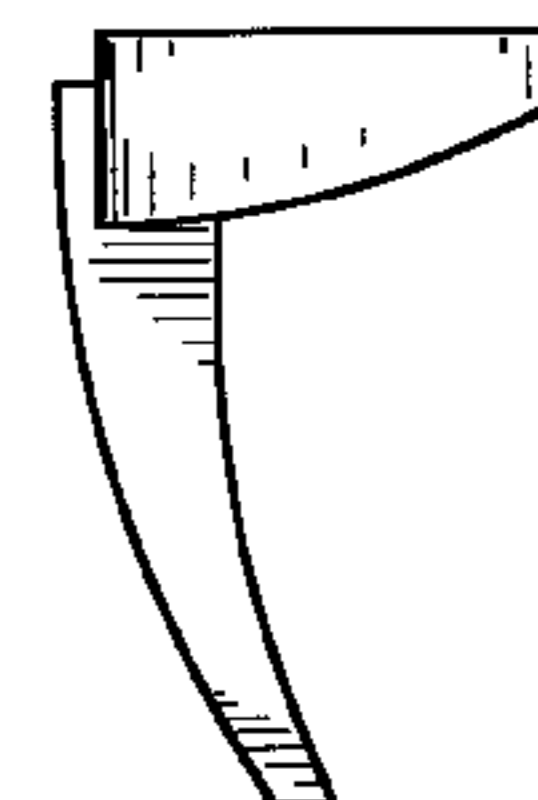
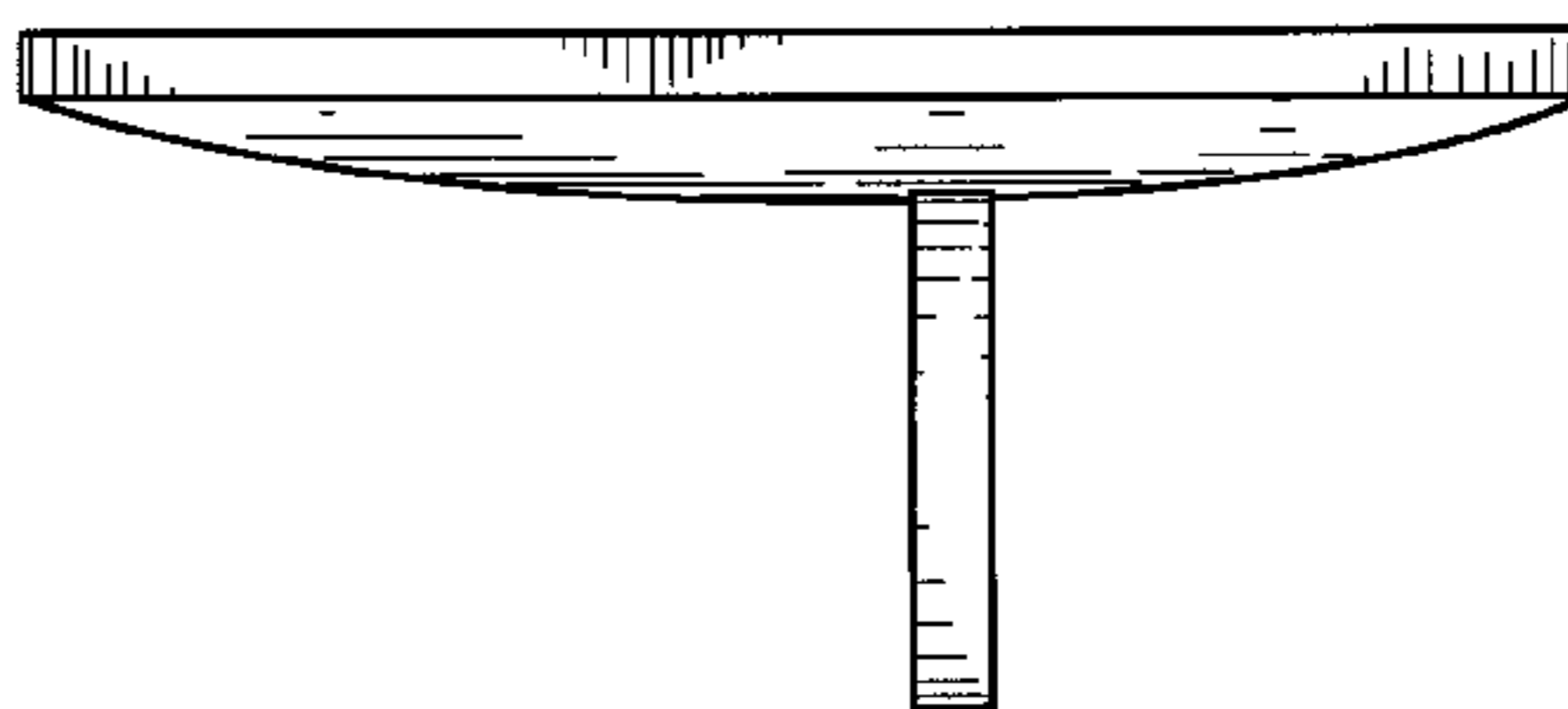
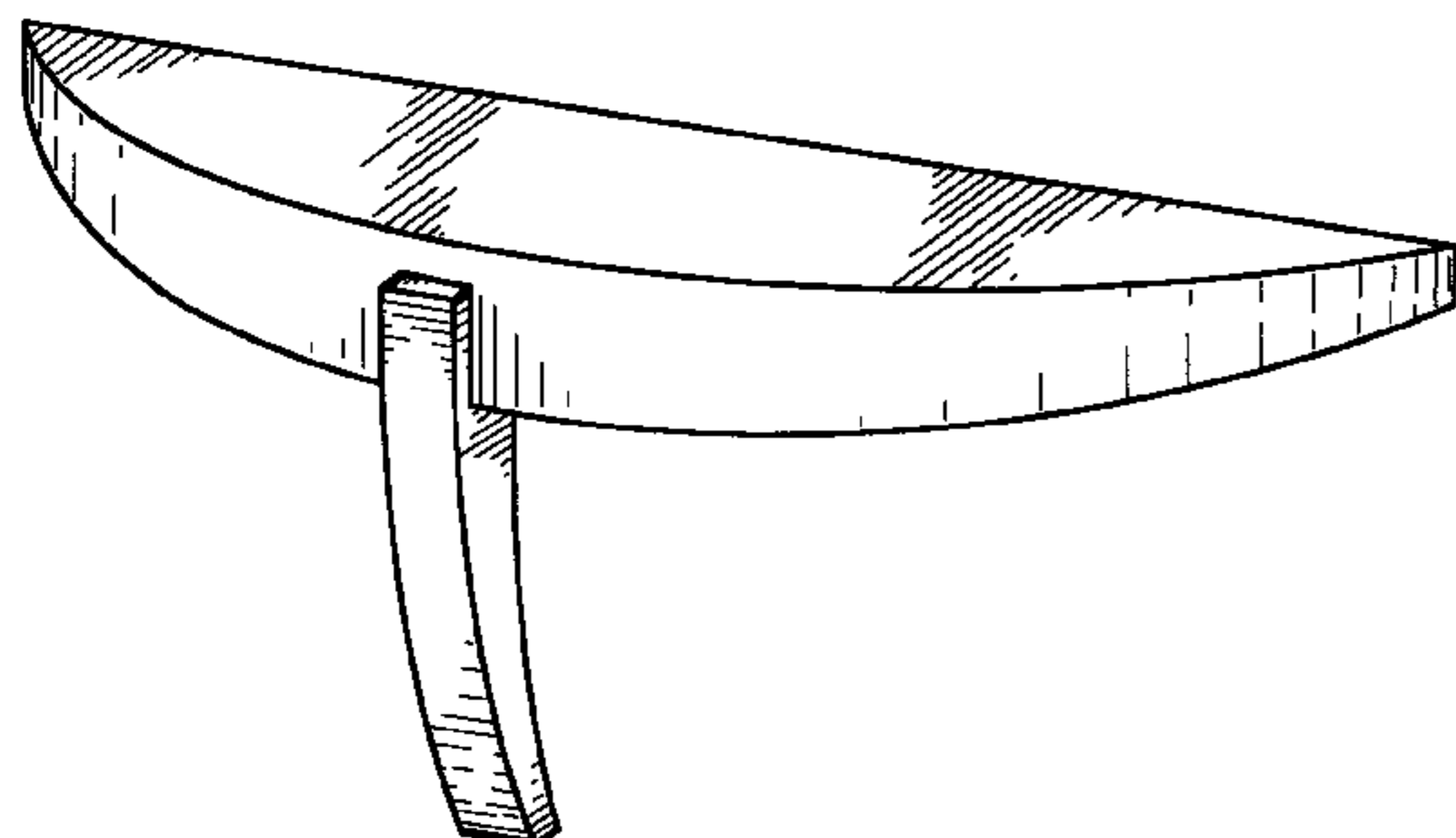

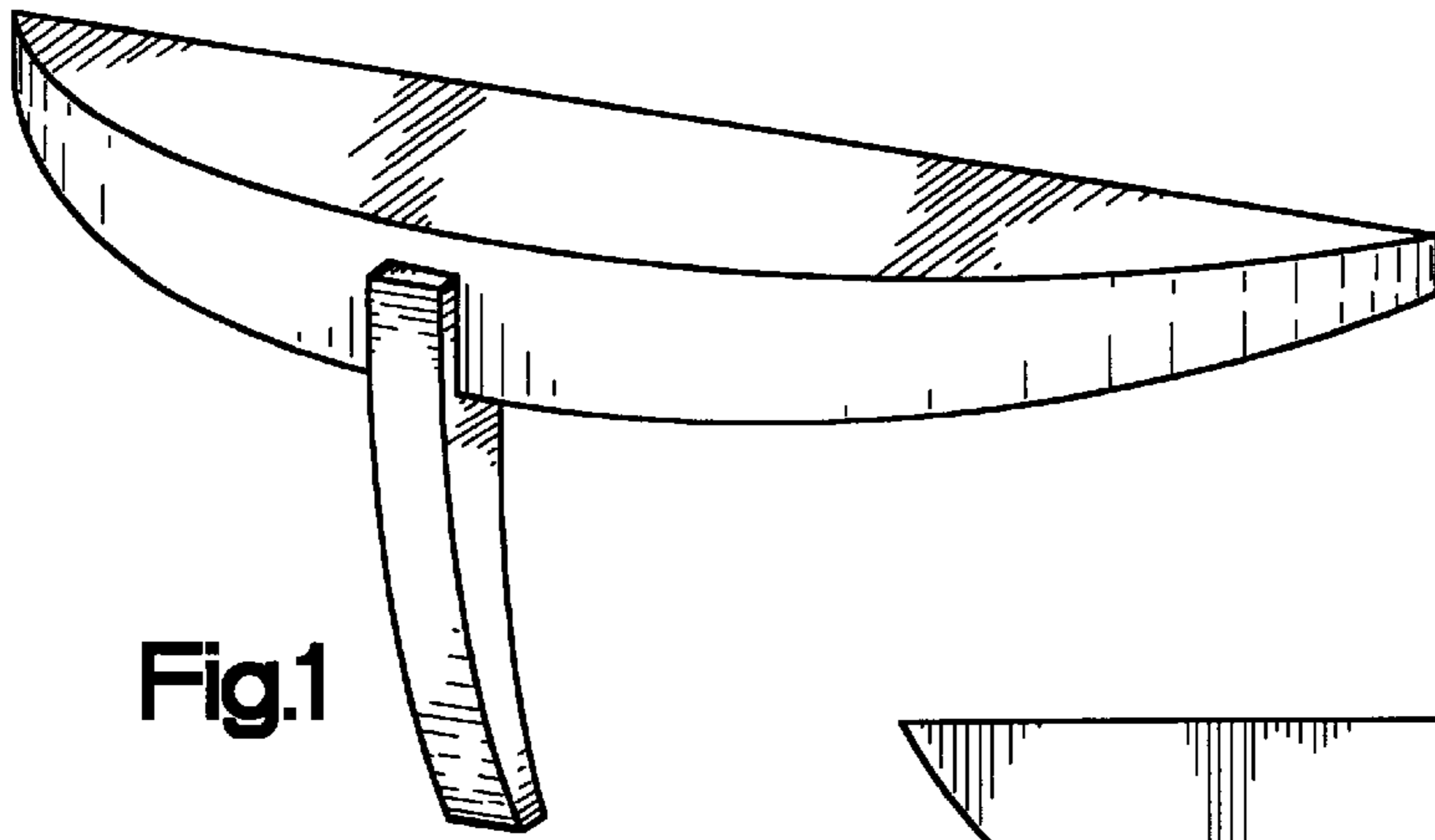

Fig.1

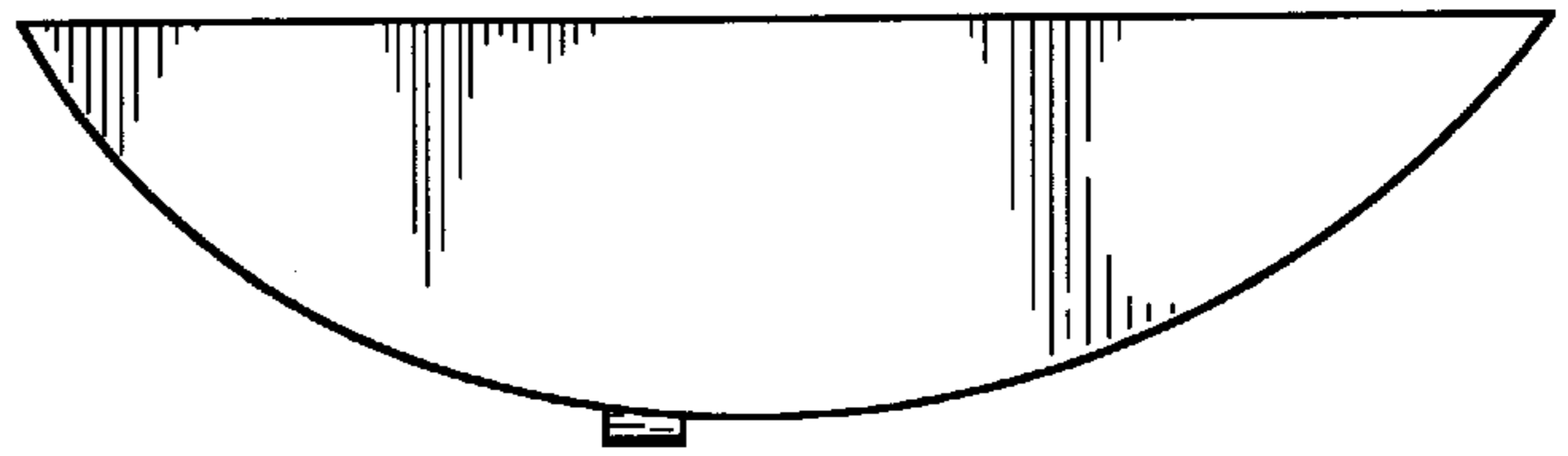

Fig.4

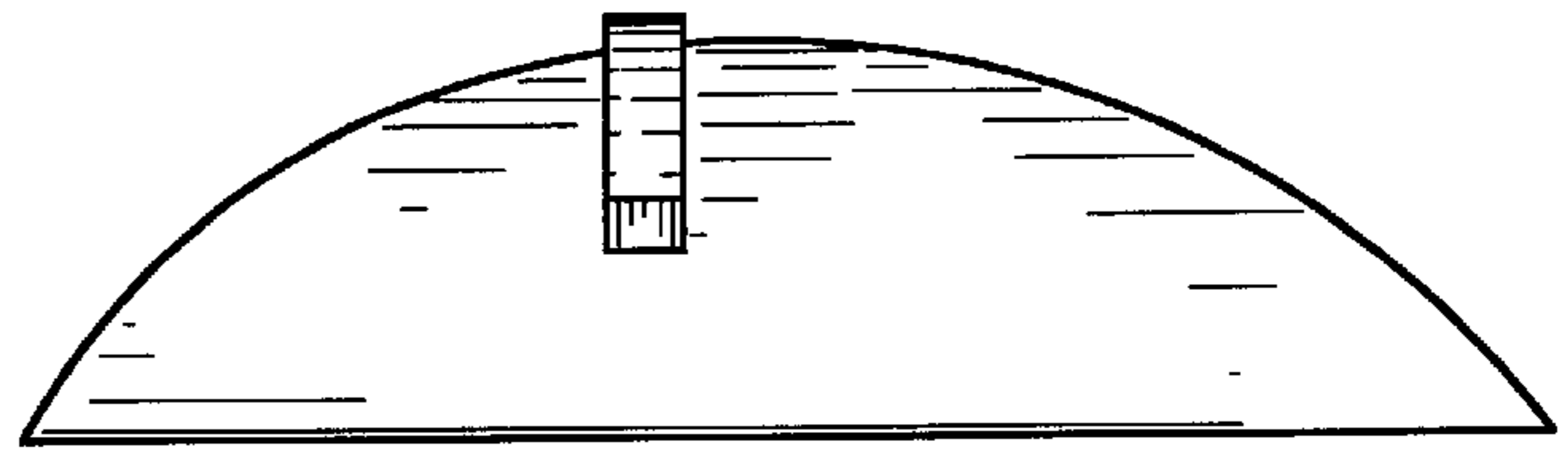

Fig.5

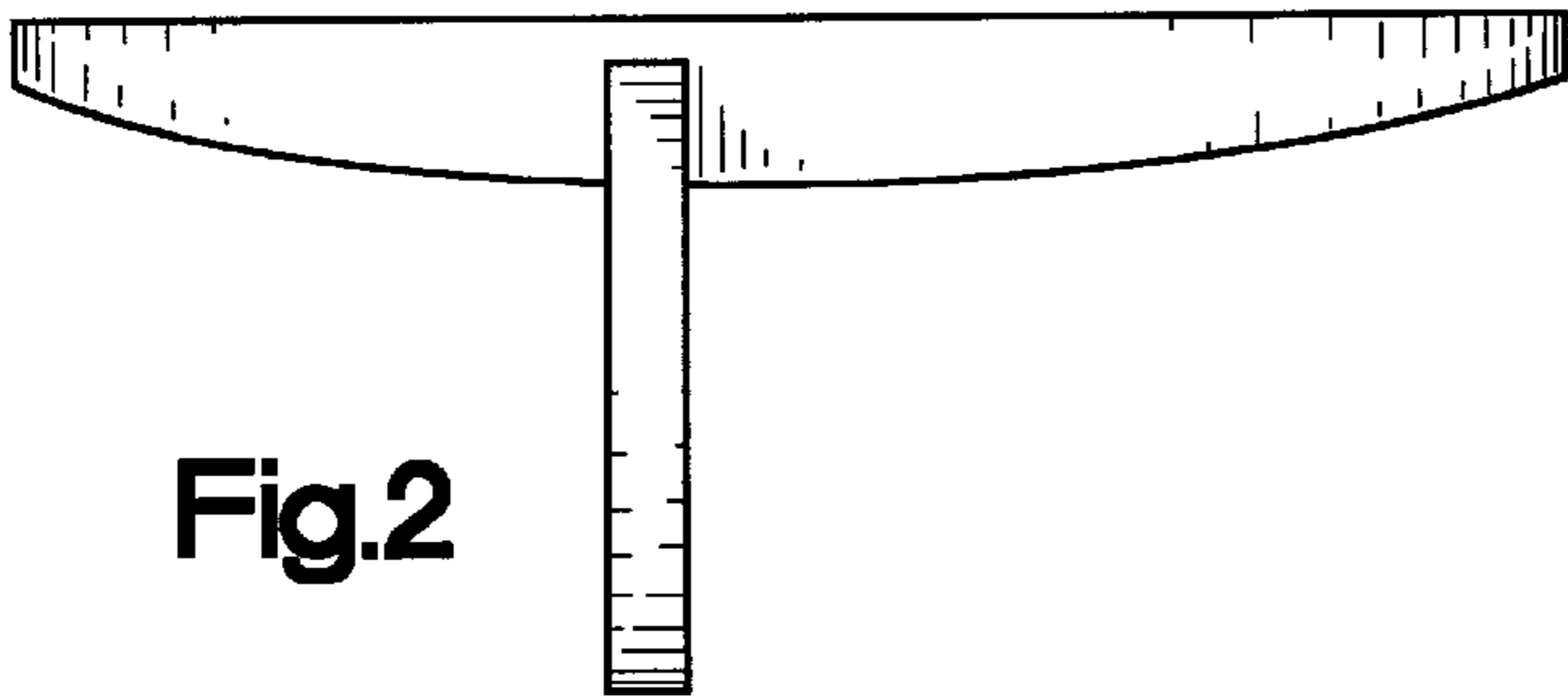

Fig.2

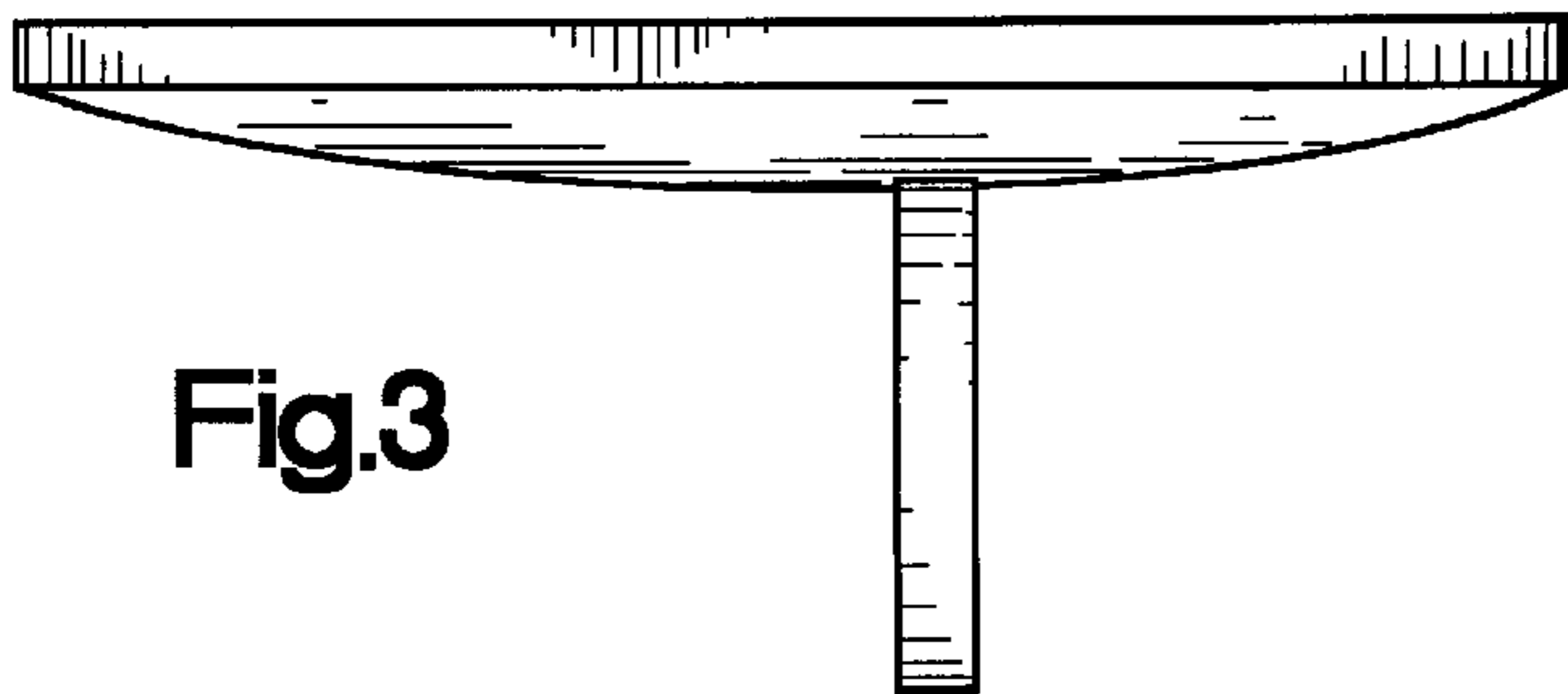

Fig.3

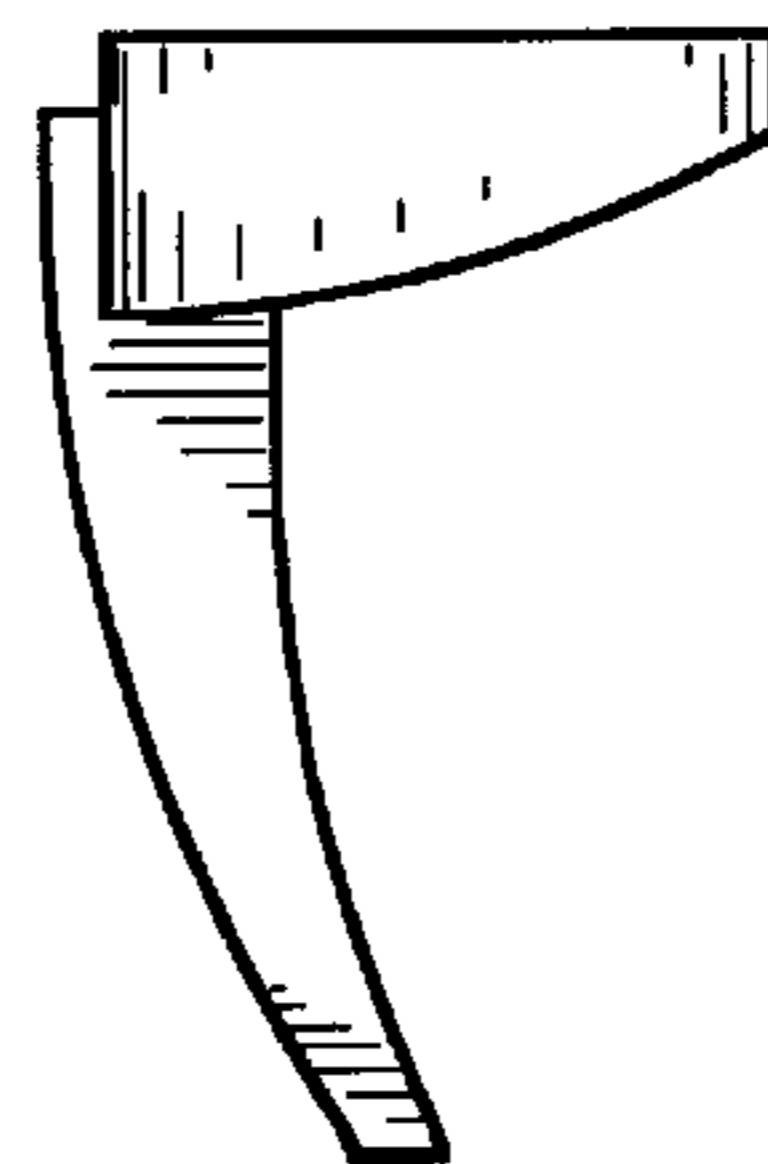

Fig.6

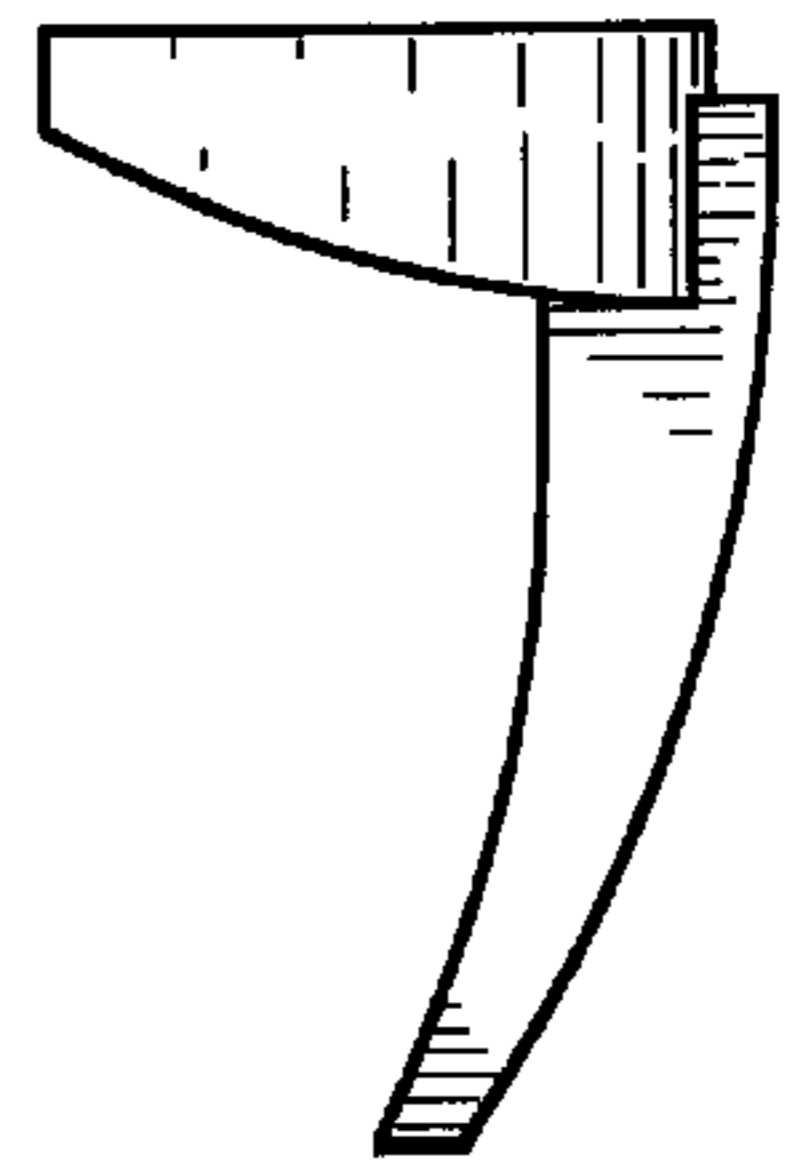

Fig.7