



US00D428051S

United States Patent [19] Ikenaga

[11] **Patent Number: Des. 428,051**

[45] **Date of Patent: ** Jul. 11, 2000**

[54] **VIDEO PRINTER**

[75] Inventor: **Takashi Ikenaga**, Tokyo, Japan

[73] Assignee: **Sony Corporation**, Japan

[**] Term: **14 Years**

[21] Appl. No.: **29/088,269**

[22] Filed: **May 18, 1998**

[30] **Foreign Application Priority Data**

Nov. 18, 1997 [JP] Japan 9-75446

[51] **LOC (7) Cl.** **14-02**

[52] **U.S. Cl.** **D18/50**

[58] **Field of Search** D18/50, 54-55,
D18/36, 37, 39; 400/613, 613.1-613.4,
690.1-690.4, 691-694

[56] **References Cited**

U.S. PATENT DOCUMENTS

D. 320,616	10/1991	Takahashi	D18/55
D. 322,091	12/1991	Tokuda	D18/54
D. 334,022	3/1993	Byun	D18/50
D. 334,402	3/1993	Matsumoto et al.	D18/50
D. 369,826	5/1996	Ichiyoshi	D18/50
D. 374,031	9/1996	Ikenaga	D18/50
D. 381,678	7/1997	Nakamura	D18/50

OTHER PUBLICATIONS

Sony "UP-5500" brochure, (May 1997).

Primary Examiner—Cathy Anne MacCormac
Attorney, Agent, or Firm—Rader, Fishman & Grauer

[57] **CLAIM**

The ornamental design for a video printer, as shown and described.

DESCRIPTION

FIG. 1 is a perspective view of a first embodiment of a video printer showing my new design;
 FIG. 2 is a top plan view thereof;
 FIG. 3 is a left side elevational view thereof;
 FIG. 4 is a front elevational view thereof;
 FIG. 5 is a bottom plan view thereof;
 FIG. 6 is a right side elevational view thereof; and
 FIG. 7 is a rear elevational view thereof.
 FIG. 8 is a perspective view of a second embodiment of a video printer showing my new design;
 FIG. 9 is a top plan view of FIG. 8;
 FIG. 10 is a left side elevational view of FIG. 8;
 FIG. 11 is a front elevational view of FIG. 8;
 FIG. 12 is a bottom plan view of FIG. 8;
 FIG. 13 is a right side elevational view of FIG. 8; and,
 FIG. 14 is a rear elevational view of FIG. 8.

1 Claim, 6 Drawing Sheets

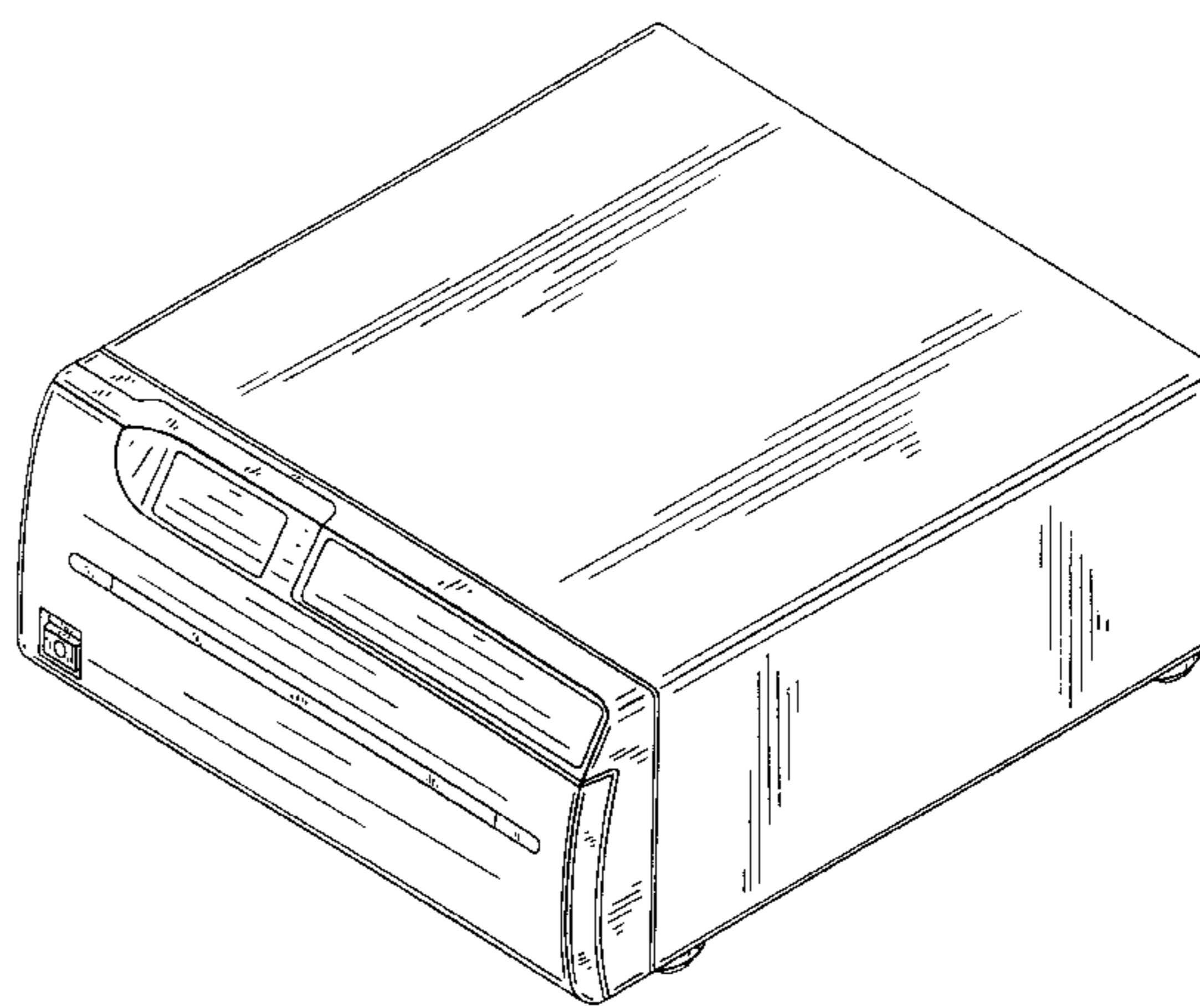
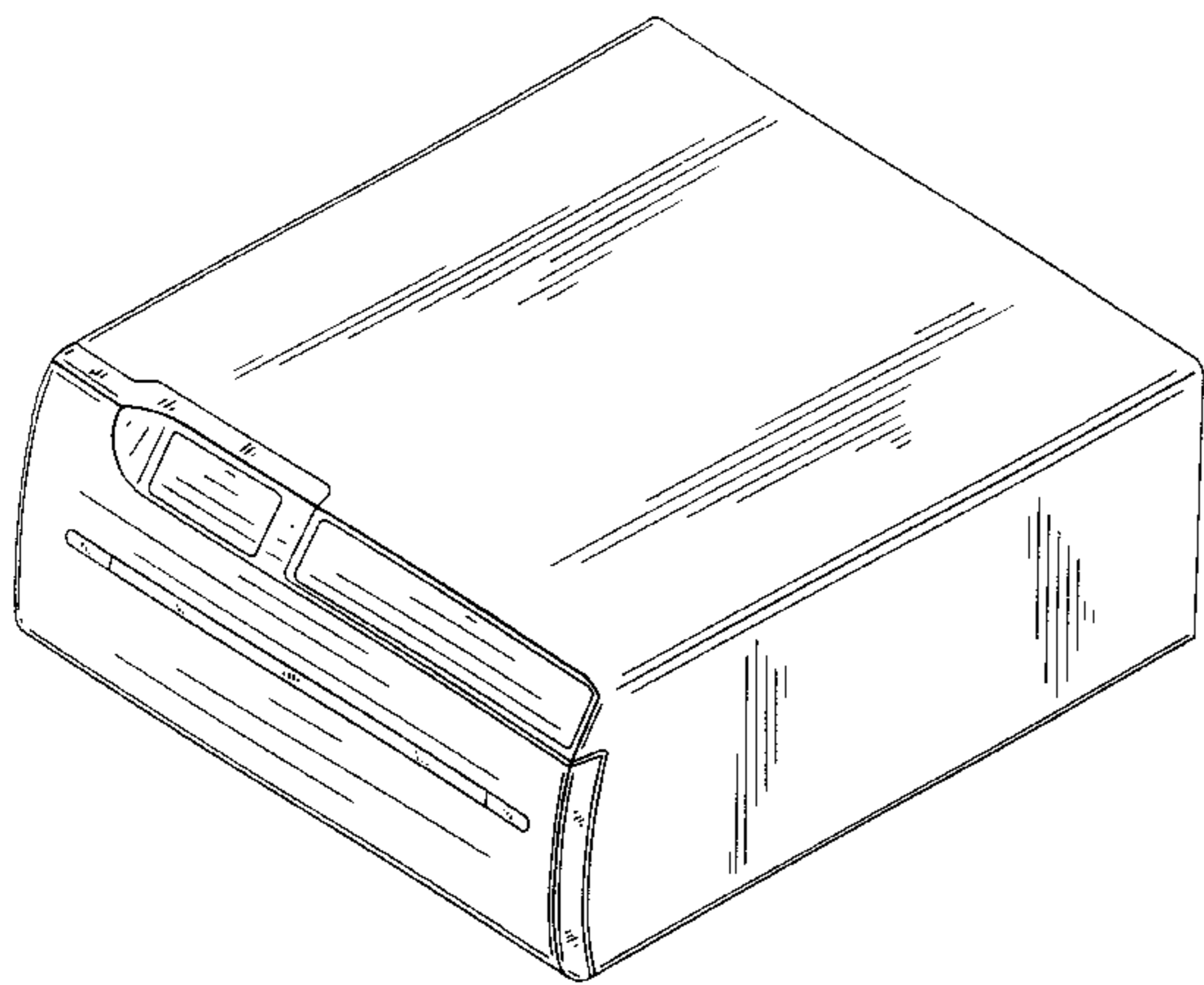

FIG. 1

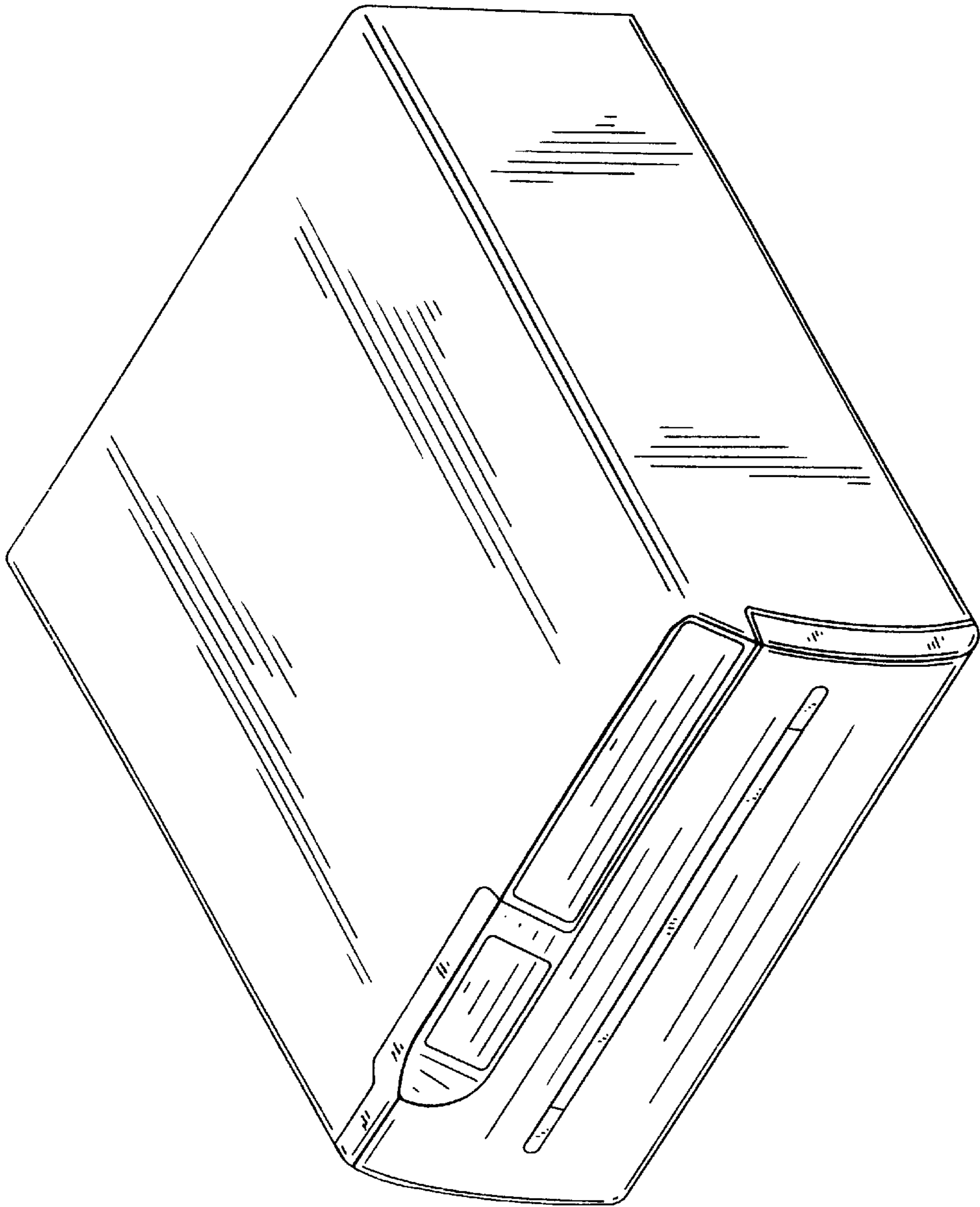

FIG. 2

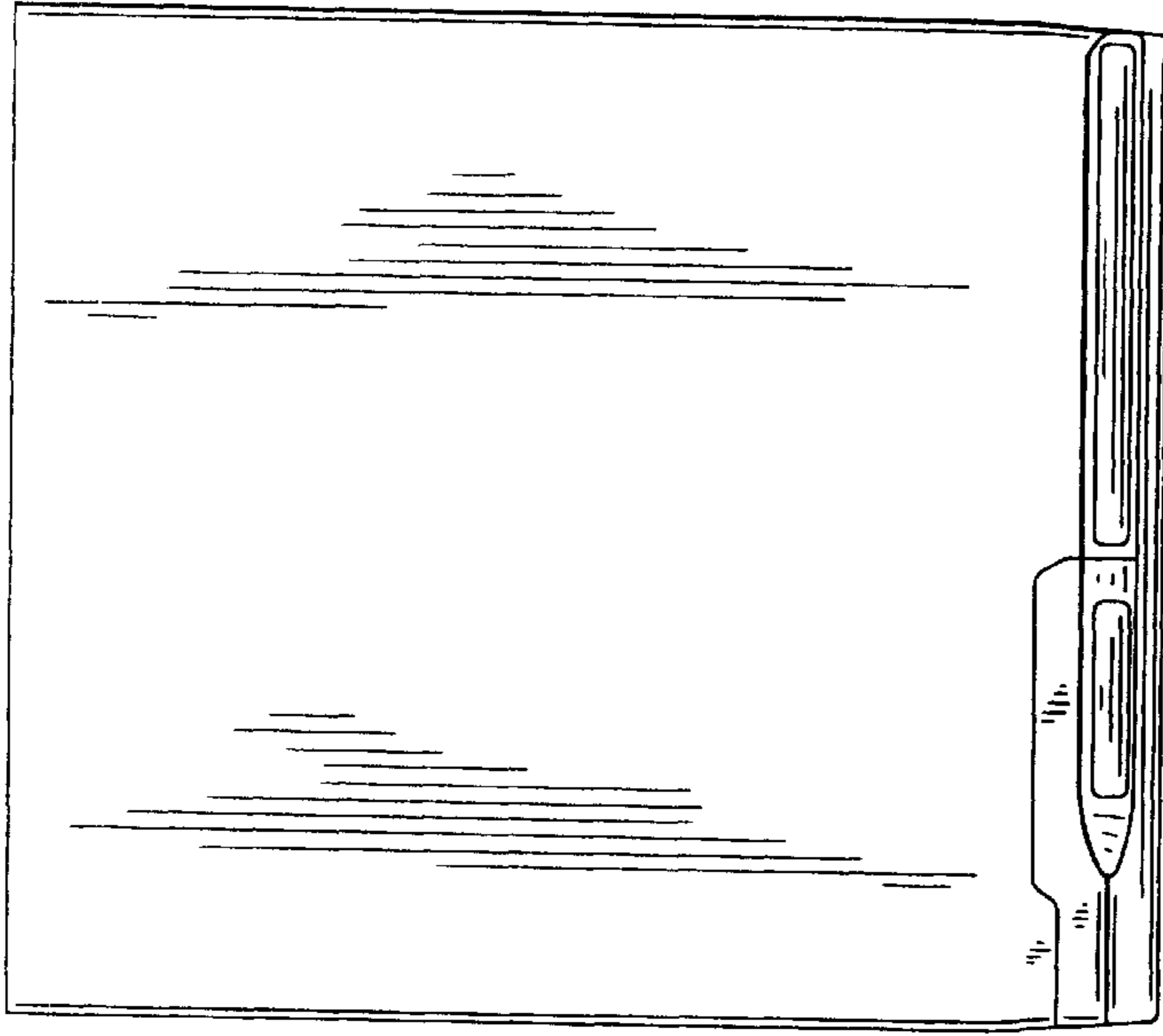

FIG. 4

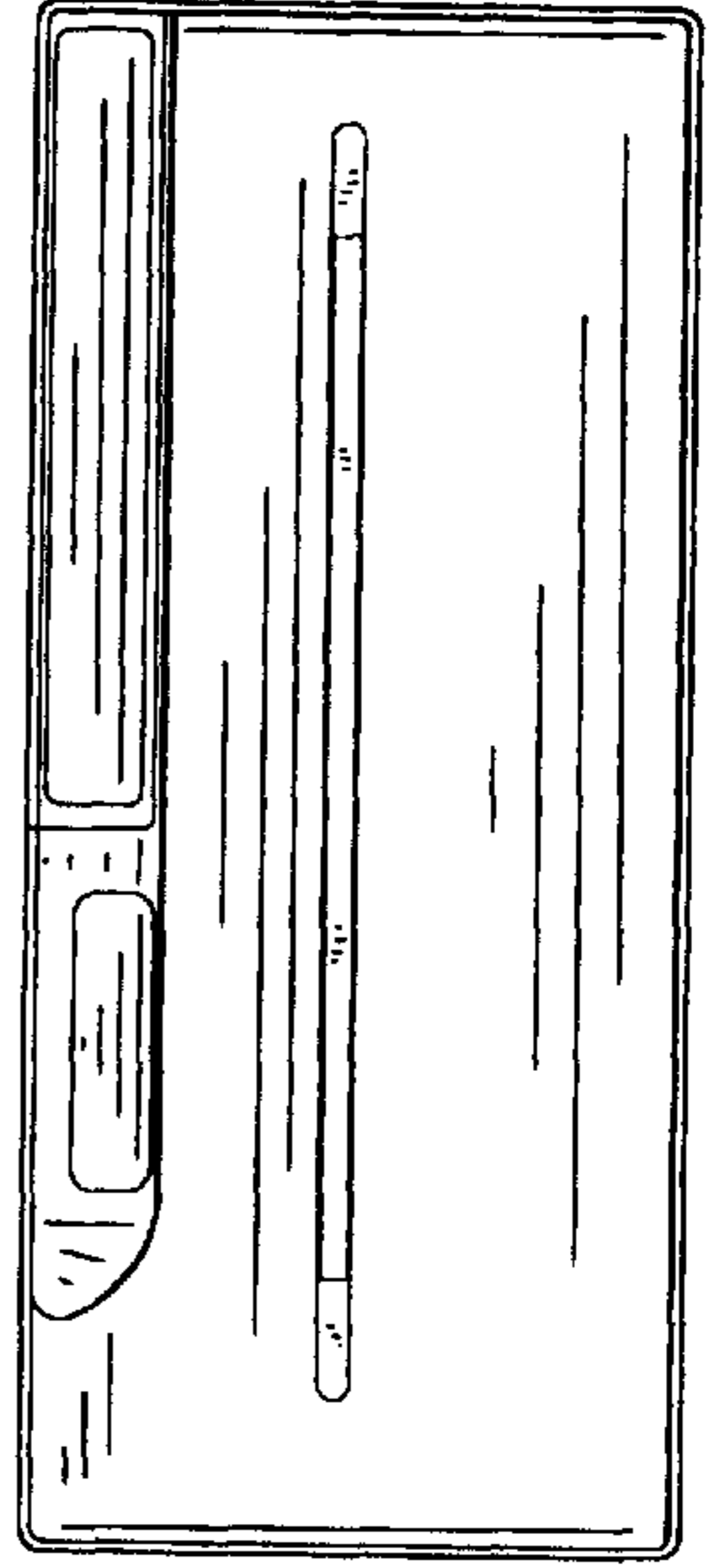

FIG. 3

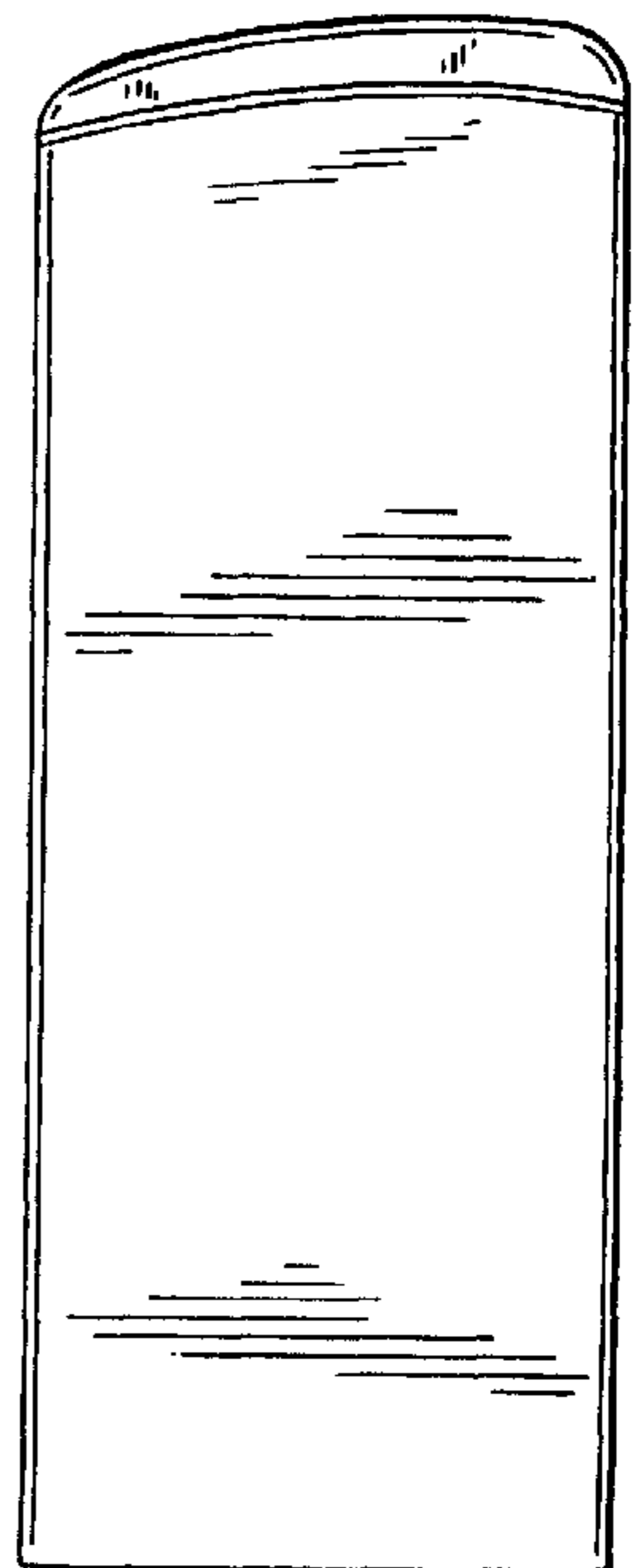

FIG. 7

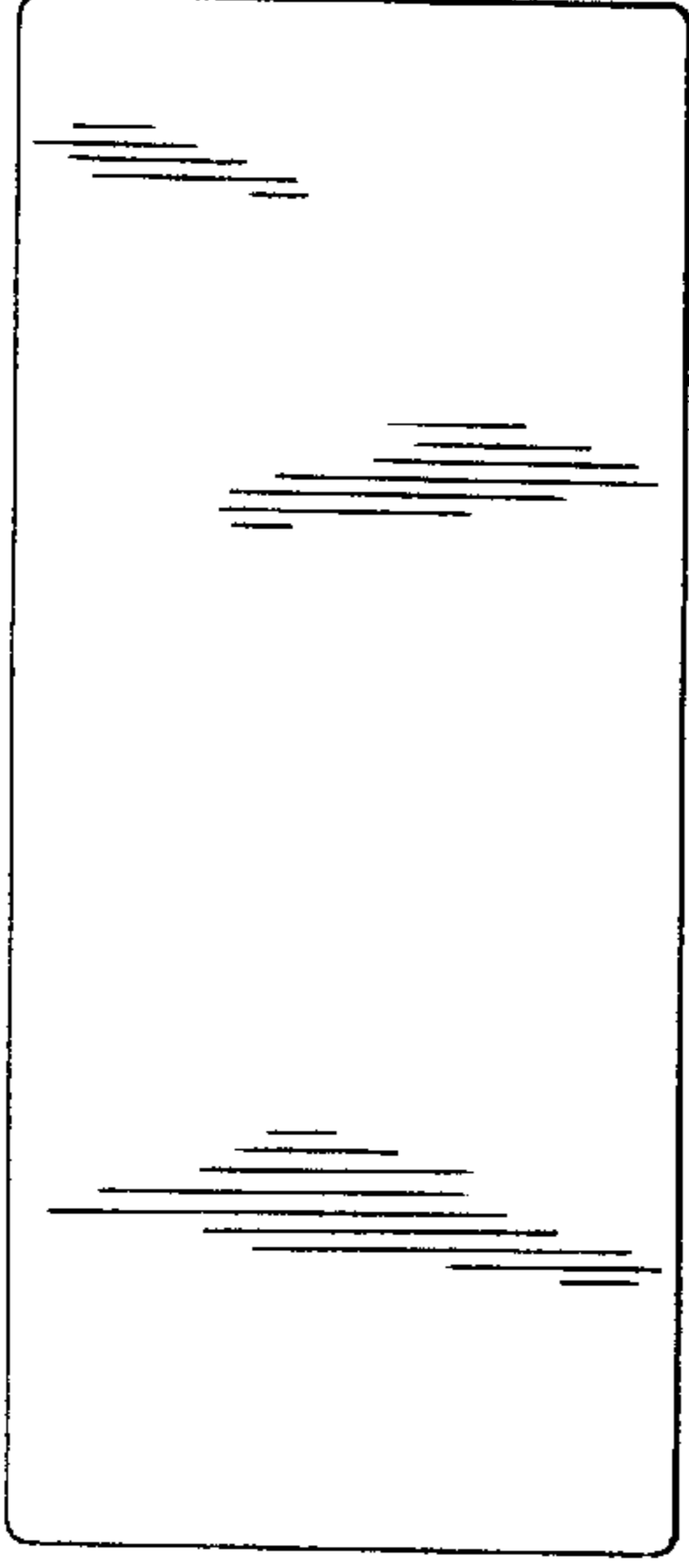

FIG. 5

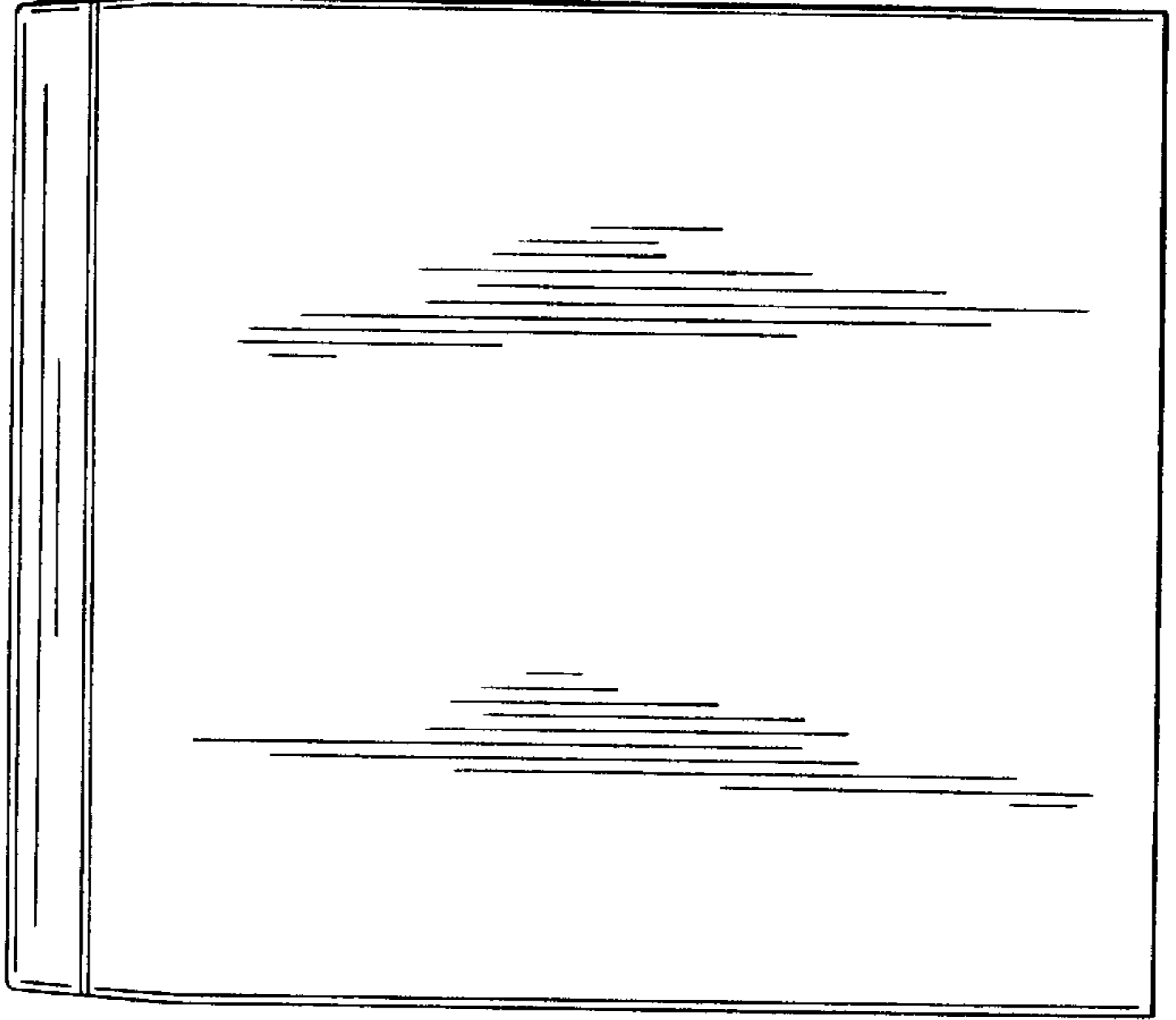

FIG. 6

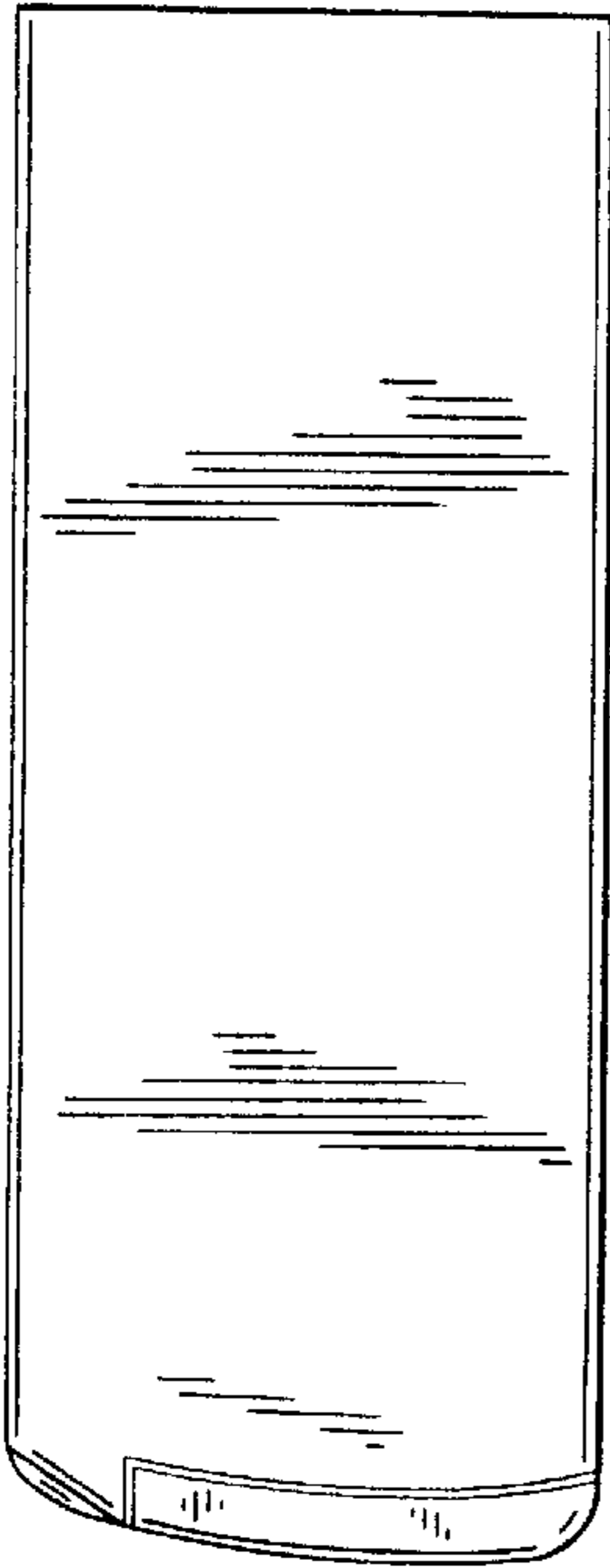

FIG. 8

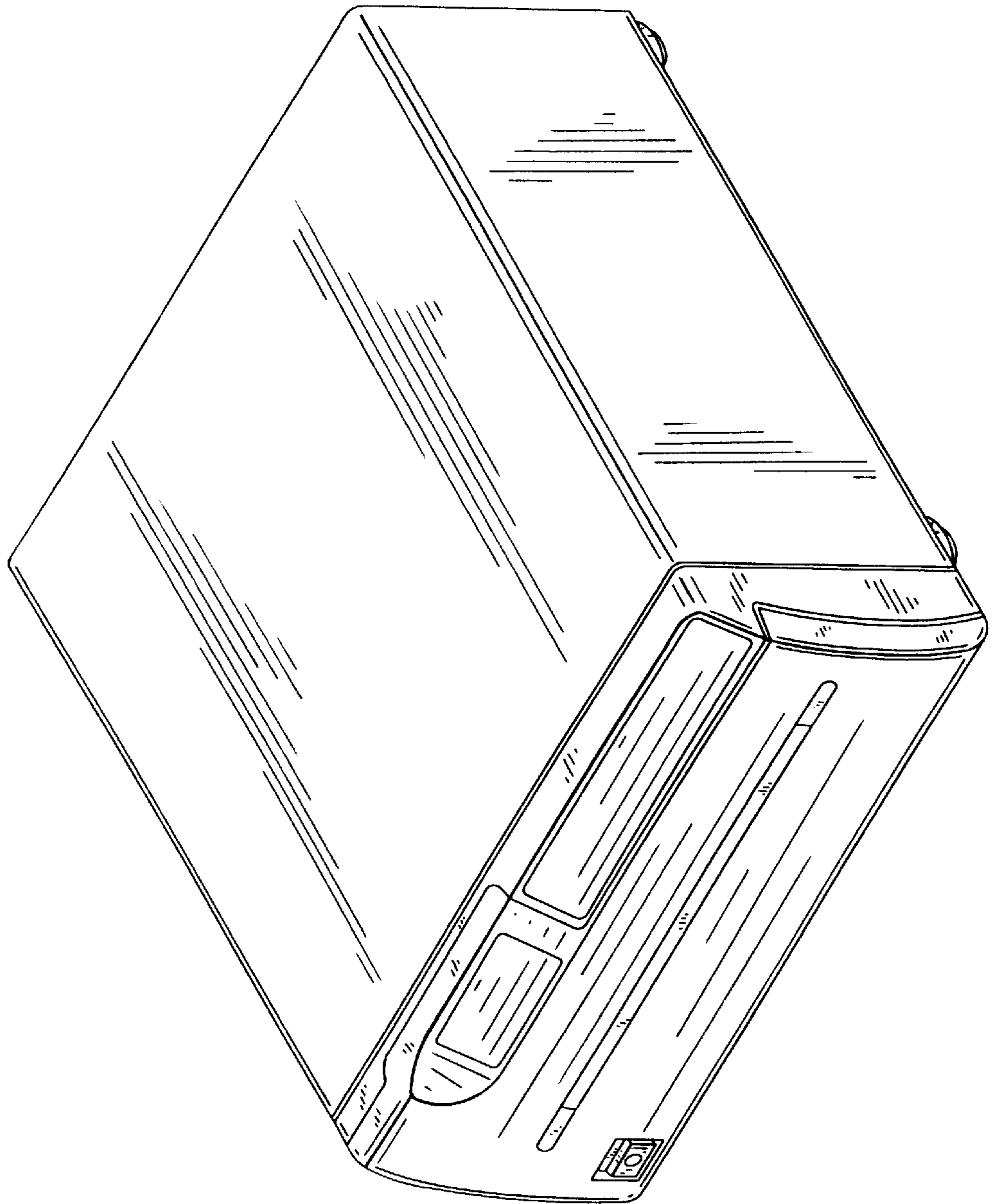

FIG. 9

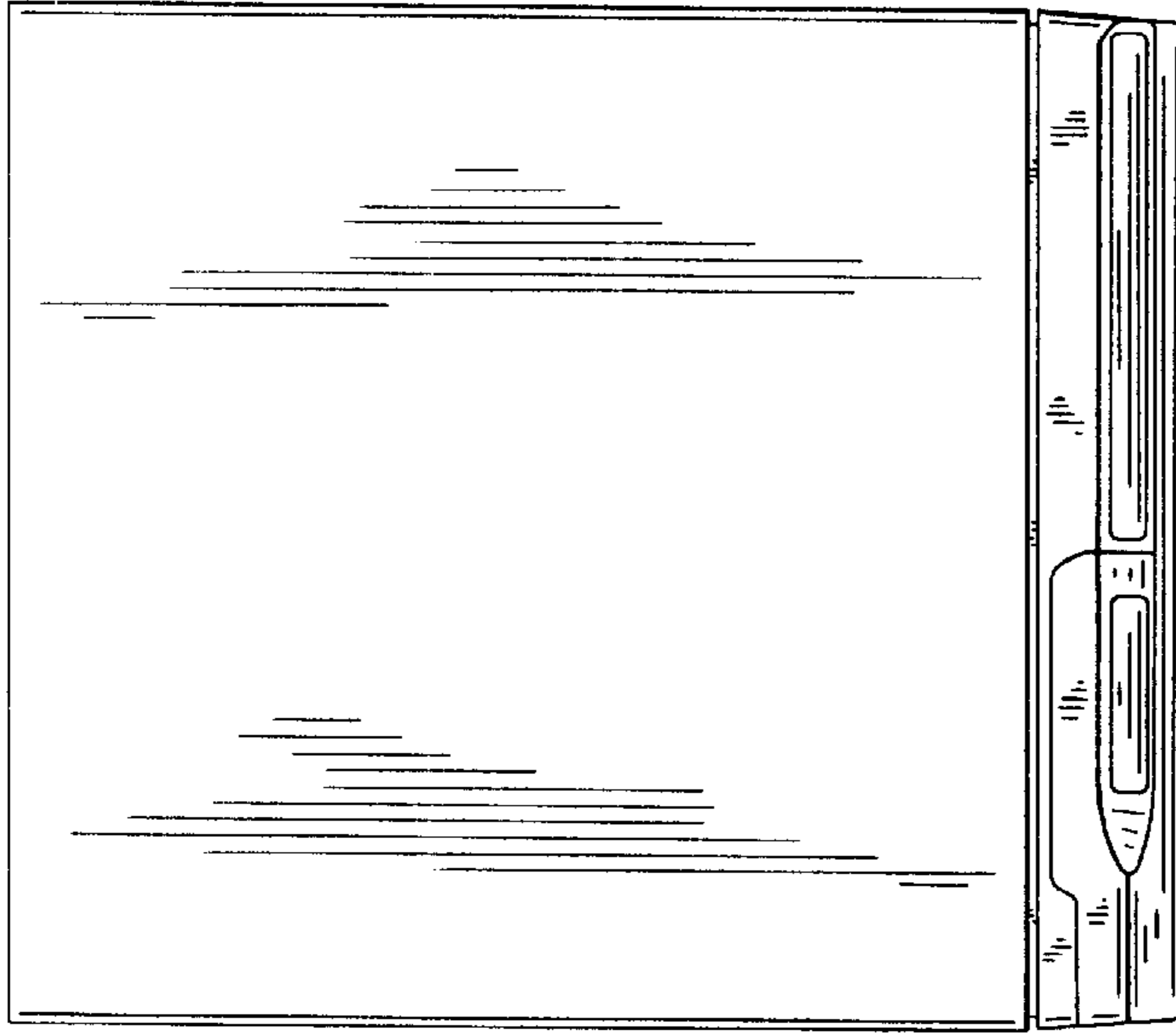

FIG. 11

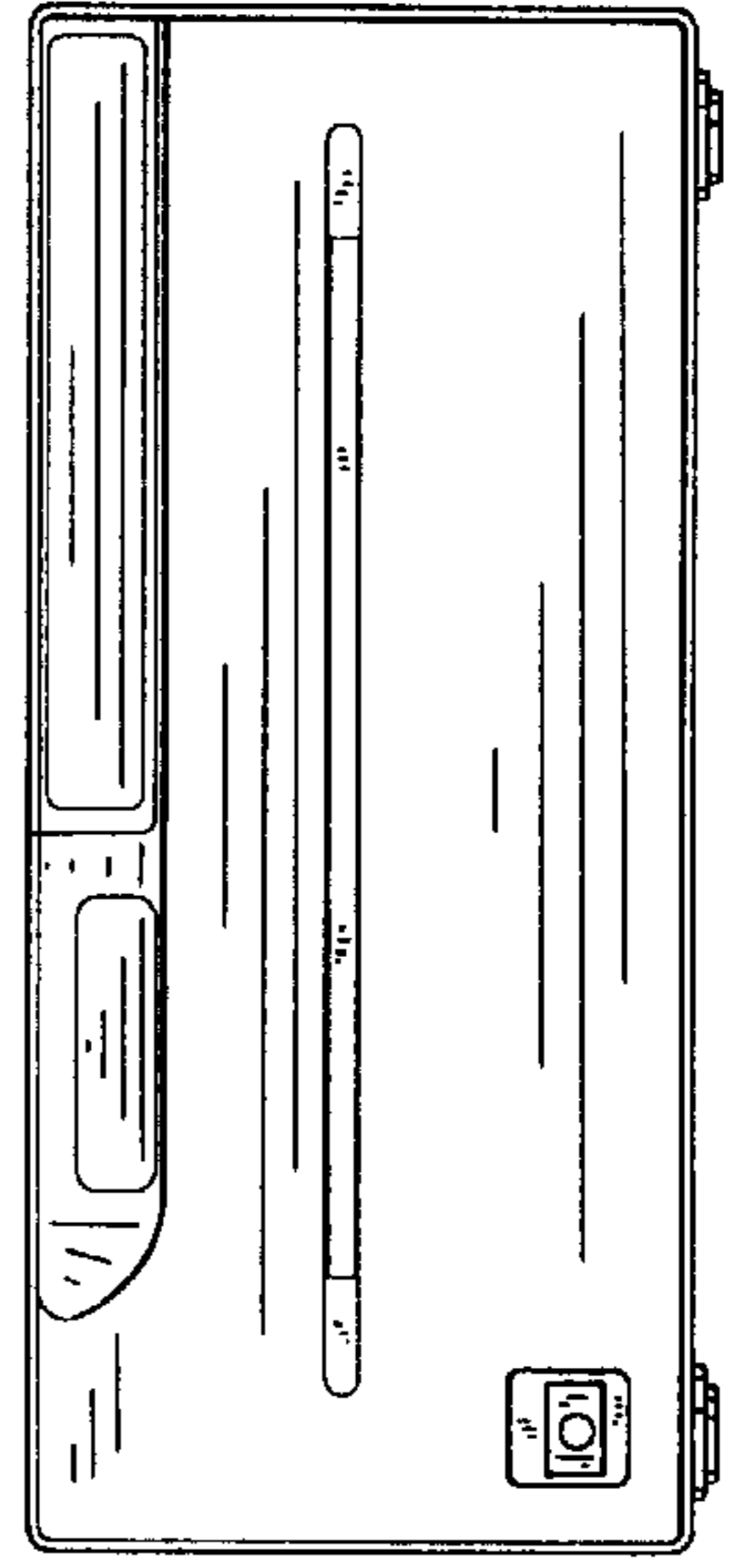

FIG. 10

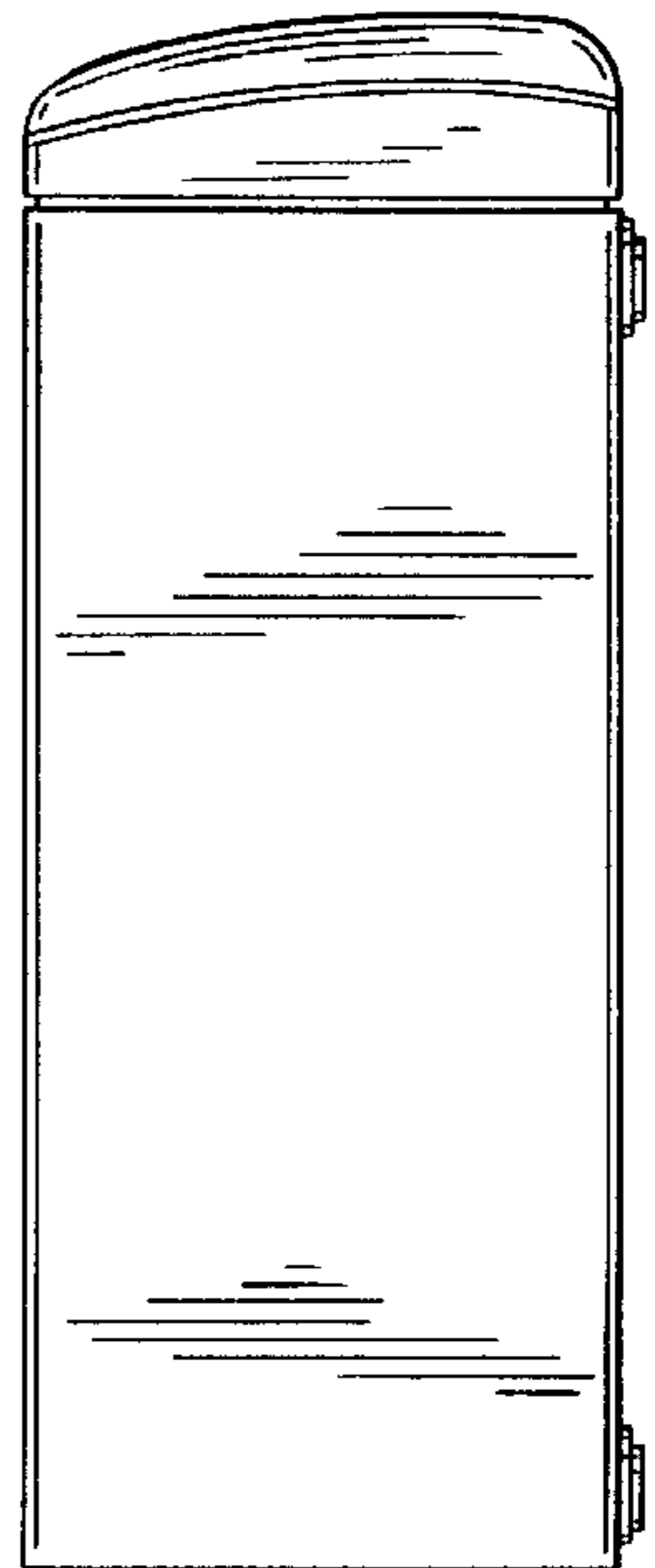

FIG. 14

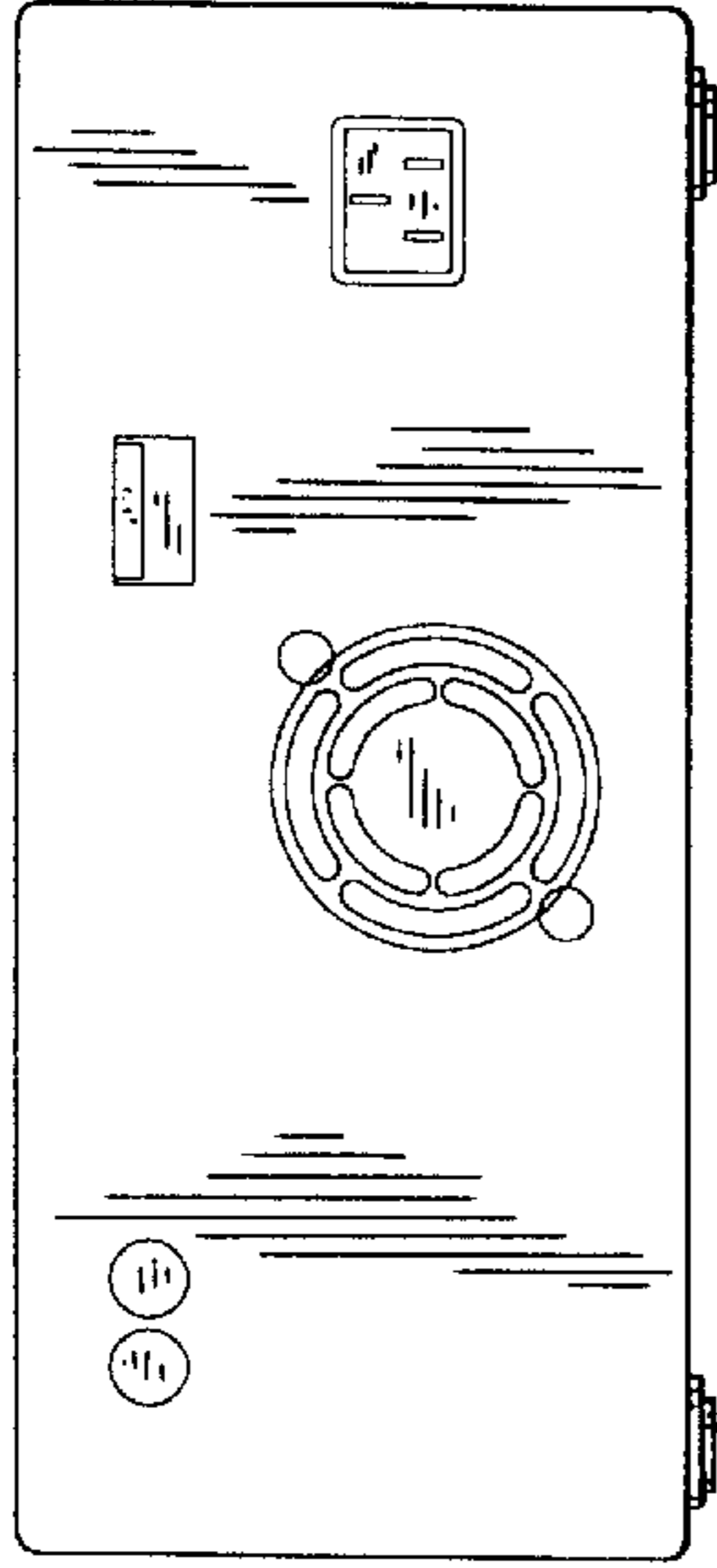

FIG. 12

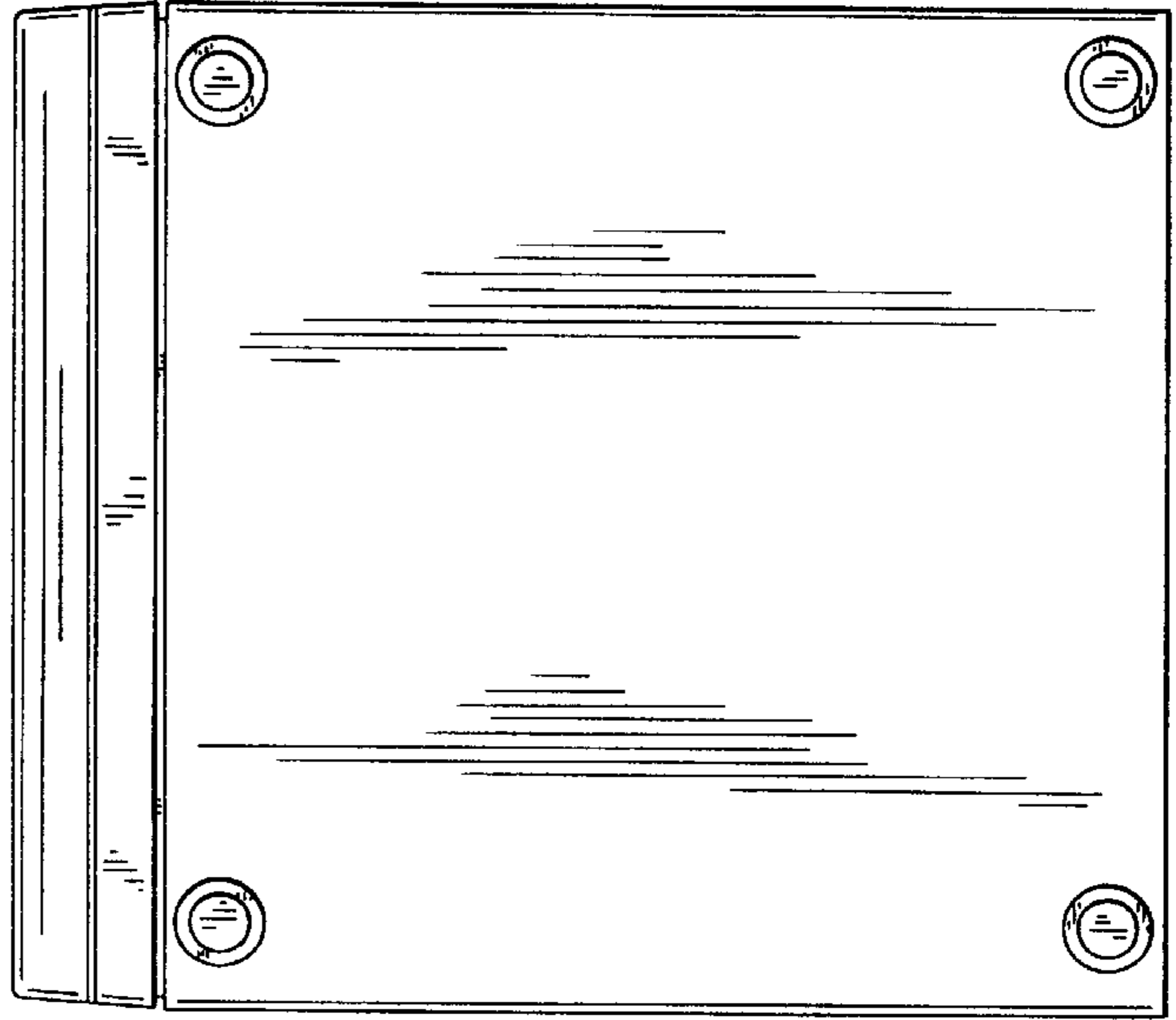

FIG. 13

