



US00D428048S

United States Patent [19]
Carsel

[11] **Patent Number: Des. 428,048**
[45] **Date of Patent: ** Jul. 11, 2000**

[54] **IMPRINTING ELEMENT**

[76] Inventor: **Dale Anthony Carsel**, 8316 Montello Rd., Independence, Ohio 44131

[**] Term: **14 Years**

[21] Appl. No.: **29/091,465**

[22] Filed: **Jul. 30, 1998**

D. 158,250	4/1950	Cosby, Jr.	D4/127
2,544,406	3/1951	Weems	101/483
2,789,301	4/1957	Harvey	401/130
3,161,903	12/1964	Worthington	15/244.1
4,030,414	6/1977	McGuire	101/379
5,542,352	8/1996	Blackman	101/483

Primary Examiner—Louis S. Zarfaz
Assistant Examiner—Greg Andoll
Attorney, Agent, or Firm—Howard M. Cohn

Related U.S. Application Data

[63] Continuation-in-part of application No. 08/783,603, Jan. 14, 1997, Pat. No. 5,857,411.

[51] **LOC (7) Cl.** **19-02**

[52] **U.S. Cl.** **D18/15**

[58] **Field of Search** D18/15; D19/41;
D4/127, 137, 138; D32/52; D8/DIG. 2;
15/244.1–244.4, 210.1, 210.5, 143.1; 101/405,
406, 379, 380, 368, 333, 382.1, 401.1,
483; 401/6, 88, 118, 130, 138, 196; 198/206,
207, 261, 262, 266

[56] **References Cited**

U.S. PATENT DOCUMENTS

D. 51,319	10/1917	Montgomery	D4/127
D. 143,807	2/1946	Eastham	D8/DIG. 2

[57] **CLAIM**

I claim the ornamental design of an imprinting element, as shown and described.

DESCRIPTION

FIG. 1 is a perspective view of an imprinting element in accordance with the design.
FIG. 2 is a top view of the imprinting element of FIG. 1; FIG. 3 is a bottom view of the imprinting element of FIG. 1;
FIG. 4 is a side view through line 4—4 of FIG. 2;
FIG. 5 is a side view through line 5—5 of FIG. 2;
FIG. 6 is a side view through line 6—6 of FIG. 2; and,
FIG. 7 is a side view through line 7—7 of FIG. 2.
The broken lines in the figures for illustrative purposes only and forms no part of the claimed design.

1 Claim, 3 Drawing Sheets

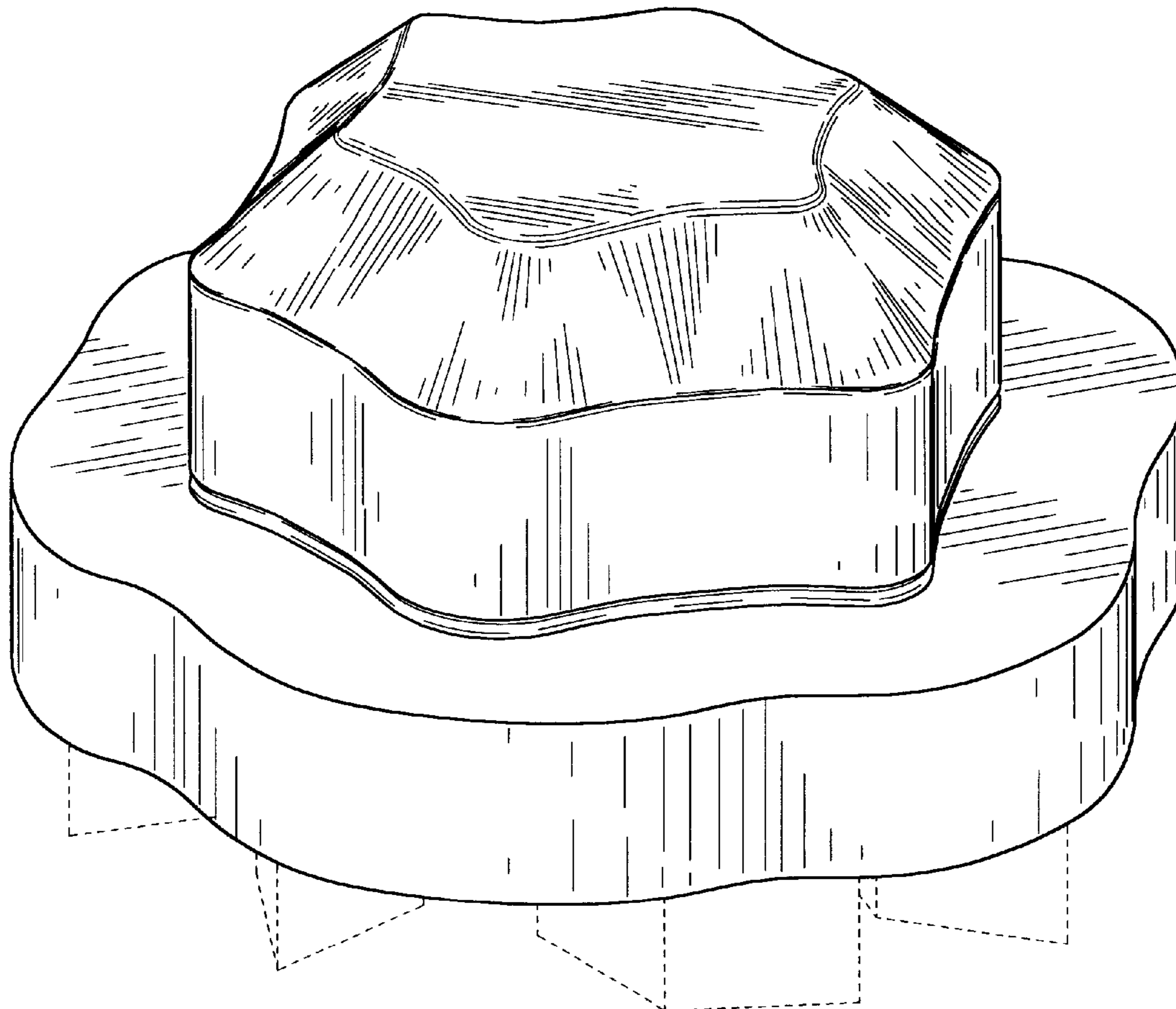

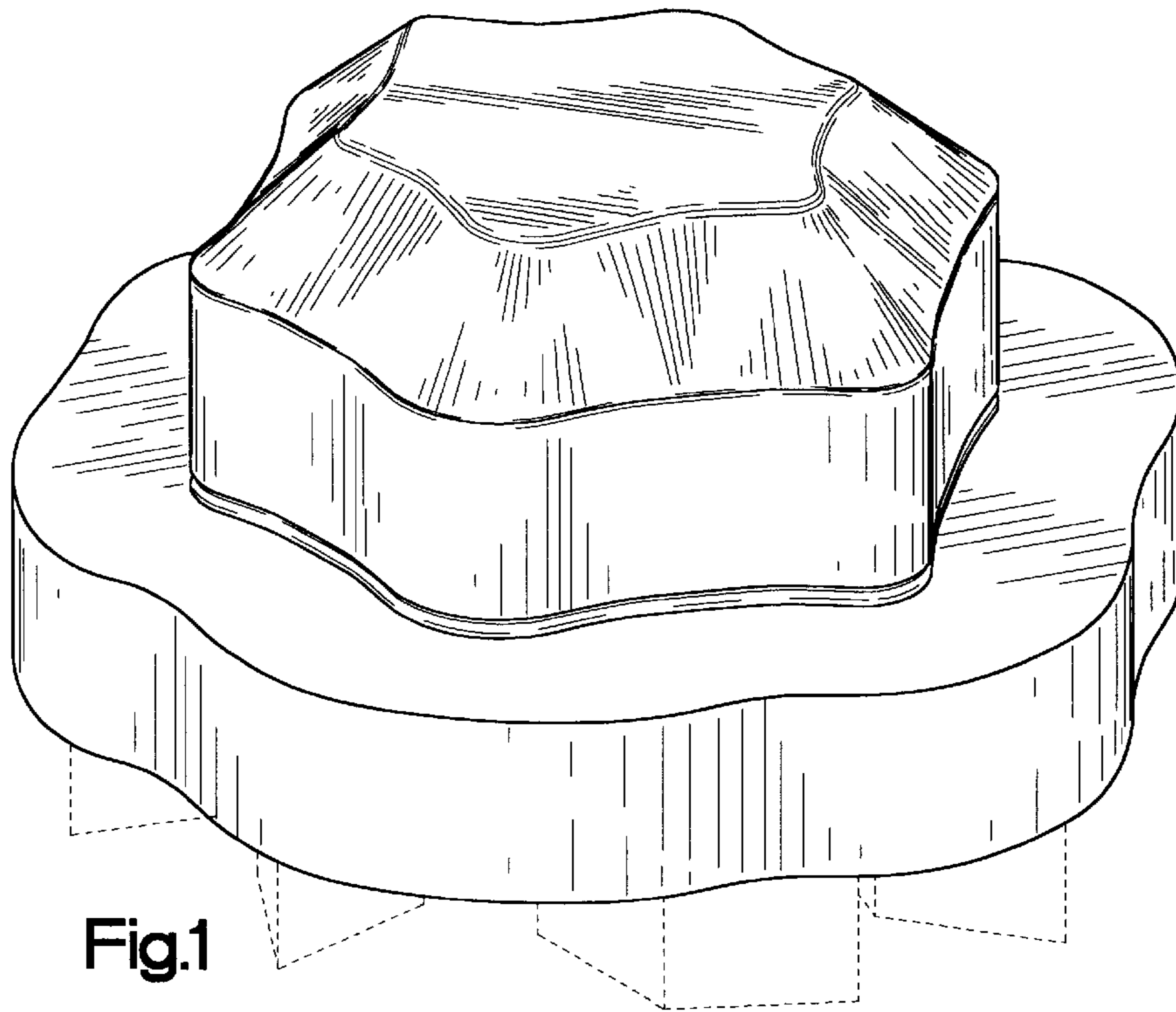

Fig.1

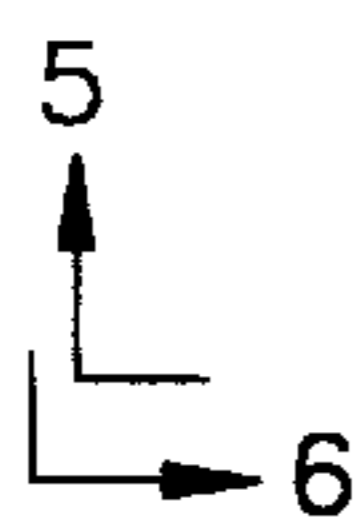
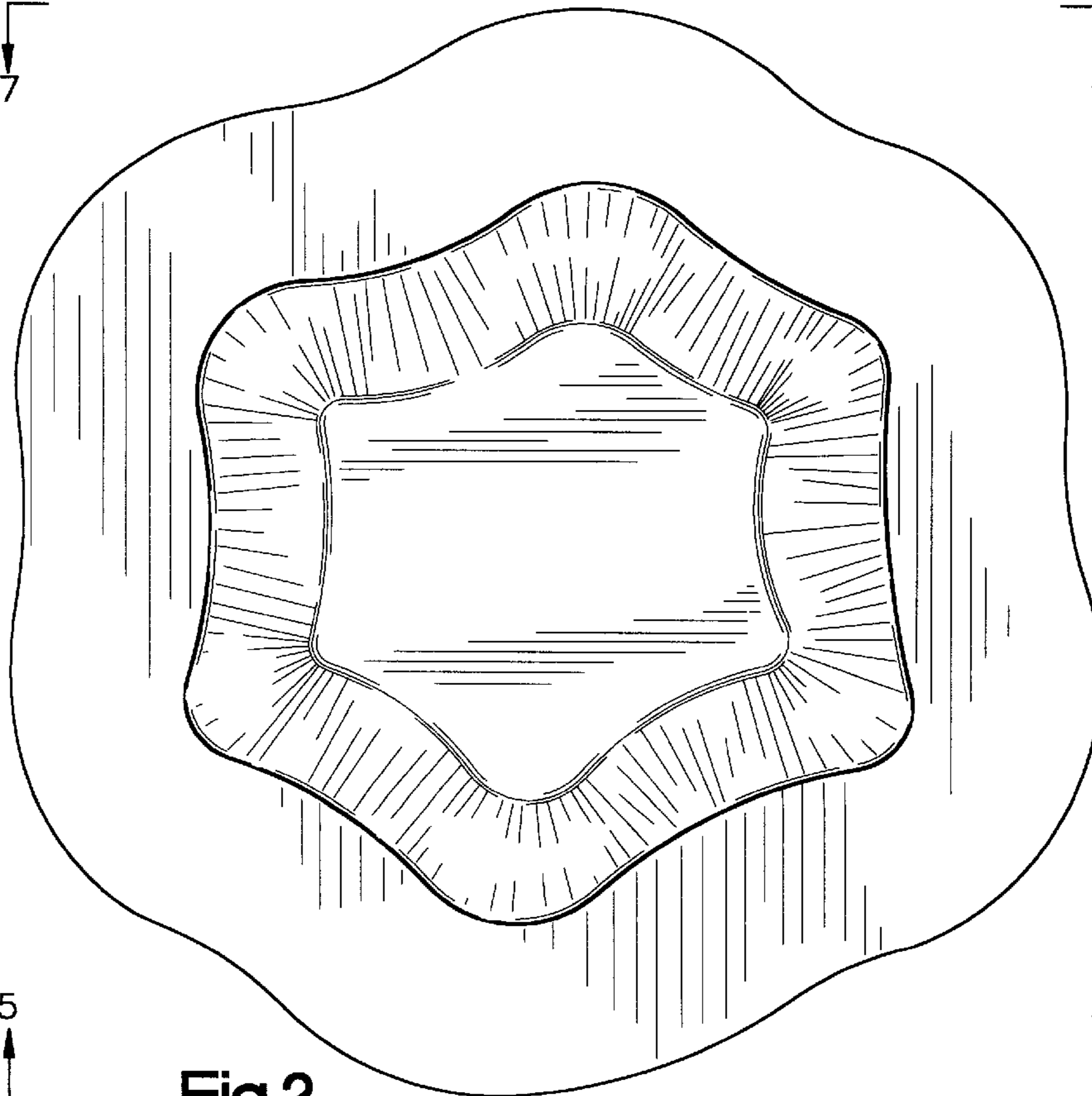
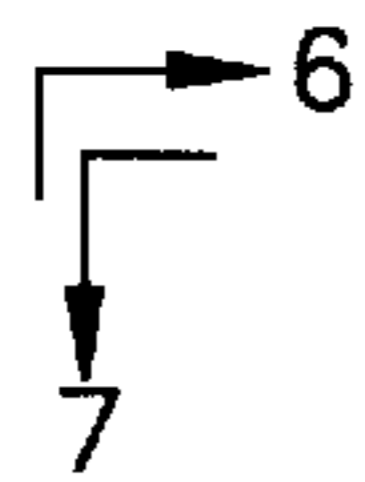
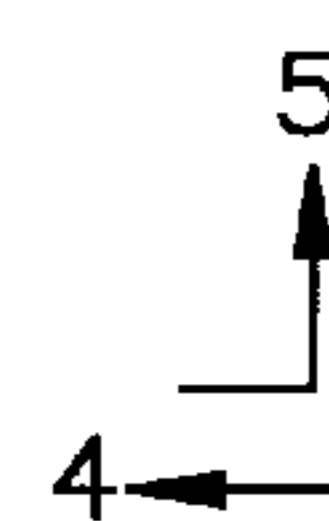

Fig.2



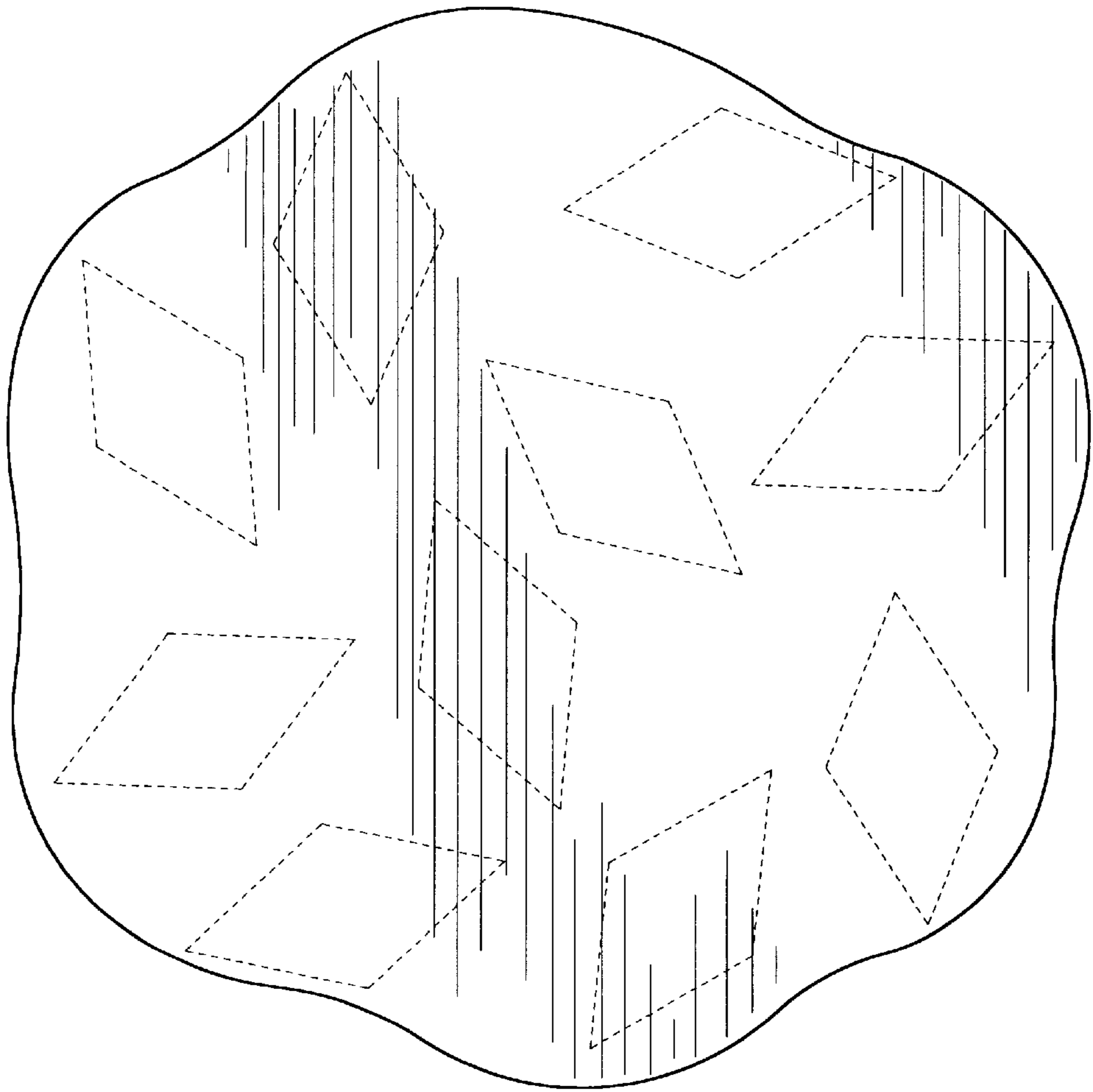

Fig.3

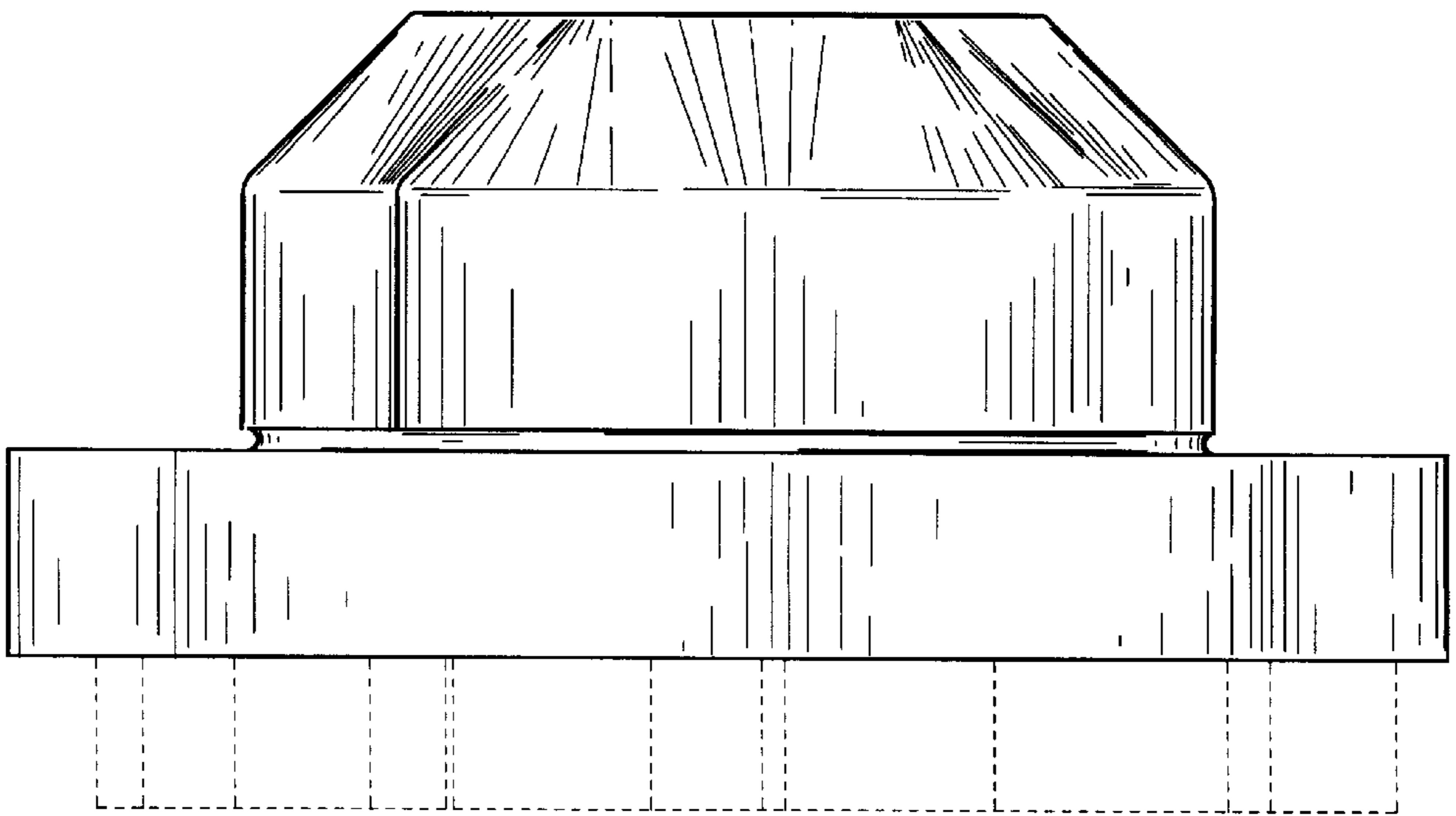

Fig.4

Fig.5

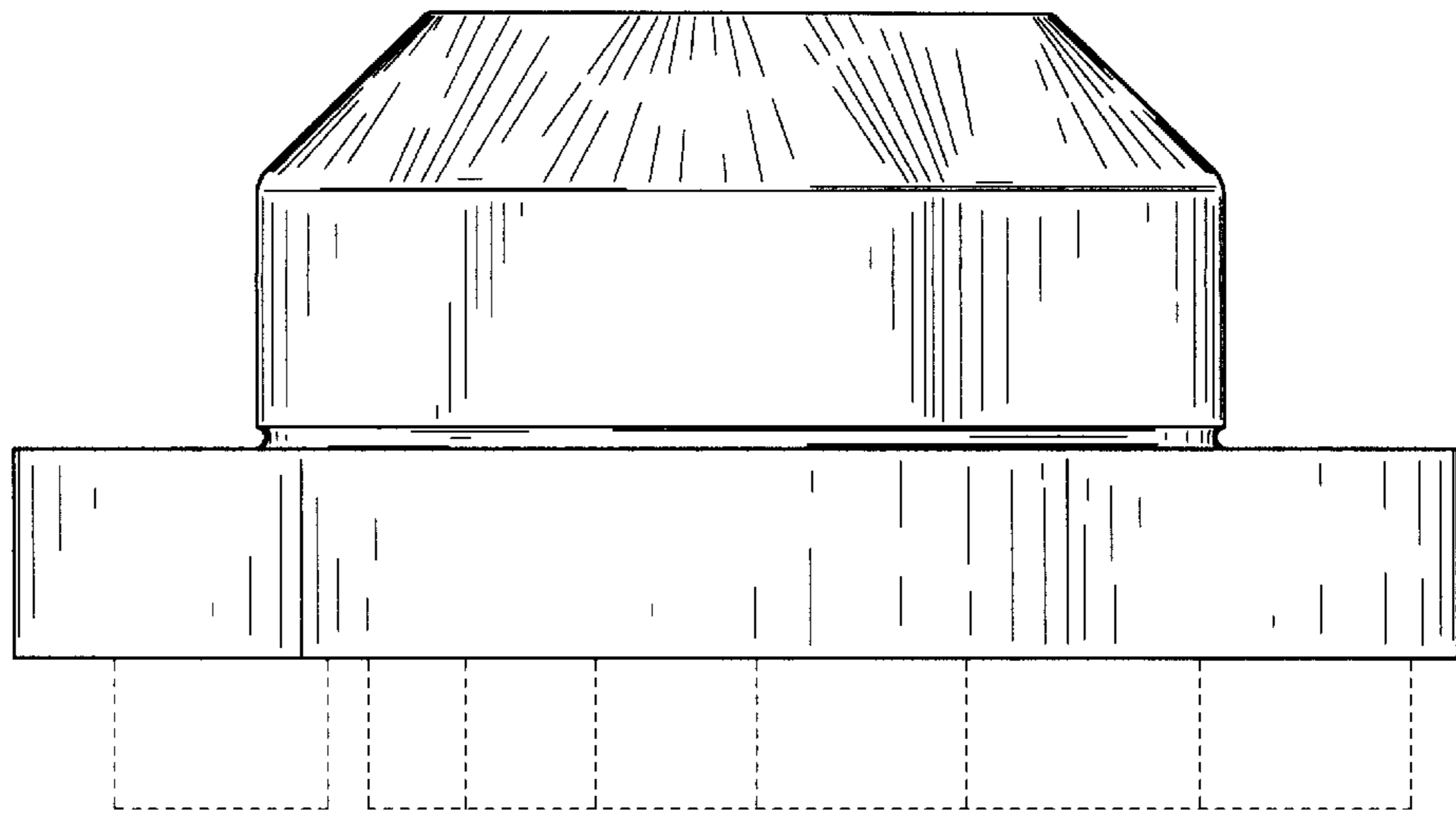

Fig.6

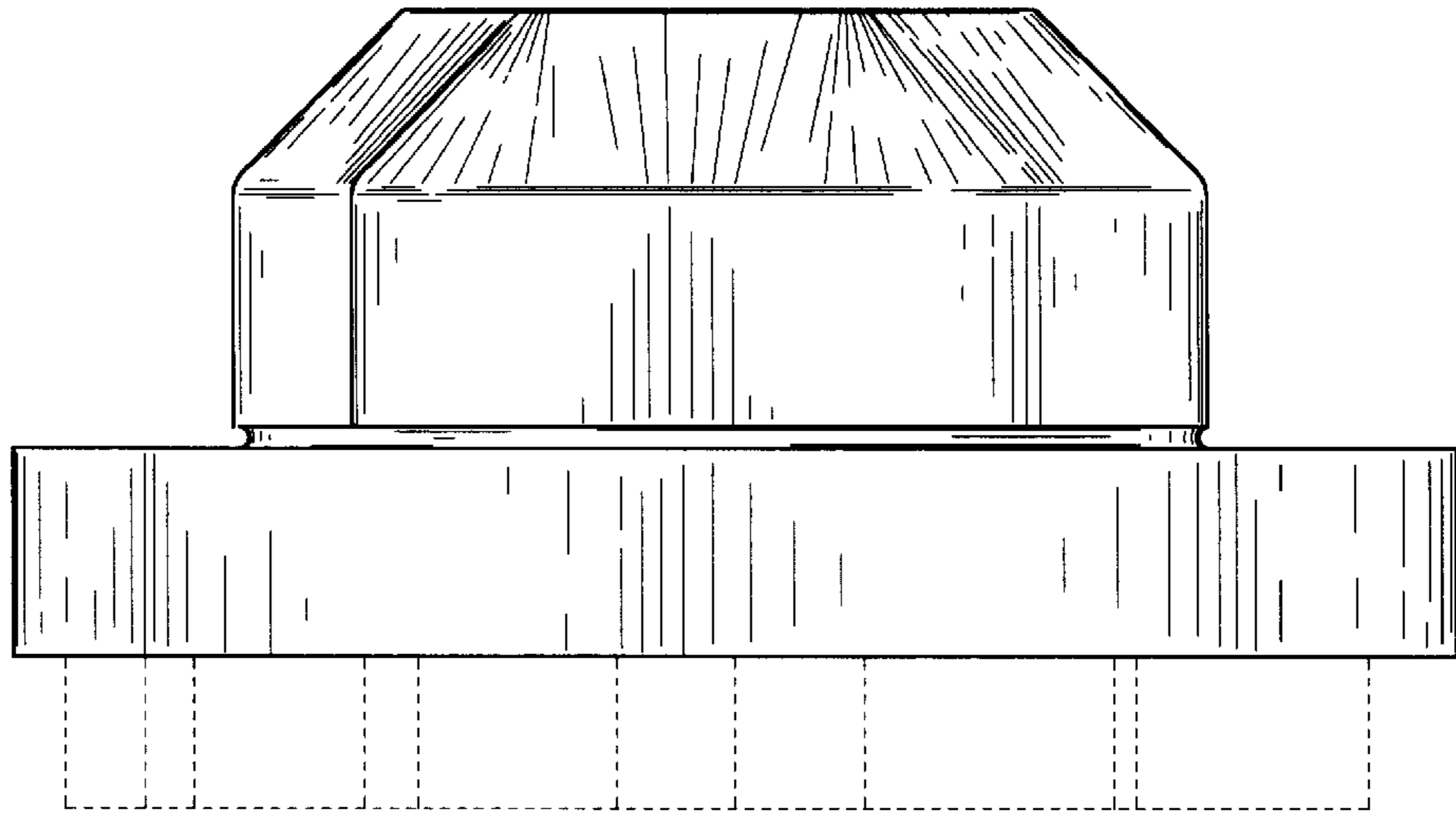

Fig.7

