



US00D427986S

United States Patent [19]

Webb et al.

[11] Patent Number: Des. 427,986

[45] Date of Patent: ** Jul. 11, 2000

[54] DICTATION MASK

[75] Inventors: **Stephen D. Webb**, Victoria, Canada;
Garn H. Webb, Alpharetta, Ga.;
Andrew P. King, Victoria, Canada

[73] Assignee: **Talk Technologies Inc.**, Victoria,
Canada

[**] Term: 14 Years

[21] Appl. No.: 29/092,537

[22] Filed: Aug. 20, 1998

[51] LOC (7) Cl. 14-01

[52] U.S. Cl. D14/154

[58] Field of Search D14/154, 158,
D14/159; D24/110.1, 110.2, 110.4, 110.5;
D29/108; 2/9, 173, 206; 192/995; 369/260

[56] **References Cited**

U.S. PATENT DOCUMENTS

D. 177,947	6/1956	Sherwood	D14/154
D. 236,033	7/1975	Dryden	D24/110.1
D. 303,440	9/1989	Campbell	D24/110.1

D. 355,484	2/1995	Rinehart	D24/110.1
2,117,236	1/1938	Bread et al.	369/260 X
2,526,177	10/1950	Webb	179/183
2,572,547	10/1951	Webb	179/188
2,625,615	1/1953	Webb	179/188
2,857,013	10/1958	Orso	181/34
3,193,624	7/1965	Webb et al.	179/188
3,796,842	3/1974	Guille	179/188
4,129,754	12/1978	Gore	179/188

Primary Examiner—Nanda Bondade
Attorney, Agent, or Firm—Foster & Foster

[57] **CLAIM**

The ornamental design for a dictation mask, as shown and described.

DESCRIPTION

FIG. 1 is an isometric view of a dictation mask showing our new design;
FIG. 2 is a top plan view thereof;
FIG. 3 is a bottom plan view thereof;
FIG. 4 is a rear elevational view thereof;
FIG. 5 is a front elevational view thereof; and,
FIG. 6 is a side elevational view thereof.

1 Claim, 3 Drawing Sheets

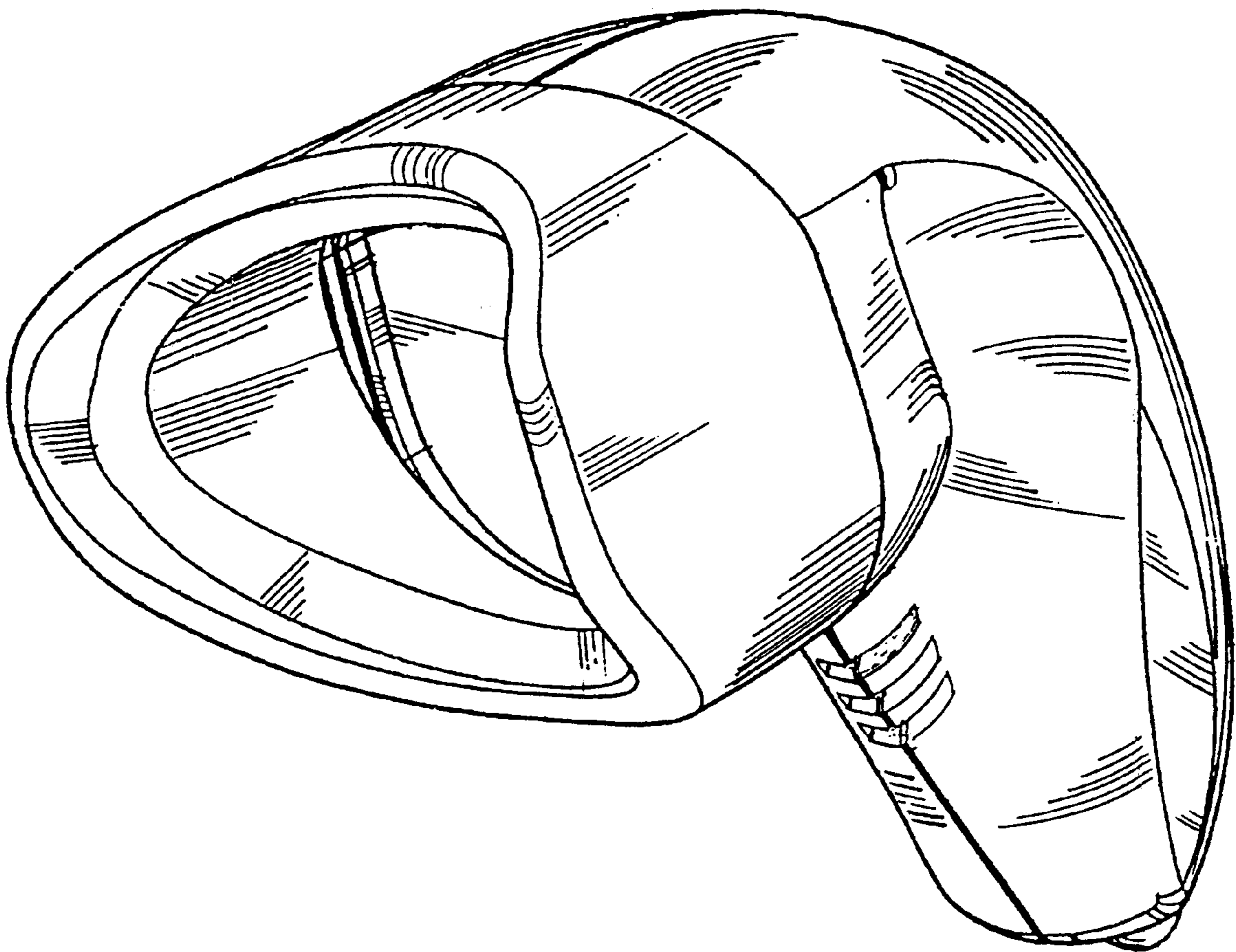

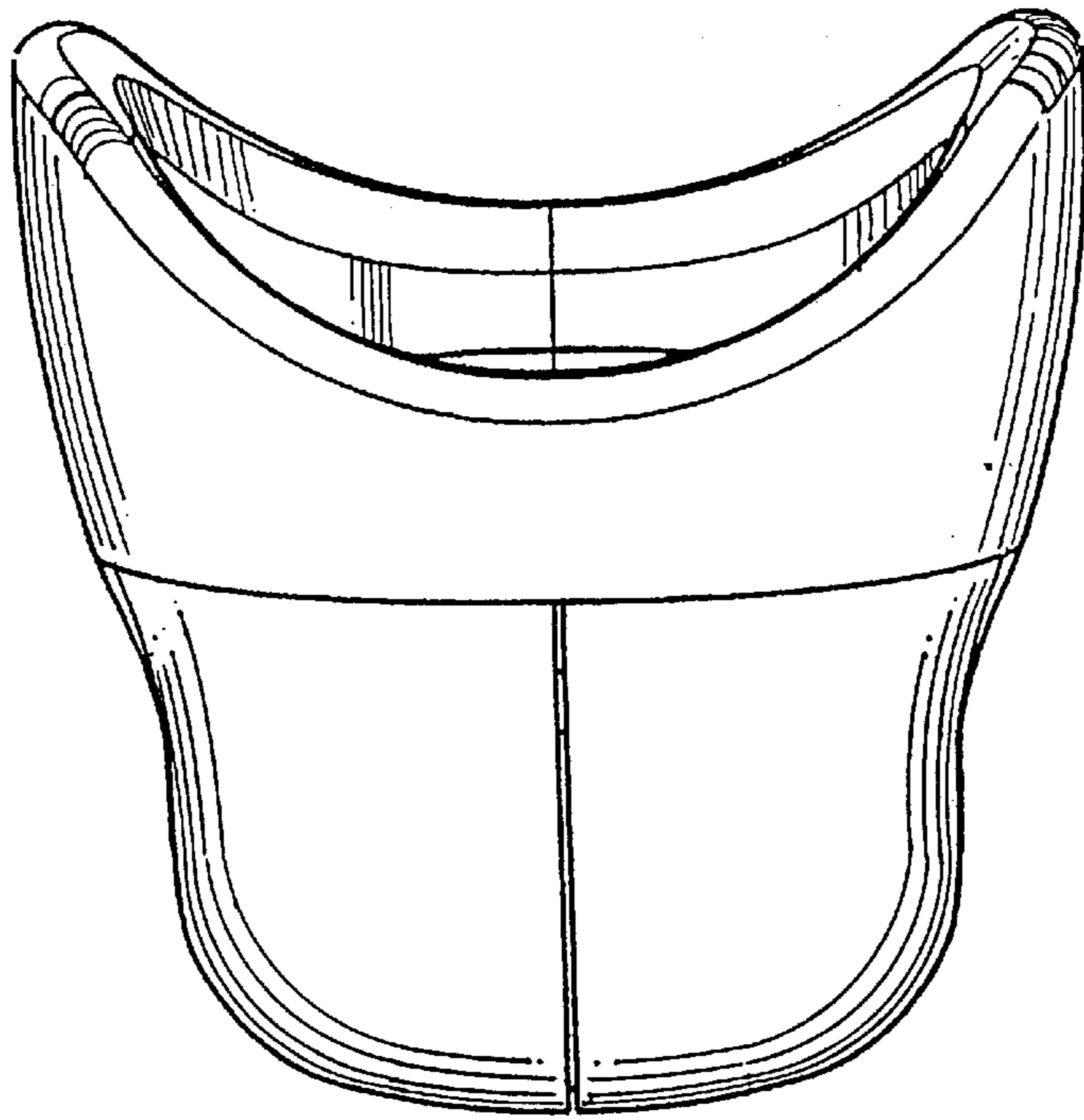

FIGURE 2

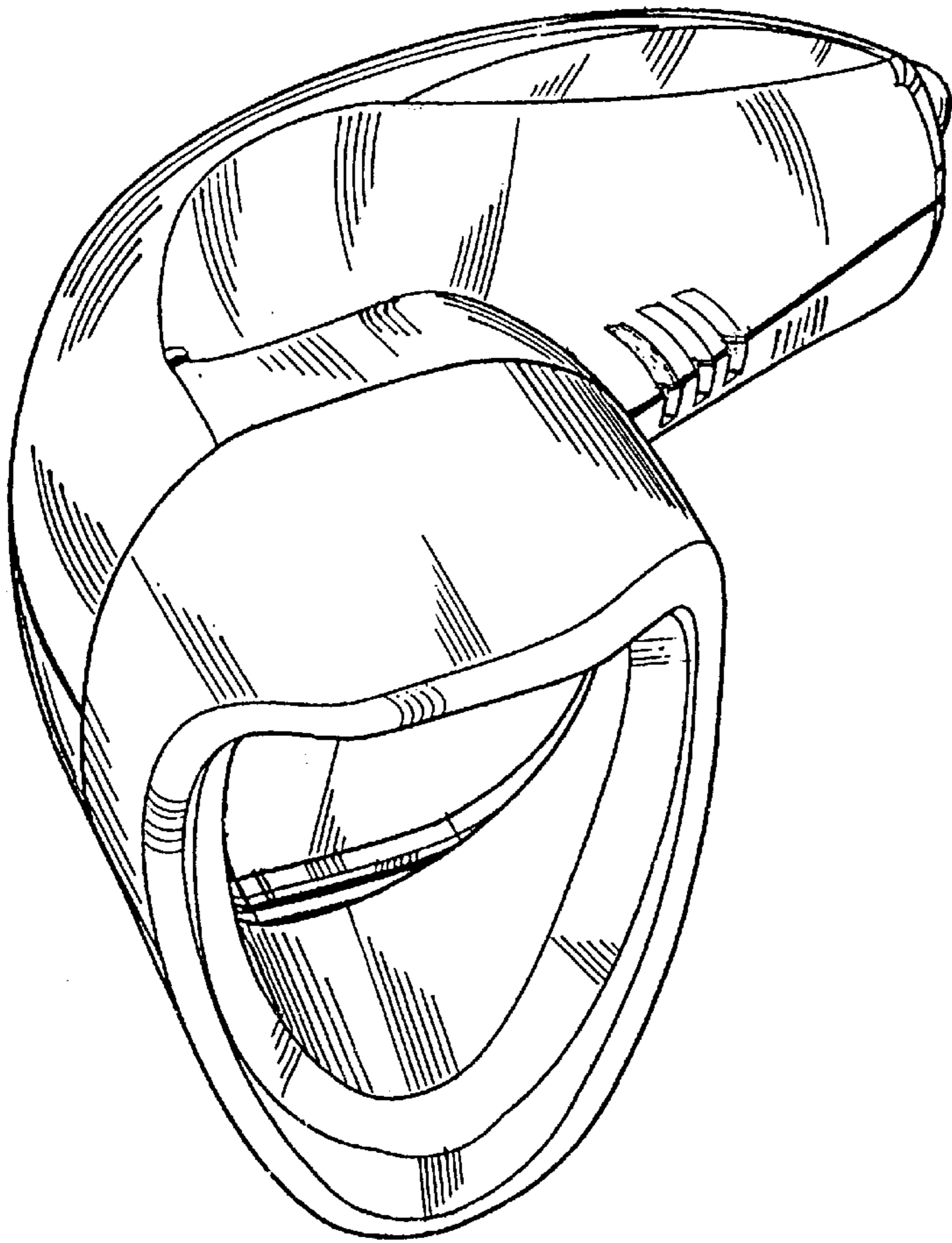

FIGURE 1

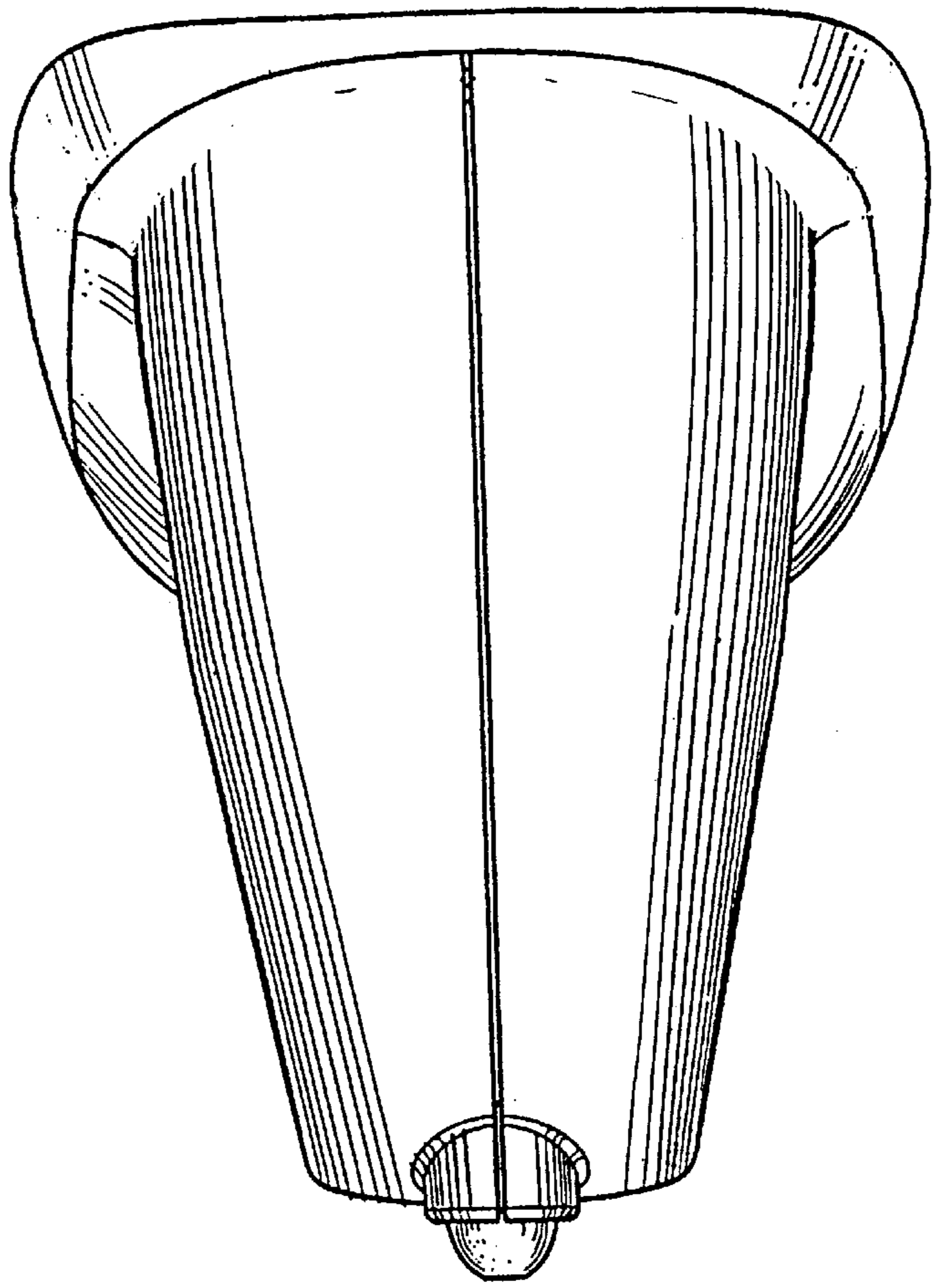

FIGURE 4

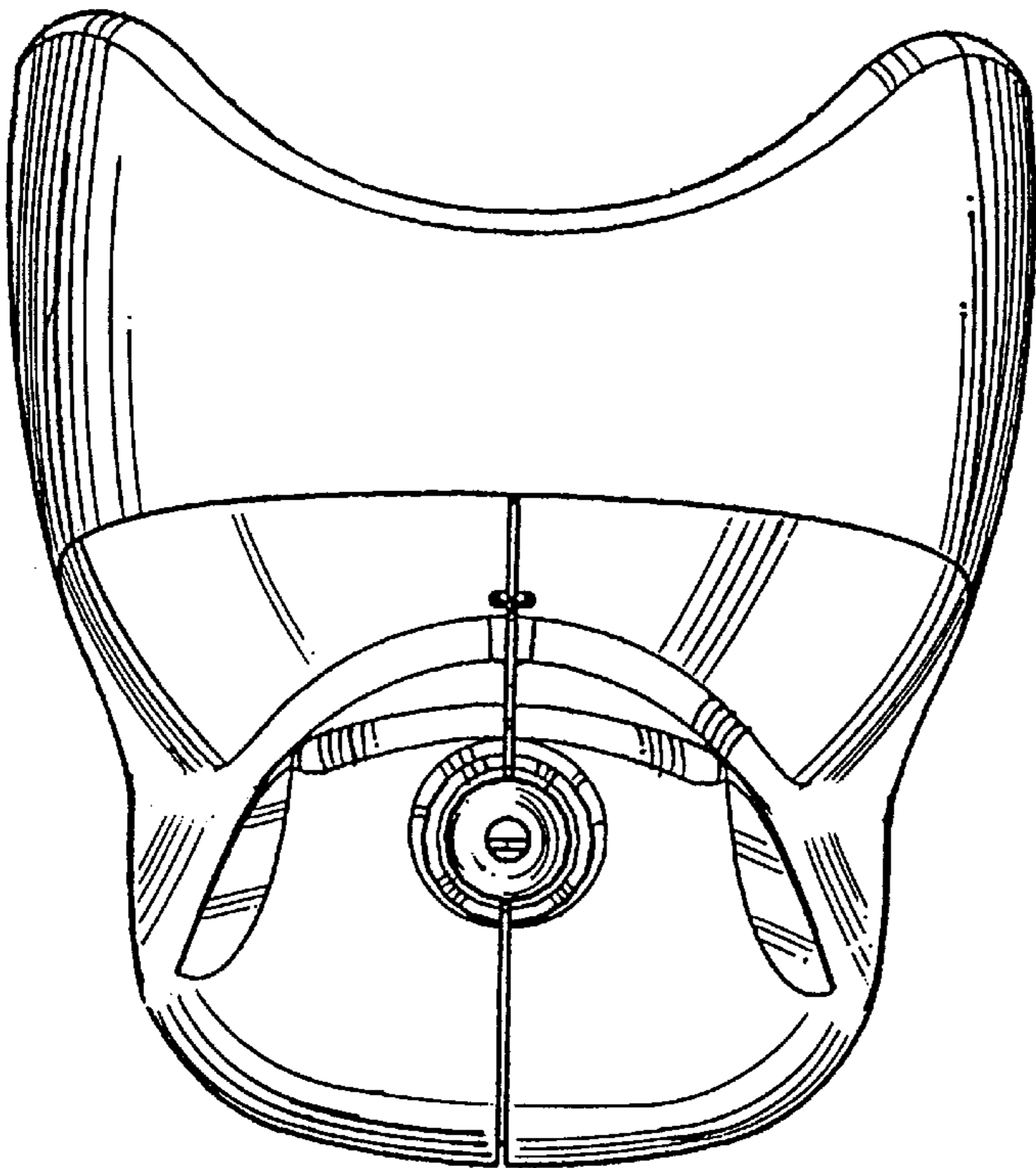

FIGURE 3

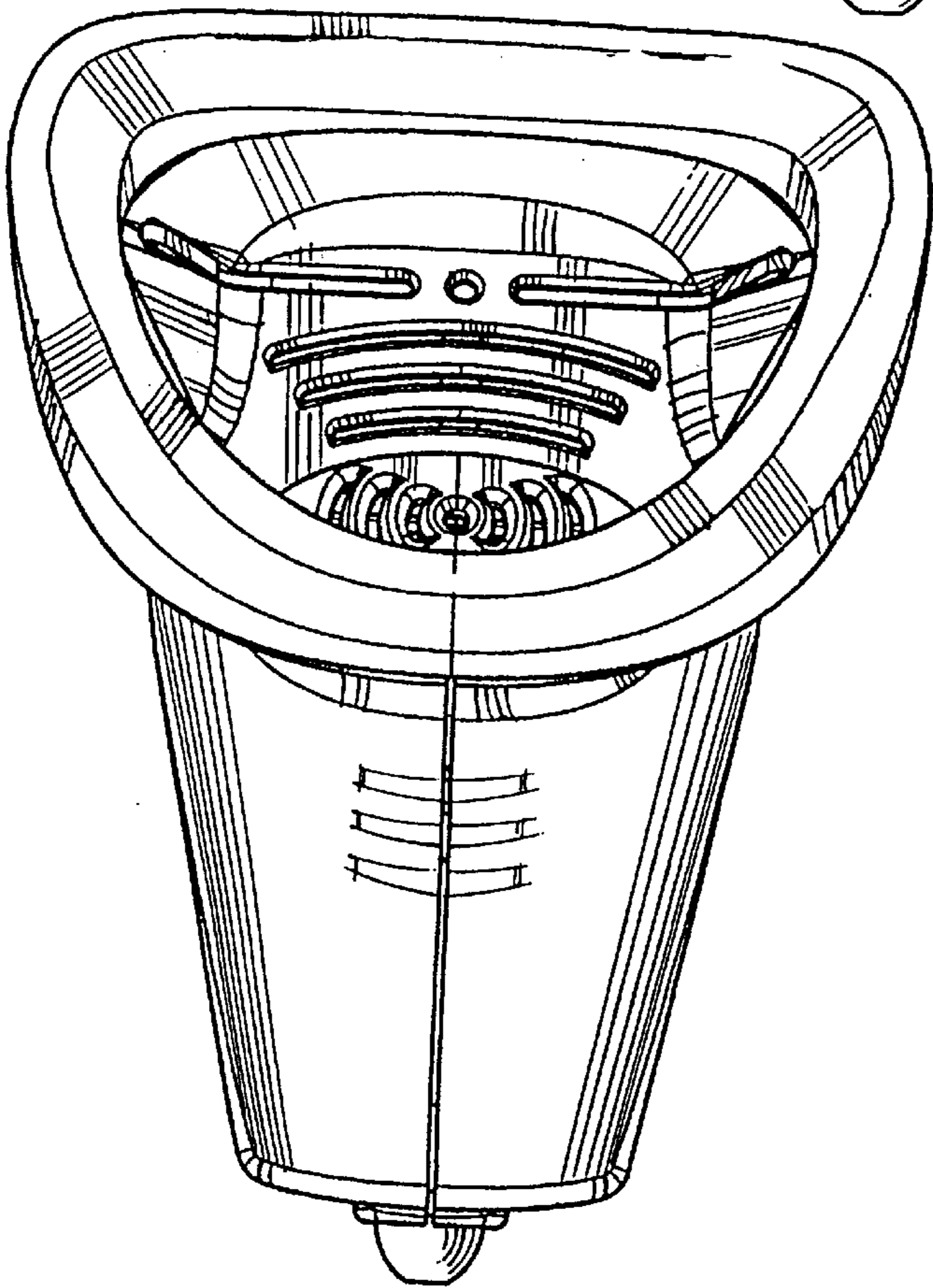

FIGURE 5

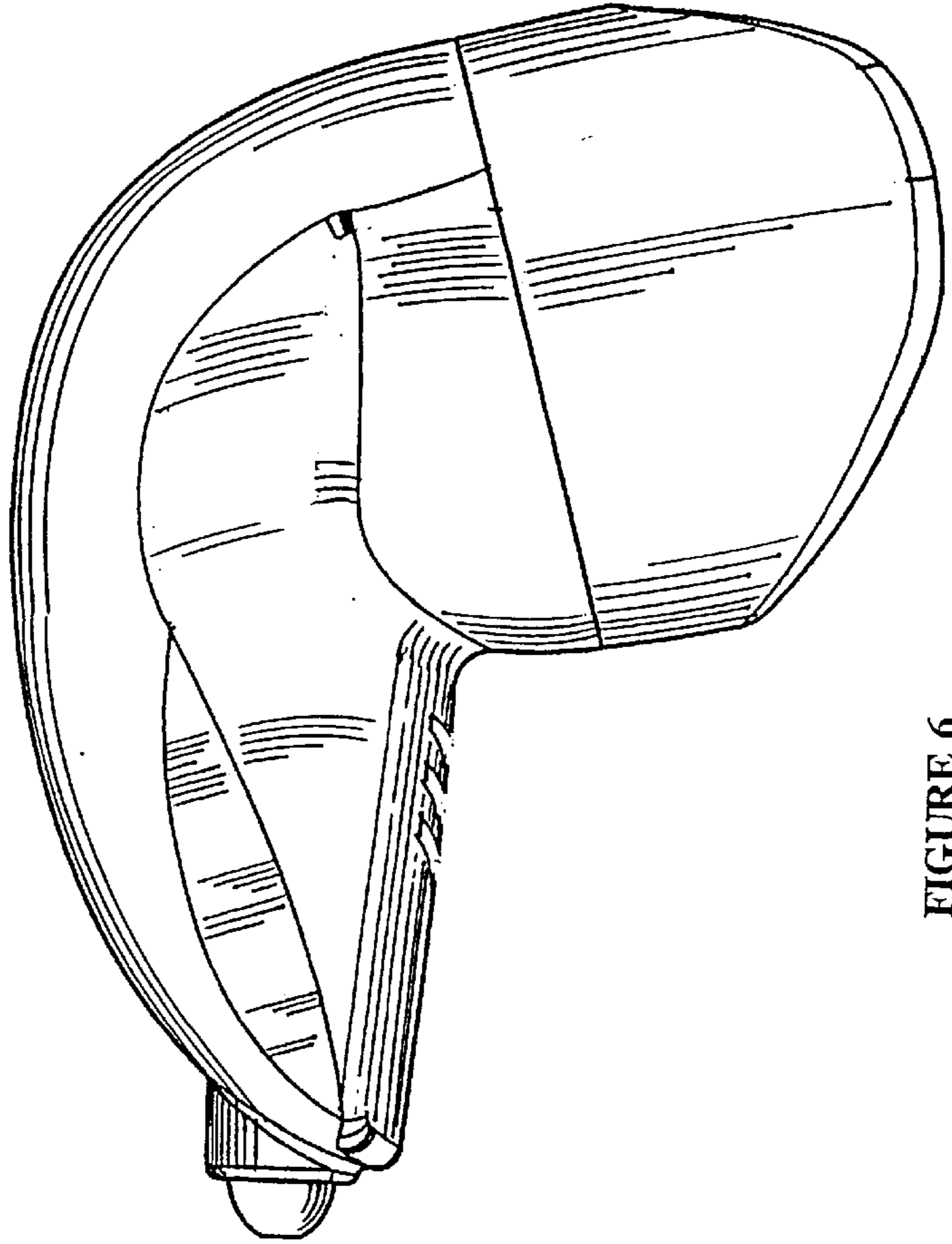

FIGURE 6