



US00D427935S

United States Patent [19]

Anderson et al.

[11] Patent Number: **Des. 427,935**

[45] Date of Patent: **** Jul. 11, 2000**

[54] **CHRISTMAS TREE ORNAMENT DISPLAY**

D. 408,319	4/1999	Byers	D11/118
1,791,533	2/1931	Parmele	428/18
5,338,585	8/1994	Fraus et al.	428/18

[76] Inventors: **Garry E. Anderson**, 4047 Meath Ct., Dublin, Ohio 43016; **Beverly S. Anderson**, 1796 Pheasant Run W. Apt. B, Columbus, Ohio 43228

Primary Examiner—Dominic Simone
Attorney, Agent, or Firm—Standley & Gilcrest LLP

[**] Term: **14 Years**

[57] CLAIM

[21] Appl. No.: **29/105,661**

The ornamental design for a Christmas tree ornament display, as shown and described.

[22] Filed: **May 28, 1999**

DESCRIPTION

[51] **LOC (7) Cl.** **11-05**

FIG. 1 is a perspective view of a Christmas tree ornament display showing my new design;
FIG. 2 is a top plan view thereof;
FIG. 3 is a front elevational view thereof;
FIG. 4 is a rear elevational view thereof;
FIG. 5 is a bottom plan view thereof;
FIG. 6 is a right side elevational view thereof; and,
FIG. 7 is a left side elevational view thereof.

[52] **U.S. Cl.** **D11/118; D11/125**

[58] **Field of Search** D11/117, 118, D11/121, 125; 428/18; 362/123

The star in FIG. 1, and the cords in FIGS. 2, 4, 6 and 7, are shown in broken lines for illustrative purposes only and form no part of the claimed design.

[56] References Cited

U.S. PATENT DOCUMENTS

D. 107,668	12/1937	Wadsworth et al.	D11/118
D. 163,434	5/1951	Willis	D11/118
D. 203,446	1/1966	Napier	D11/118
D. 234,432	3/1975	Boganowski et al.	D11/118
D. 327,232	6/1992	Winn	D11/118
D. 387,699	12/1997	Chen	D11/118

1 Claim, 4 Drawing Sheets

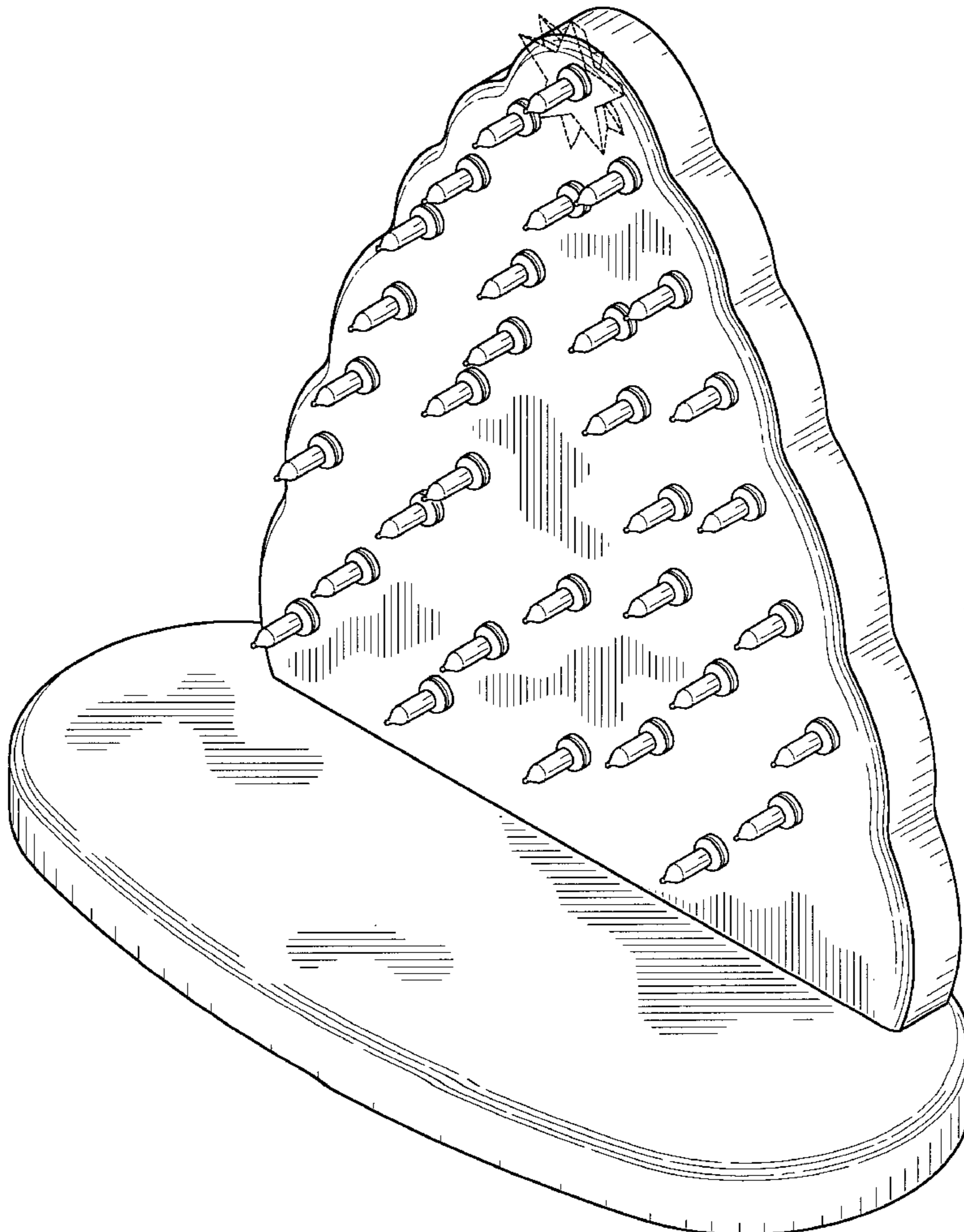

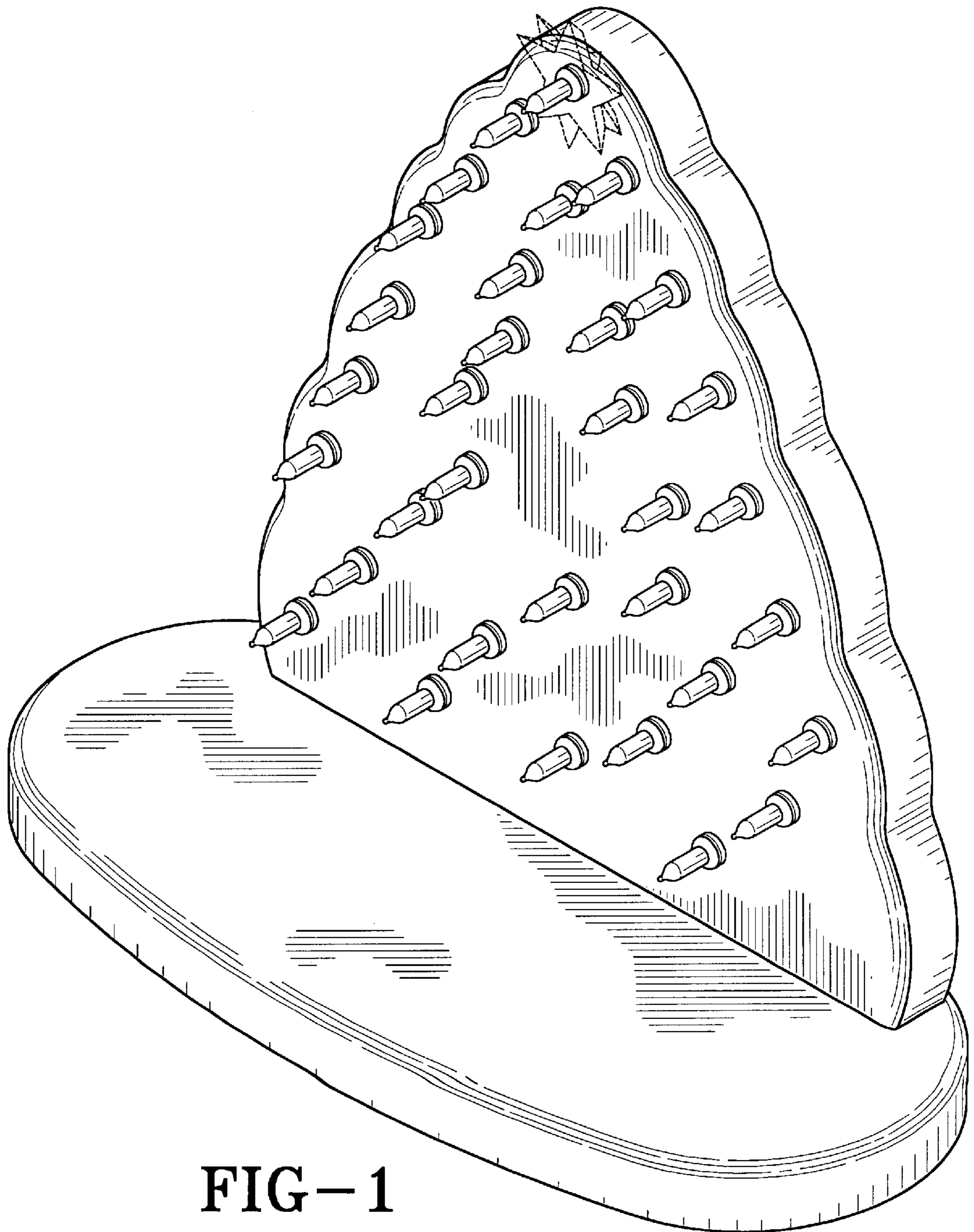

FIG-1

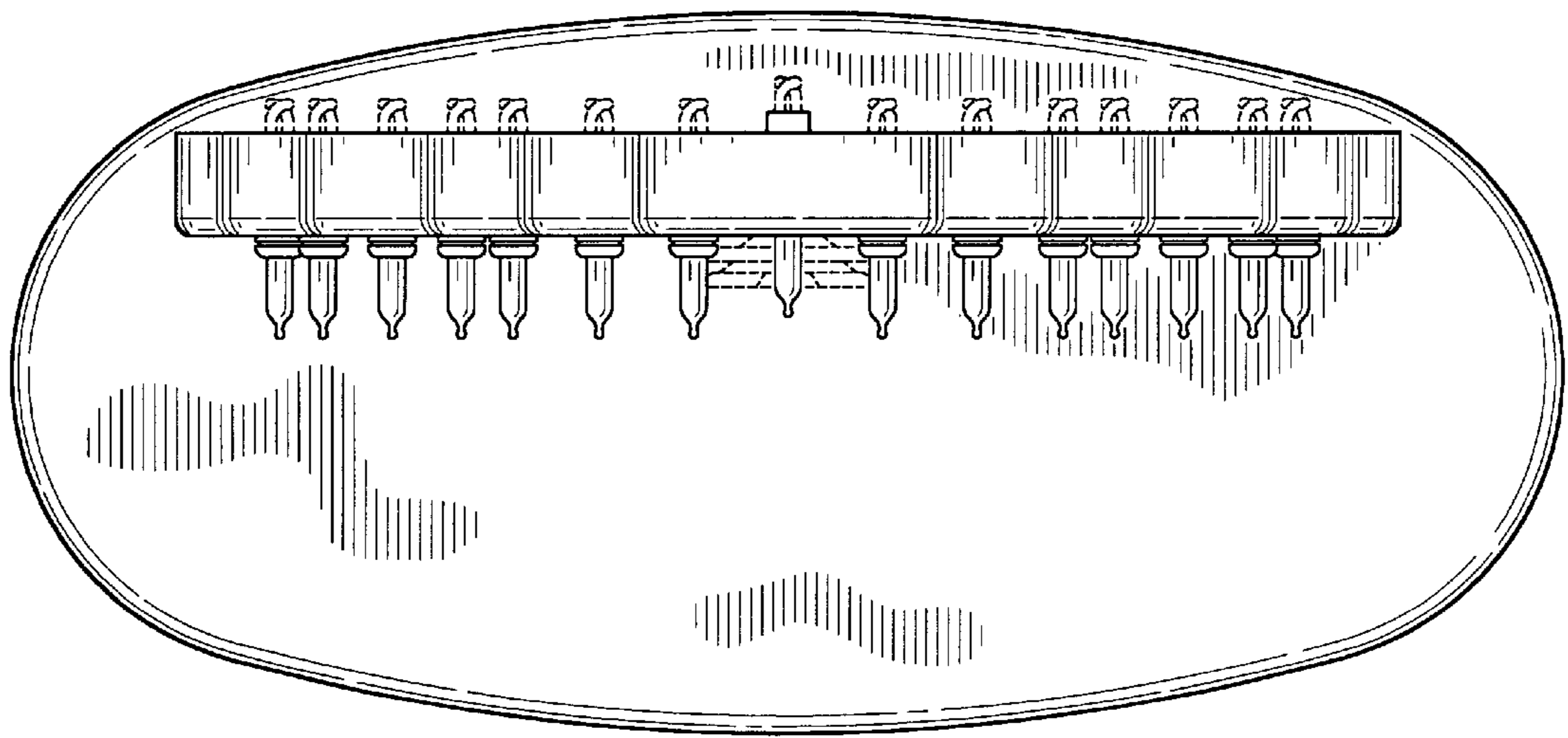

FIG-2

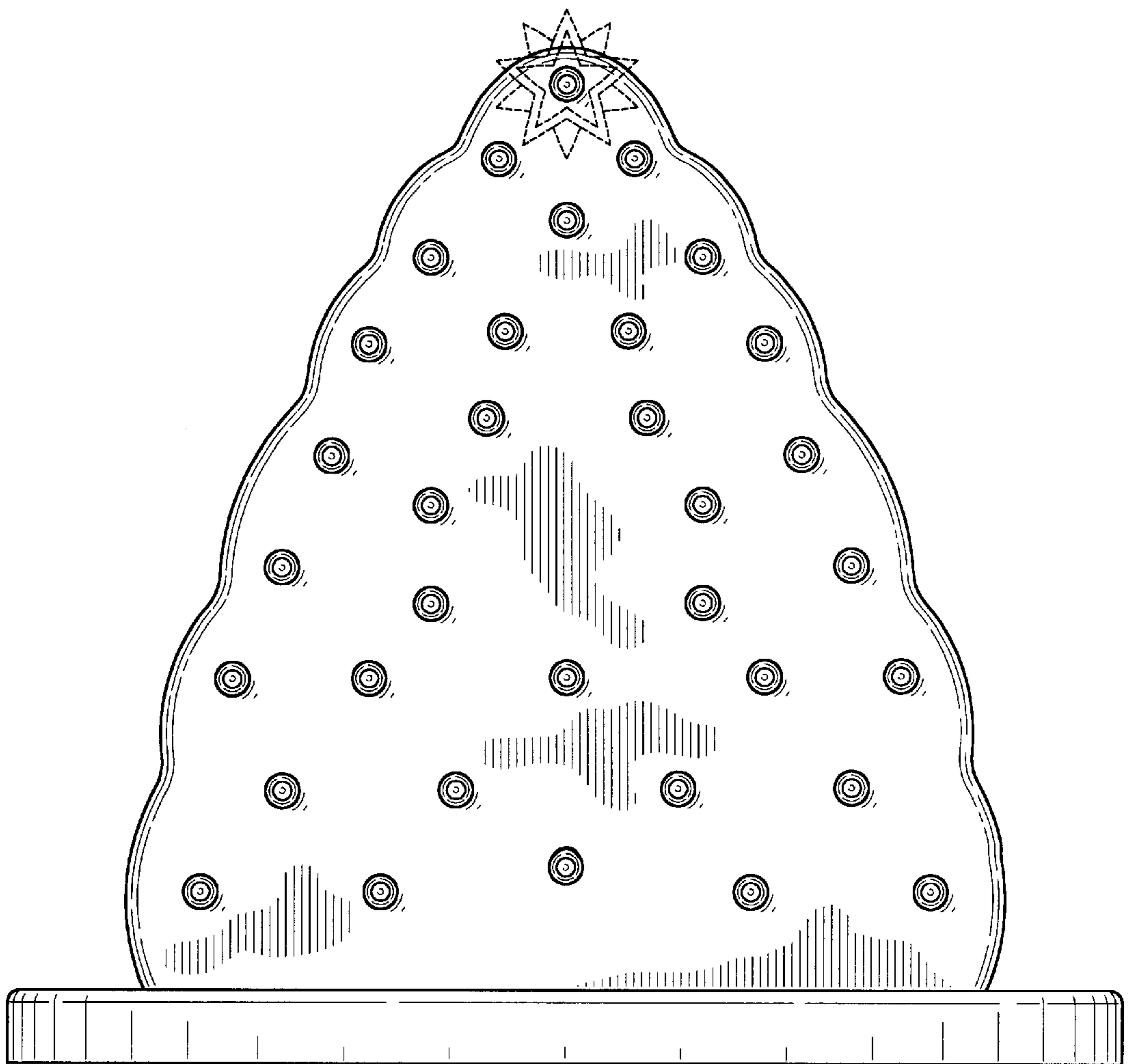

FIG-3

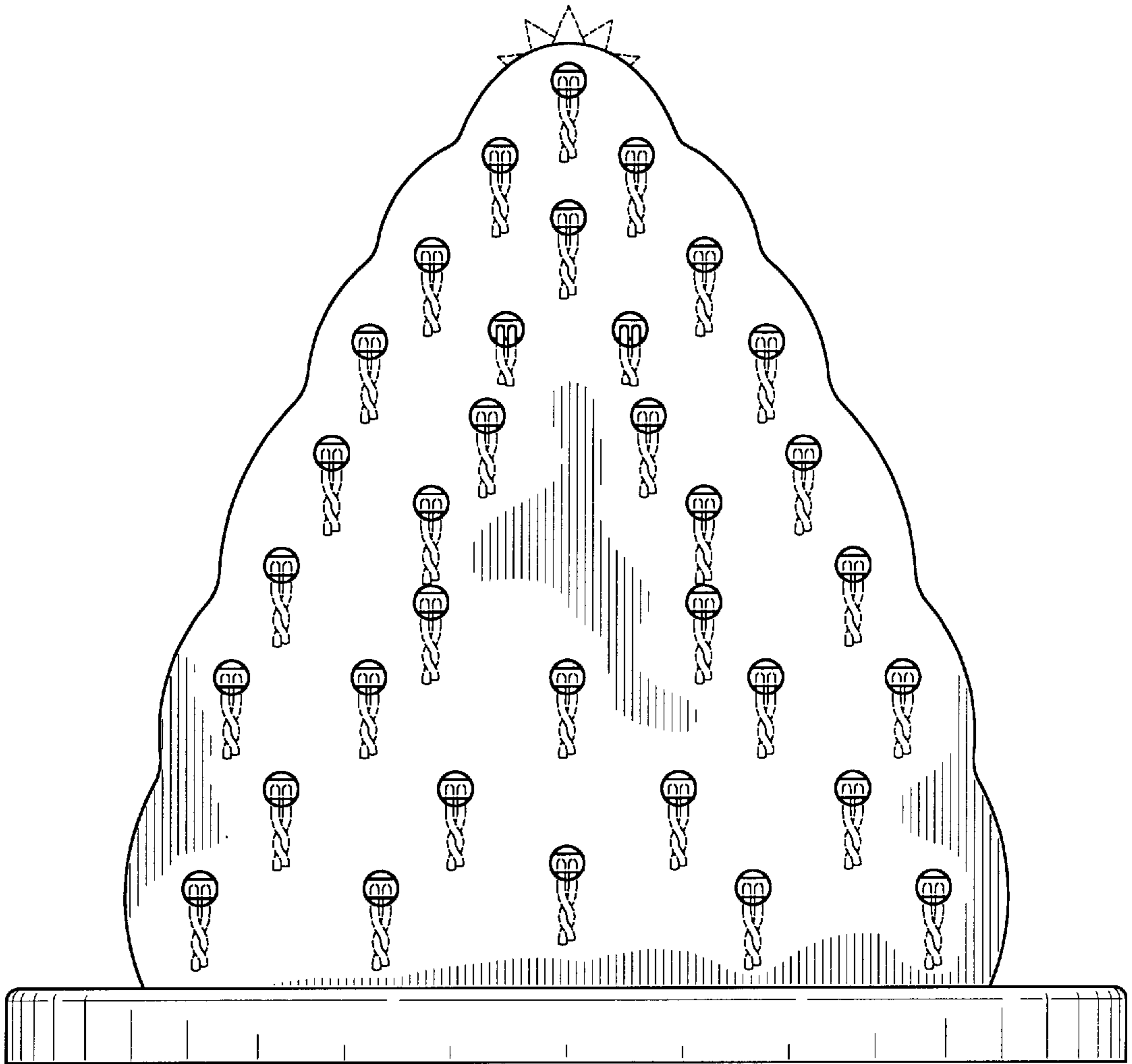

FIG-4

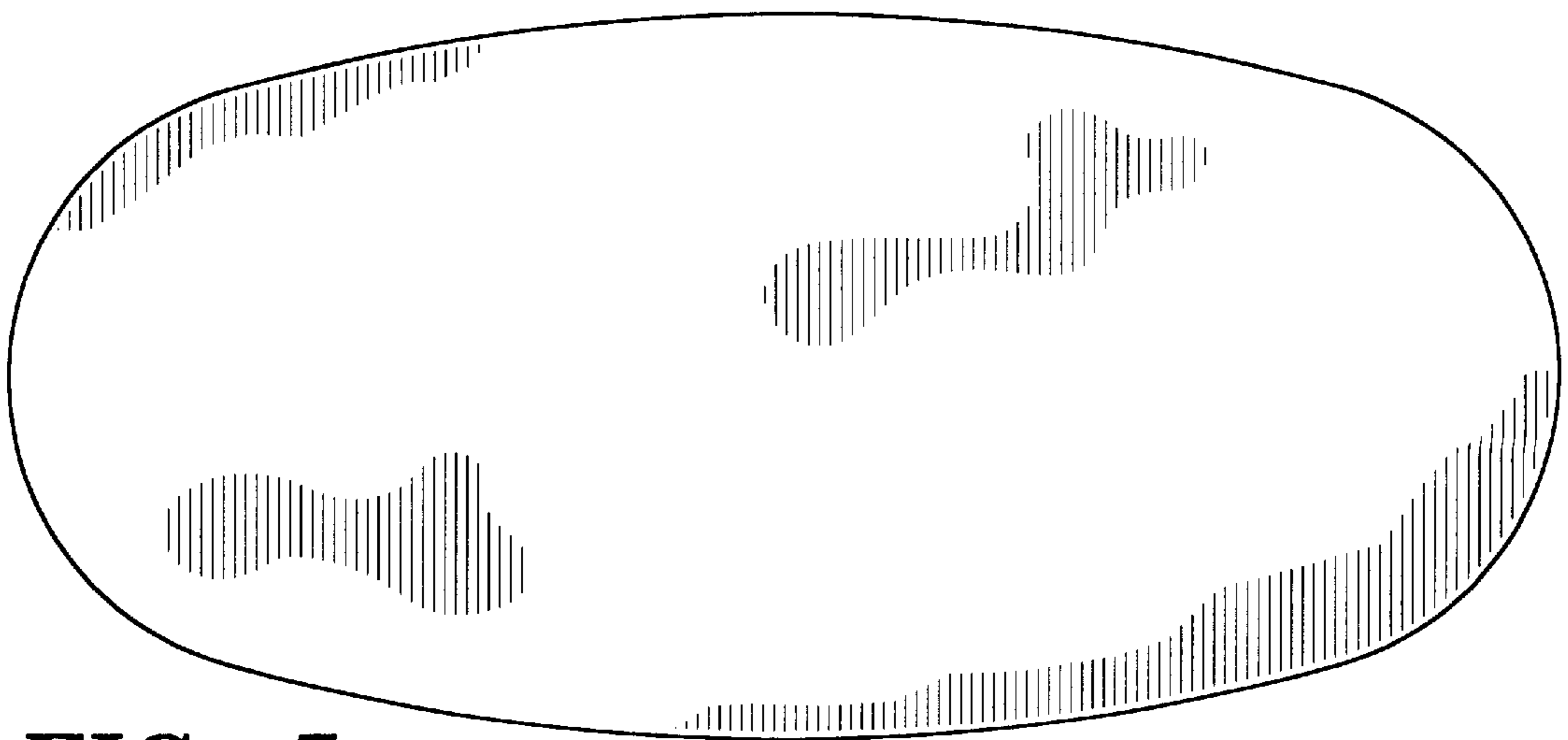

FIG-5

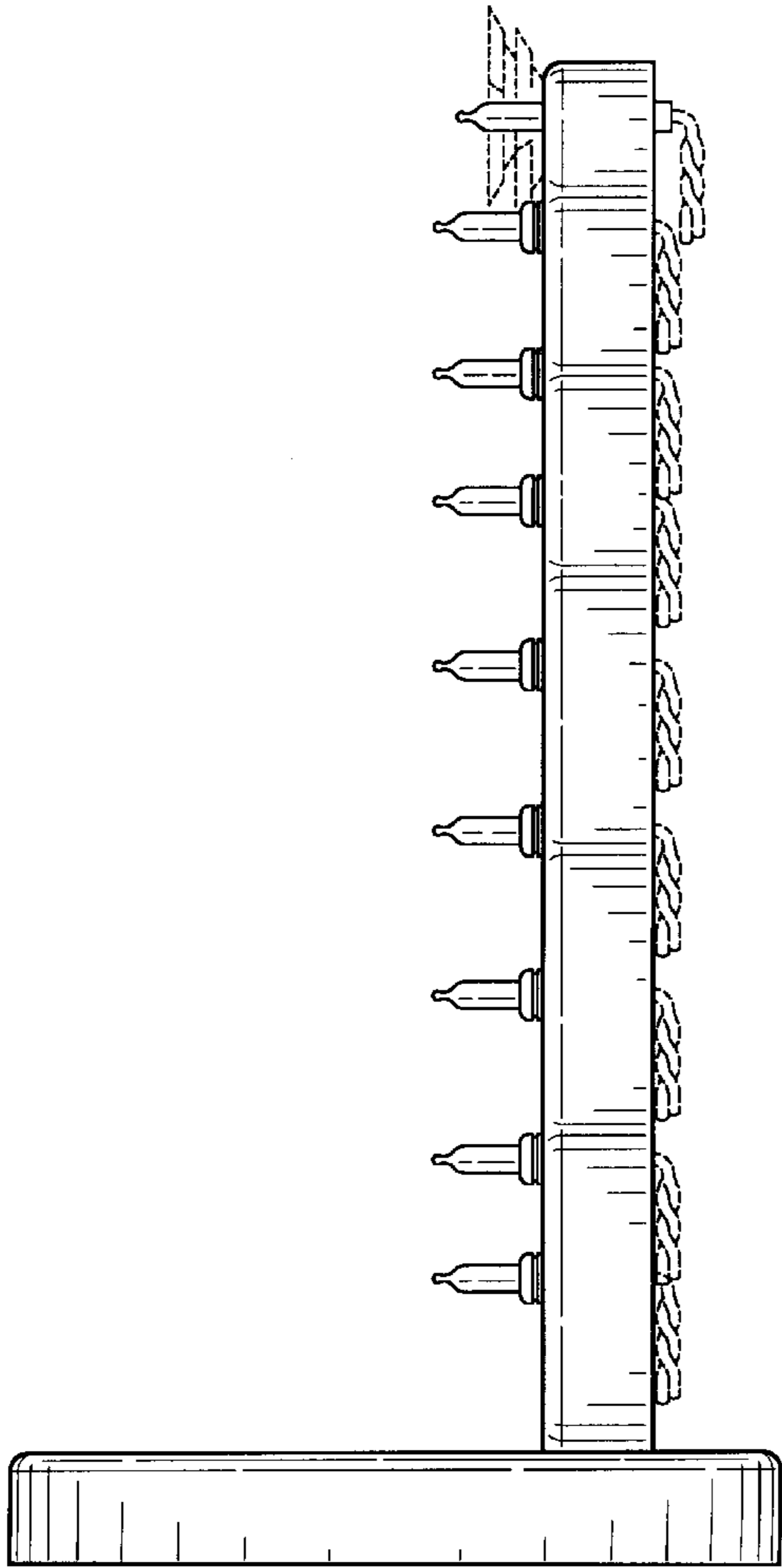

FIG-6

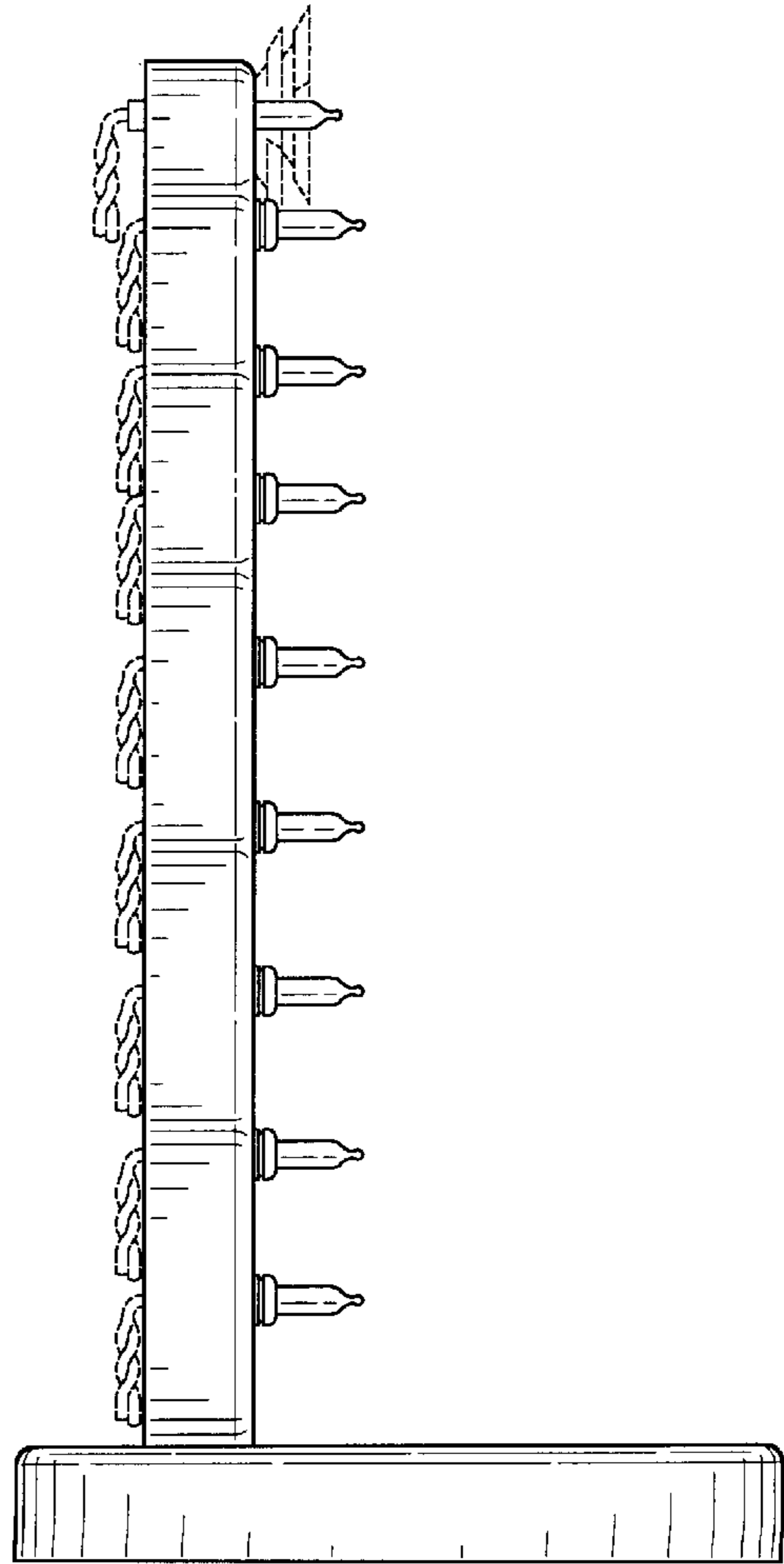

FIG-7