



US00D427892S

United States Patent [19]

[11] **Patent Number: Des. 427,892**

Walters-Dowding et al.

[45] **Date of Patent: ** Jul. 11, 2000**

[54] **WALL HOOK**

D. 206,661 1/1967 Burnbaum D8/367
D. 298,735 11/1988 Lakatos D8/367
D. 348,632 7/1994 Hollinger D8/373

[75] Inventors: **Andrea Walters-Dowding**, Dresden;
Lynn Lippert, Newark; **Sun Lacy**,
Newark; **Kent Shaeffer**, Newark, all of
Ohio; **Russell Gilbert**; **Shane**
Mathews, both of Mountain View, Ark.

Primary Examiner—Holly Baynham
Attorney, Agent, or Firm—Porter, Wright, Morris & Arthur
LLP

[73] Assignee: **The Longaberger Company**, Newark,
Ohio

[57] CLAIM

[**] Term: **14 Years**

The ornamental design for wall hook, as shown and
described.

[21] Appl. No.: **29/101,010**

DESCRIPTION

[22] Filed: **Feb. 22, 1999**

FIG. 1 is a perspective view of the wall hook showing our
new design;

[51] **LOC (7) Cl.** **08-05**

FIG. 2 is a front view thereof;

[52] **U.S. Cl.** **D8/367**

FIG. 3 is a top view thereof;

[58] **Field of Search** D8/367, 373; 248/301,
248/304, 215

FIG. 4 is a side view thereof, the opposite side being a mirror
image of this side;

[56] References Cited

FIG. 5 is a rear view thereof; and,

FIG. 6 is a bottom view thereof.

U.S. PATENT DOCUMENTS

D. 166,378 4/1952 Daugull D8/367

1 Claim, 2 Drawing Sheets

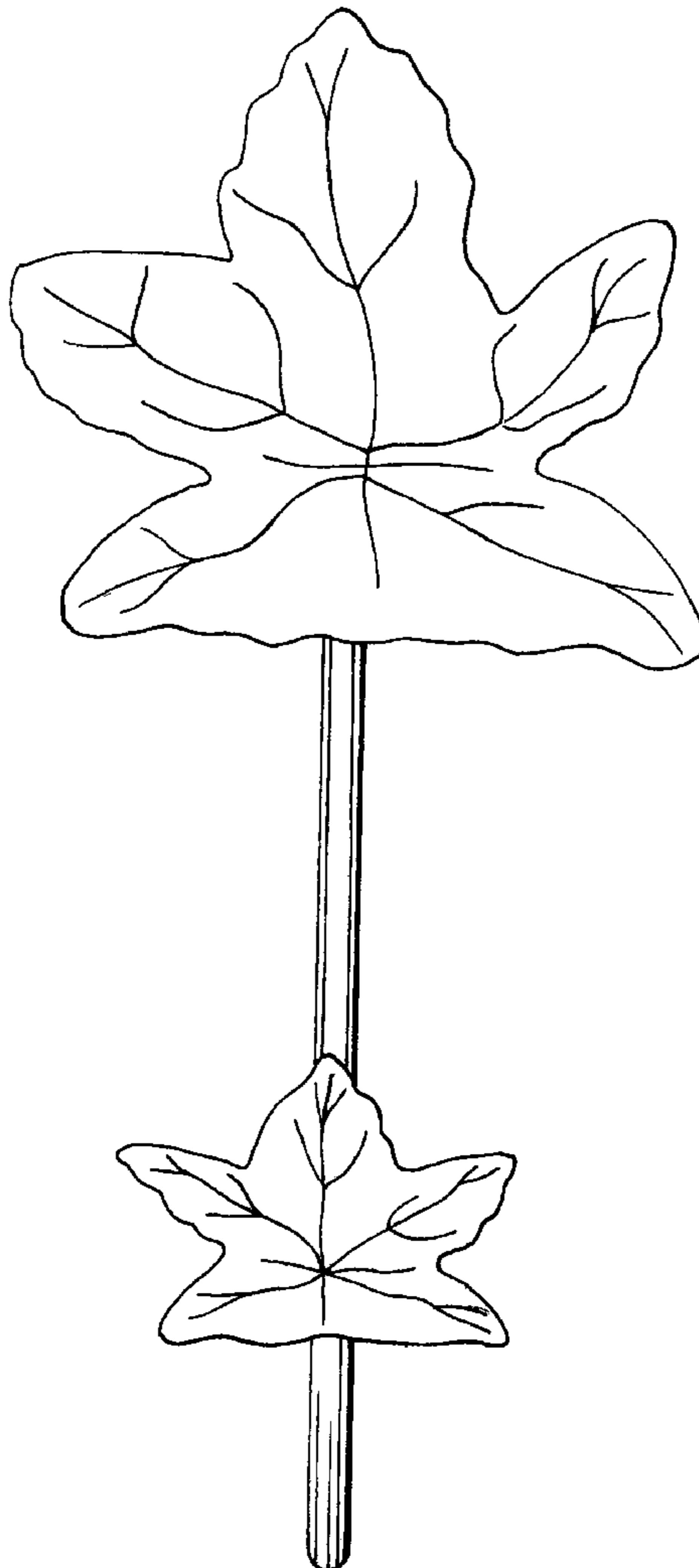

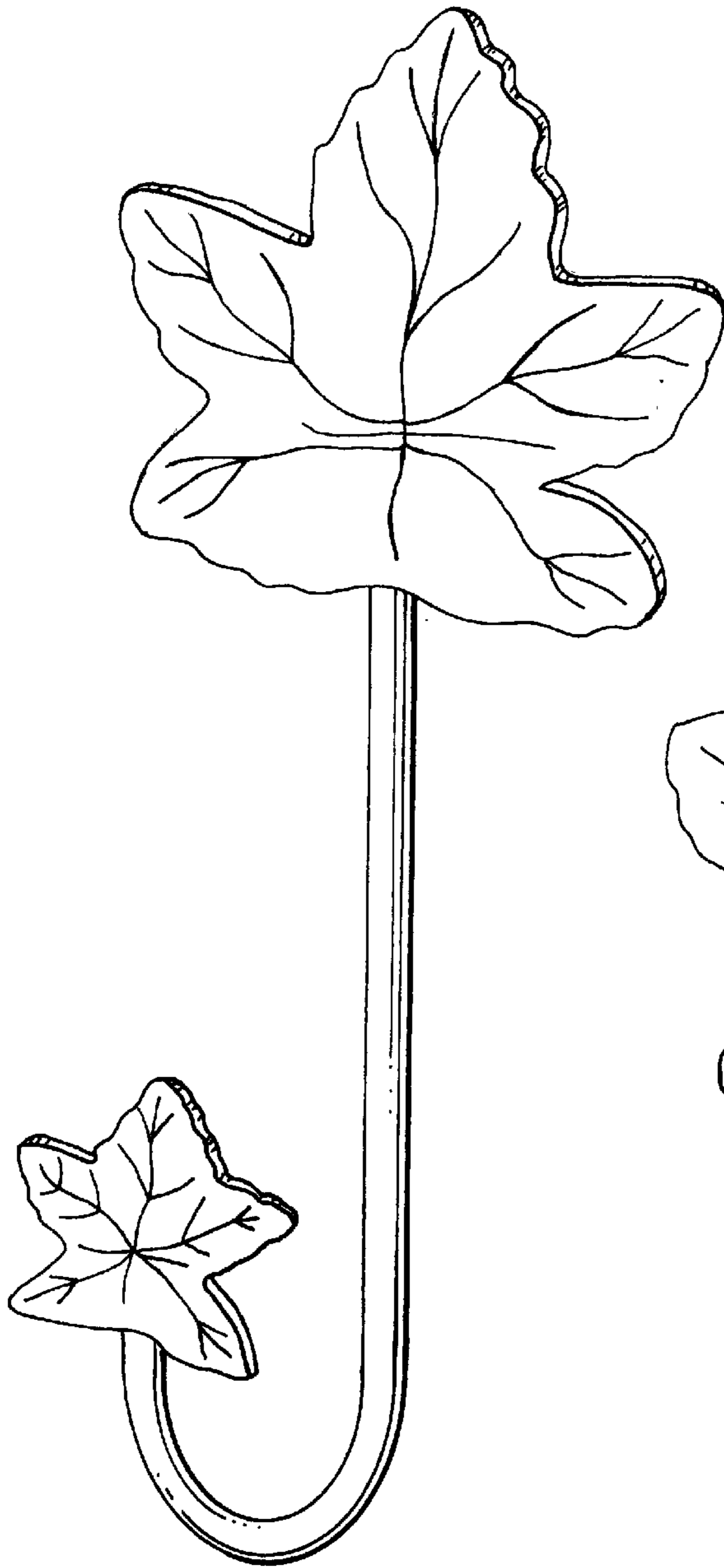

Fig. 1

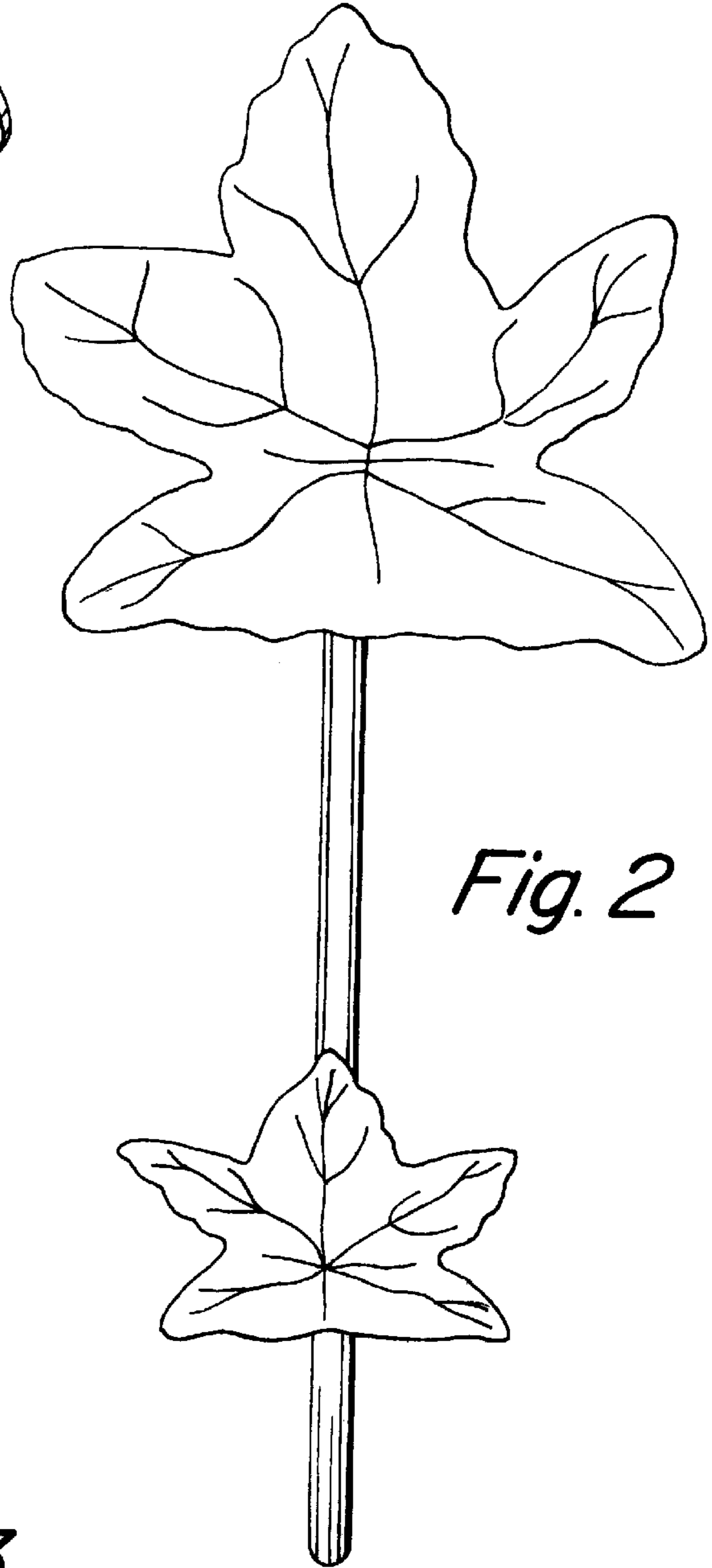

Fig. 2

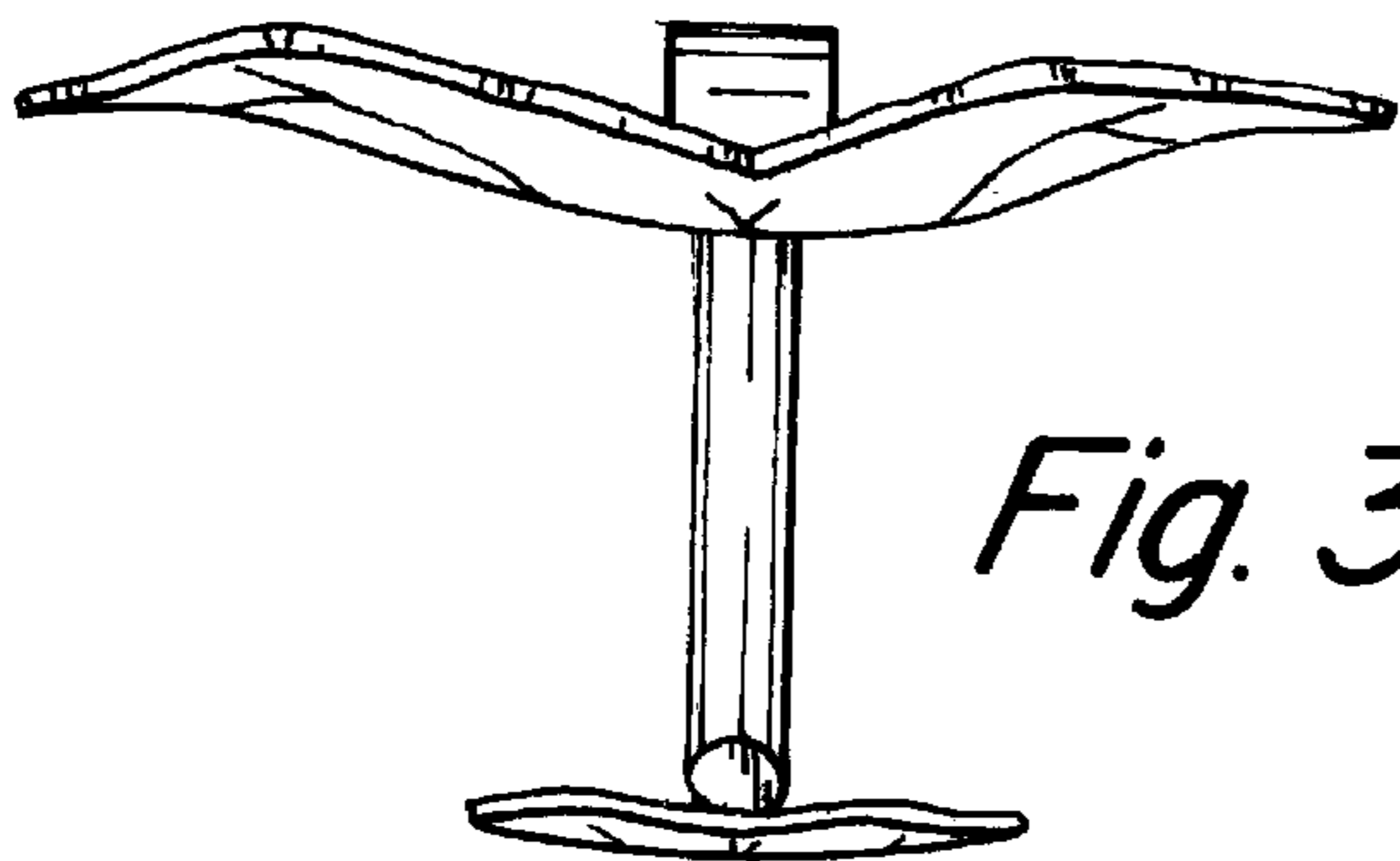

Fig. 3

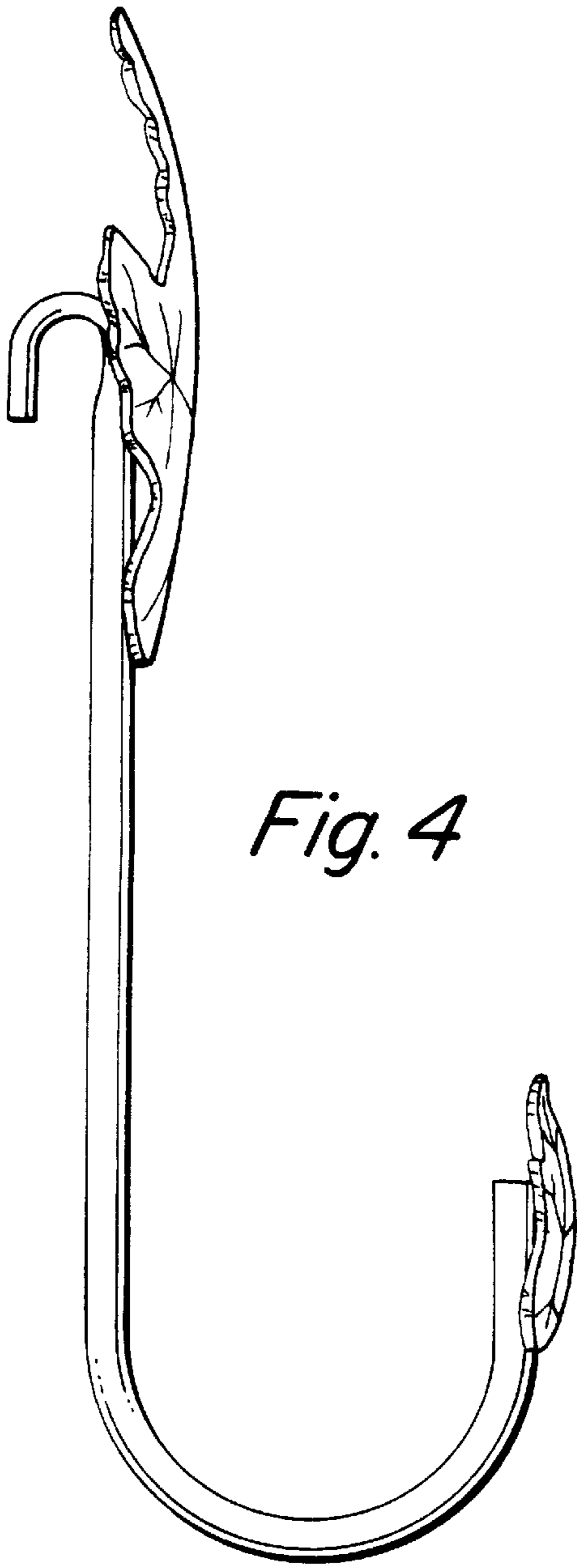

Fig. 4

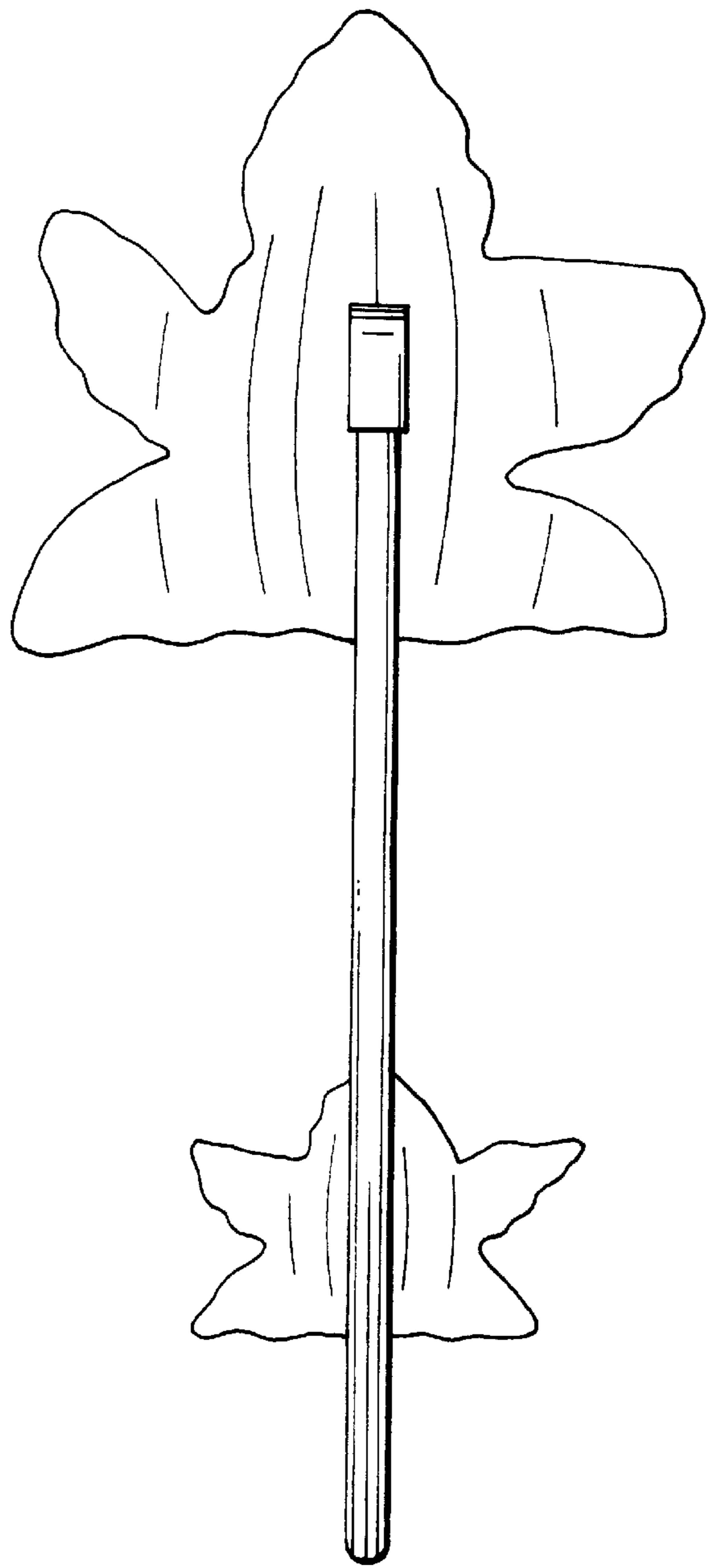

Fig. 5

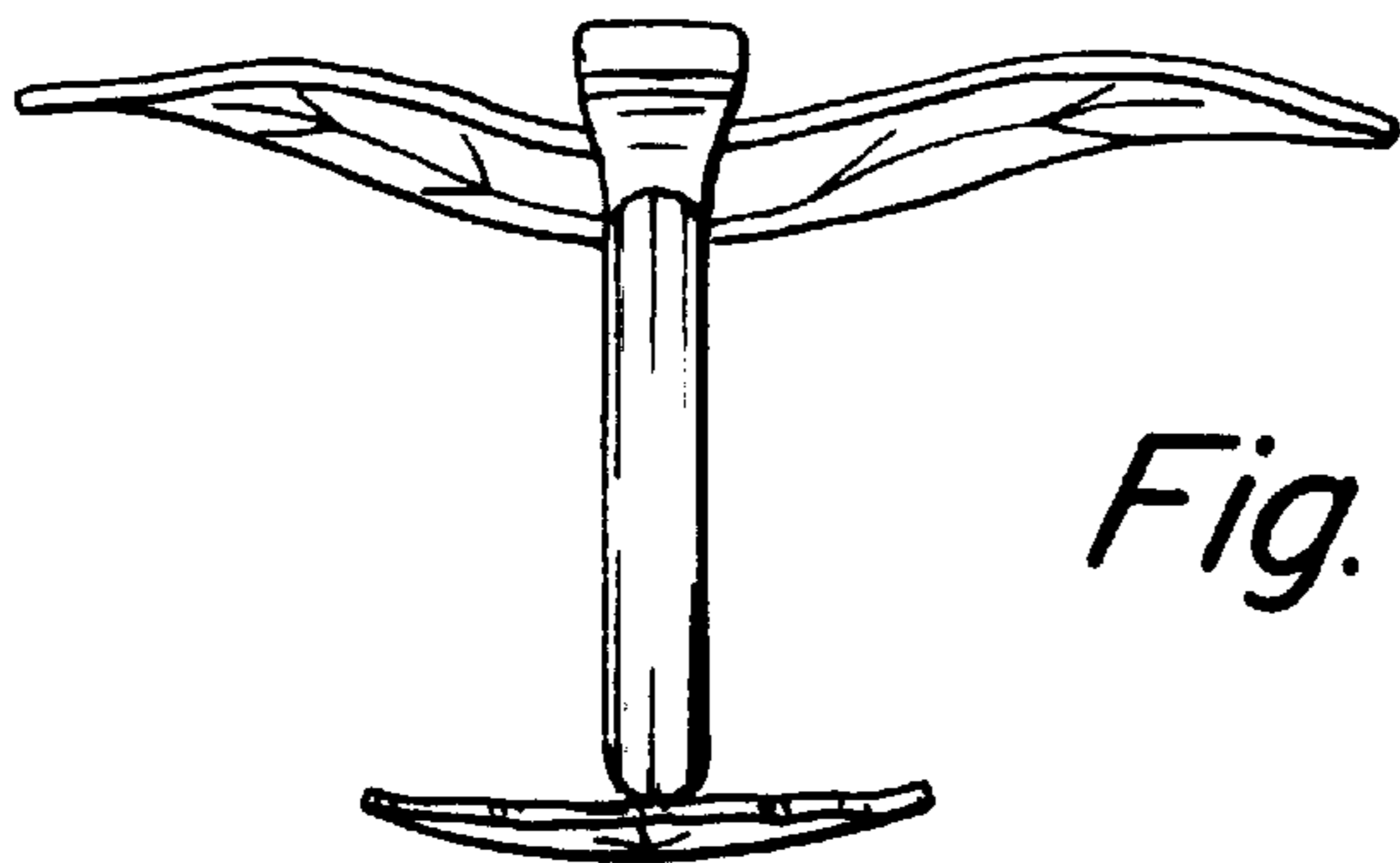

Fig. 6