



US00D427827S

United States Patent [19] Green

[11] **Patent Number: Des. 427,827**

[45] **Date of Patent: ** Jul. 11, 2000**

[54] **PAPER TOWEL HOLDER**

D. 416,413 11/1999 Green D6/522

[76] Inventor: **Jack M. Green**, 4535 Avenida Rio del Oro, Yorba Linda, Calif. 92886

Primary Examiner—Brian N. Vinson
Attorney, Agent, or Firm—Morland C. Fischer

[**] Term: **14 Years**

[57] **CLAIM**

[21] Appl. No.: **29/116,128**

The ornamental design for a paper towel holder, as shown and described.

[22] Filed: **Dec. 28, 1999**

DESCRIPTION

[51] **LOC (7) Cl.** **23-02**

[52] **U.S. Cl.** **D6/522**

[58] **Field of Search** D6/518-523; 242/570, 242/590, 598; 248/309.1; 312/348; D21/576, 578, 622

FIG. 1 is a perspective view of a paper towel holder which forms my new design, the broken lines in this and later figures being illustrative of a roll of paper towels and forming no part of the claimed design; FIG. 2 is a front elevational view thereof; FIG. 3 is a side elevational view thereof, this side and the opposite side being mirror images; FIG. 4 is a top plan view thereof; FIG. 5 is a rear elevational view thereof; and, FIG. 6 is a bottom plan view thereof.

[56] **References Cited**

U.S. PATENT DOCUMENTS

- D. 306,244 2/1990 King D6/522
- D. 327,598 7/1992 Emery D6/522
- D. 405,992 2/1999 Lee et al. D6/522

1 Claim, 2 Drawing Sheets

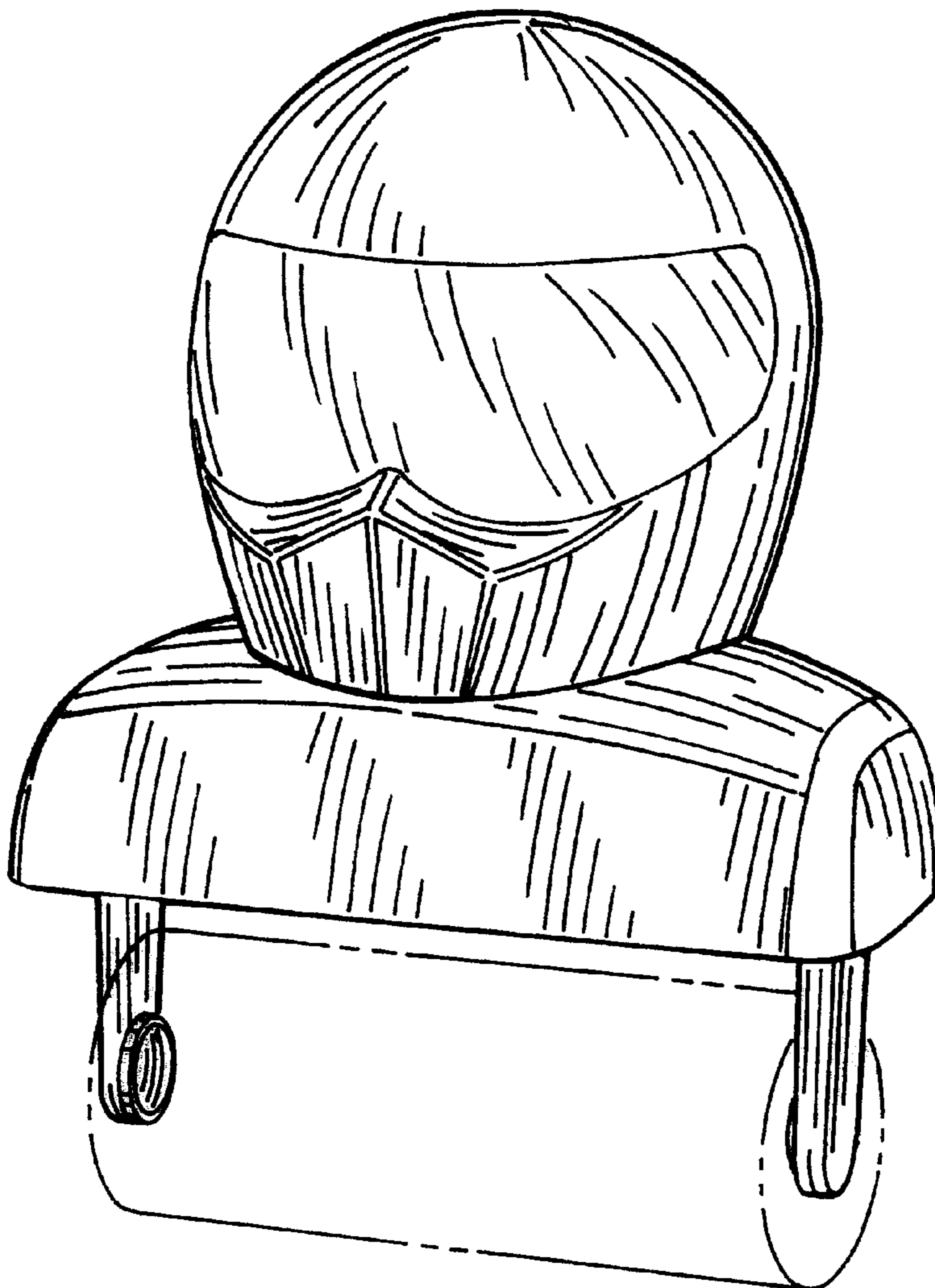

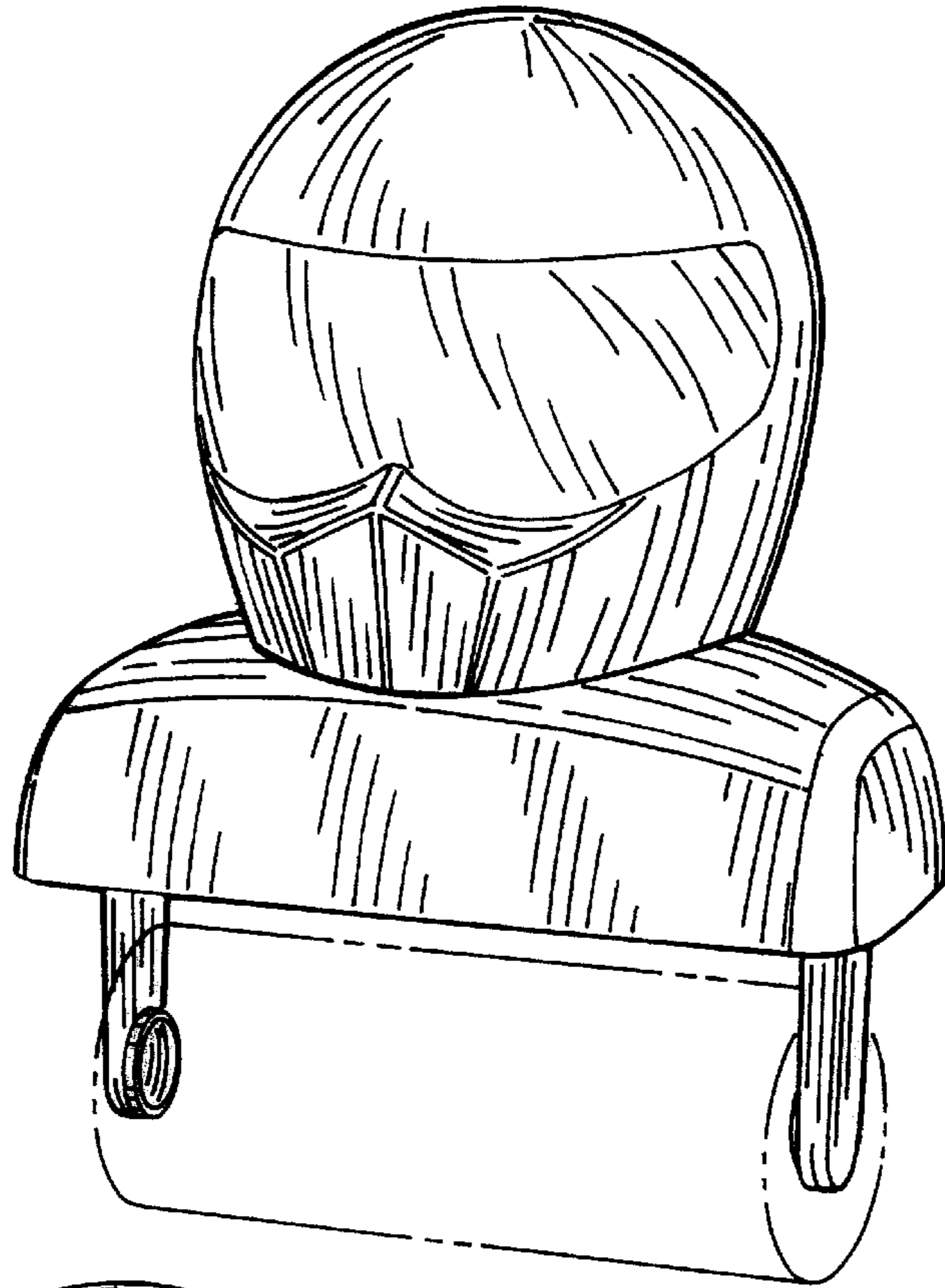

FIG. 1

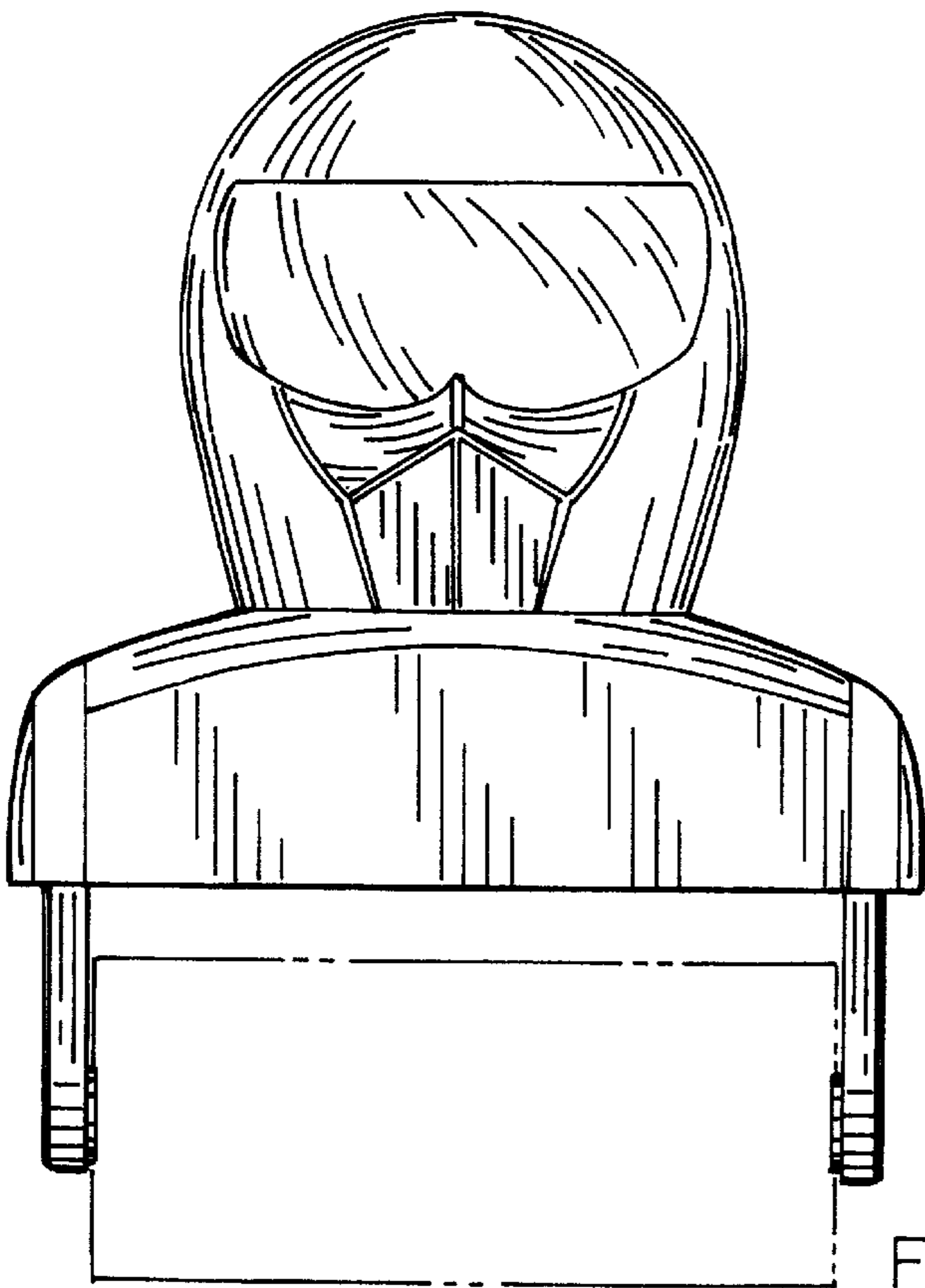

FIG. 2

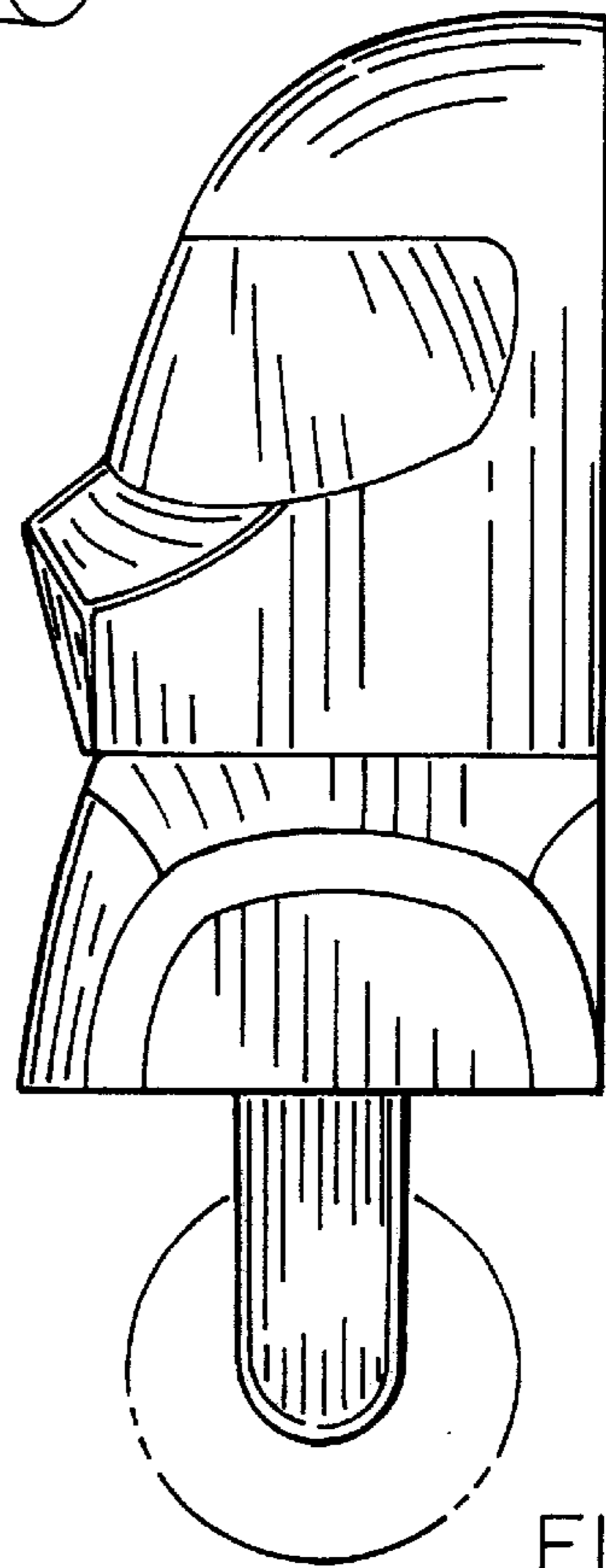

FIG. 3

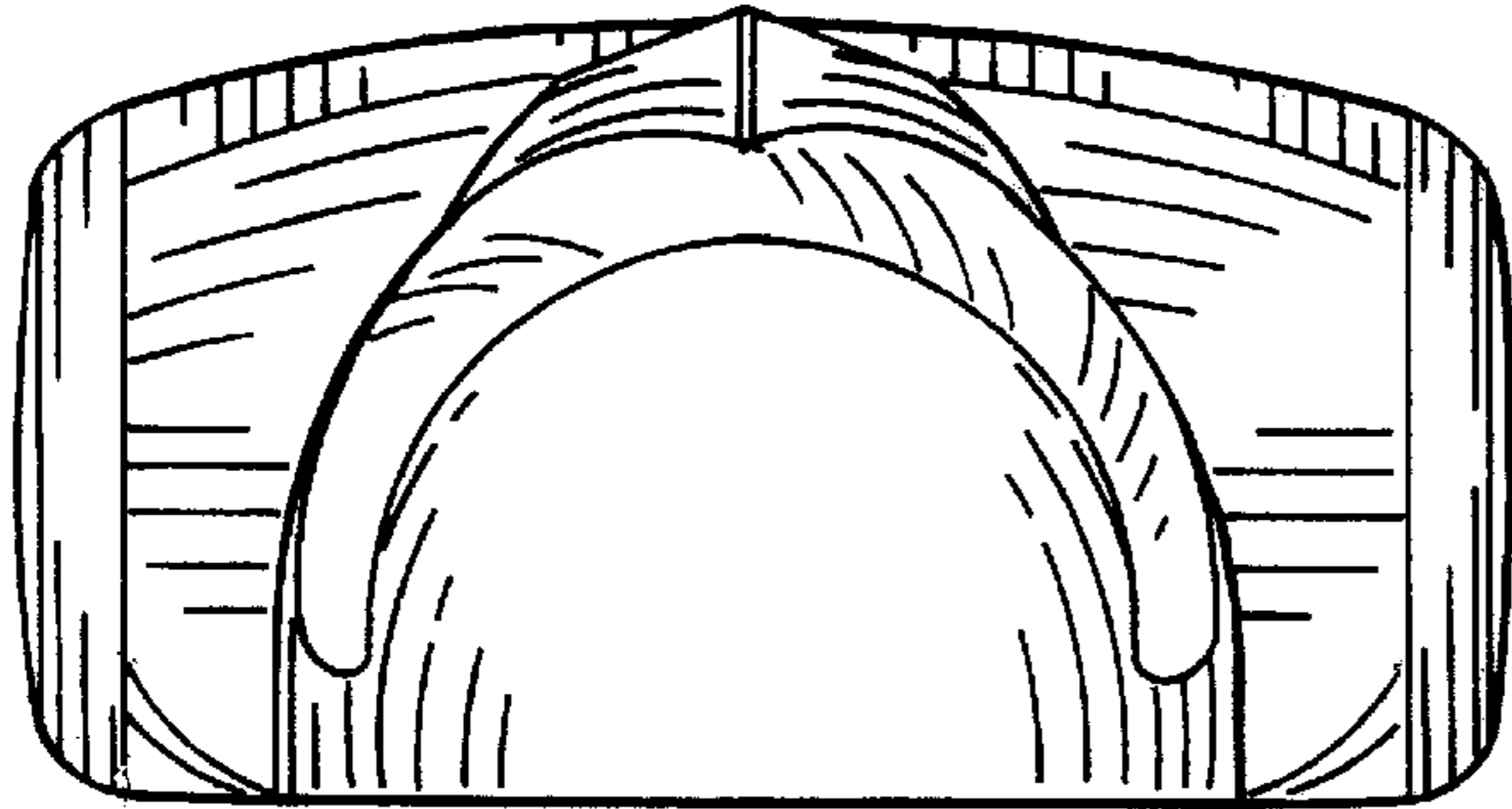

FIG. 4

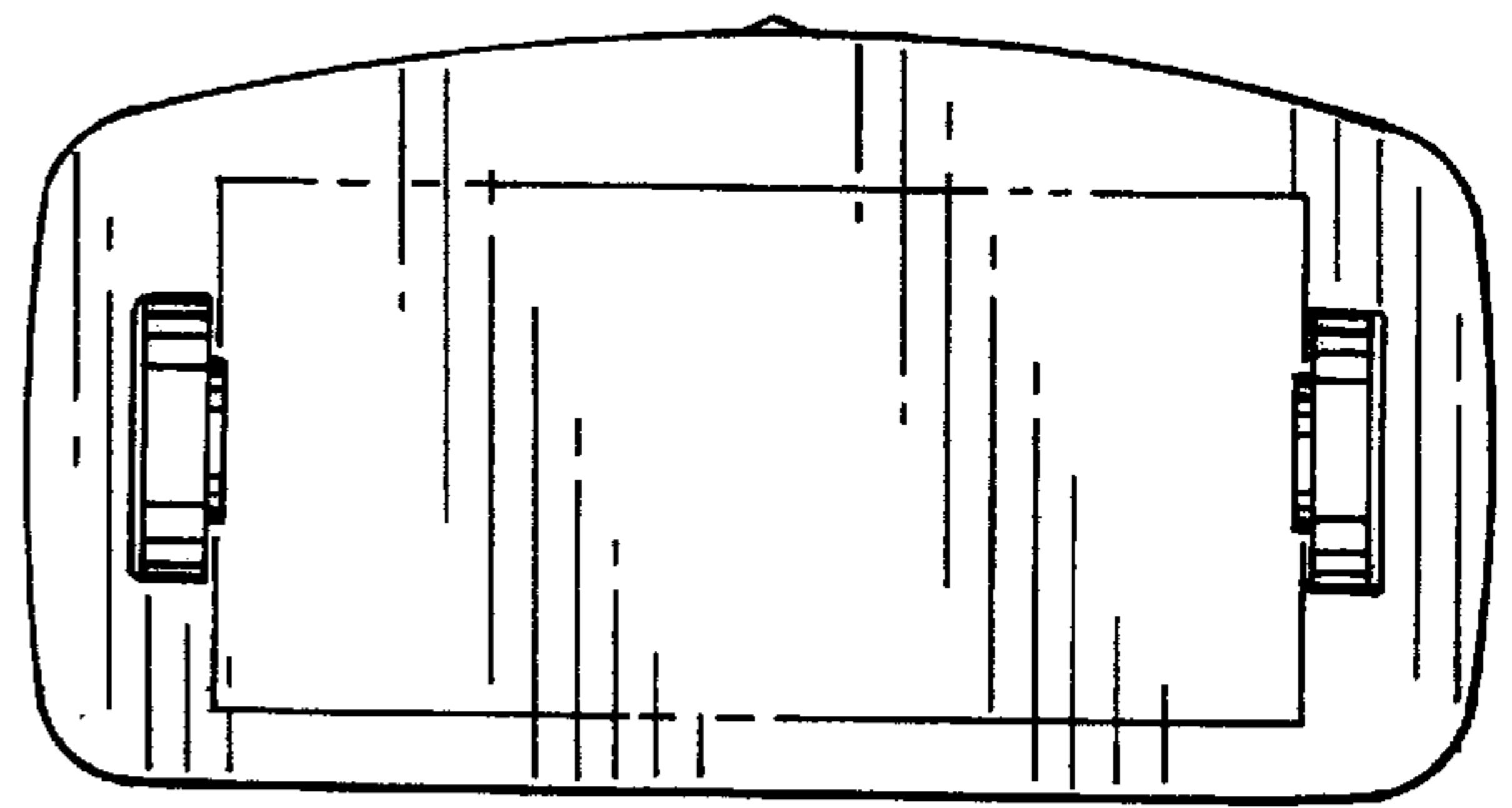

FIG. 5

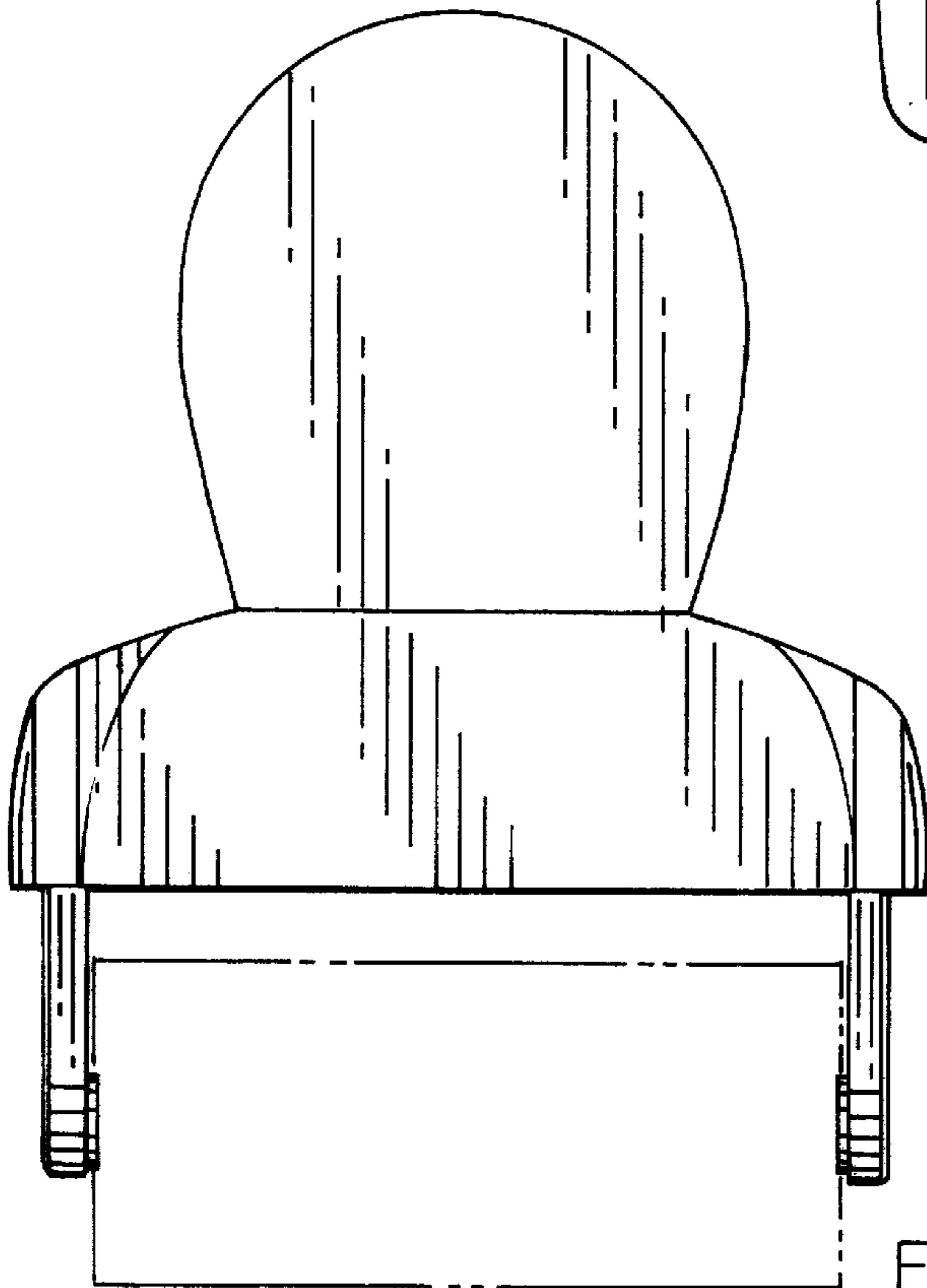

FIG. 6