



US00D427661S

United States Patent [19]

Haverstraw et al.

[11] Patent Number: Des. 427,661

[45] Date of Patent: ** Jul. 4, 2000

[54] WALL-MOUNT SHOWER HEAD WITH FACE PLATE

[75] Inventors: Jay Haverstraw, Fort Collins, Colo.; Andrew Serbinski, Annandale, N.J.; Mirzat Koc, Brooklyn; Ragnhild Haugum, New York, both of N.Y.

[73] Assignee: Teledyne Industries, Inc., Fort Collins, Colo.

[**] Term: 14 Years

[21] Appl. No.: 29/092,746

[22] Filed: Aug. 26, 1998

[51] LOC (7) Cl. 23-01

[52] U.S. Cl. D23/229

[58] Field of Search D23/213, 214, D23/223, 226, 229, 230; 239/394, 460-462, 556, 560

[56] References Cited

U.S. PATENT DOCUMENTS

- D. 261,417 10/1981 Klose D23/213
- D. 375,541 11/1996 Michaluk D23/213
- D. 385,616 10/1997 Dow et al. D23/229

D. 395,074 6/1998 Neilbrook D23/229

Primary Examiner—Robin V. Taylor
Attorney, Agent, or Firm—Holland & Hart LLP

[57] CLAIM

The ornamental design for a wall-mount shower head with face plate, as shown and described.

DESCRIPTION

FIG. 1 is a front perspective view of a wall-mount shower head with face plate showing our new design;
 FIG. 2 is a front elevational view thereof;
 FIG. 3 is a left side elevational view thereof, with the right side elevational view being a mirror image thereof;
 FIG. 4 is a top plan view thereof;
 FIG. 6 is a back elevational view thereof;
 FIG. 7 is a front perspective view of an alternative embodiment of the wall-mount shower head with face plate showing our new design;
 FIG. 8 is a front elevational view thereof;
 FIG. 9 is a left side elevational view thereof, with the right side elevational view being a mirror image thereof;
 FIG. 10 is a top plan view thereof;
 FIG. 11 is a bottom plan view thereof; and,
 FIG. 12 is a back elevational view thereof.

1 Claim, 6 Drawing Sheets

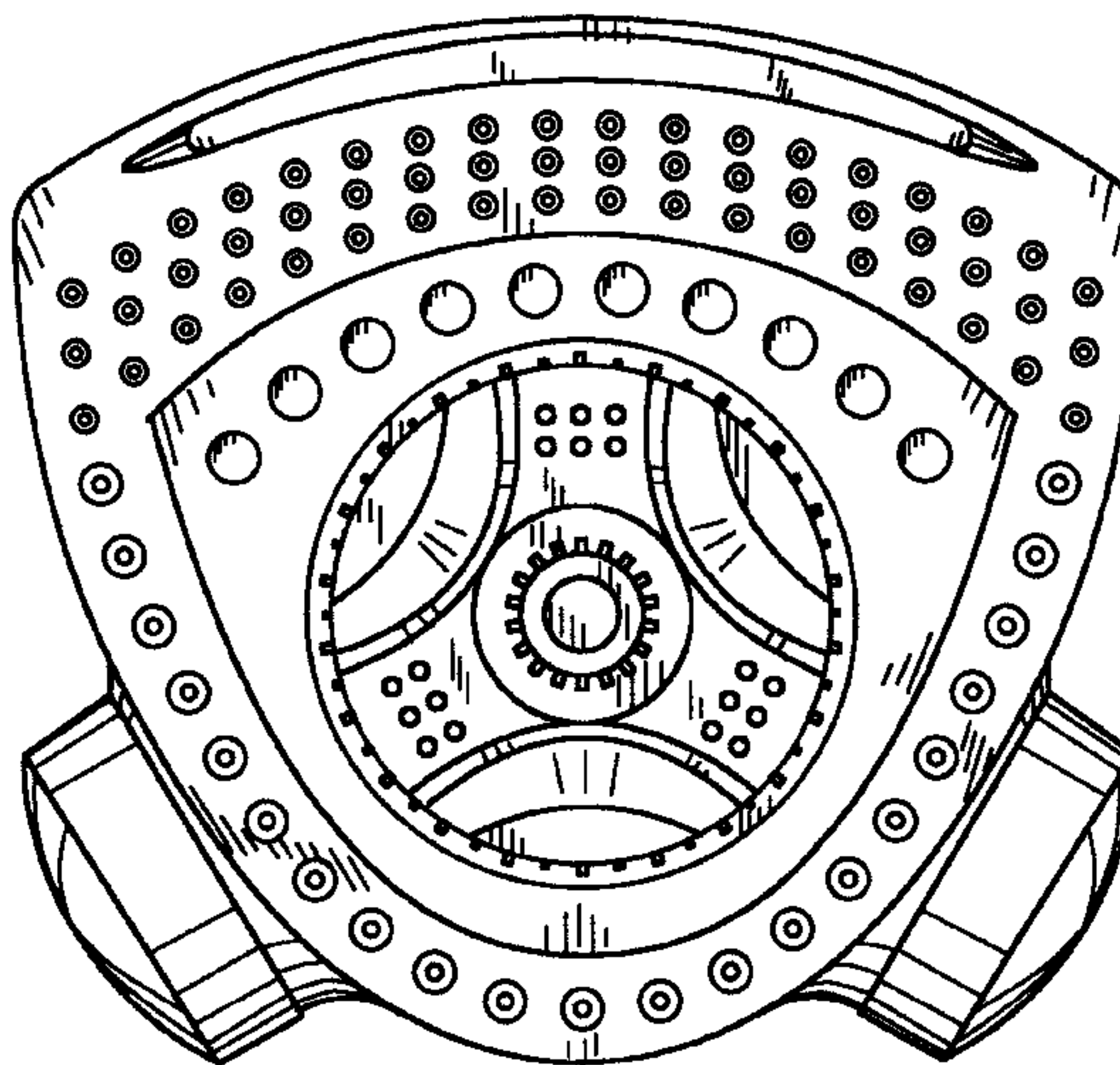
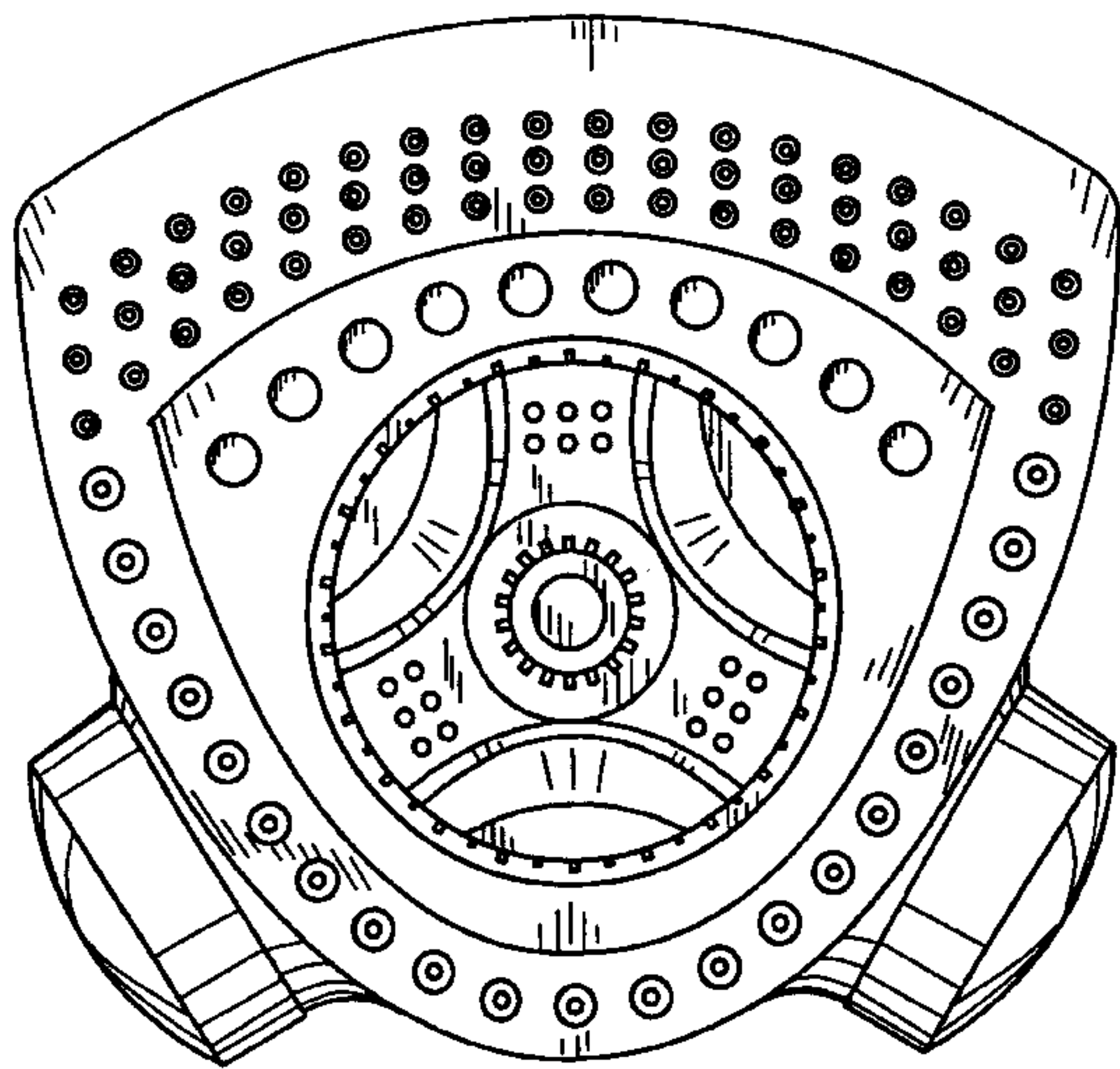

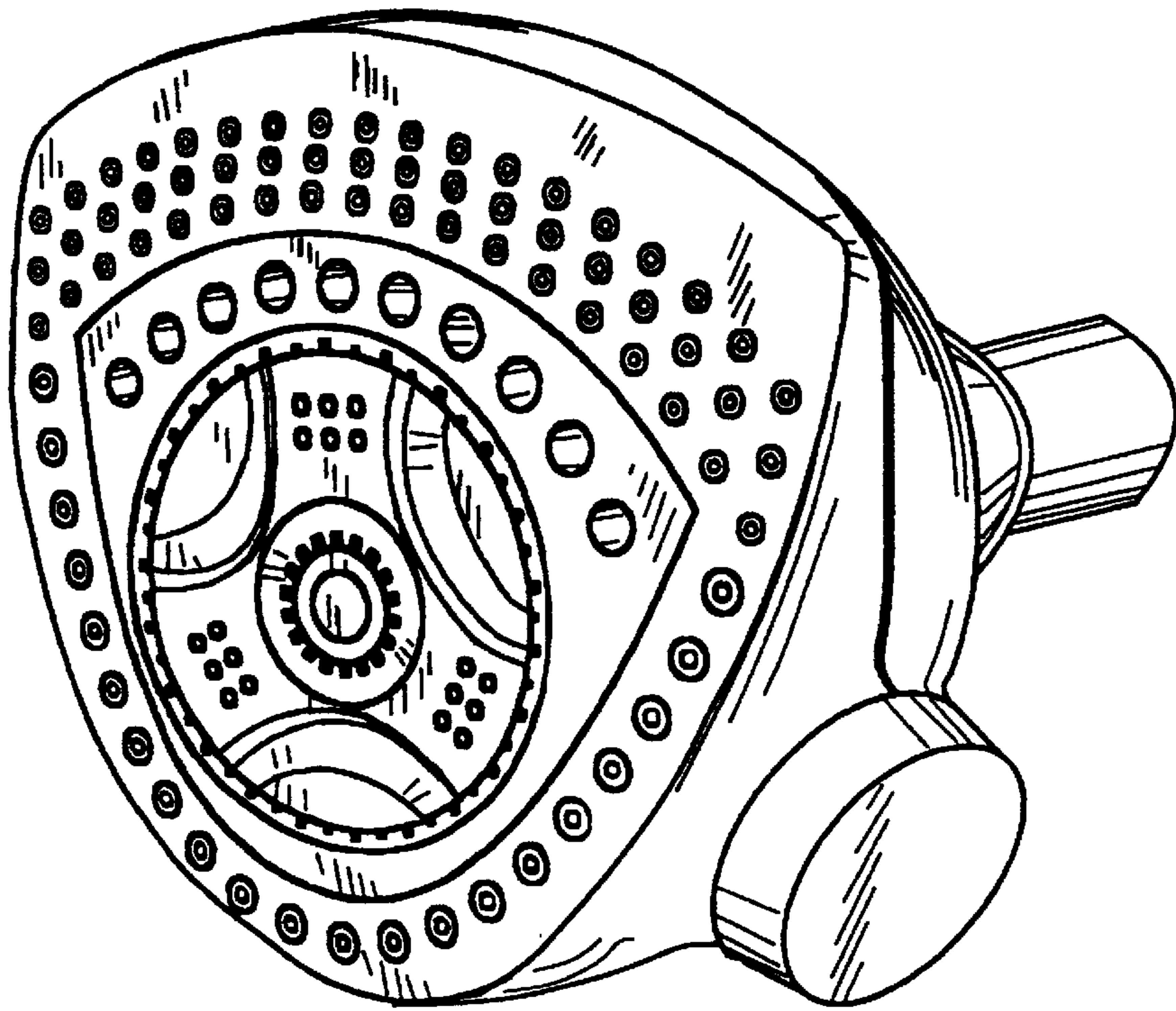

Fig. 1

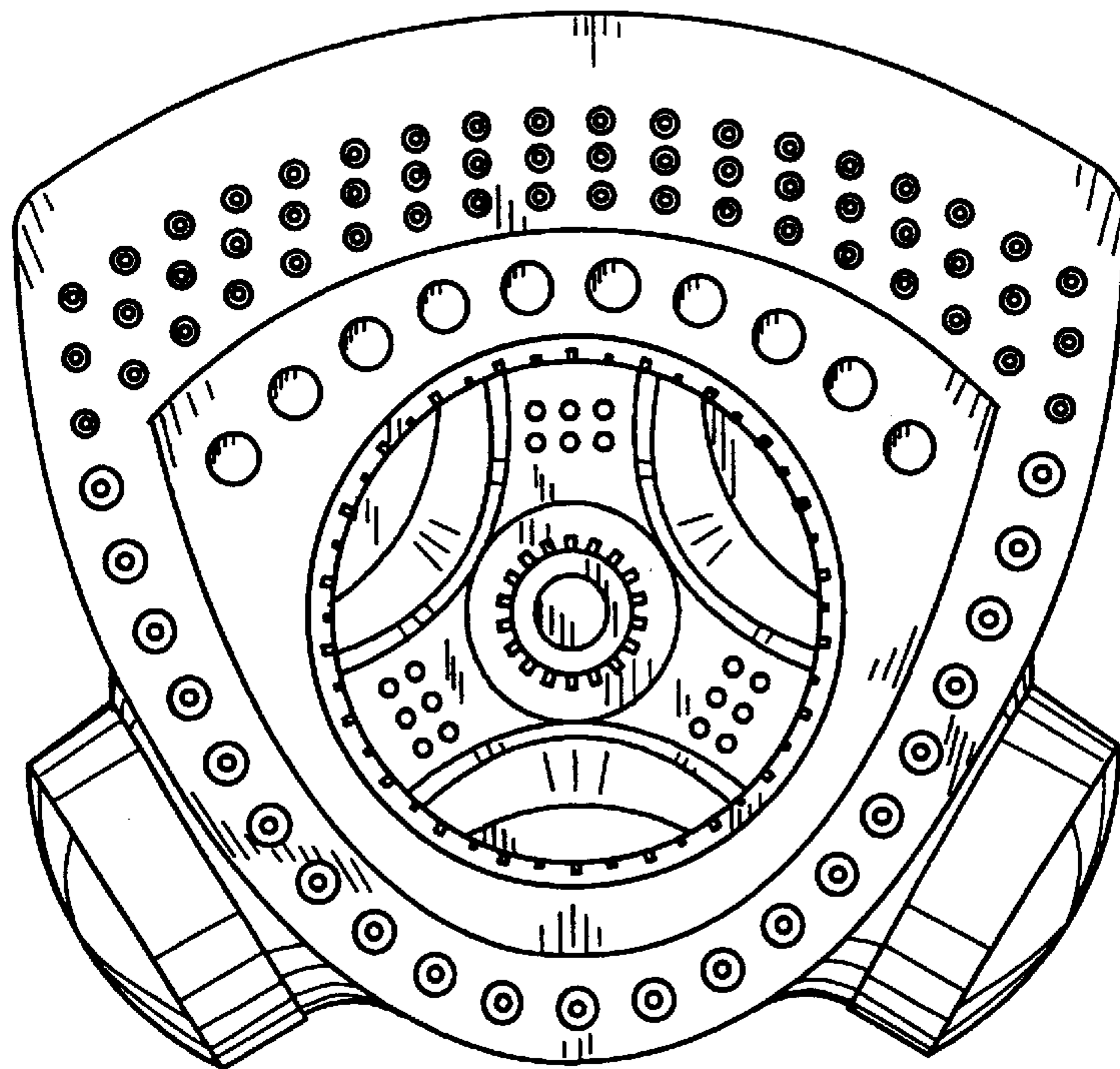

Fig. 2

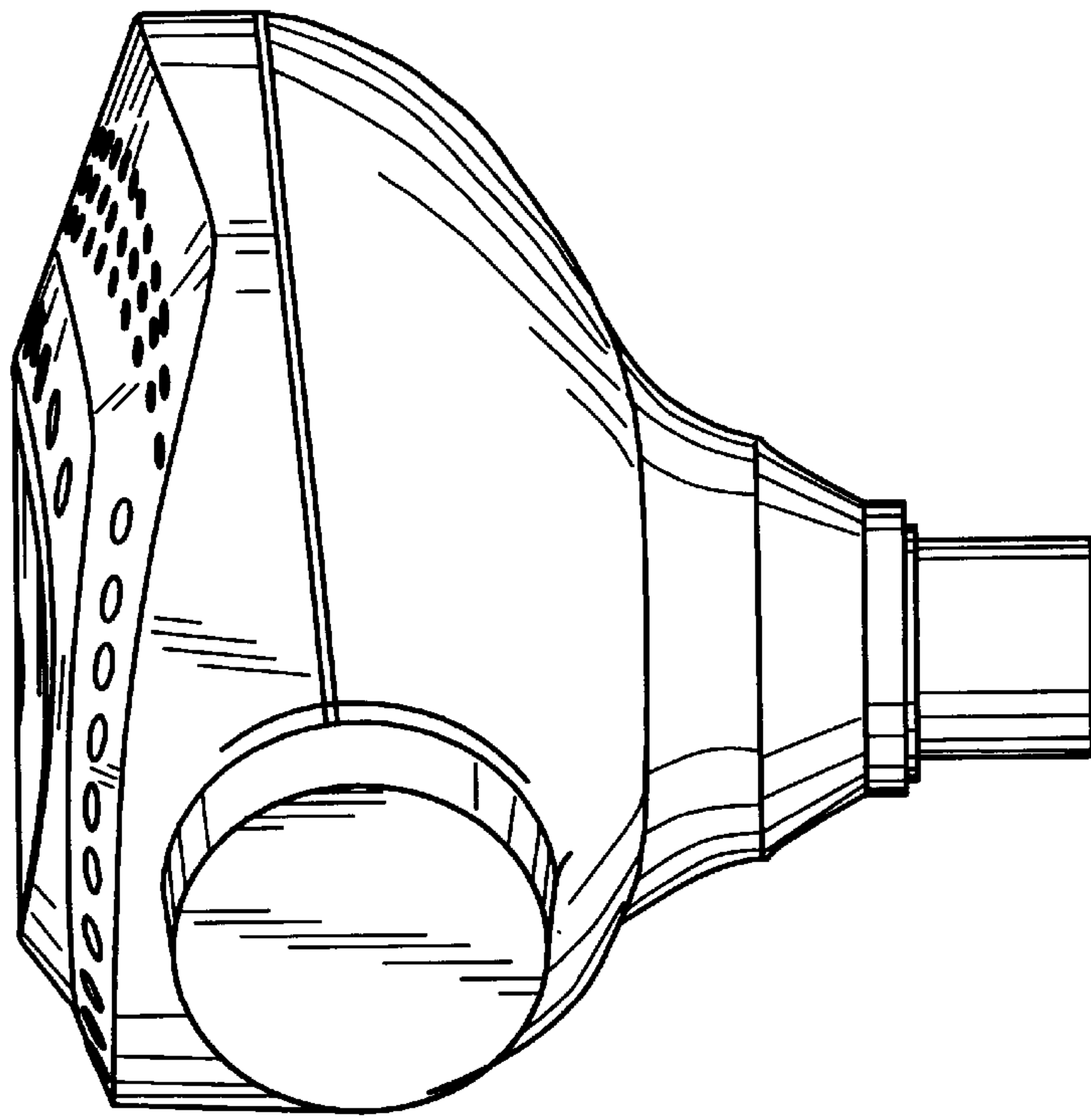

Fig. 3

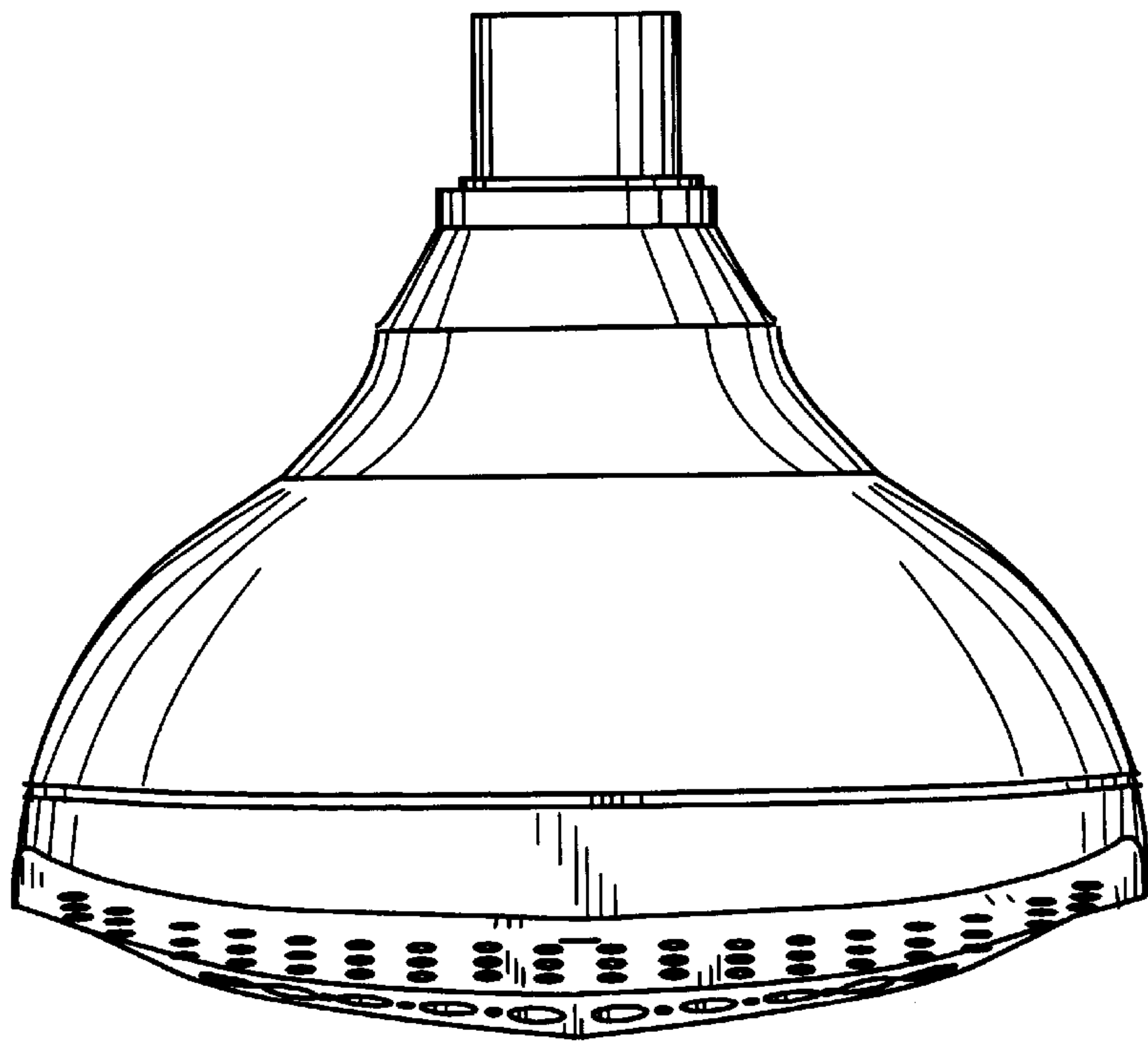

Fig. 4

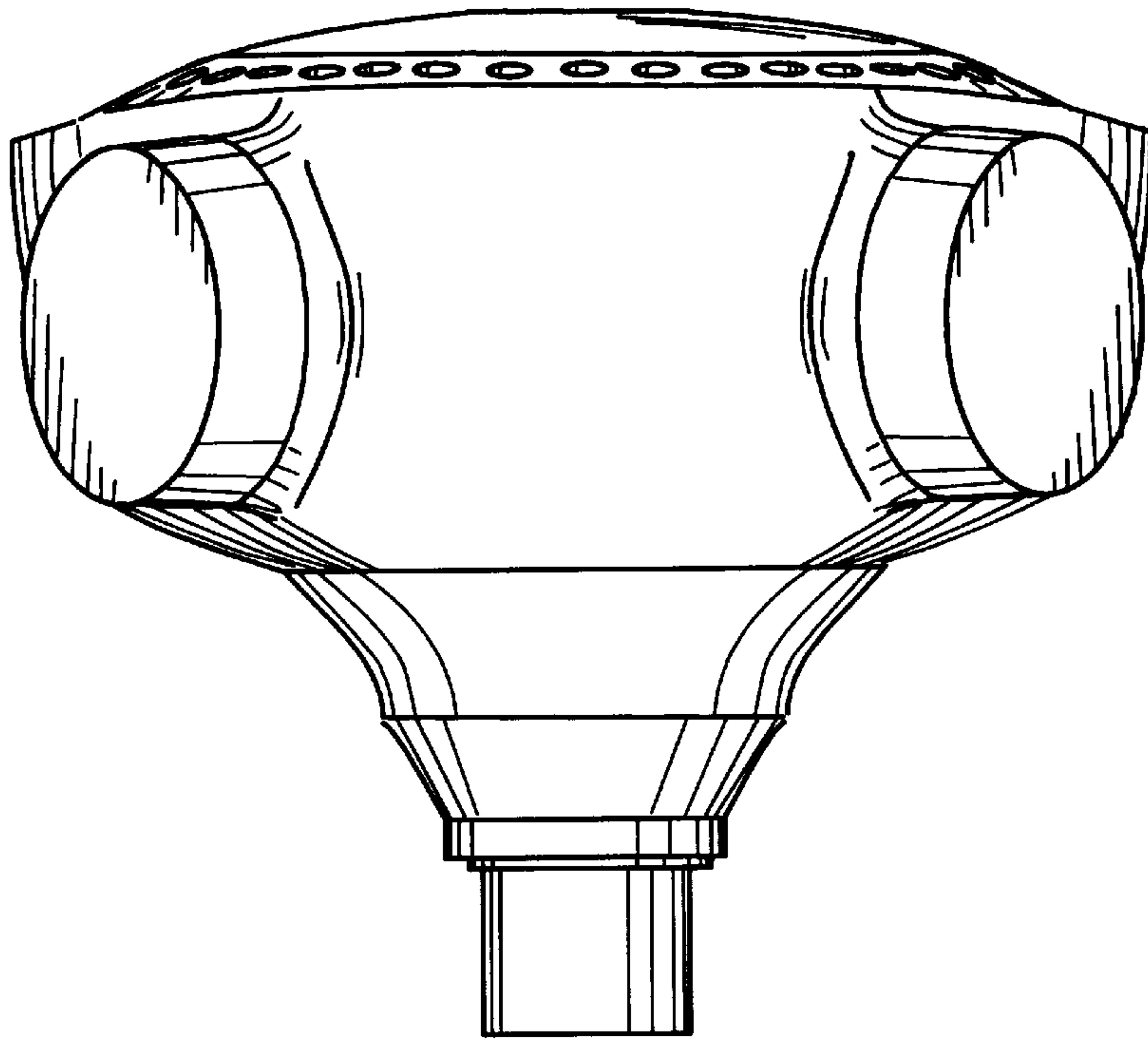

Fig. 5

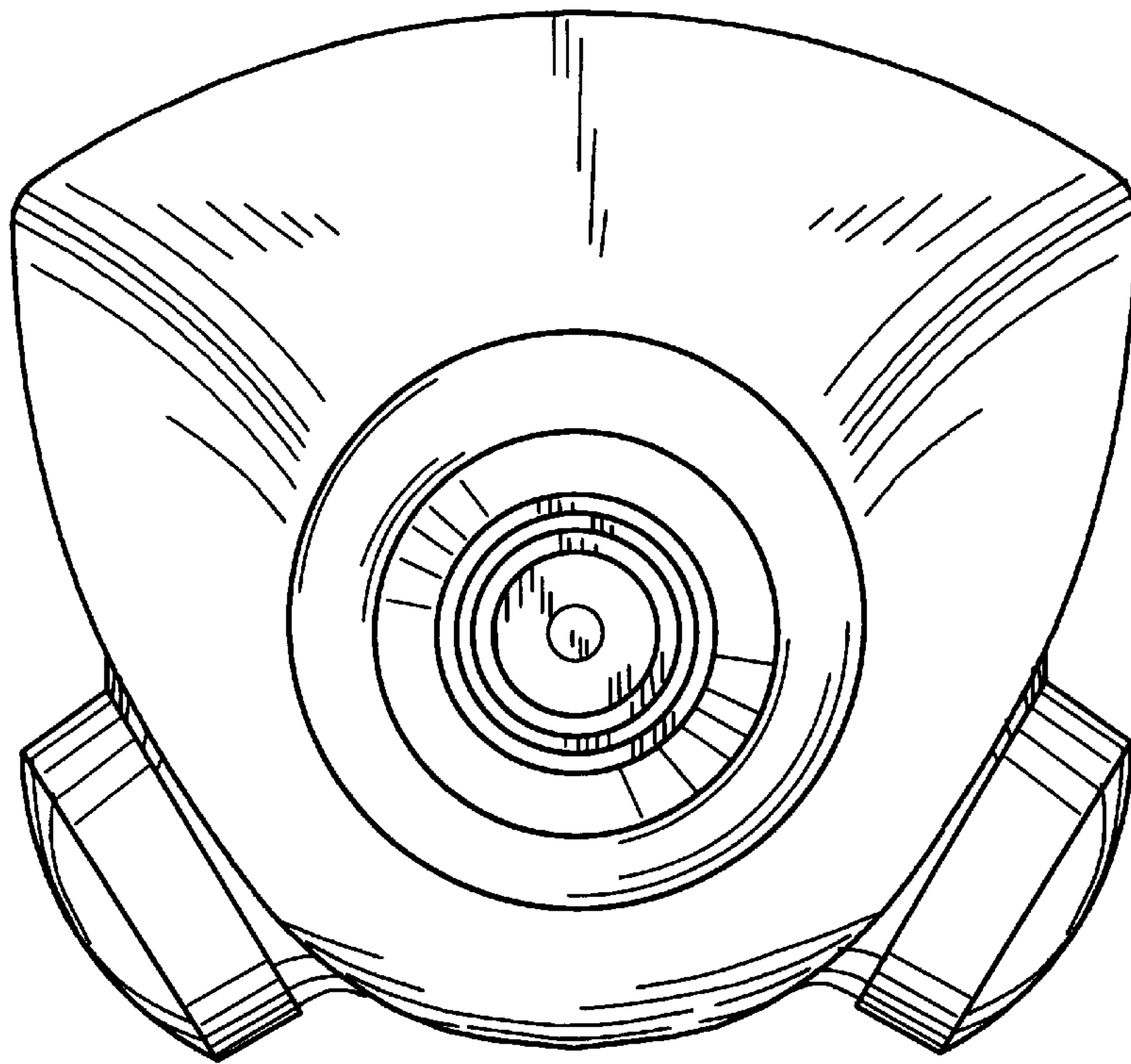

Fig. 6

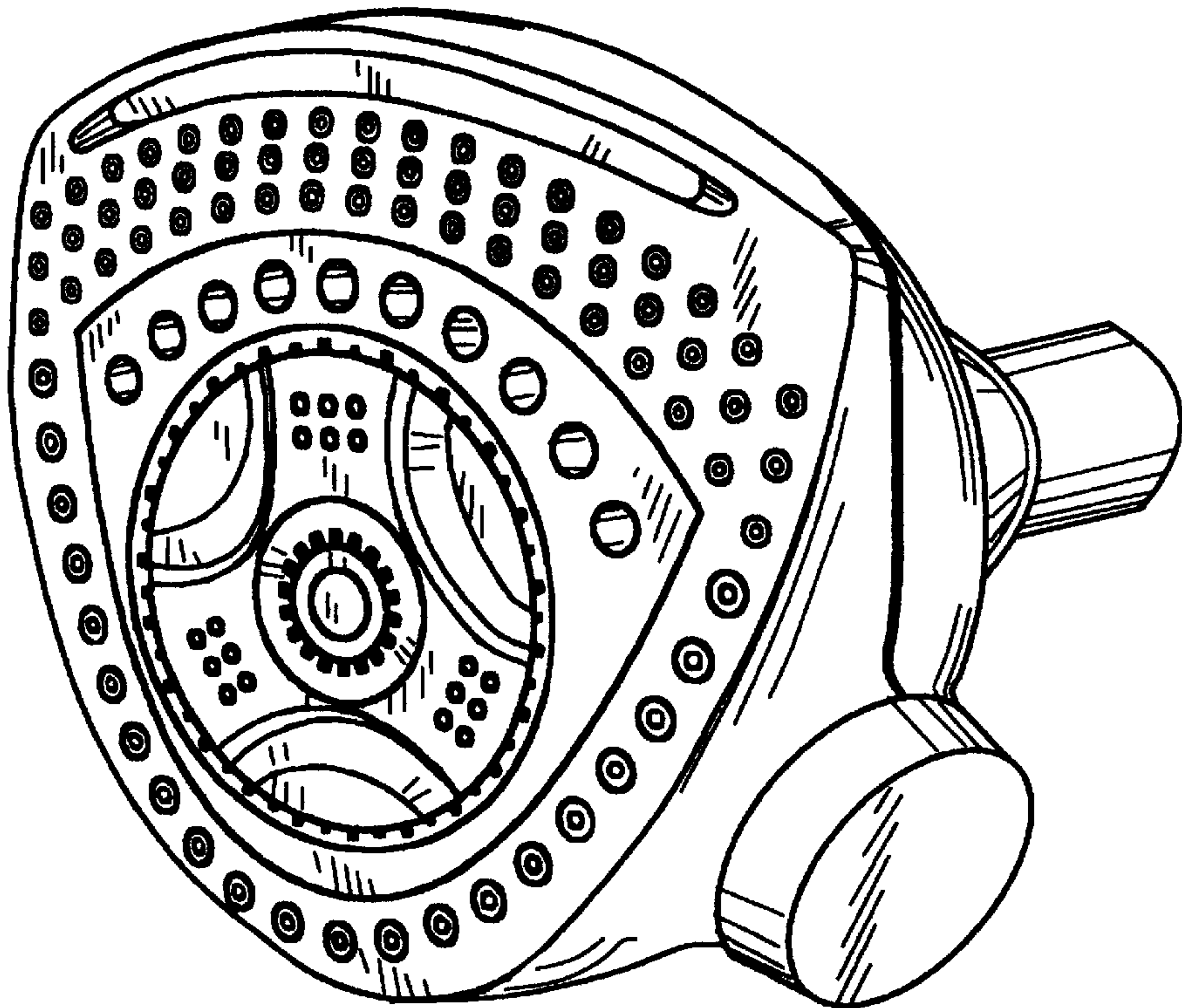

Fig. 7

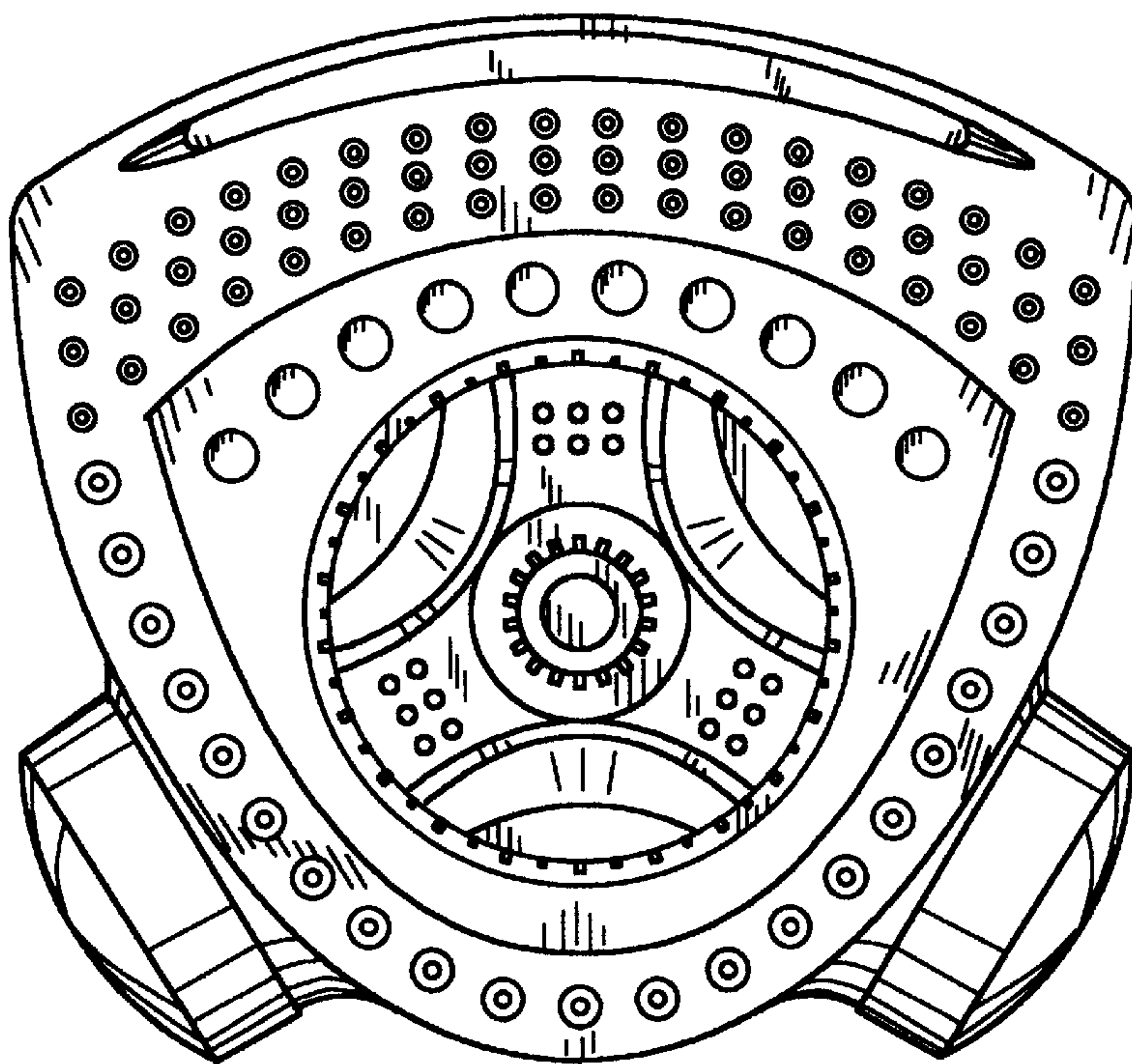

Fig. 8

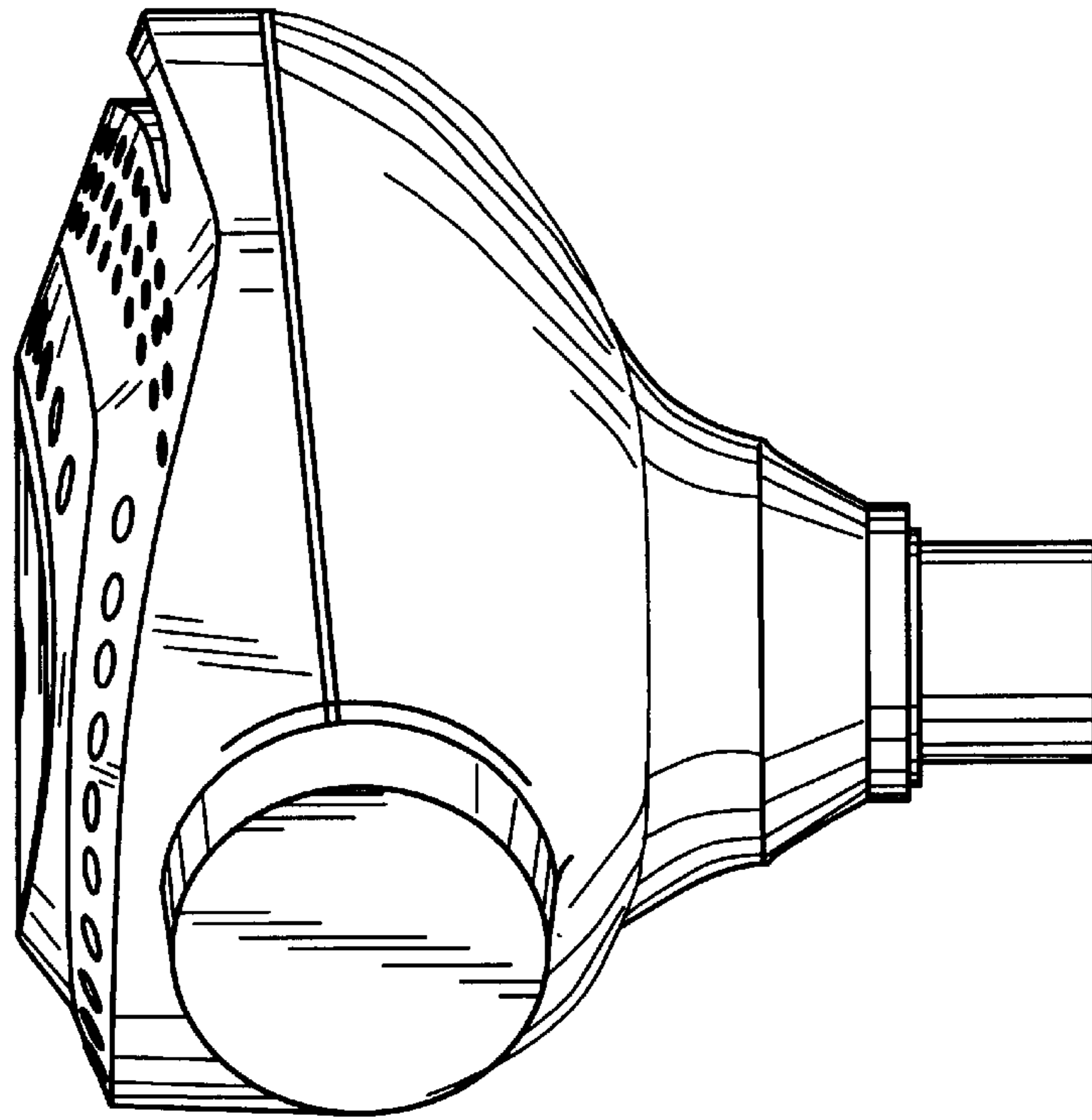

Fig. 9

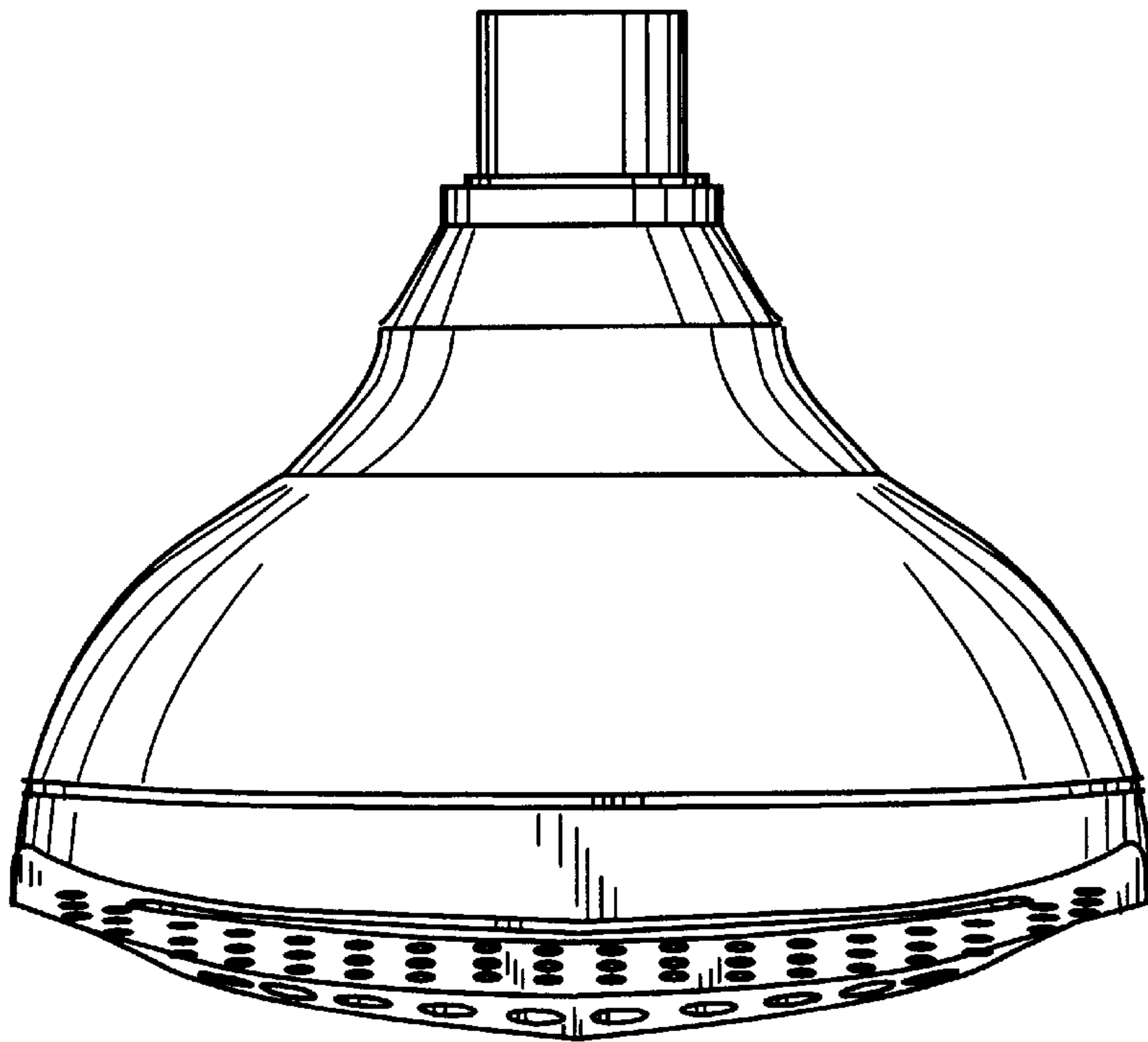

Fig. 10

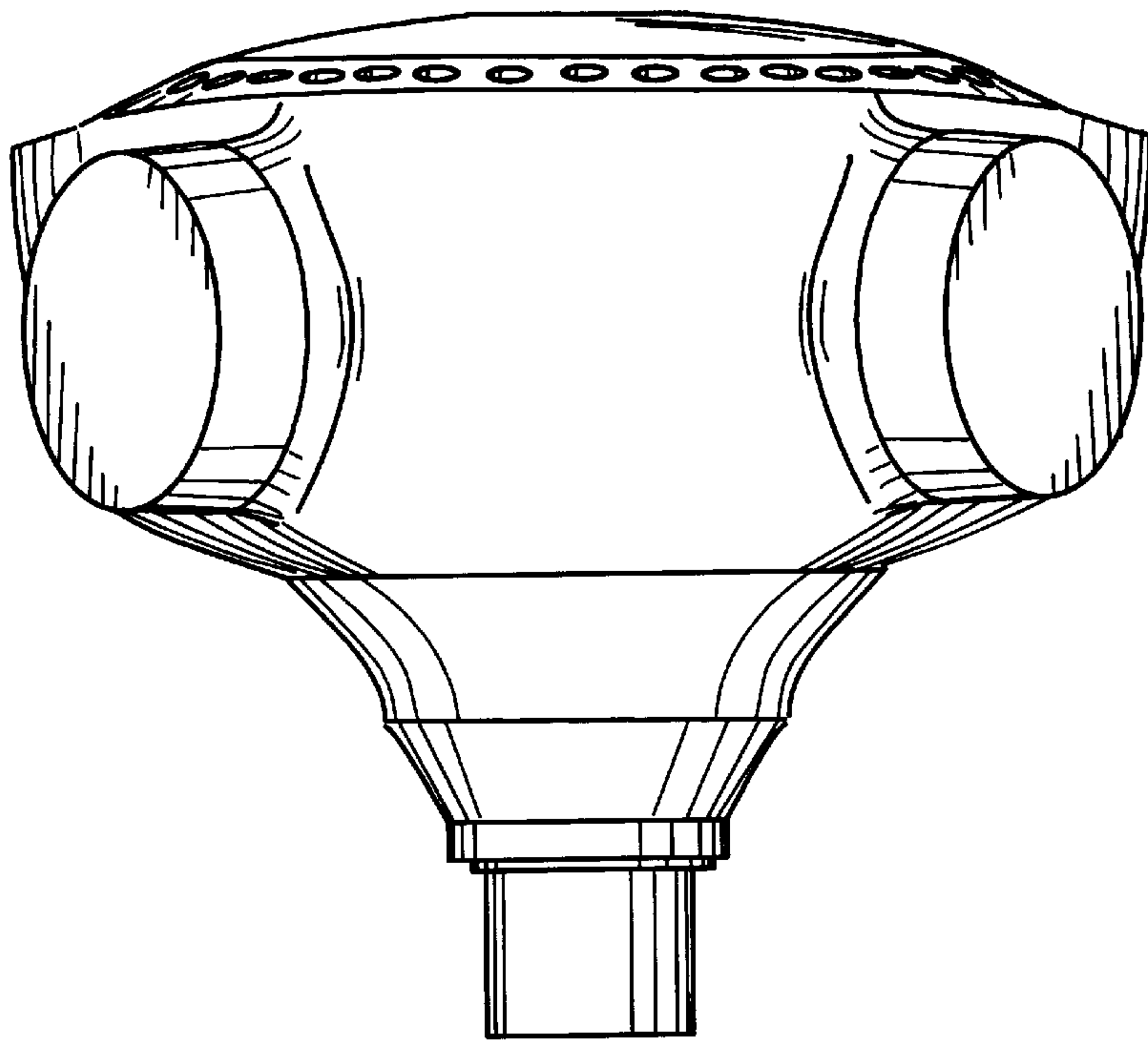

Fig. 11

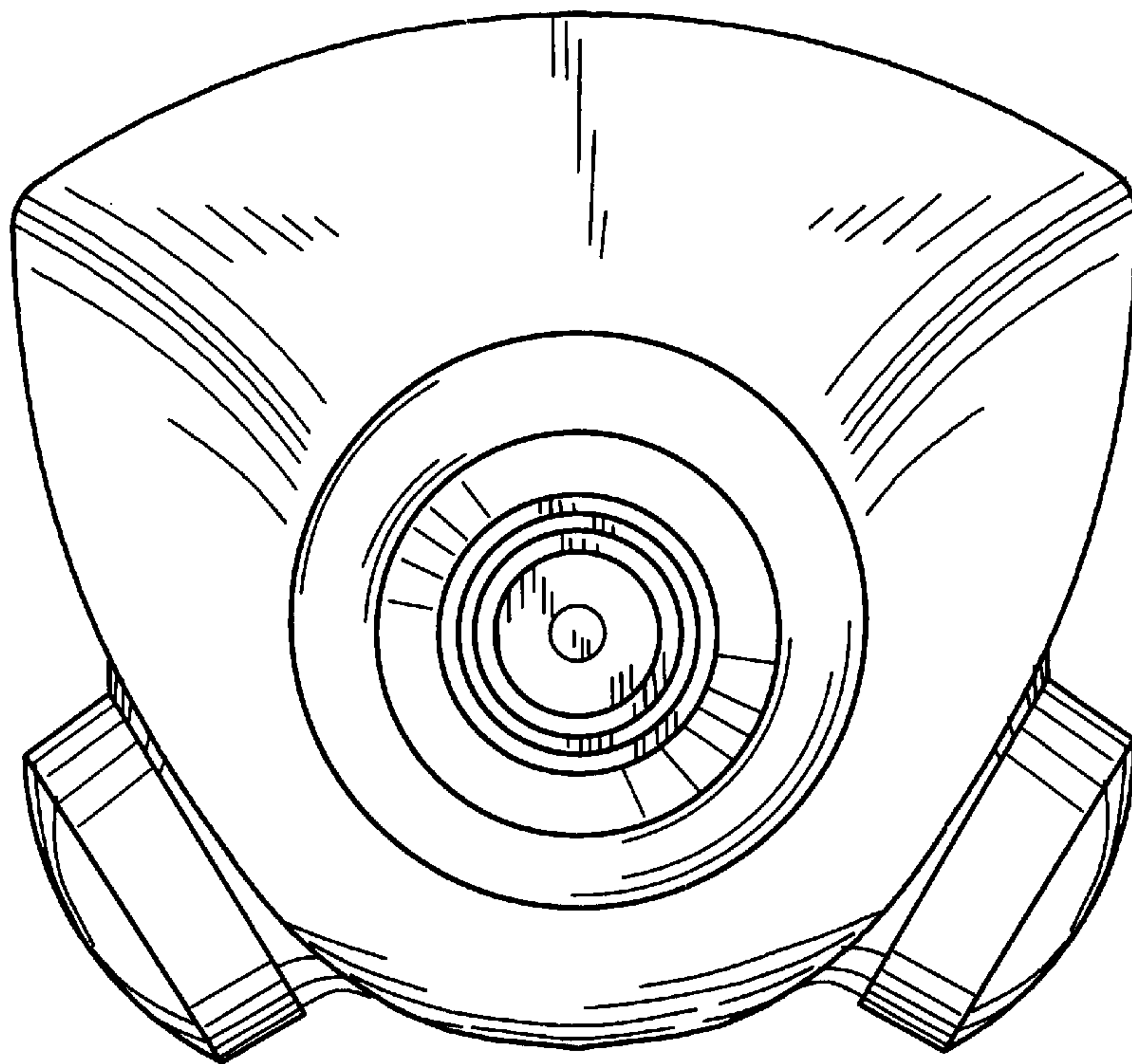

Fig. 12