



US00D427603S

United States Patent [19]

Liu et al.

[11] Patent Number: **Des. 427,603**

[45] Date of Patent: **** Jul. 4, 2000**

[54] **COMPUTER FRONT BEZEL**

D. 413,878 9/1999 Jean et al. D14/441
D. 415,141 8/1999 Jean et al. D14/441

[75] Inventors: **Alvin Liu; Yin Sheng Yeh**, both of Taipei, Taiwan

Primary Examiner—Freda Nunn
Attorney, Agent, or Firm—Wei Te Chung

[73] Assignee: **Hon Hai Precision Ind. Co., Ltd.**, Taipei Hsien, Taiwan

[57] **CLAIM**

[**] Term: **14 Years**

The ornamental design for a computer front bezel, as shown and described.

[21] Appl. No.: **29/113,529**

DESCRIPTION

[22] Filed: **Nov. 4, 1999**

FIG. 1 is a perspective view of a computer front bezel showing our new design;

[51] **LOC (7) Cl.** **14-02**

FIG. 2 is a front elevational view thereof;

[52] **U.S. Cl.** **D14/441**

FIG. 3 is a rear elevational view thereof;

[58] **Field of Search** D14/441, 444, D14/446; D10/103; D13/162, 164, 177, 184, 199; 312/223.2; 361/600, 622, 724, 728

FIG. 4 is a left side elevational view thereof;

FIG. 5 is a right side elevational view thereof;

FIG. 6 is a top plan view thereof;

FIG. 7 is a bottom plan view thereof; and,

FIG. 8 is a perspective view thereof being mounted to a computer case which is shown in broken lines for illustrative purposes only and forms no part of the claimed design.

[56] **References Cited**

U.S. PATENT DOCUMENTS

D. 413,321 8/1999 Su D14/441

1 Claim, 6 Drawing Sheets

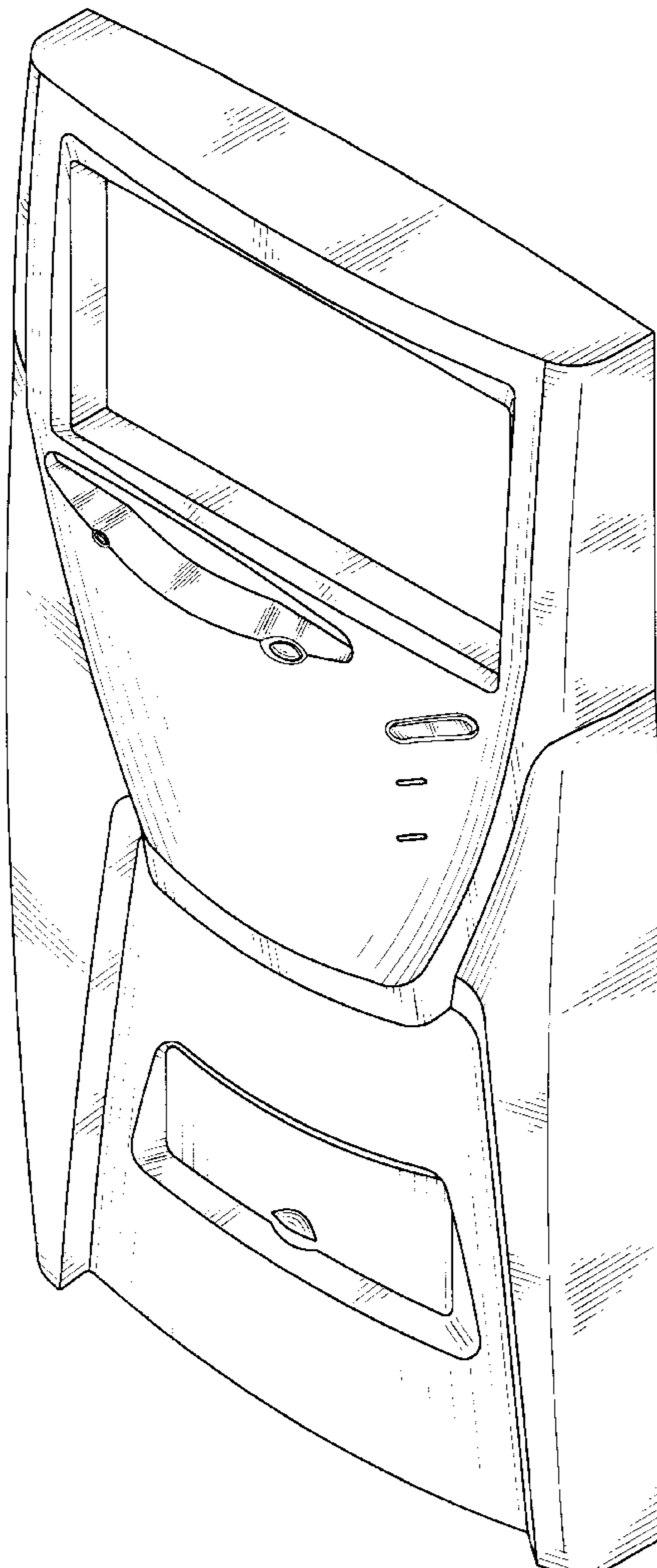

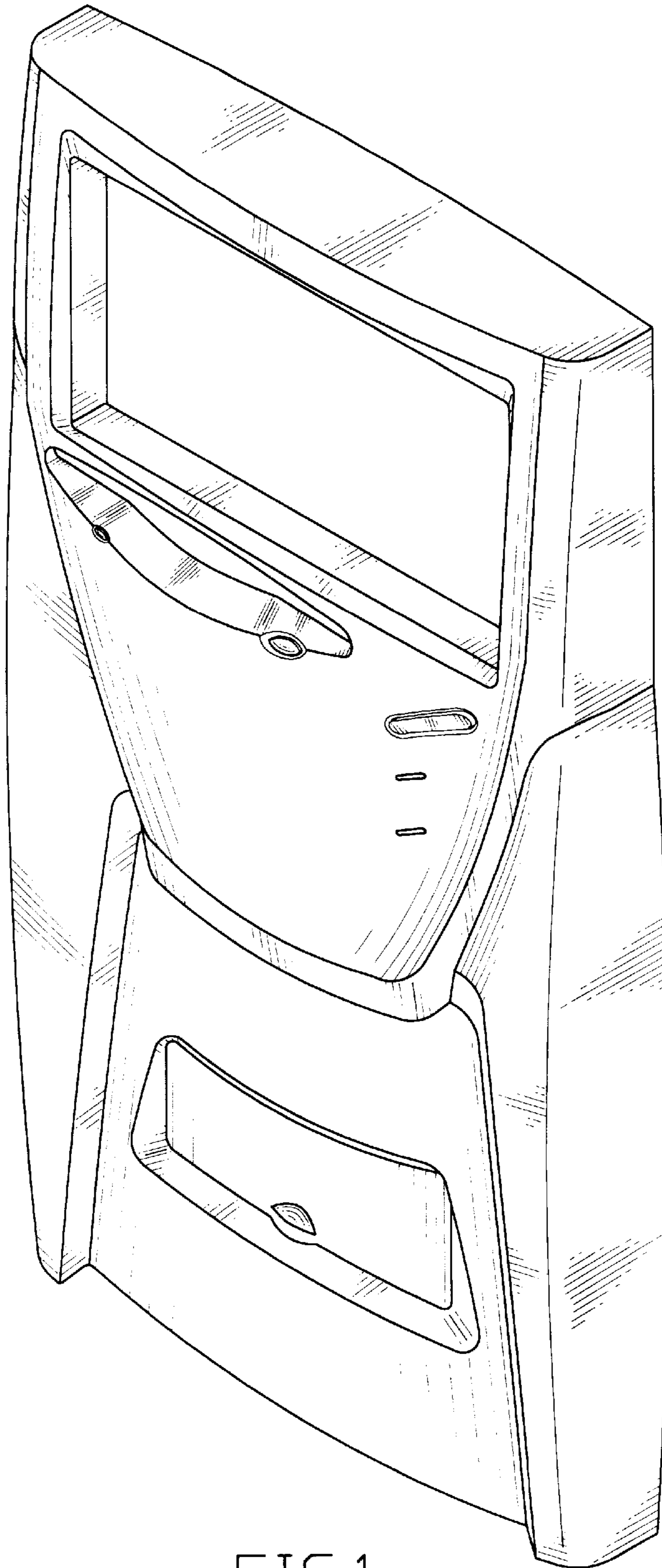

FIG.1

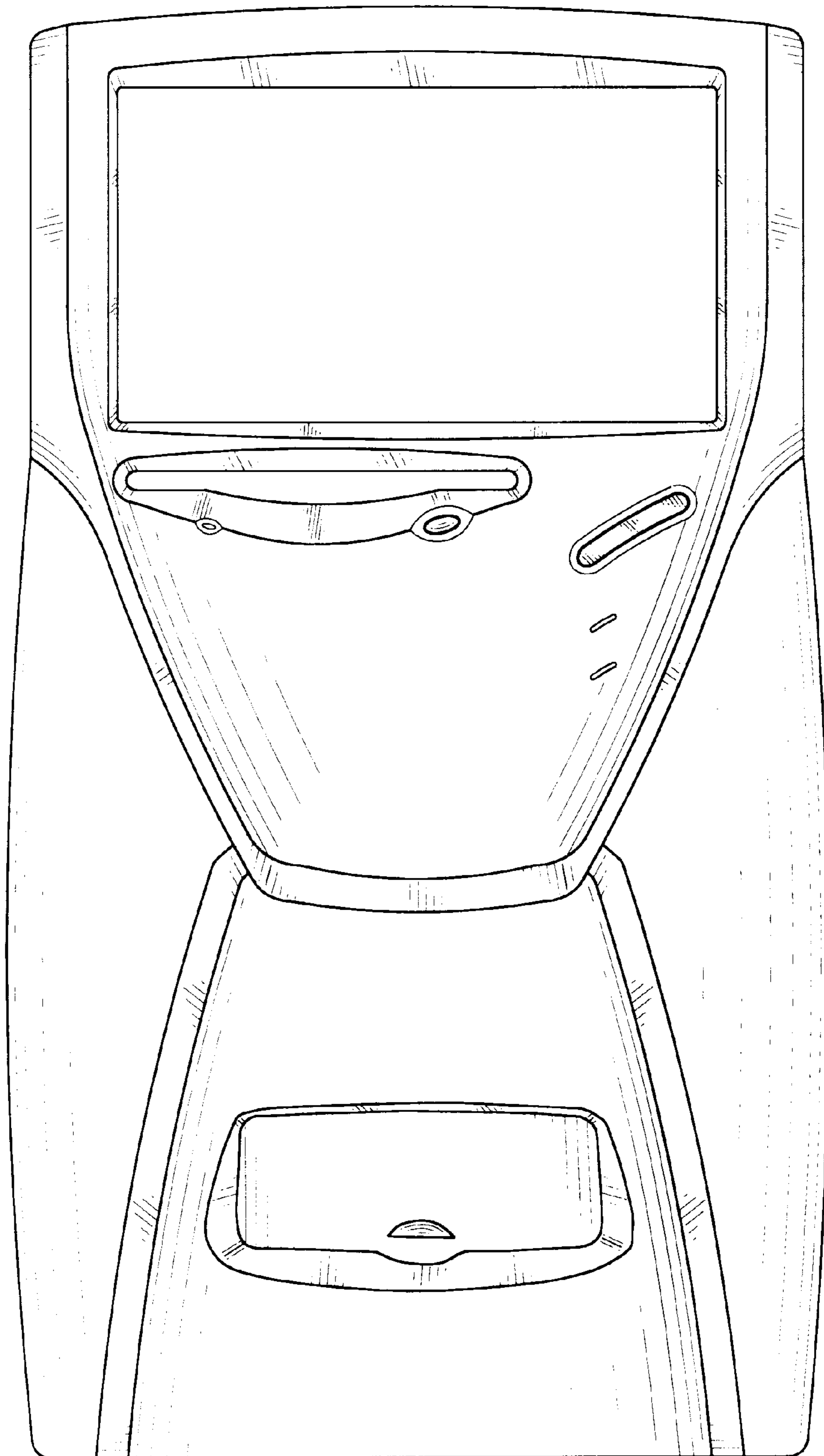

FIG. 2

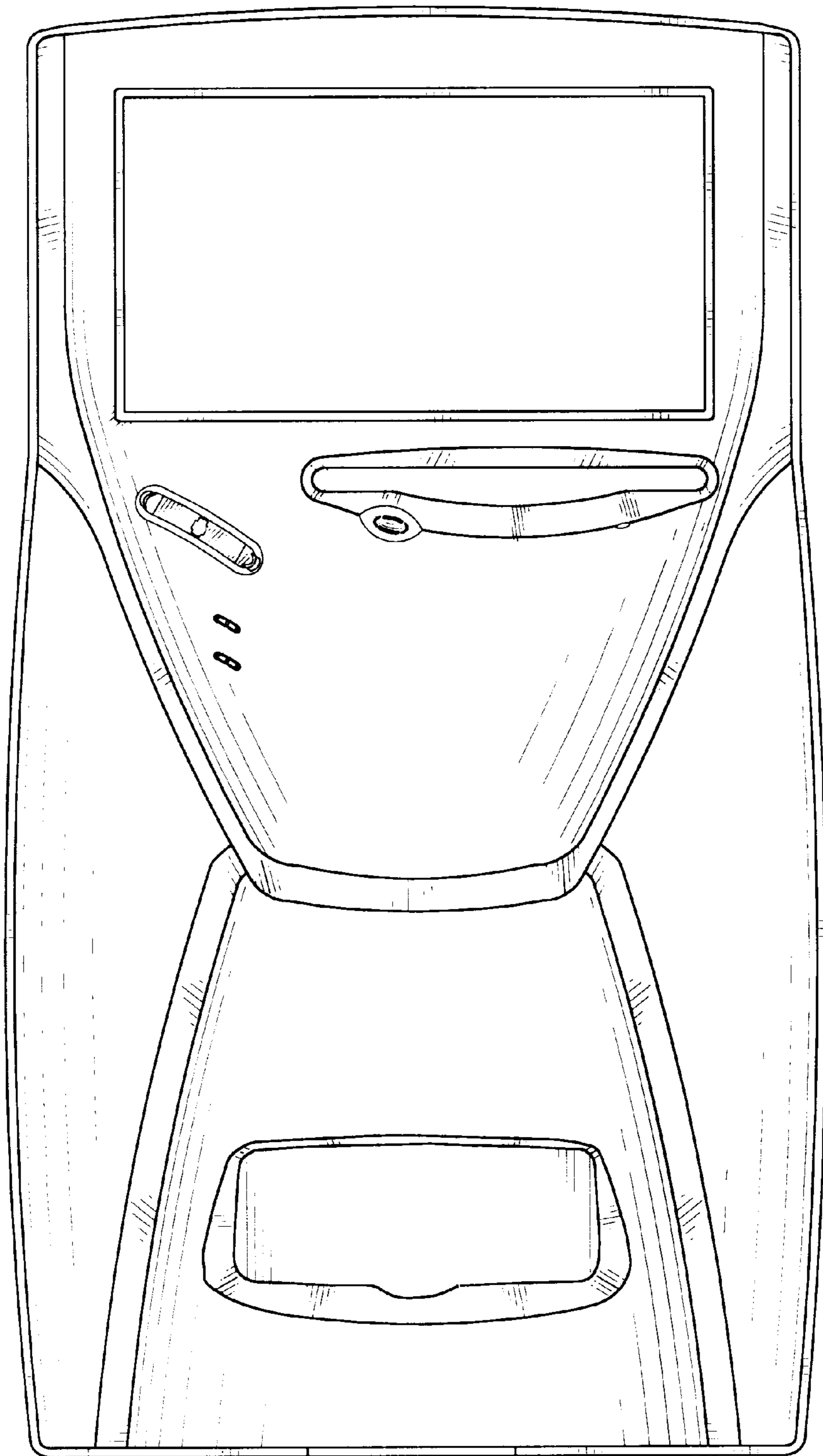

FIG.3

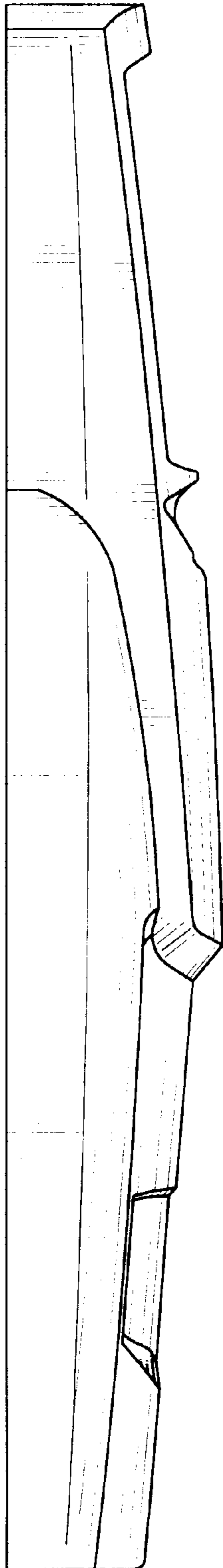

FIG. 4

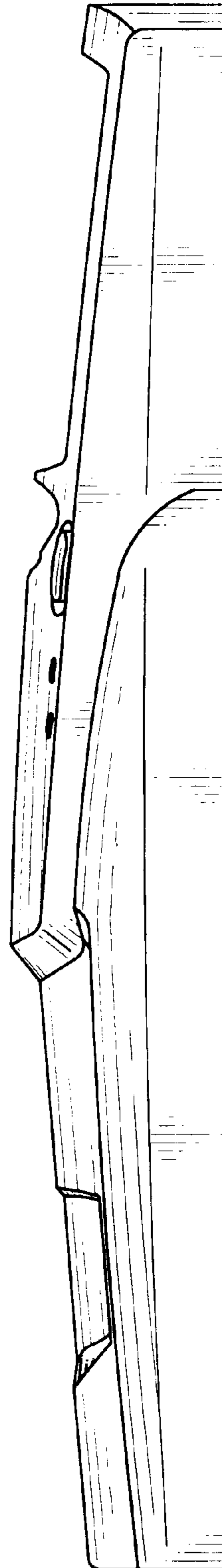

FIG. 5

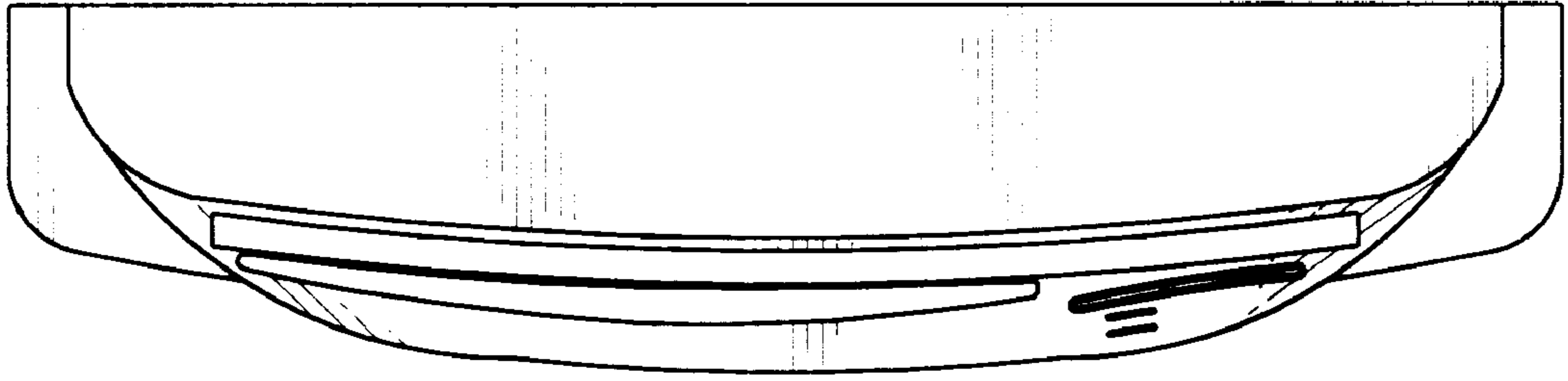

FIG. 6

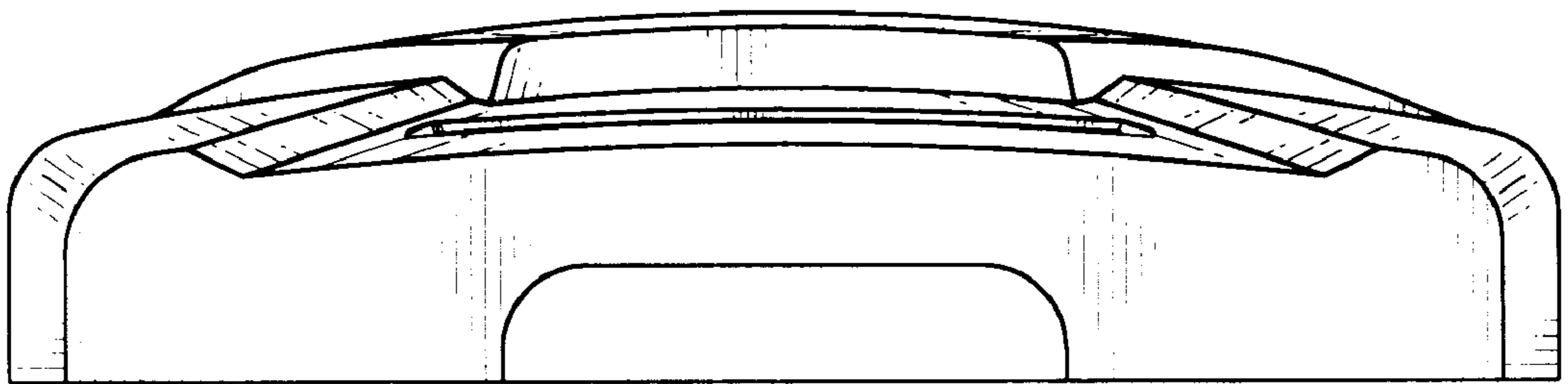

FIG. 7

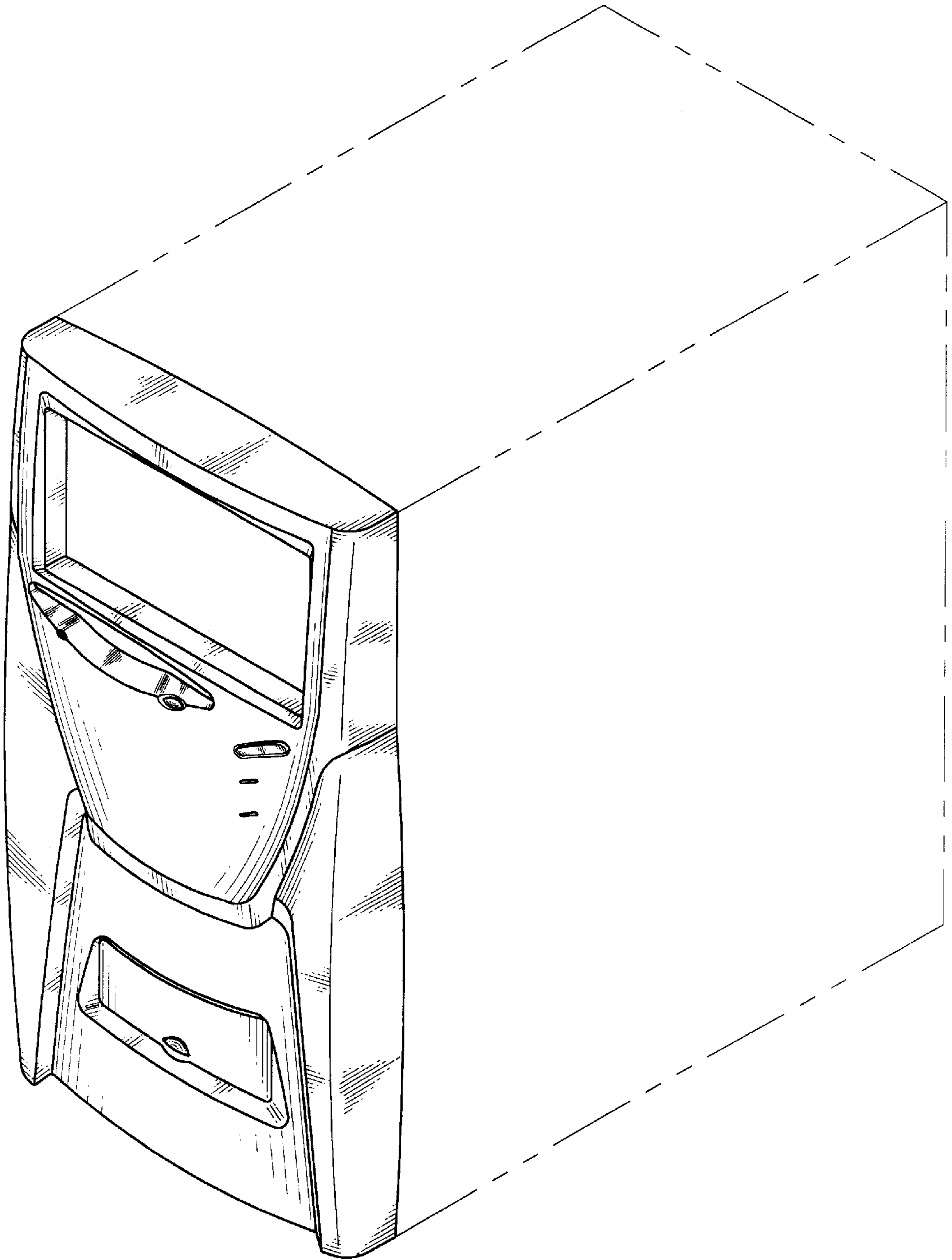

FIG.8