



US00D427574S

# United States Patent [19]

[11] Patent Number: Des. 427,574

Sawada et al.

[45] Date of Patent: \*\* Jul. 4, 2000

## [54] COMPUTER GENERATED IMAGE FOR A DISPLAY PANEL OR SCREEN FOR CONTROLLING OR EDITING IMAGE DATA

[75] Inventors: Koichi Sawada; Makoto Goto; Shigeya Yasui, all of Tokyo, Japan

[73] Assignee: Sony Corporation, Japan

[\*\*] Term: 14 Years

[21] Appl. No.: 29/093,600

[22] Filed: Sep. 15, 1998

[51] LOC (7) Cl. .... 14-02

[52] U.S. Cl. .... D14/114.1

[58] Field of Search ..... D14/114, 114.1-114.9; D18/24-33; D19/6; D20/11; D21/324-33; 345/326, 339-40, 347-57

## [56] References Cited

### U.S. PATENT DOCUMENTS

D. 394,051	5/1998	Smith	.....	D14/114.3
D. 394,250	5/1998	Maitra	.....	D14/114.2
D. 399,836	10/1998	Wu et al.	.....	D14/114.2
D. 400,520	11/1998	Baker et al.	.....	D14/114.2
D. 401,230	11/1998	Marshall, Jr. et al.	.....	D14/114.1
D. 403,313	12/1998	Peppel	.....	D14/114.2

Primary Examiner—M. H. Tung

Attorney, Agent, or Firm—Rader, Fishman & Grauer

## [57] CLAIM

The ornamental design for a computer generated image for a display panel or screen for controlling or editing image data, as shown and described.

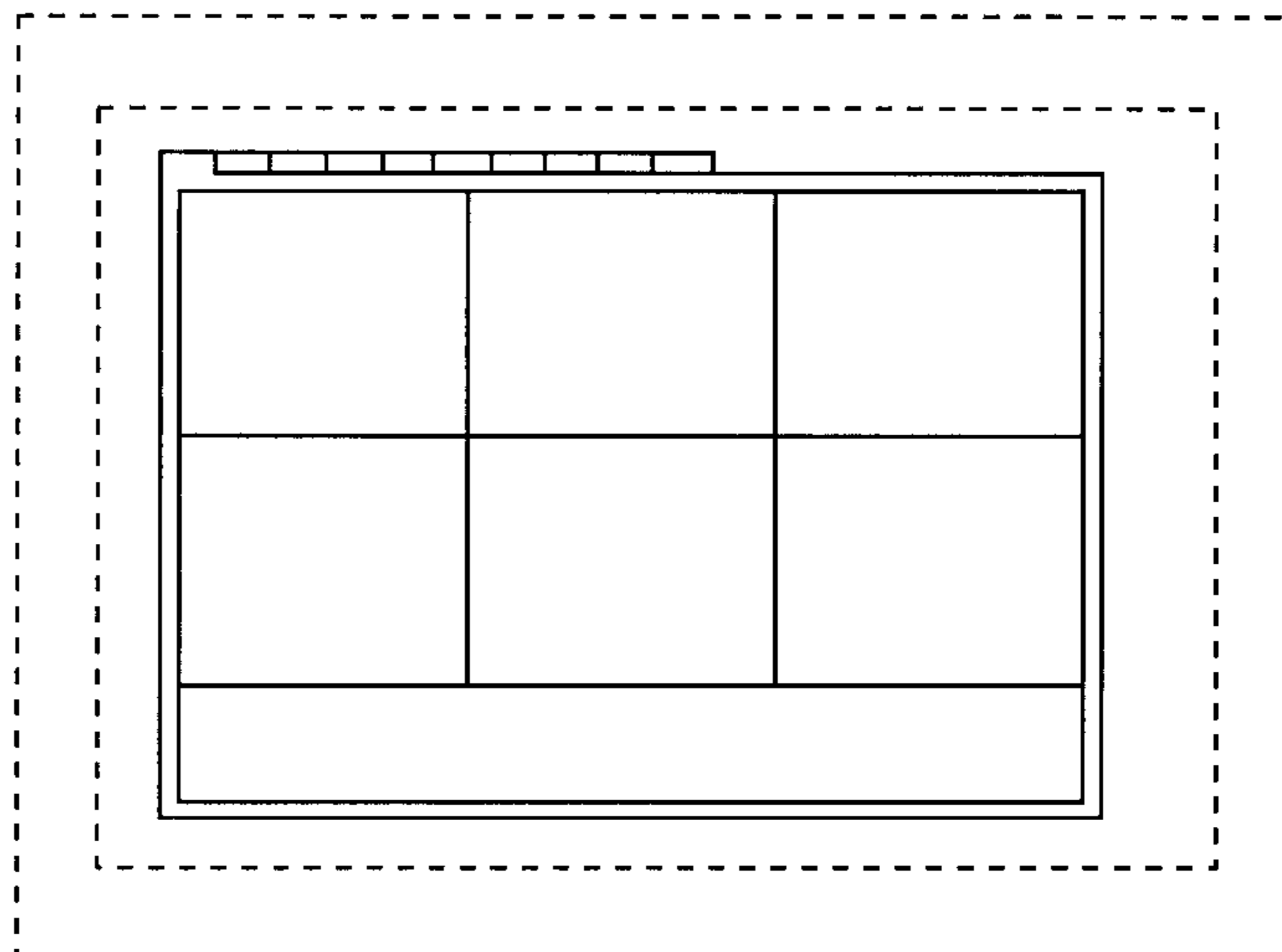
### DESCRIPTION

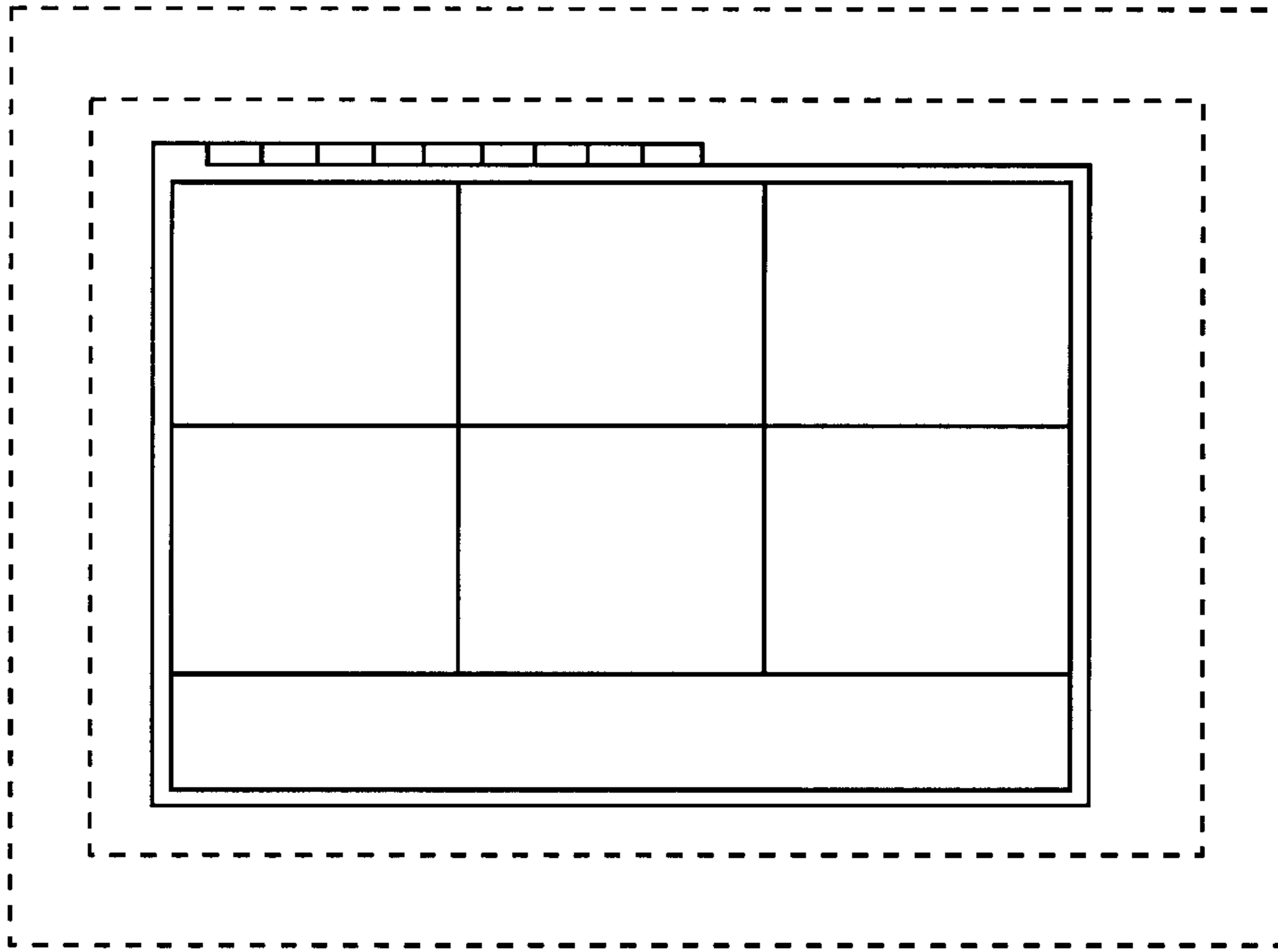
FIG. 1 is a front view of a computer generated image on a display panel and screen;  
FIG. 2 is a front view of a second embodiment thereof;  
FIG. 3 is a front view of a third embodiment thereof;  
FIG. 4 is a front view of a fourth embodiment thereof;

FIG. 5 is a front view of a fifth embodiment thereof;  
FIG. 6 is a front view of a sixth embodiment thereof;  
FIG. 7 is a front view of a seventh embodiment thereof;  
FIG. 8 is a front view of an eighth embodiment thereof;  
FIG. 9 is a front view of a ninth embodiment thereof;  
FIG. 10 is a front view of a tenth embodiment thereof;  
FIG. 11 is a front view of a eleventh embodiment thereof;  
FIG. 12 is a front view of a twelfth embodiment thereof;  
FIG. 13 is a front view of a thirteenth embodiment thereof;  
FIG. 14 is a front view of a fourteenth embodiment thereof;  
FIG. 15 is a front view of a fifteenth embodiment thereof;  
FIG. 16 is a front view of a sixteenth embodiment thereof;  
FIG. 17 is a front view of a seventeenth embodiment thereof;  
FIG. 18 is a front view of an eighteenth embodiment thereof;  
FIG. 19 is a front view of a nineteenth embodiment thereof;  
FIG. 20 is a front view of a twentieth embodiment thereof;  
FIG. 21 is a front view of a twenty-first embodiment thereof;  
FIG. 22 is a front view of a twenty-second embodiment thereof;  
FIG. 23 is a front view of a twenty-third embodiment thereof;  
FIG. 24 is a front view of a twenty-fourth embodiment thereof;  
FIG. 25 is a front view of a twenty-fifth embodiment thereof;  
FIG. 26 is a front view of a twenty-sixth embodiment thereof;  
FIG. 27 is a front view of a twenty-seventh embodiment thereof;  
FIG. 28 is a front view of a twenty-eighth embodiment thereof;  
FIG. 29 is a front view of a twenty-ninth embodiment thereof;  
FIG. 30 is a front view of a thirtieth embodiment thereof;  
FIG. 31 is a front view of a thirty-first embodiment thereof;  
and,  
FIG. 32 is a front view of a thirty-second embodiment thereof.

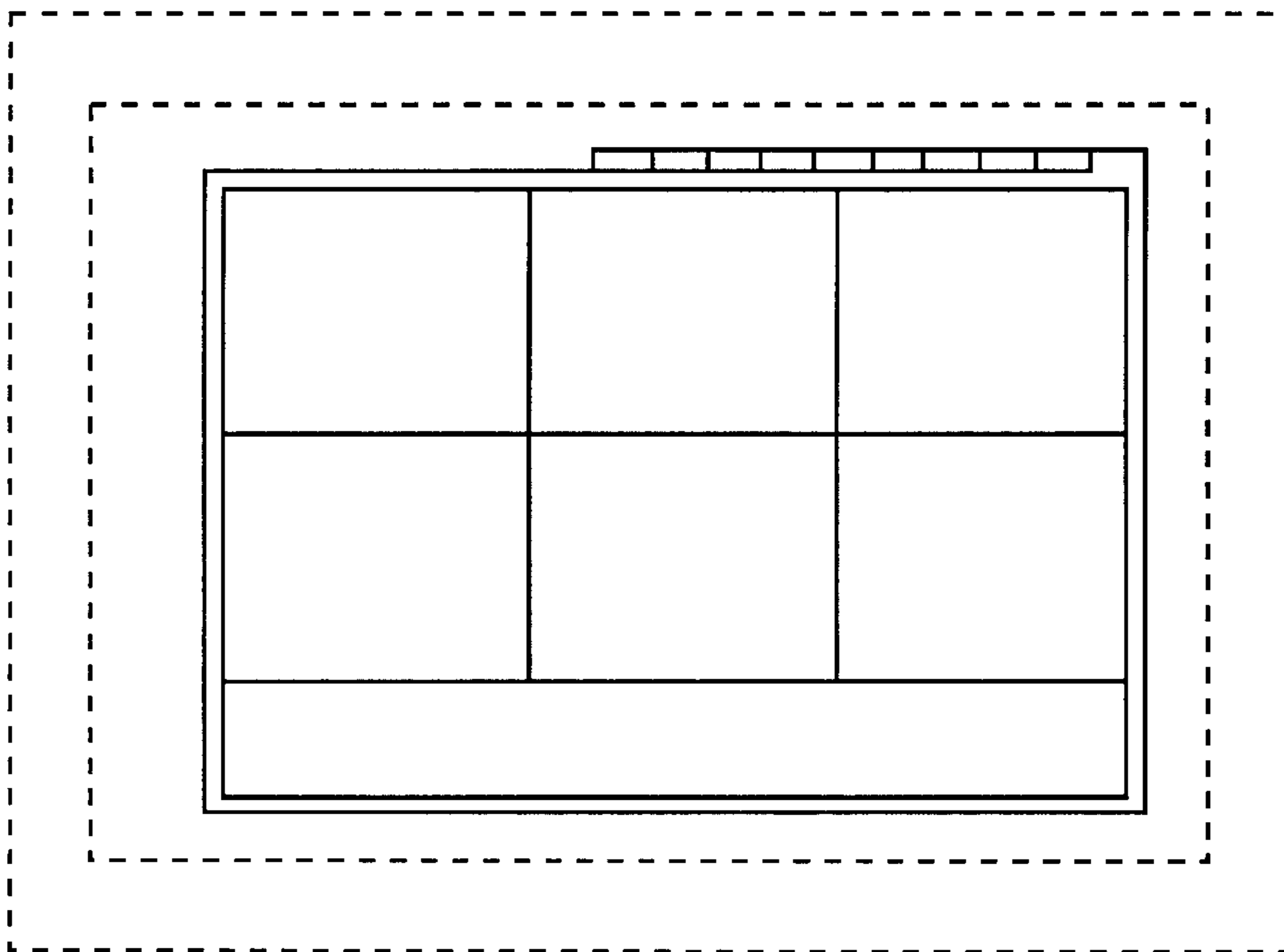
The broken line drawing of a display panel and screen in all views is for illustrative purposes only and forms no part of the claimed design.

1 Claim, 16 Drawing Sheets

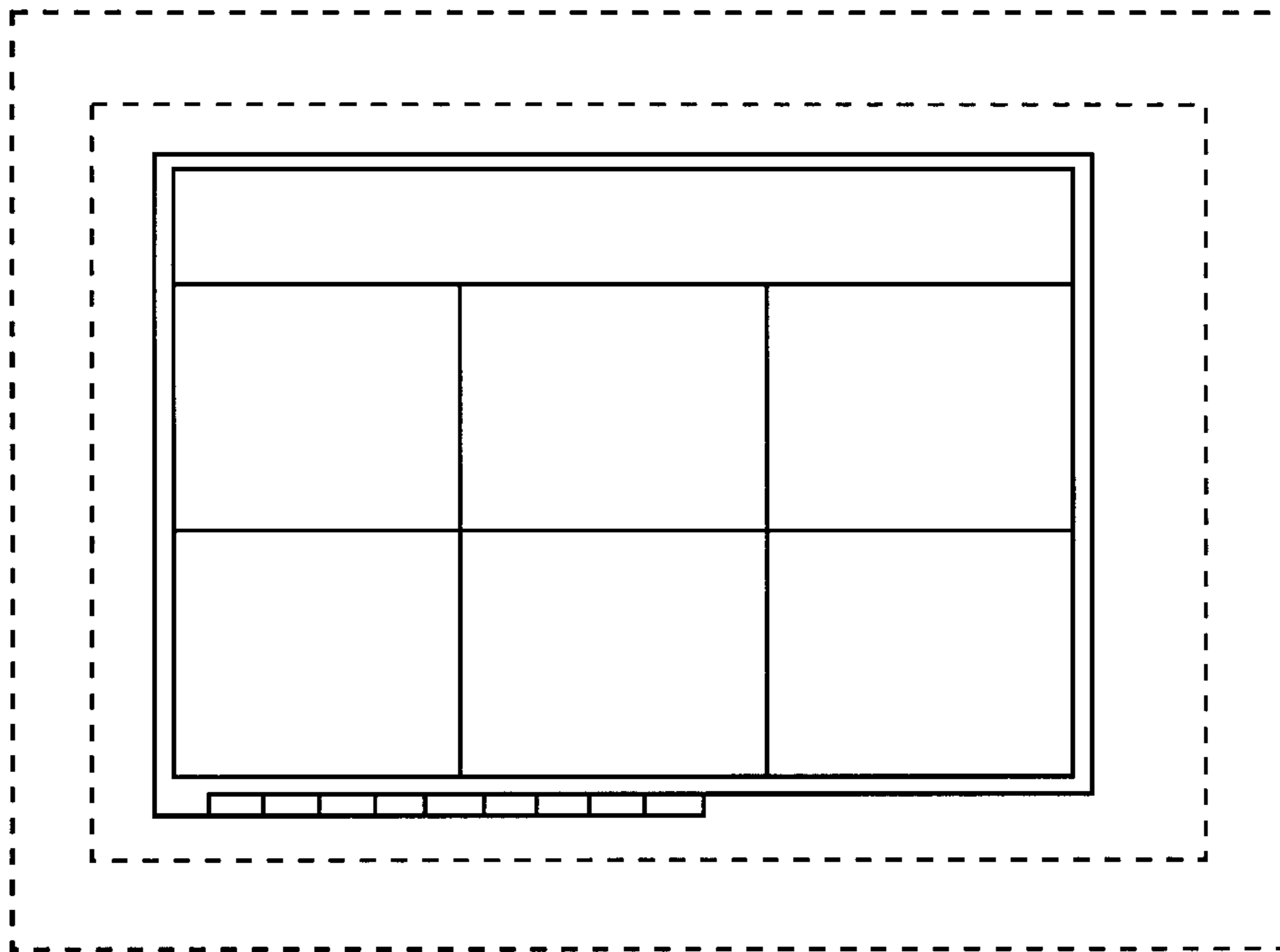




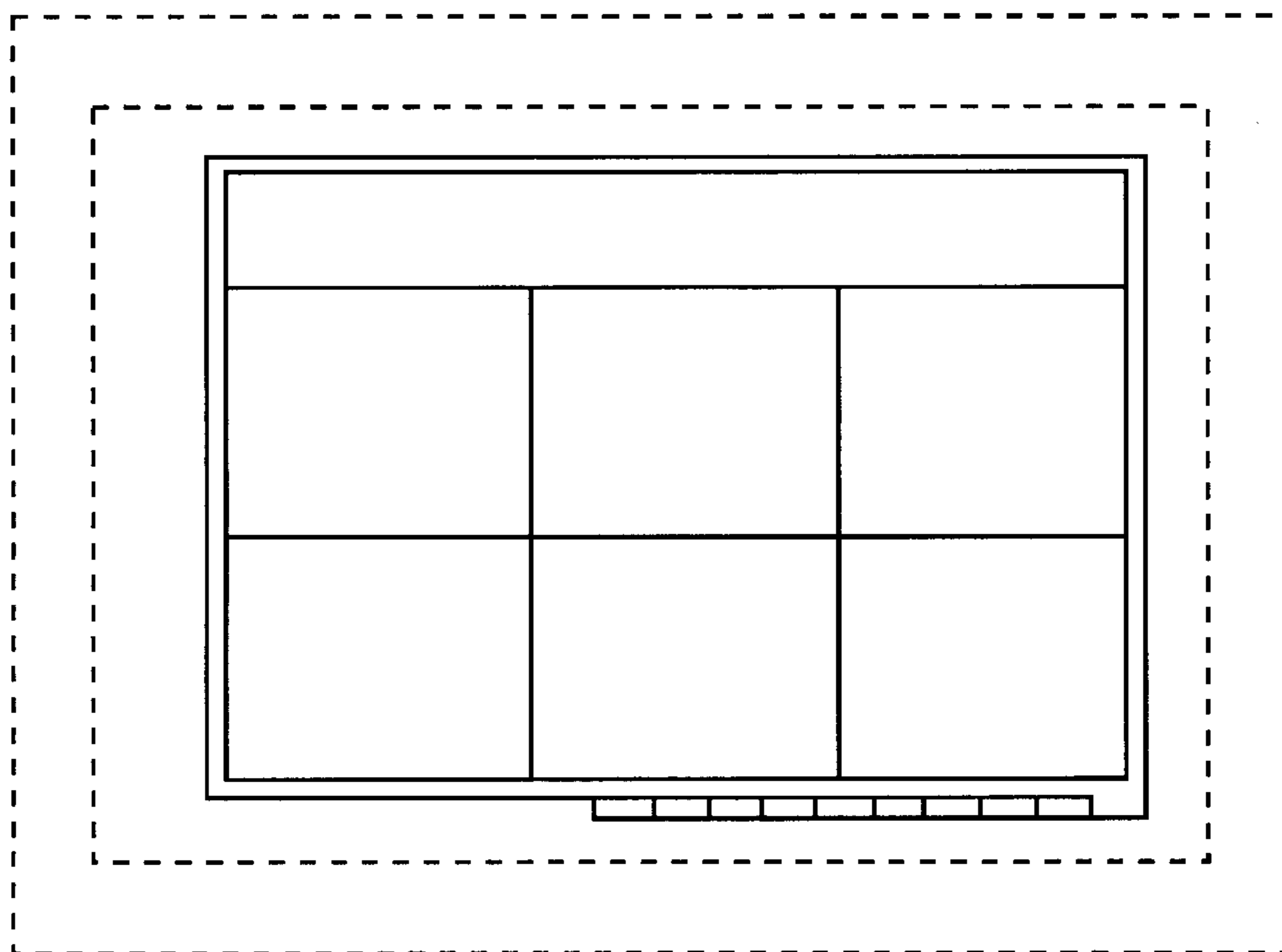
**FIG. 1**



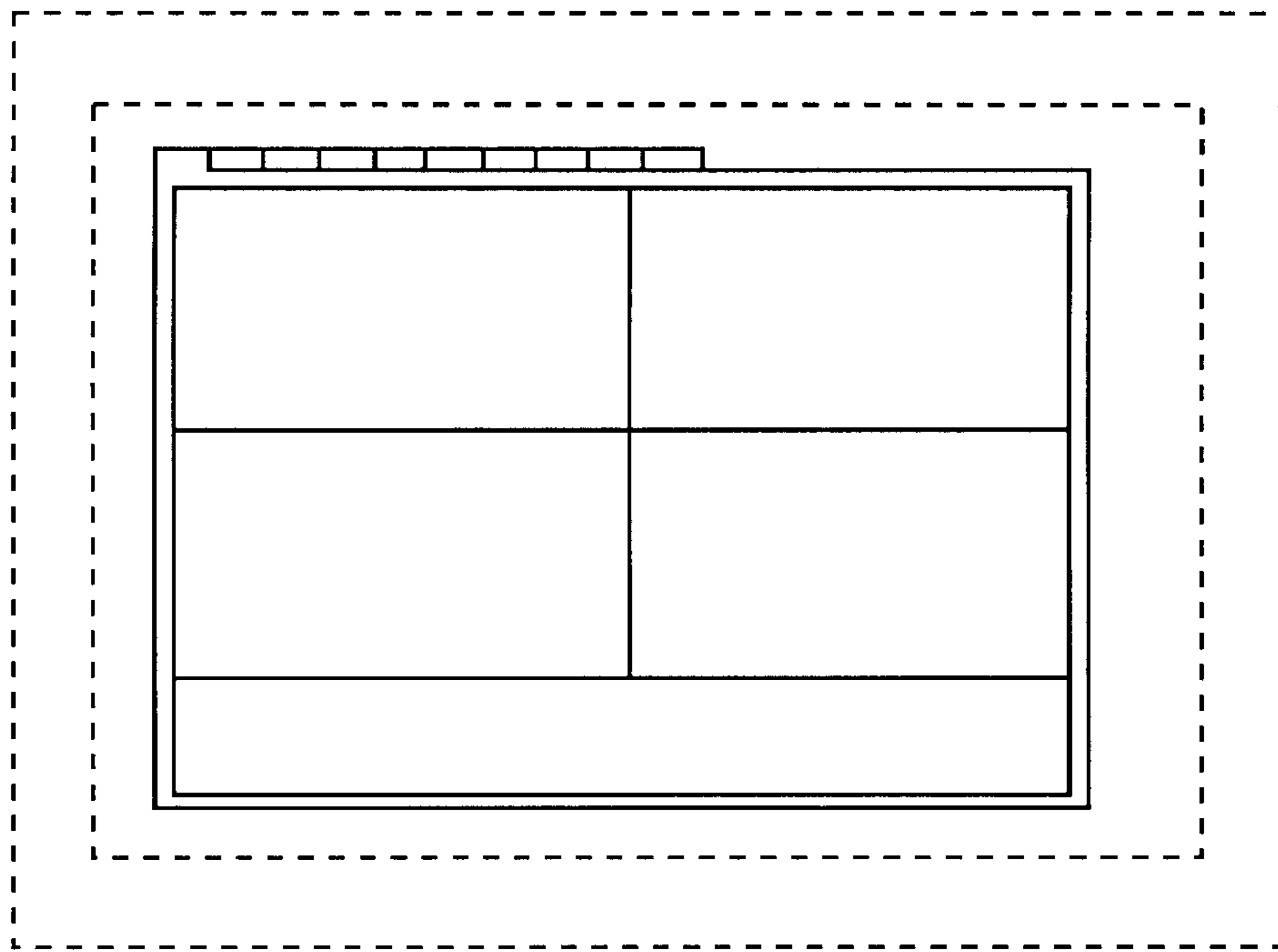
**FIG. 2**



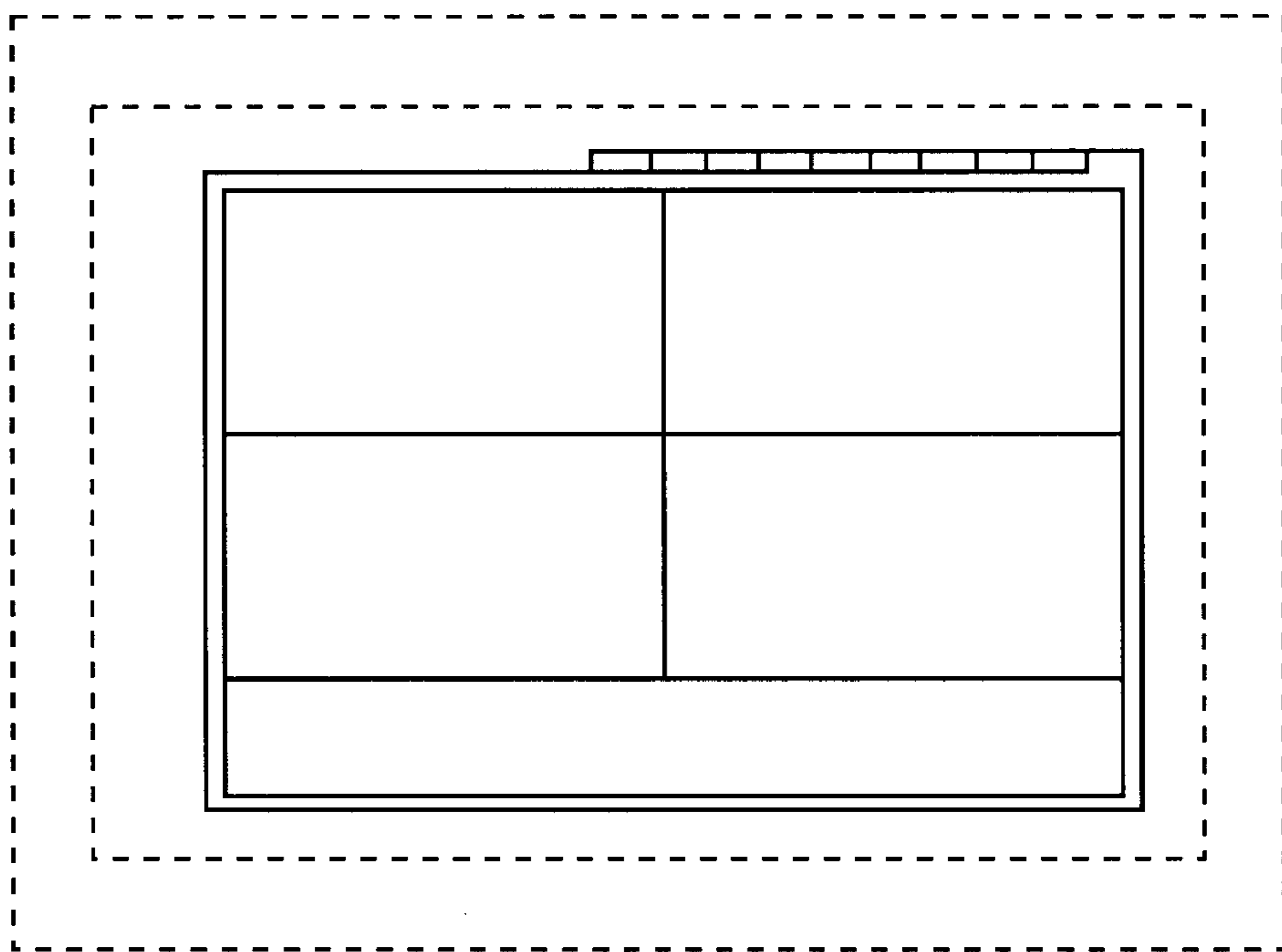
**FIG. 3**



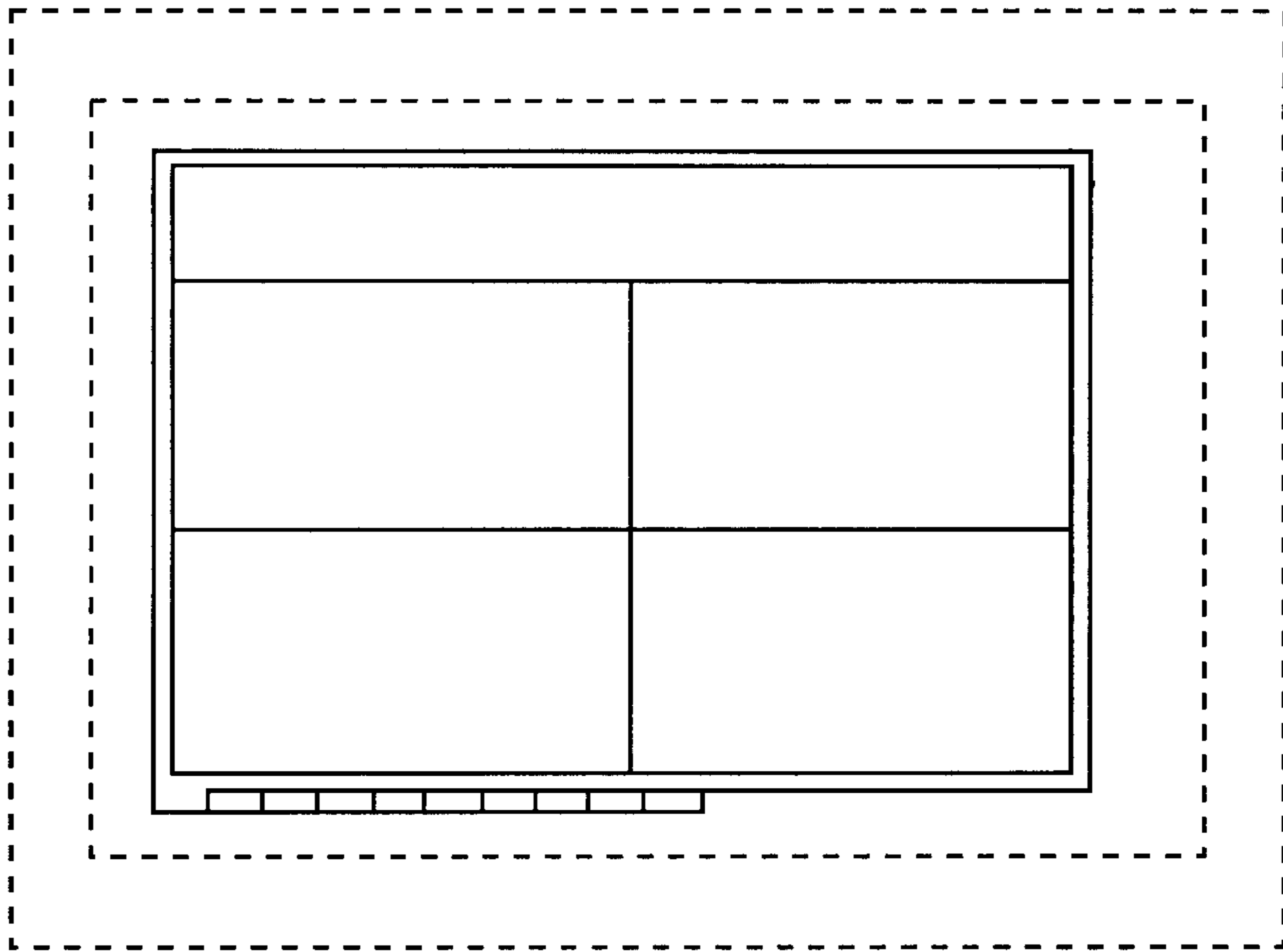
**FIG. 4**



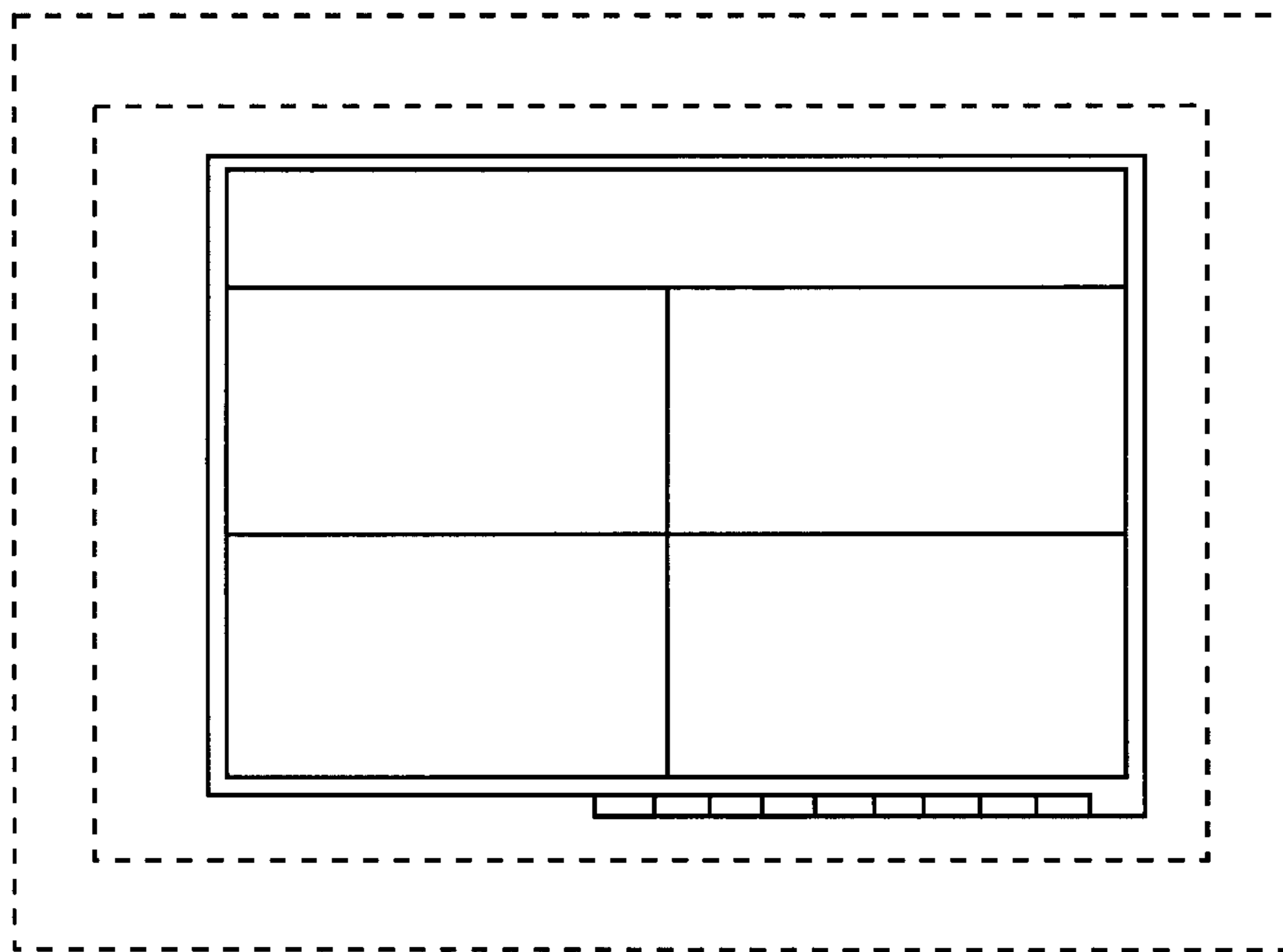
**FIG. 5**



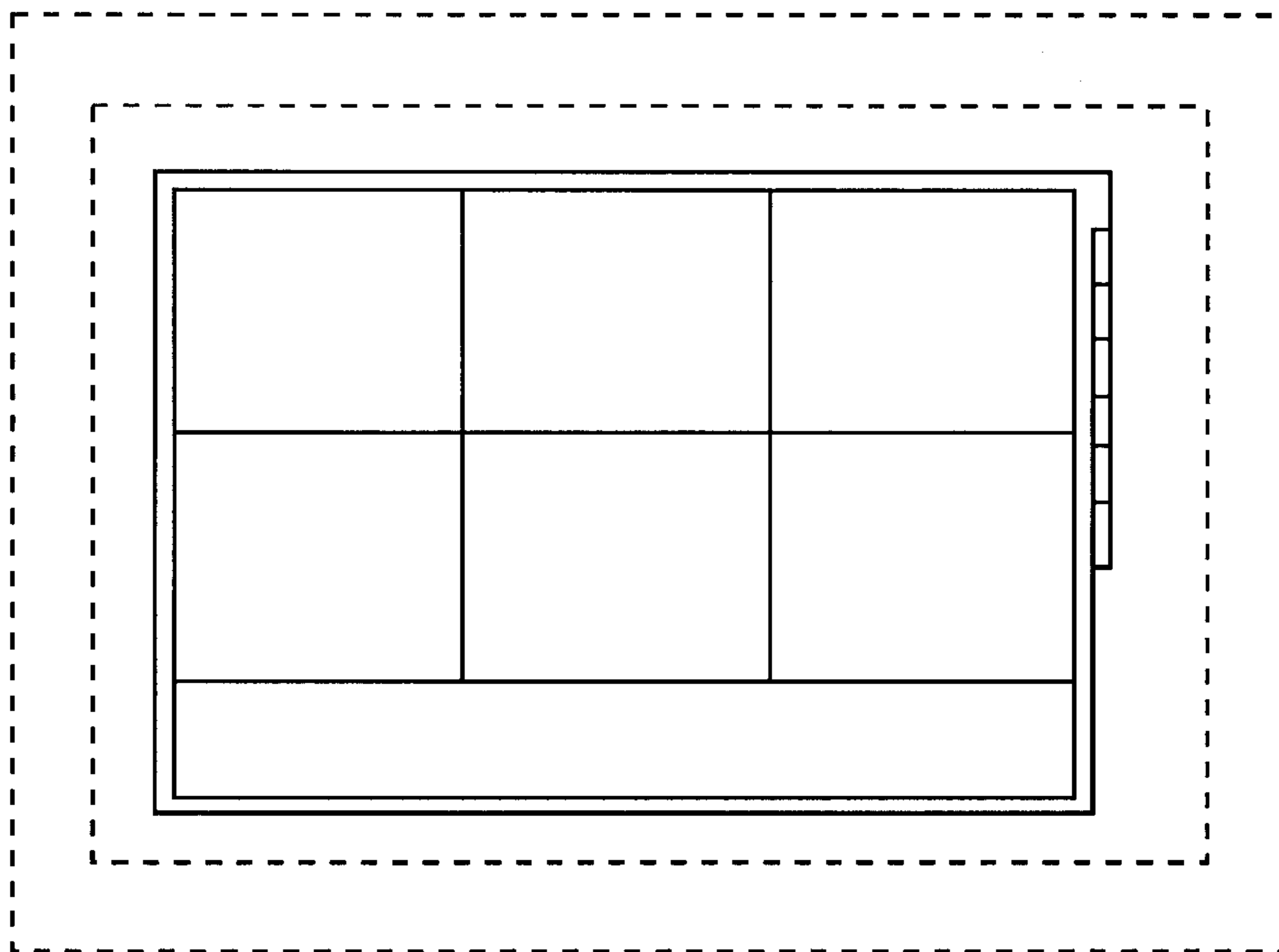
**FIG. 6**



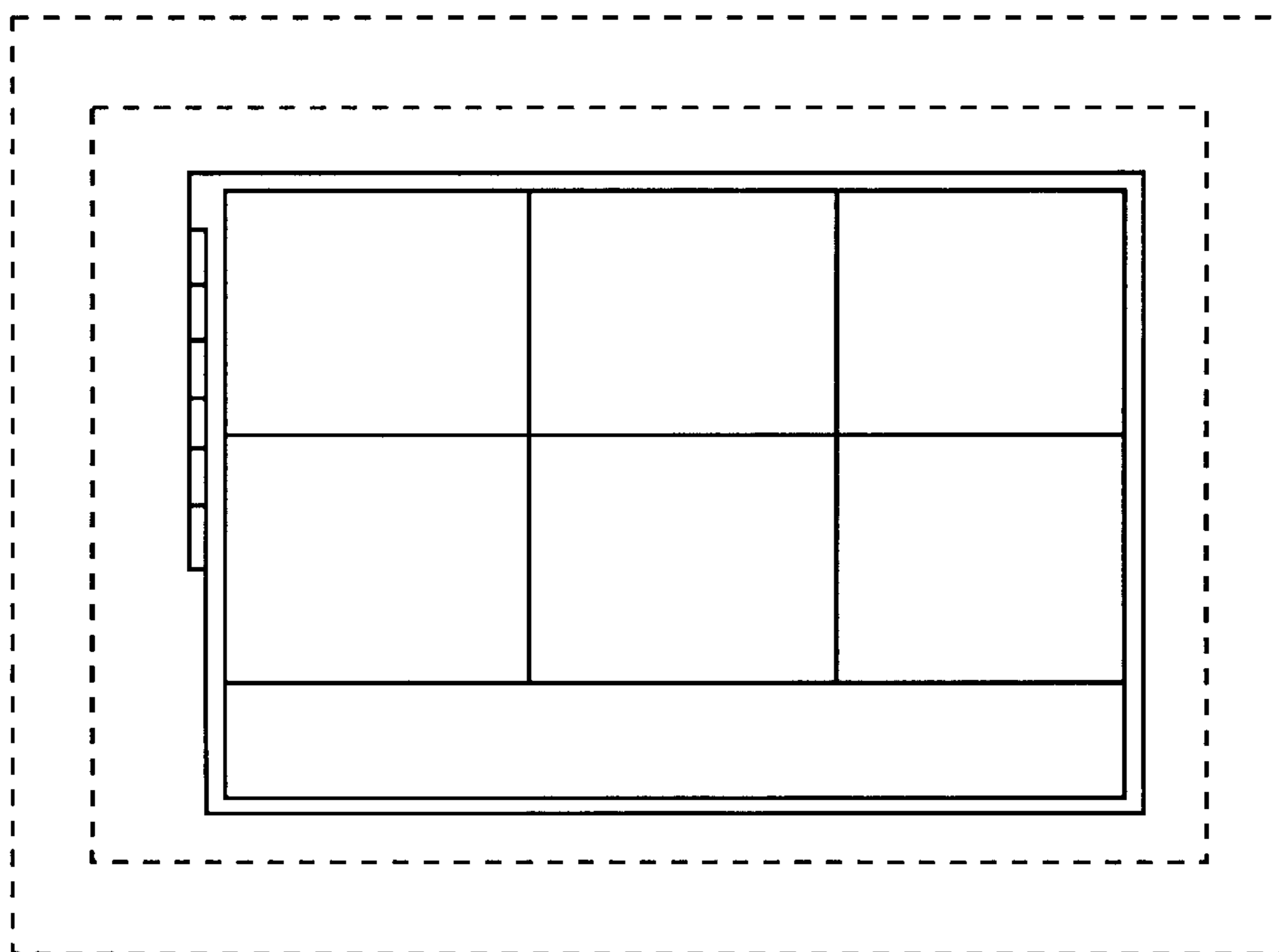
**FIG. 7**



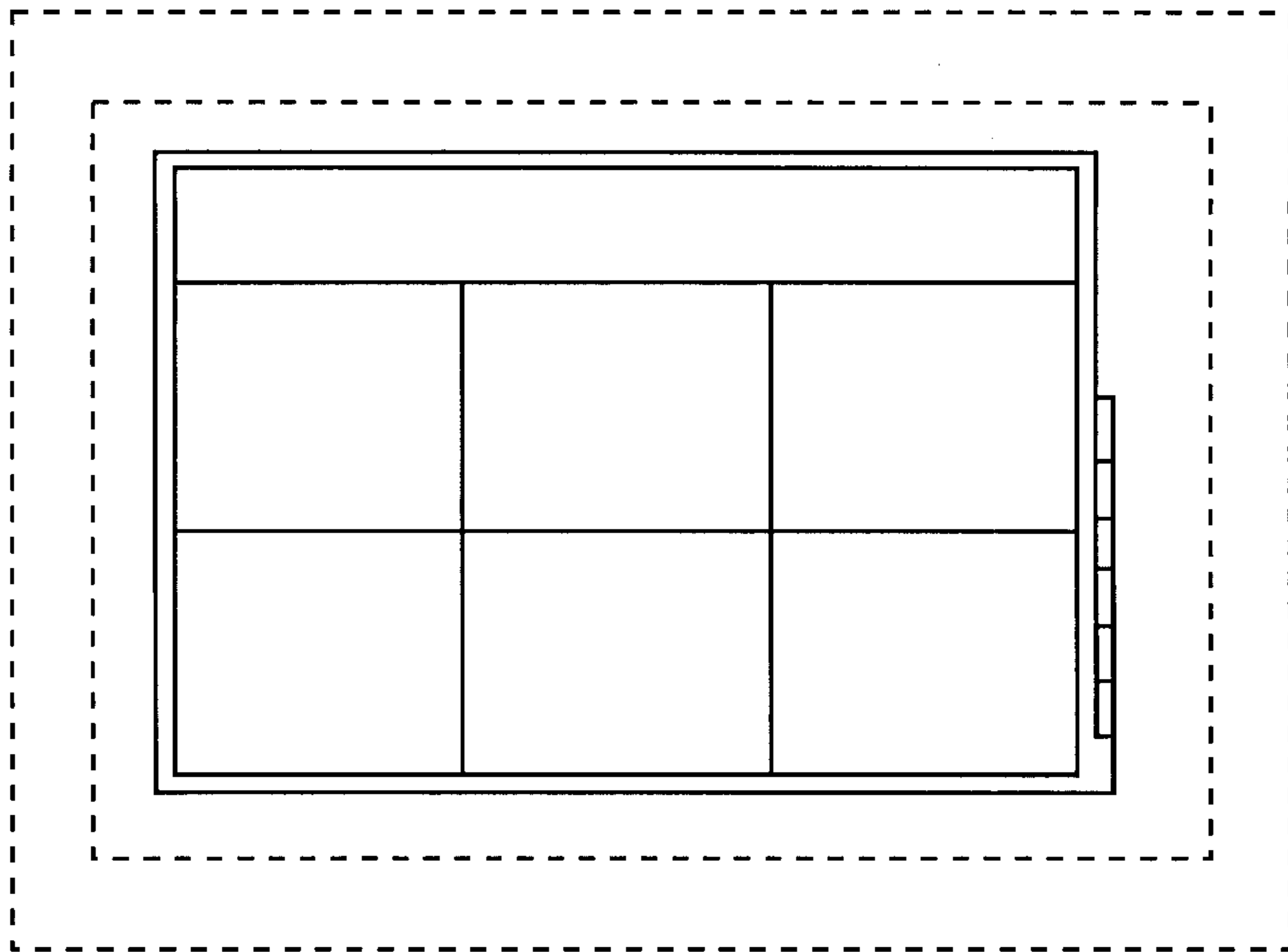
**FIG. 8**



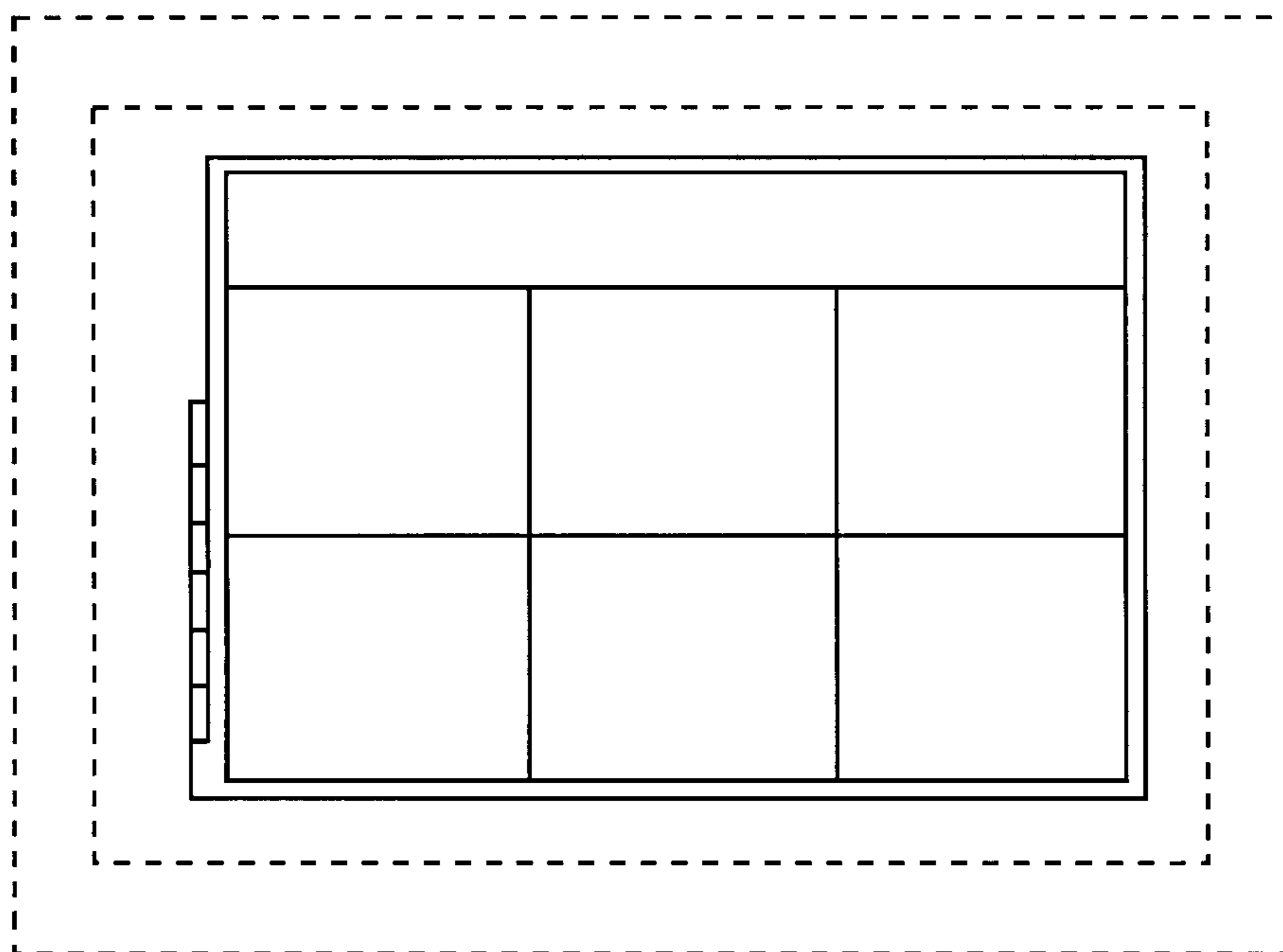
**FIG. 9**



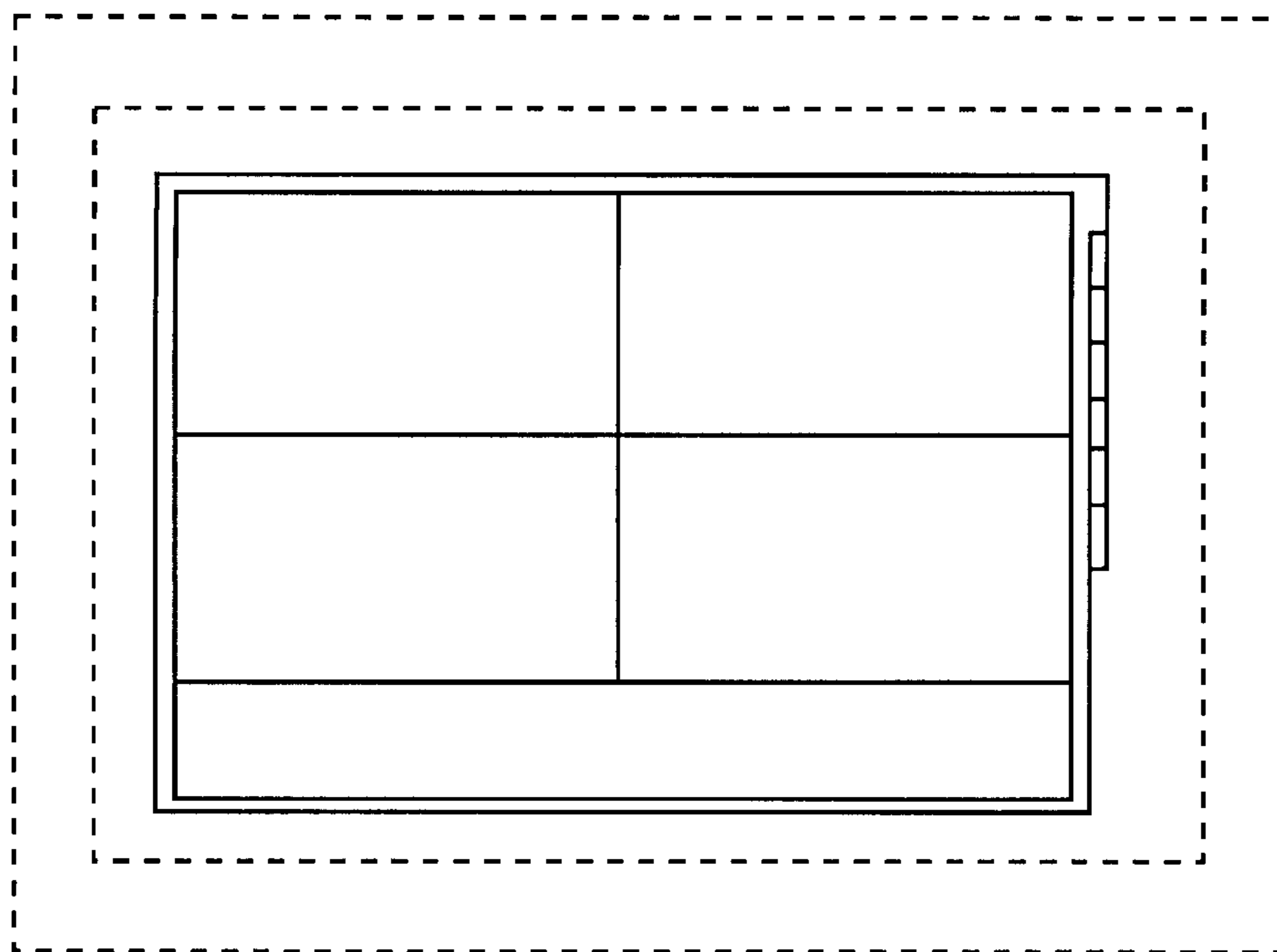
**FIG. 10**



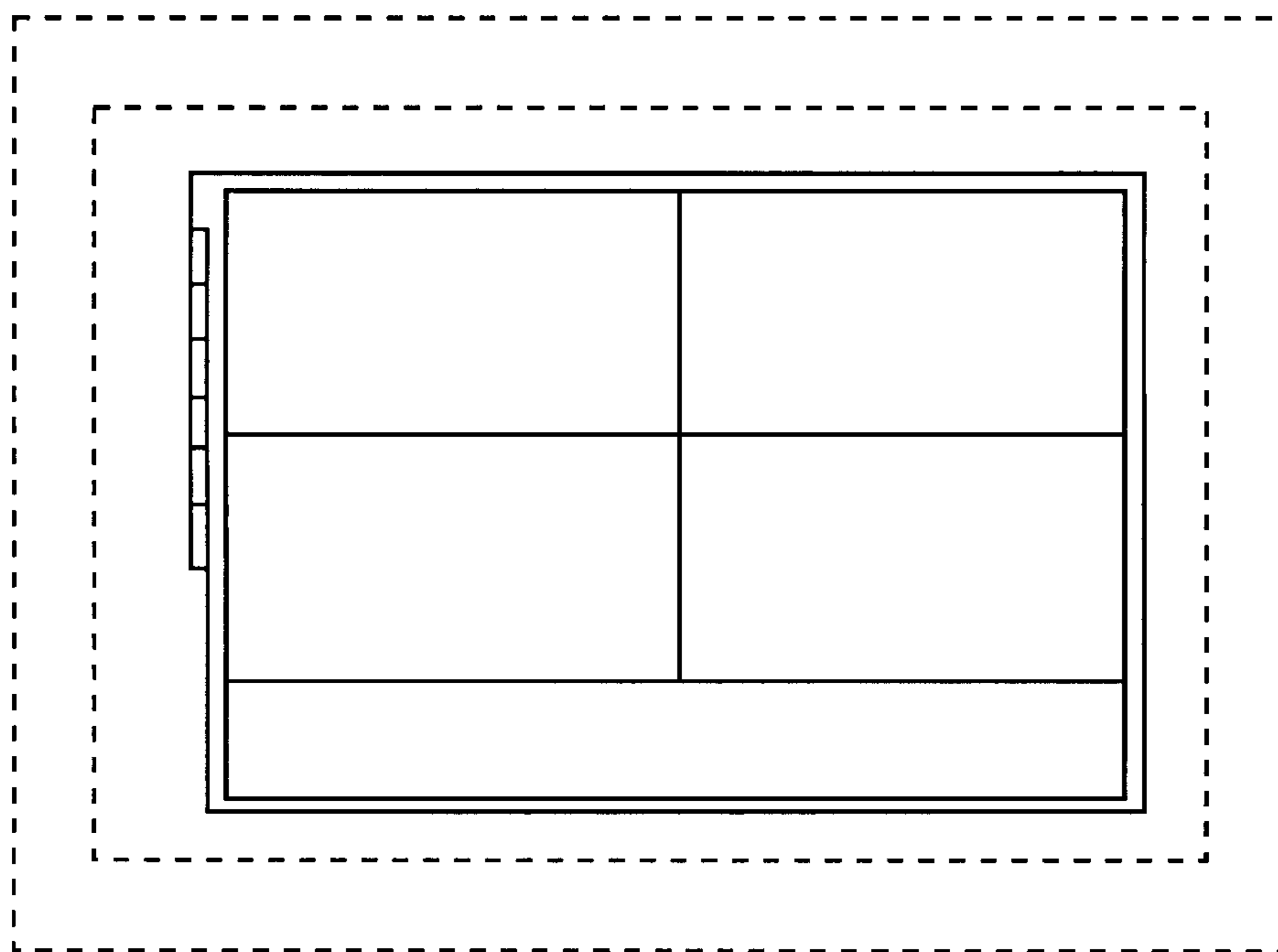
**FIG. 11**



**FIG. 12**

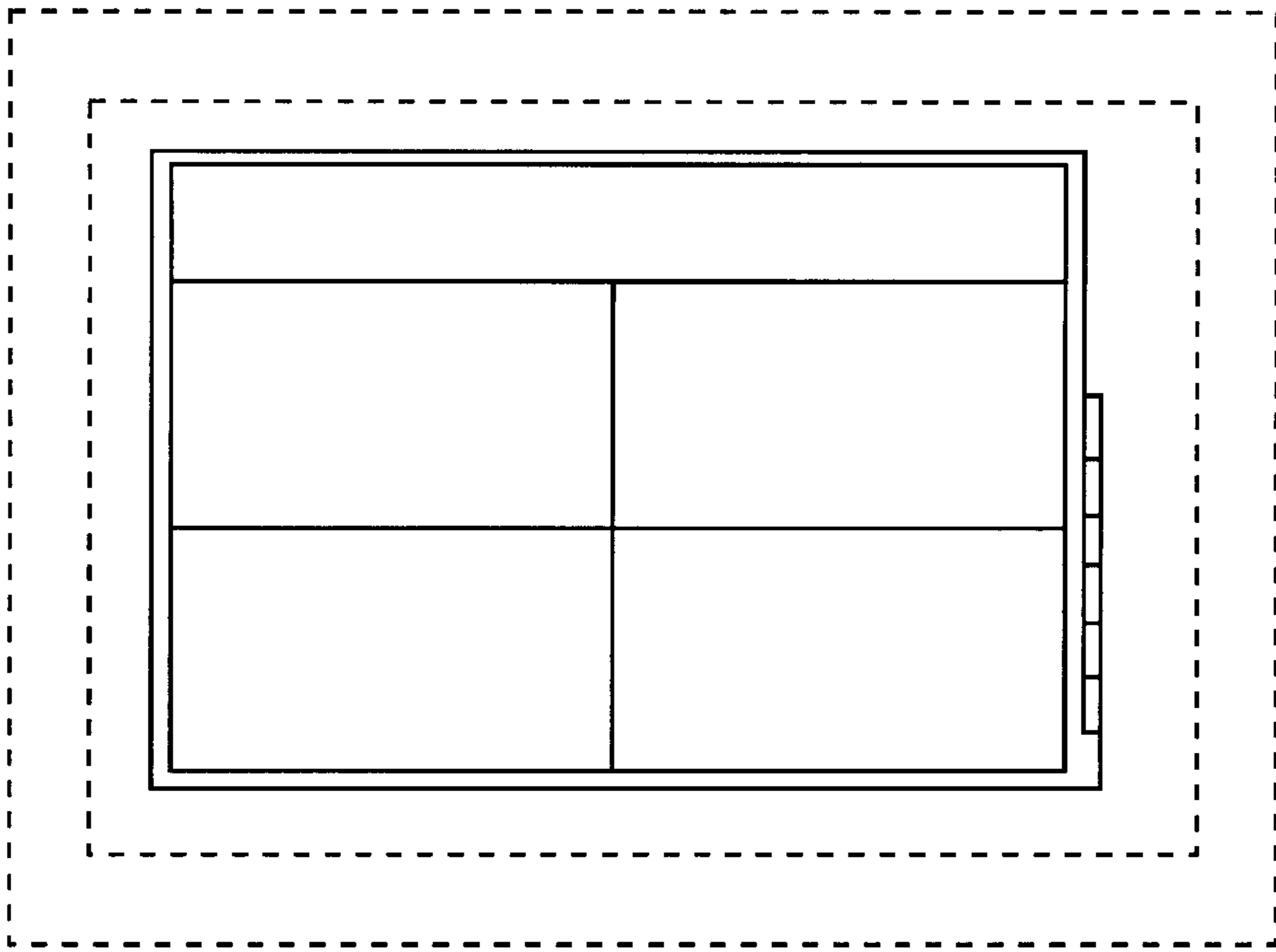


**FIG. 13**

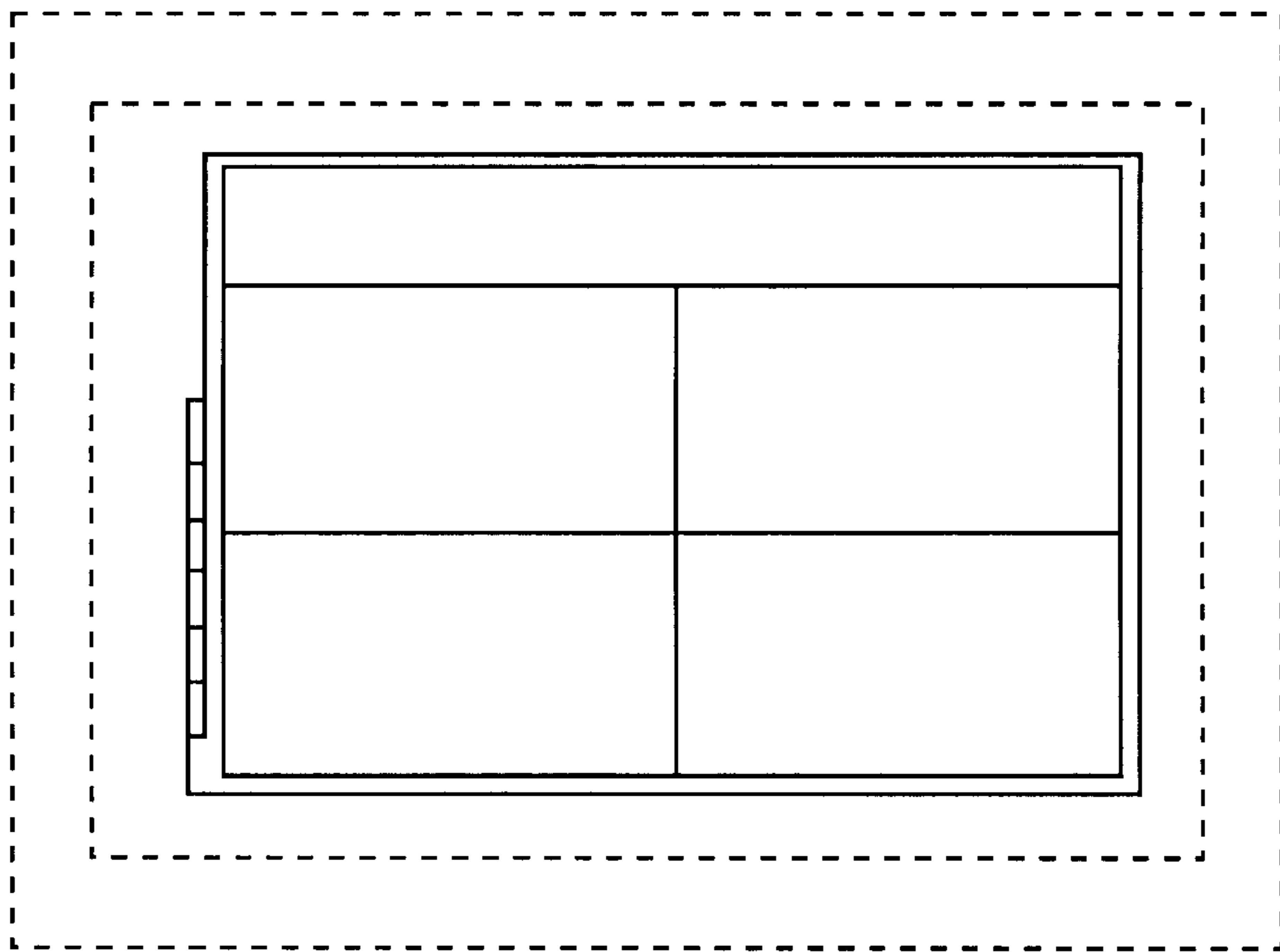


**FIG. 14**

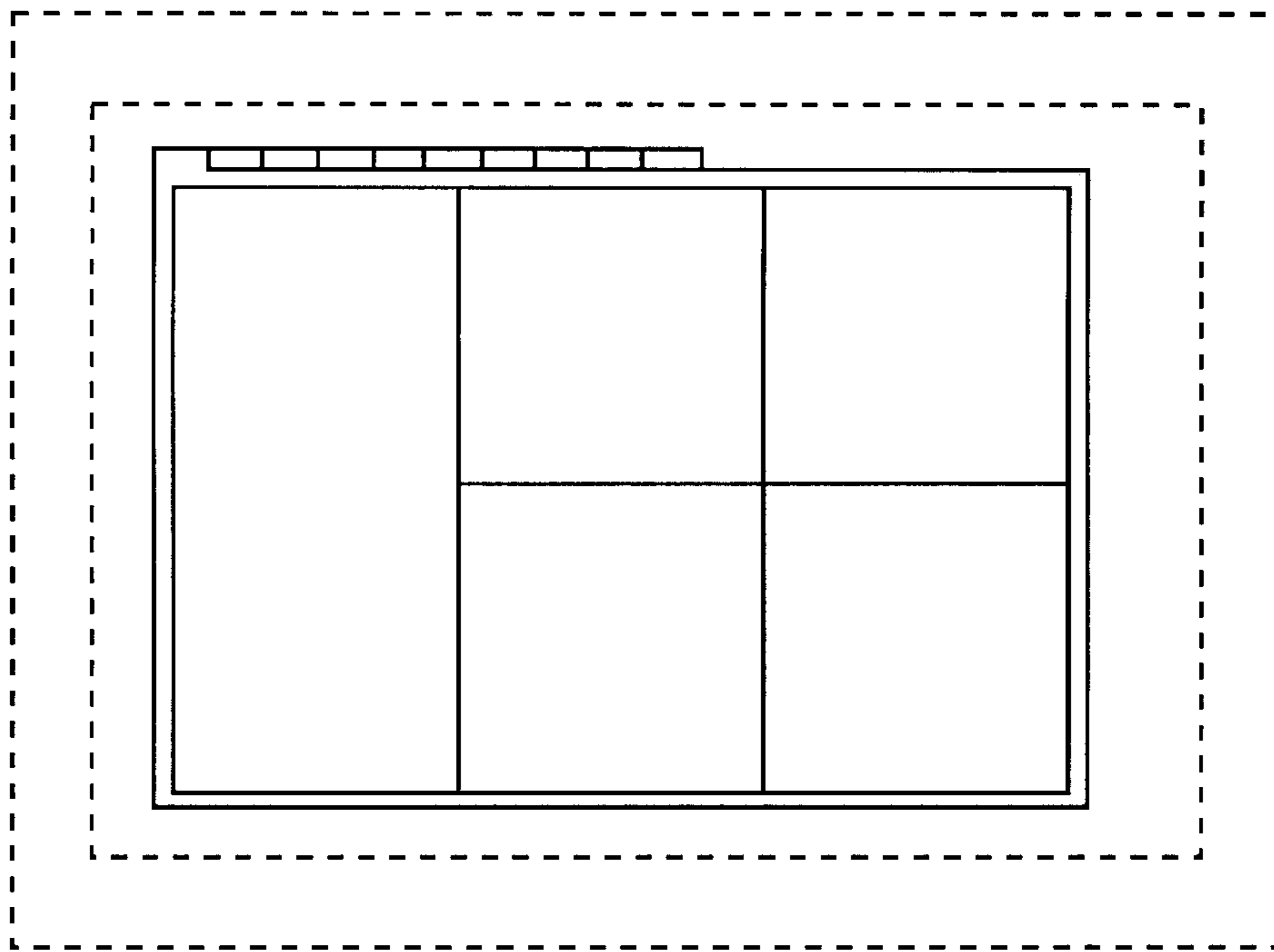




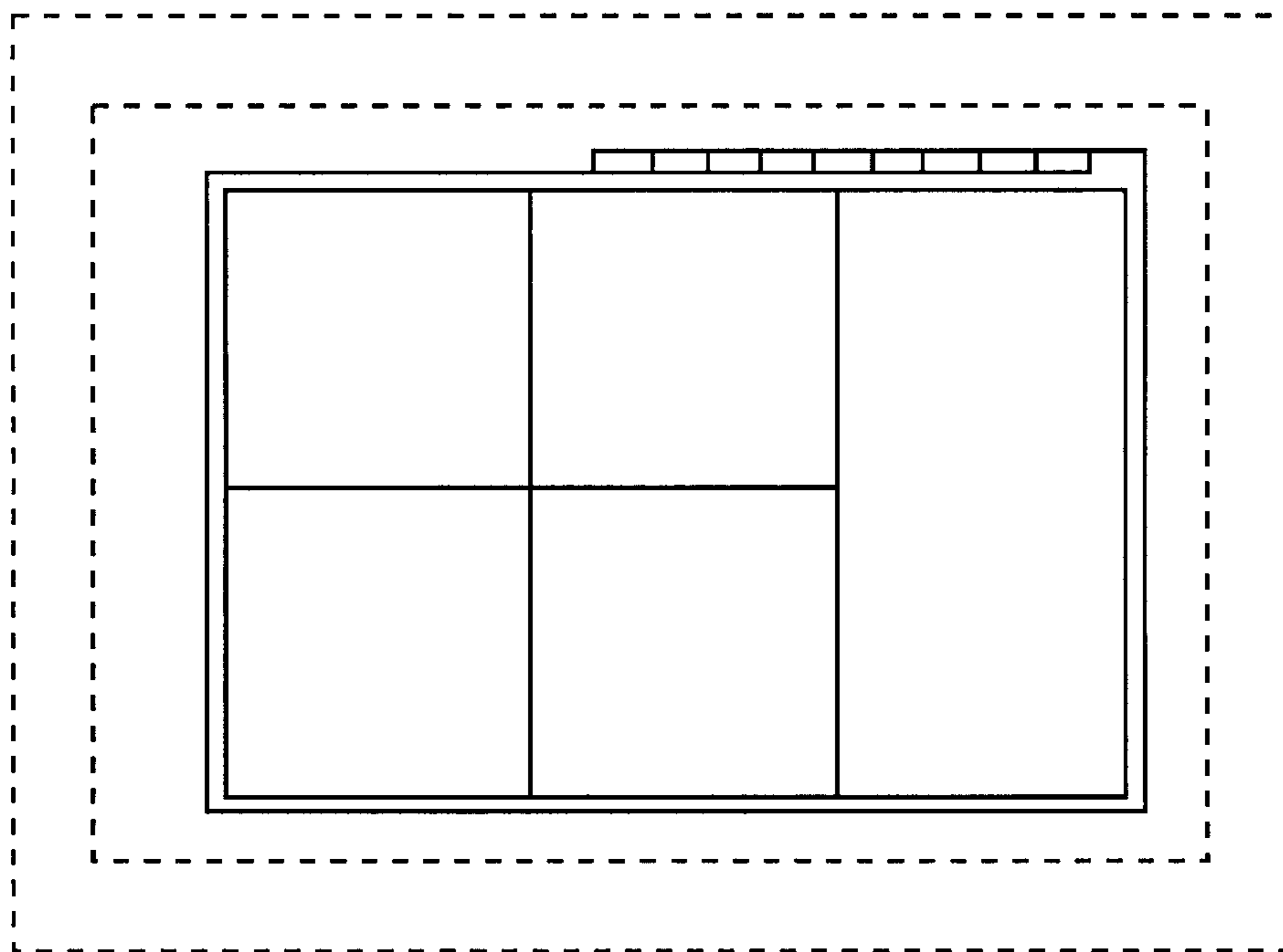
**FIG. 15**



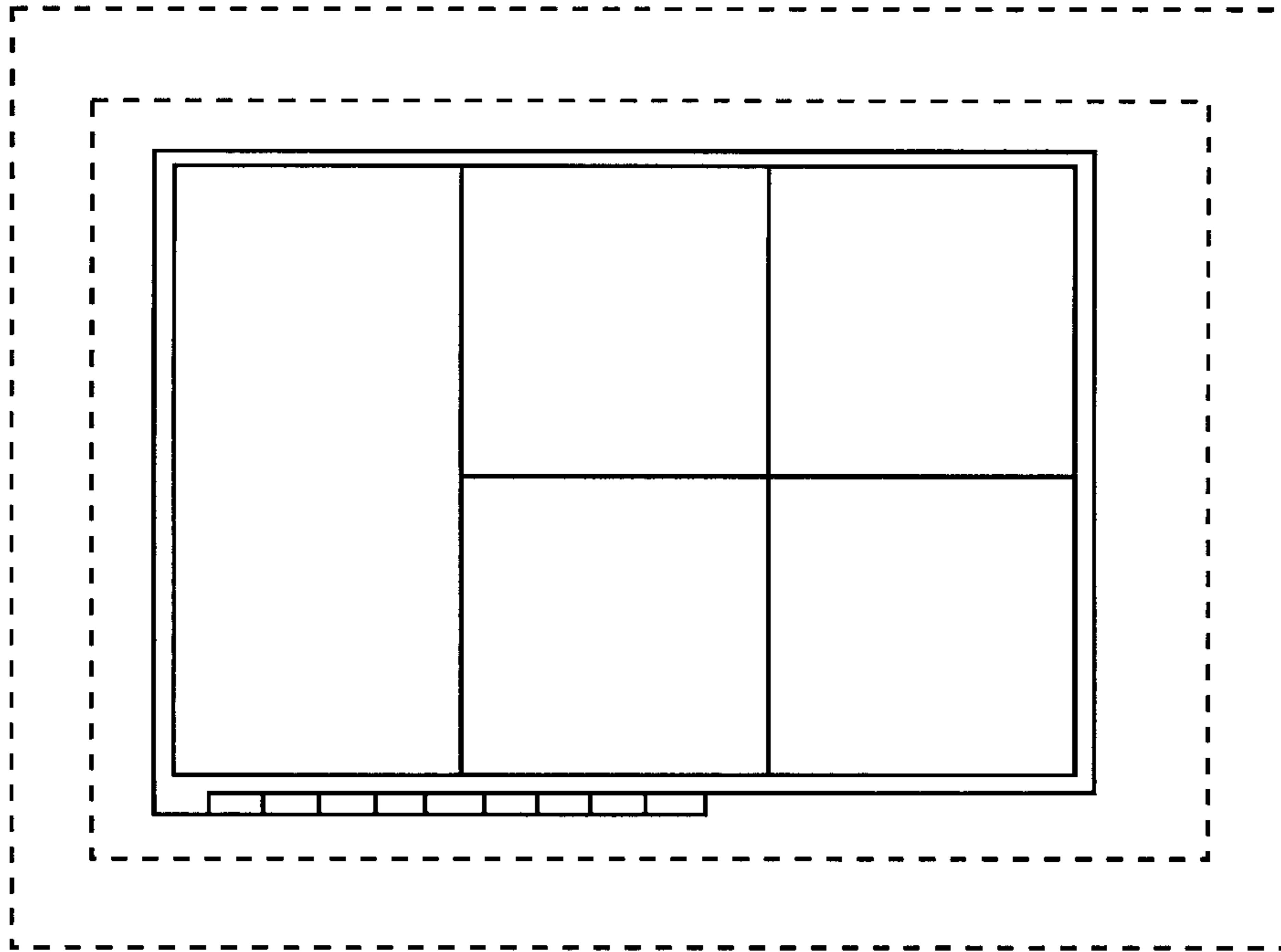
**FIG. 16**



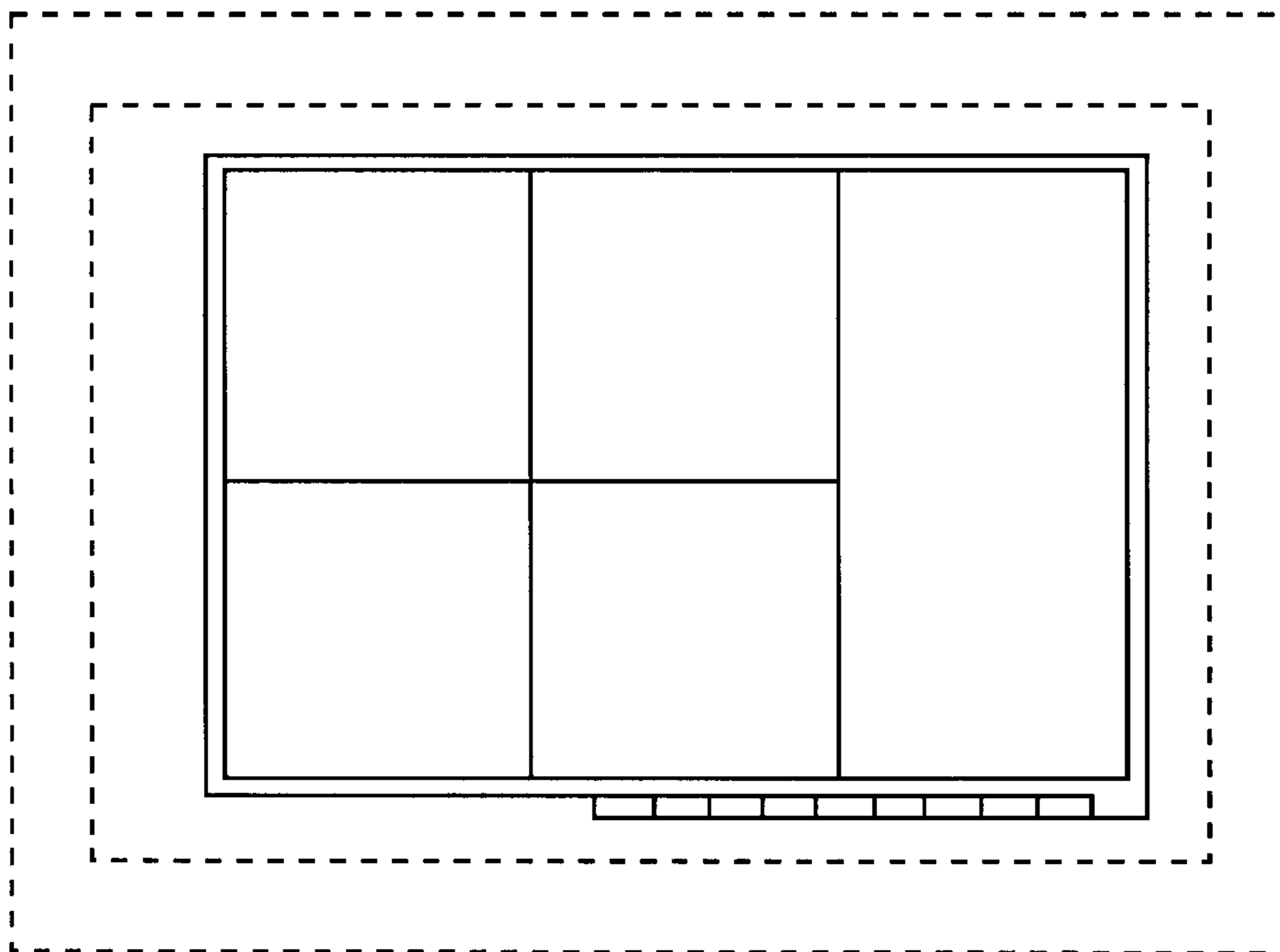
**FIG. 17**



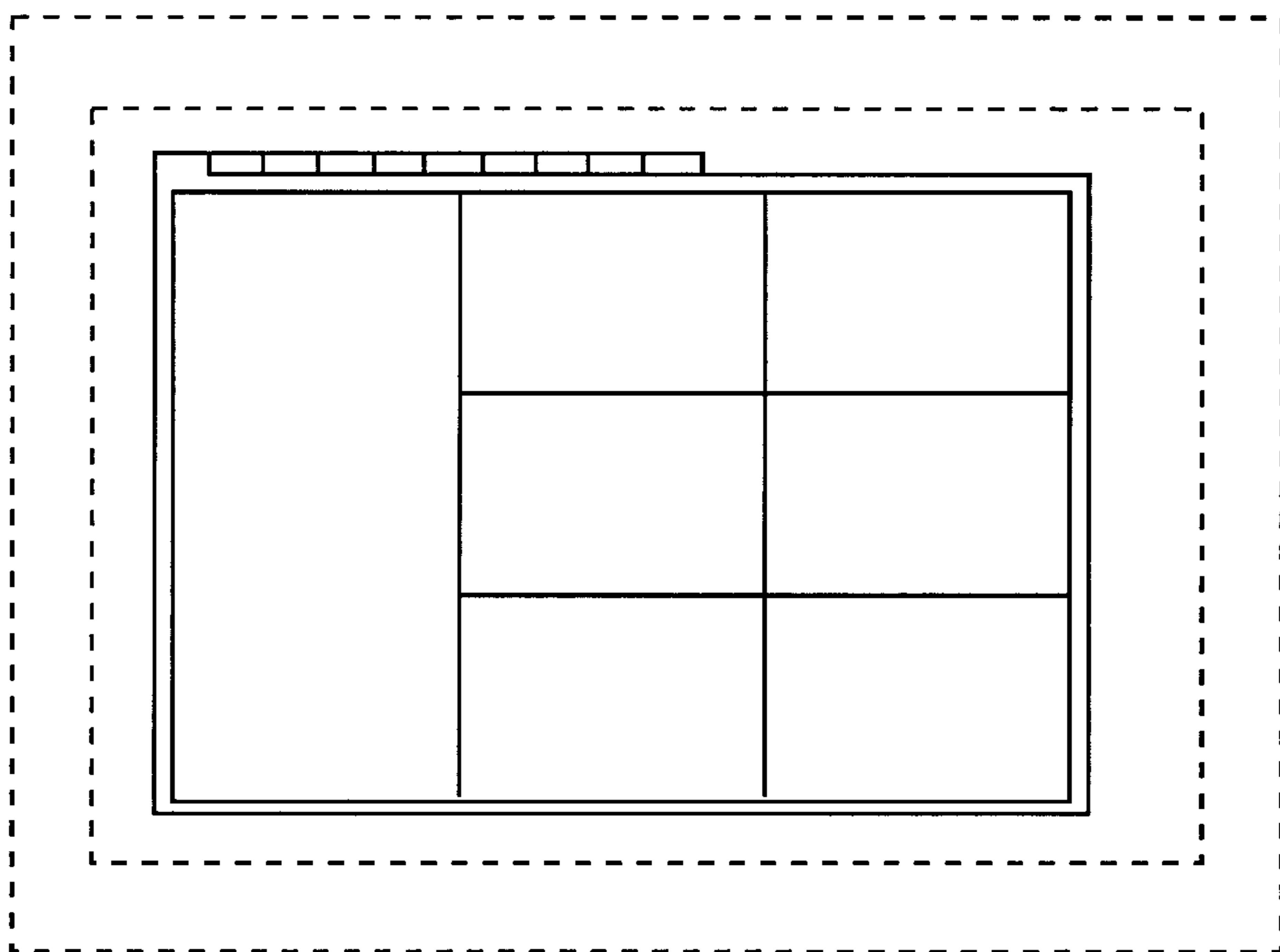
**FIG. 18**



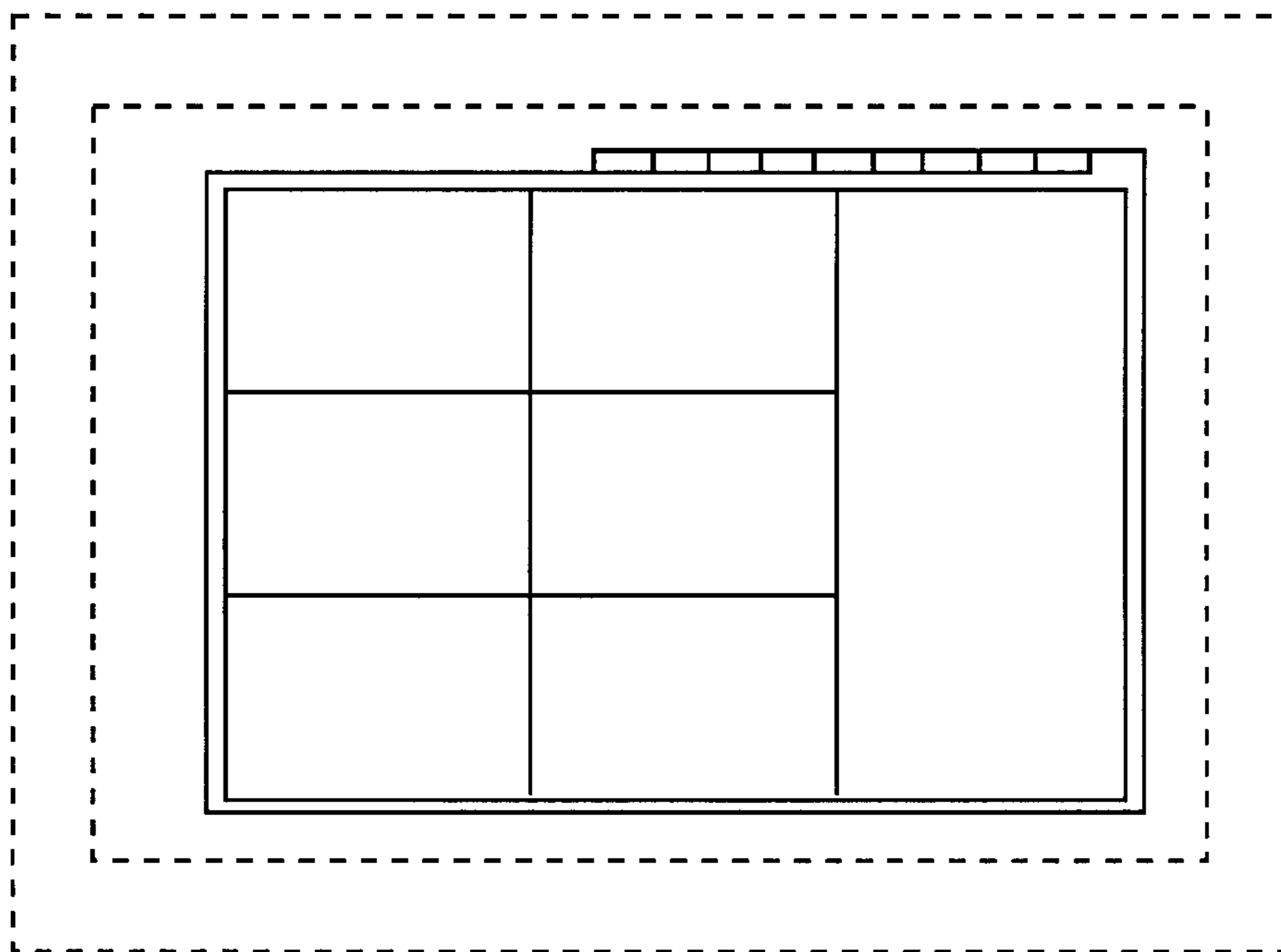
**FIG. 19**



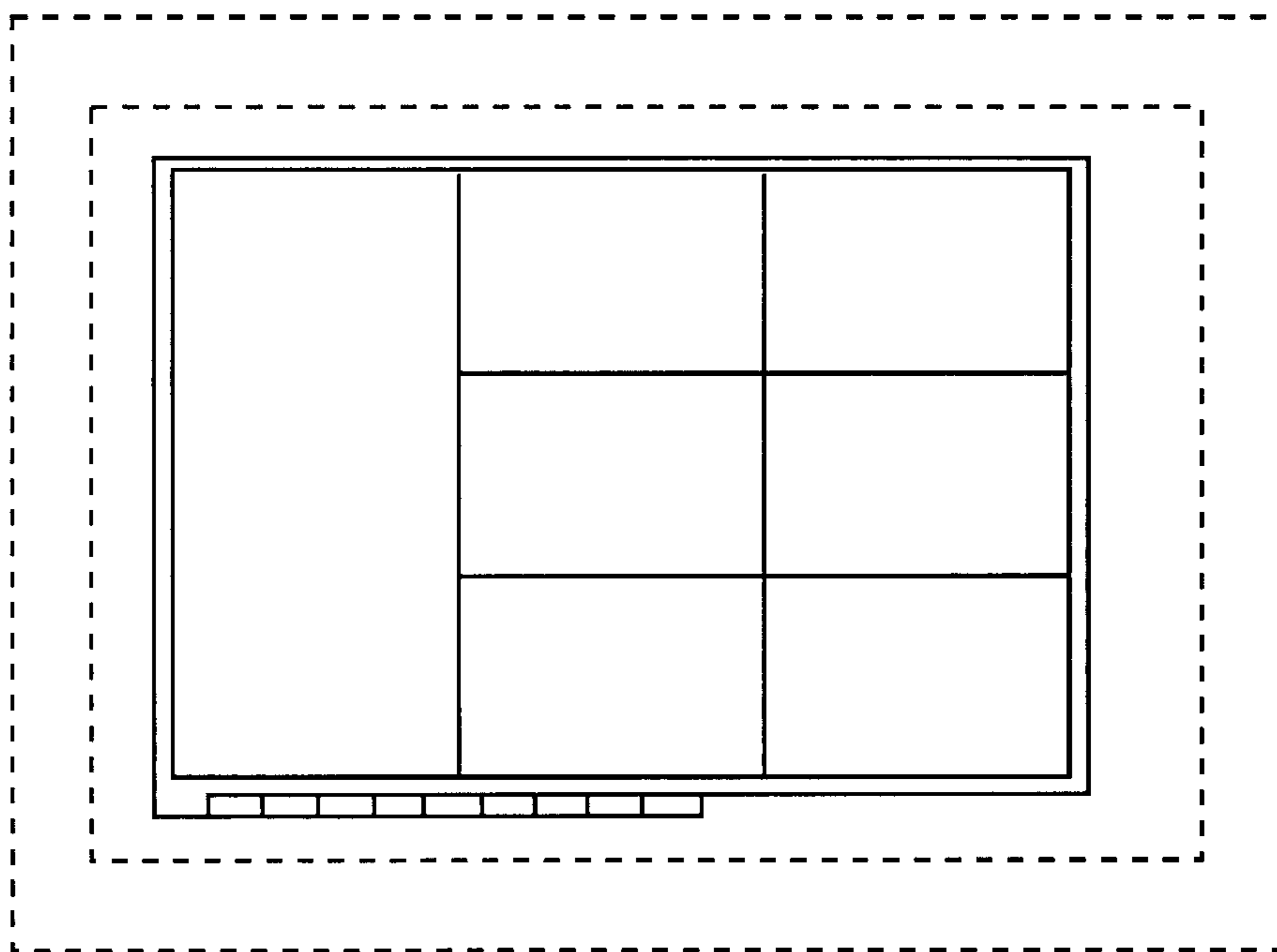
**FIG. 20**



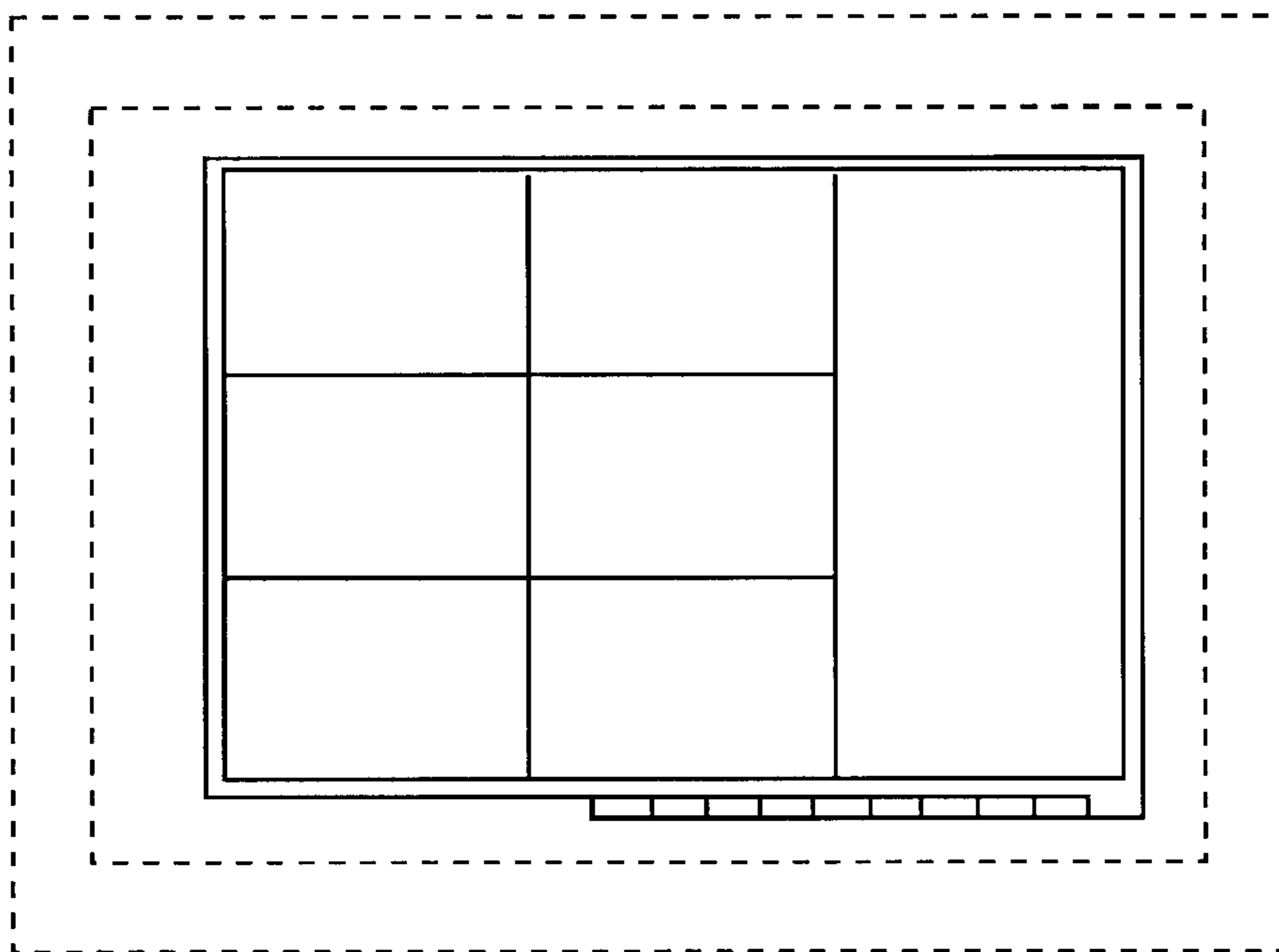
**FIG. 21**



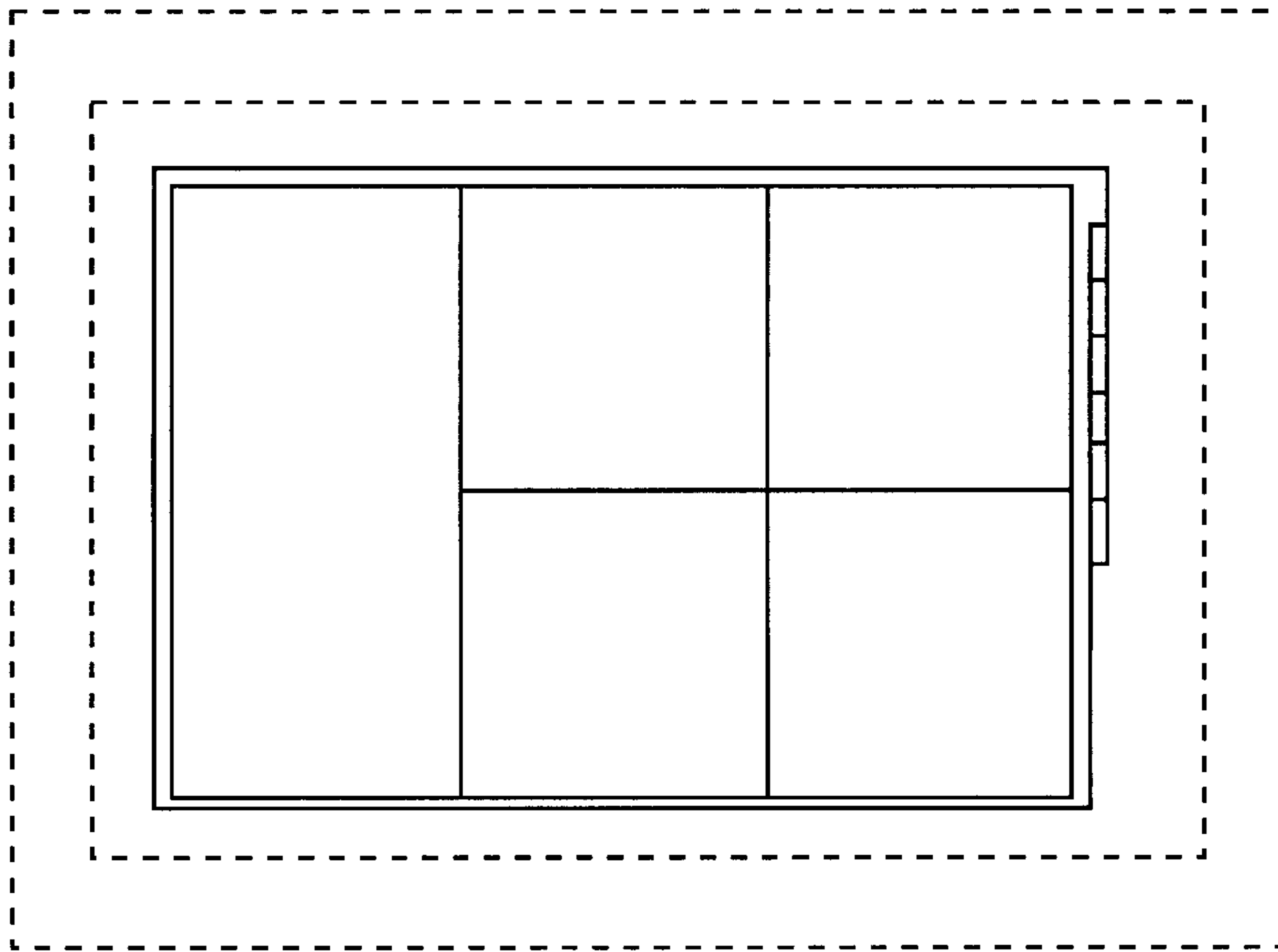
**FIG. 22**



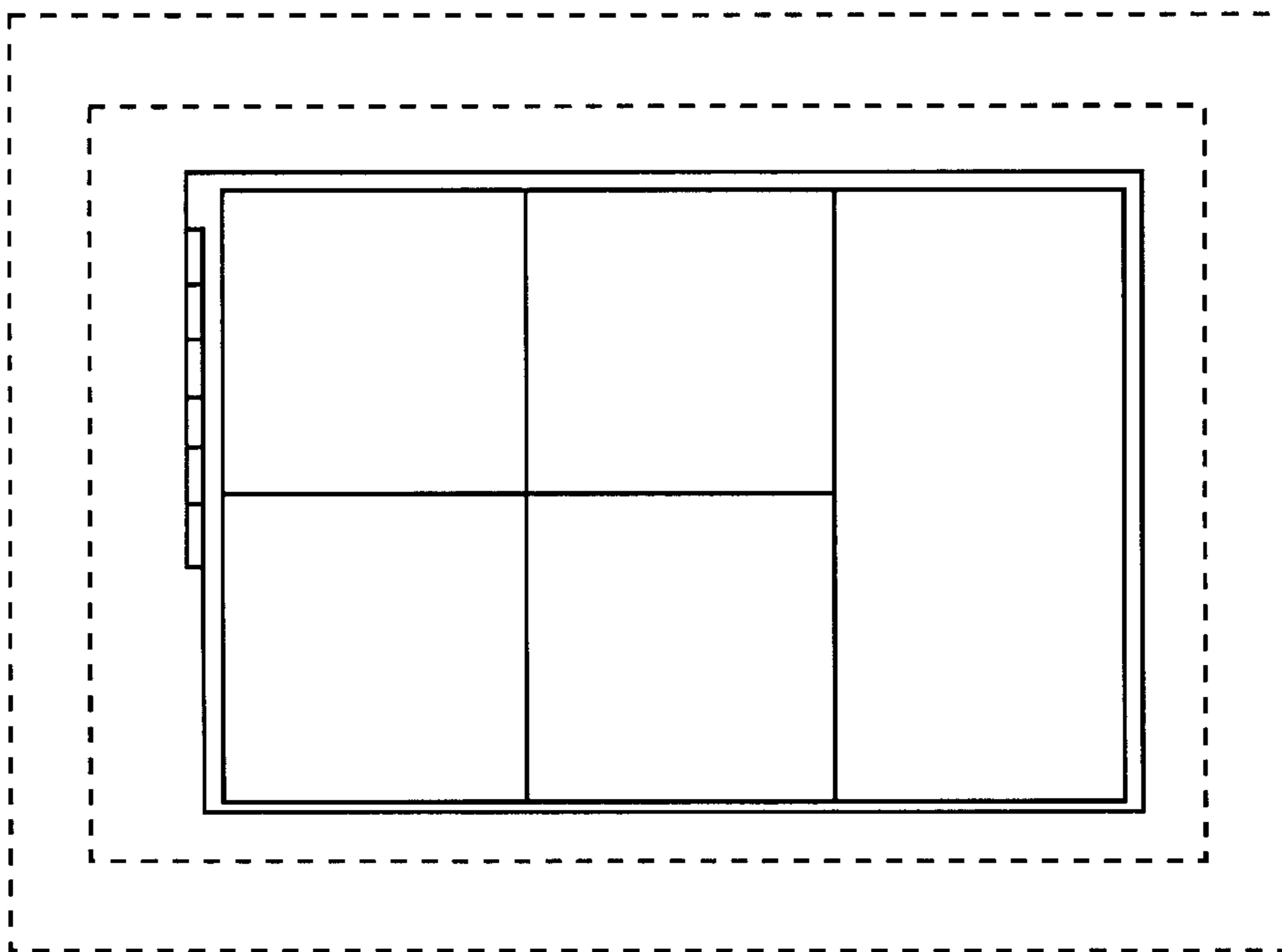
**FIG. 23**



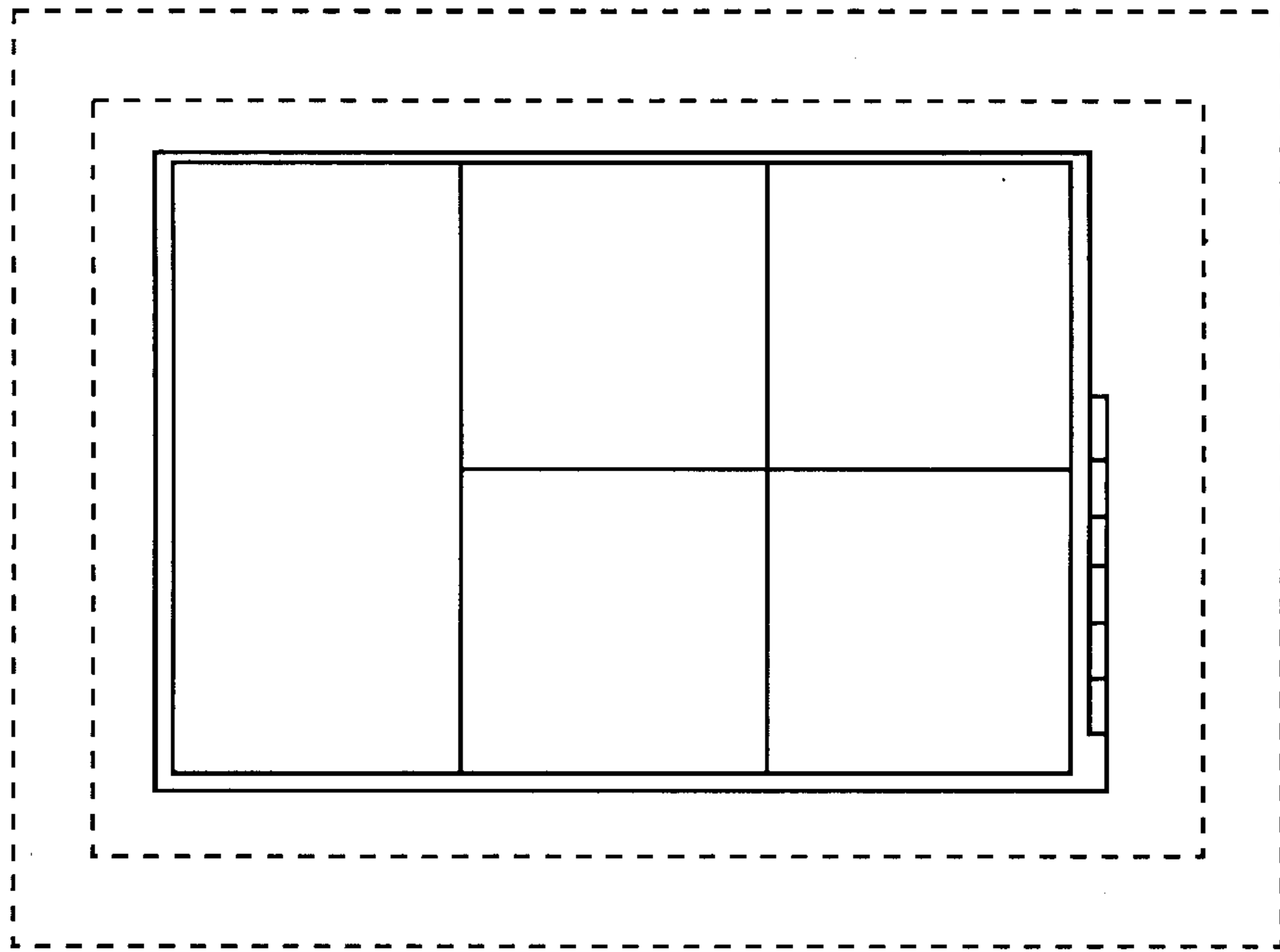
**FIG. 24**



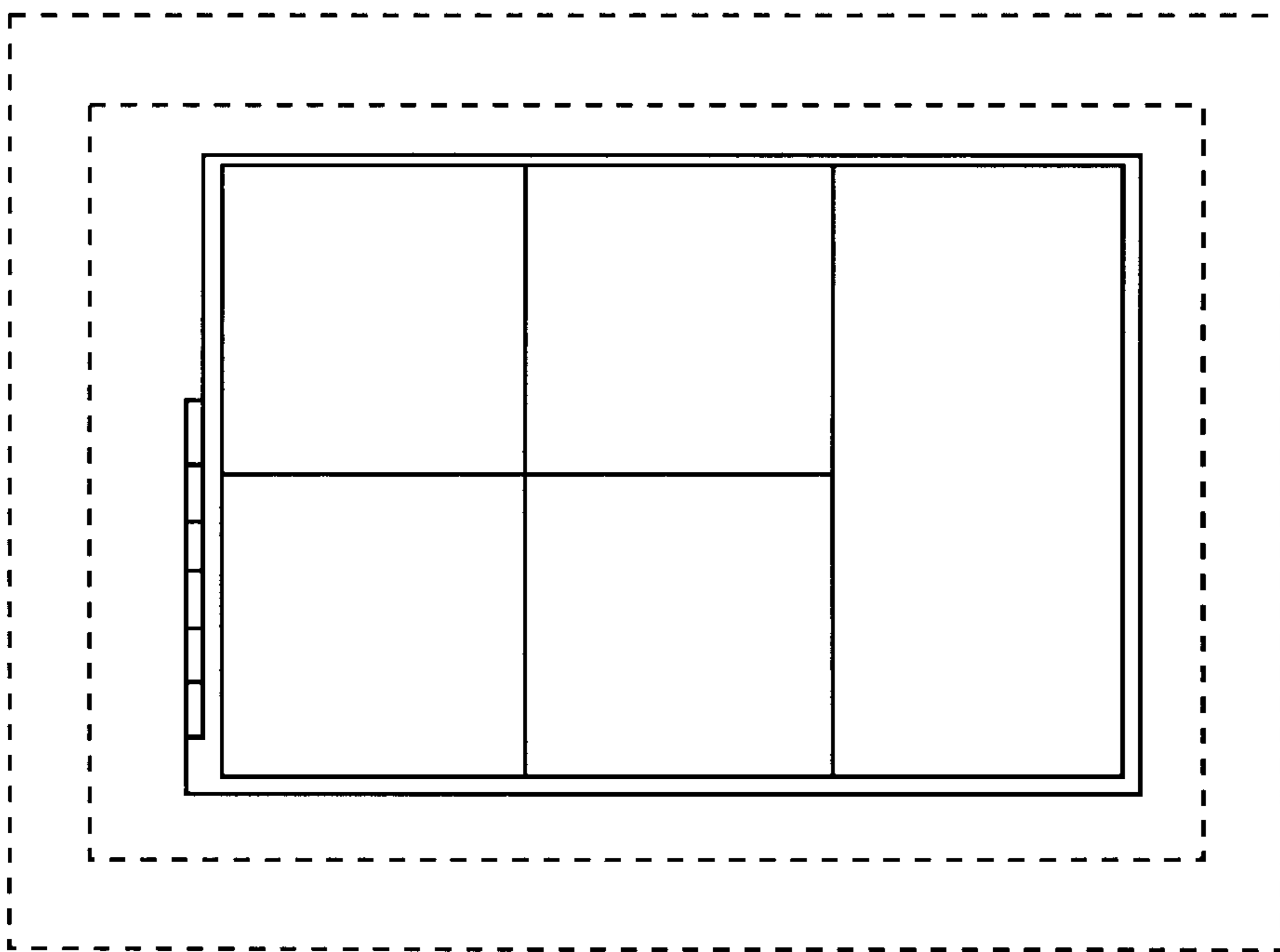
**FIG. 25**



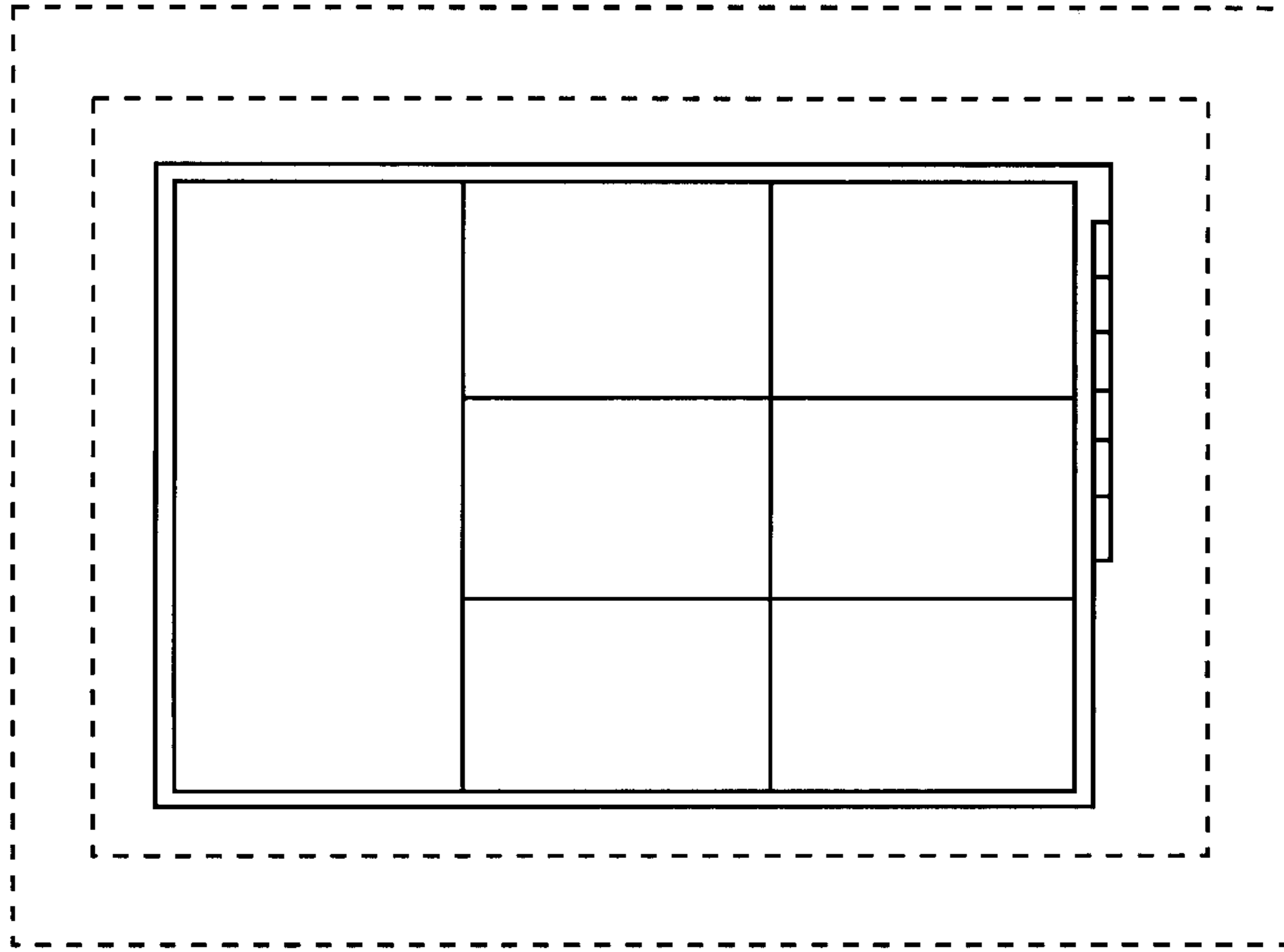
**FIG. 26**



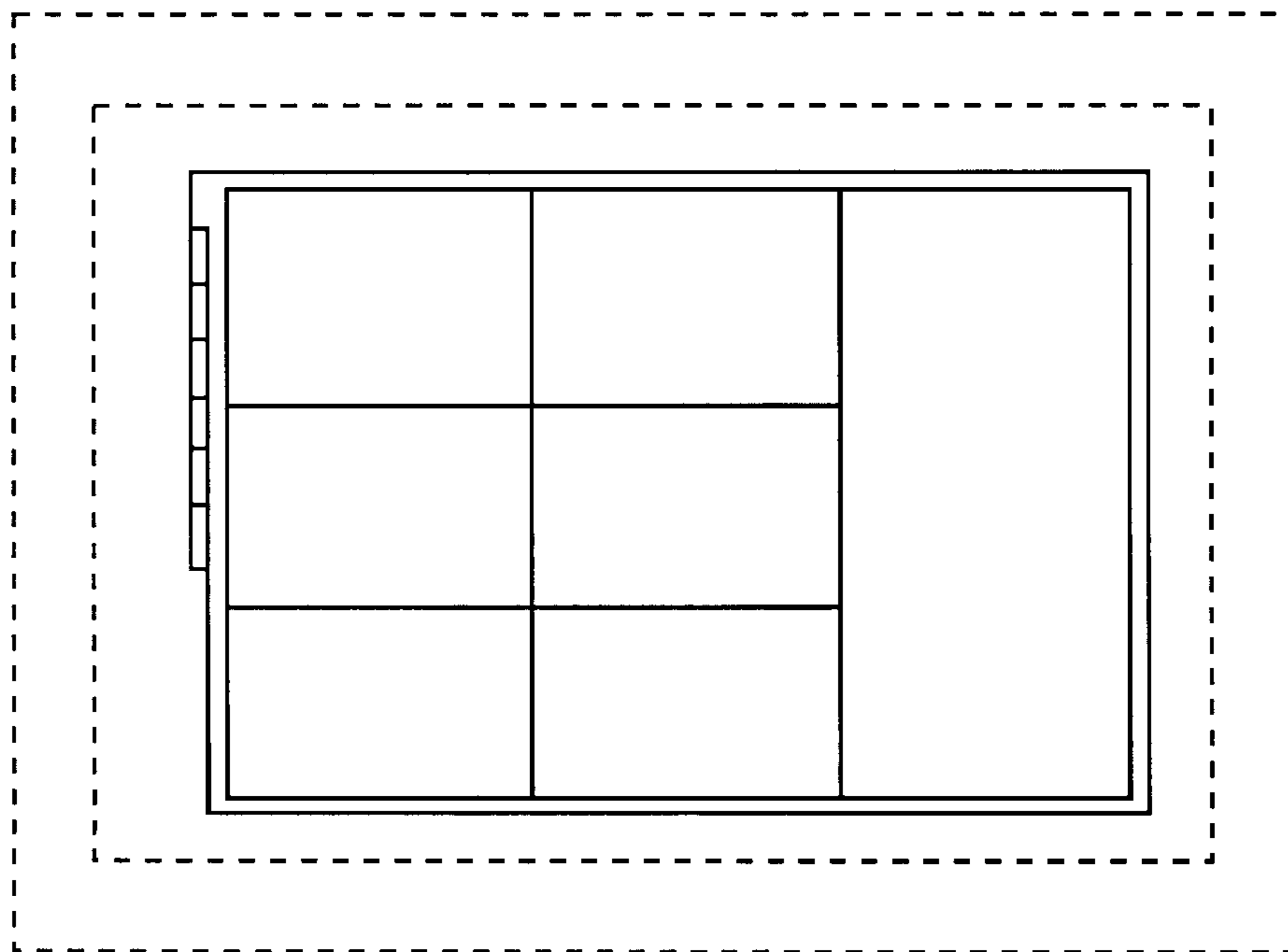
**FIG. 27**



**FIG. 28**

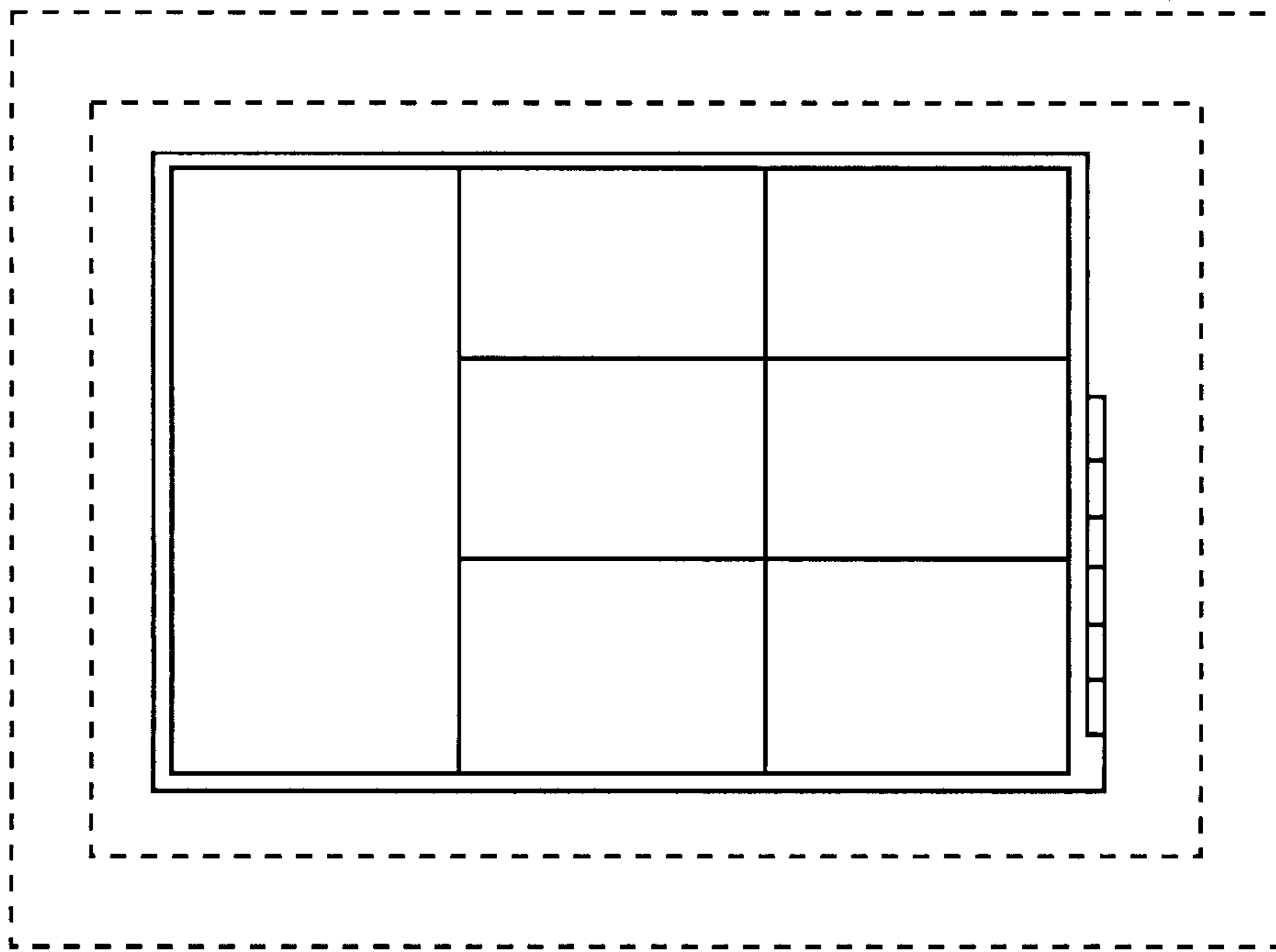


**FIG. 29**

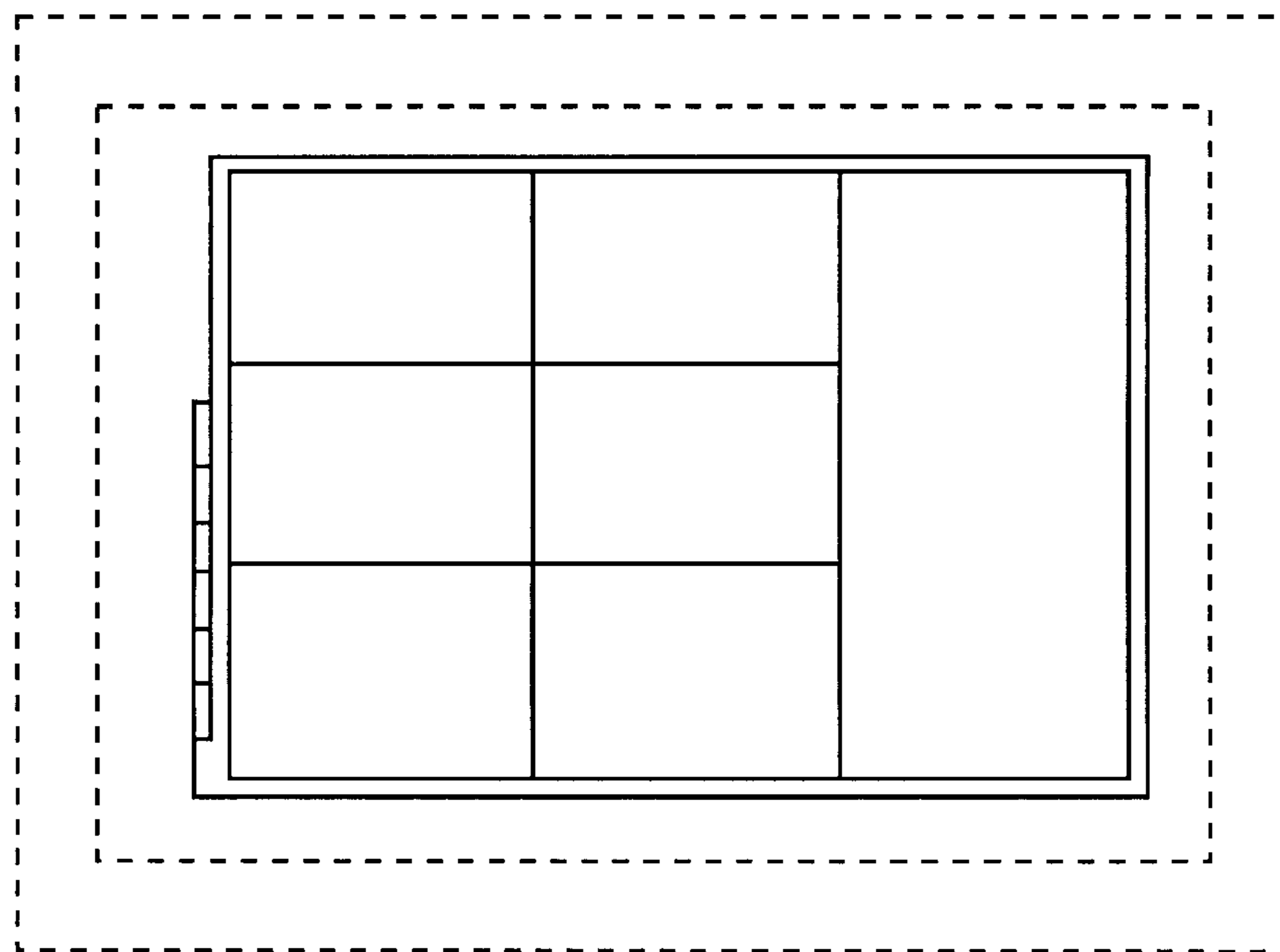


**FIG. 30**





**FIG. 31**



**FIG. 32**