



US00D427471S

United States Patent [19] Chen

[11] **Patent Number: Des. 427,471**
[45] **Date of Patent: ** Jul. 4, 2000**

[54] **TOWEL BAR**

[76] Inventor: **Lien-Fu Chen**, 9F-9, No. 144, Sec. 3,
Sun-Ming Road, Taichung, Taiwan

[**] Term: **14 Years**

[21] Appl. No.: **29/112,580**

[22] Filed: **Oct. 21, 1999**

[51] **LOC (7) Cl.** **06-04**

[52] **U.S. Cl.** **D6/549**

[58] **Field of Search** D6/549, 546; 211/13.1,
211/16, 86, 87, 105.1, 123, 181.1; 248/302,
309.1

[56] **References Cited**

U.S. PATENT DOCUMENTS

D. 259,753 7/1981 Fleischmann et al. D6/549
D. 357,841 5/1995 Lehn et al. D6/549

D. 361,460 8/1995 Warshawsky D6/549
D. 417,576 12/1999 Ming-Hsiao D6/549

Primary Examiner—Brian N. Vinson
Attorney, Agent, or Firm—Dougherty & Troxell

[57] **CLAIM**

The ornamental design for a towel bar, as shown and described.

DESCRIPTION

FIG. 1 is a front elevational view of a towel bar showing my new design;
FIG. 2 is a rear elevational view thereof;
FIG. 3 is a top plan view thereof;
FIG. 4 is a bottom plan view thereof;
FIG. 5 is a left side elevational view thereof;
FIG. 6 is a right side elevational view thereof; and,
FIG. 7 is a perspective view thereof.

1 Claim, 4 Drawing Sheets

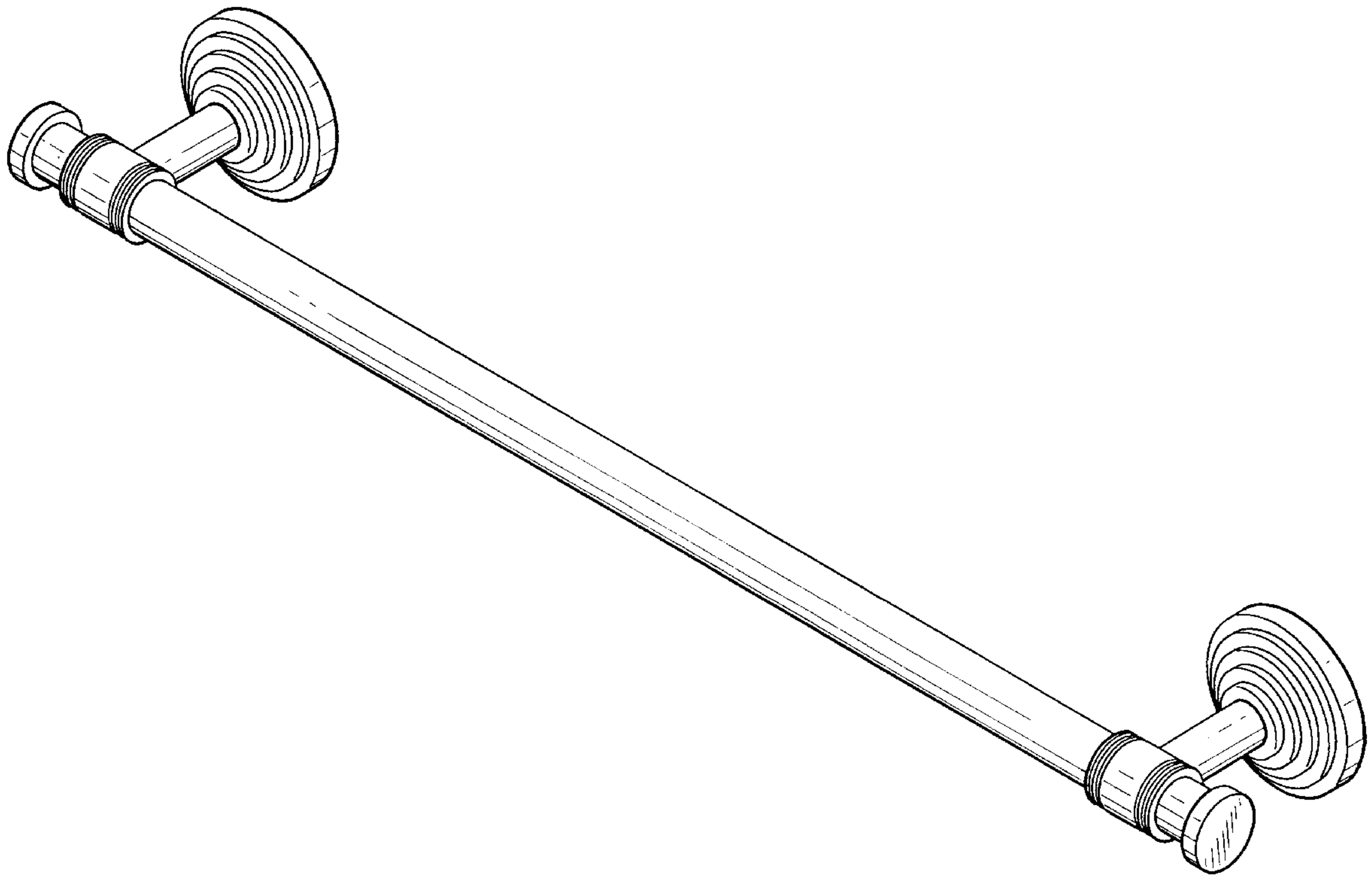

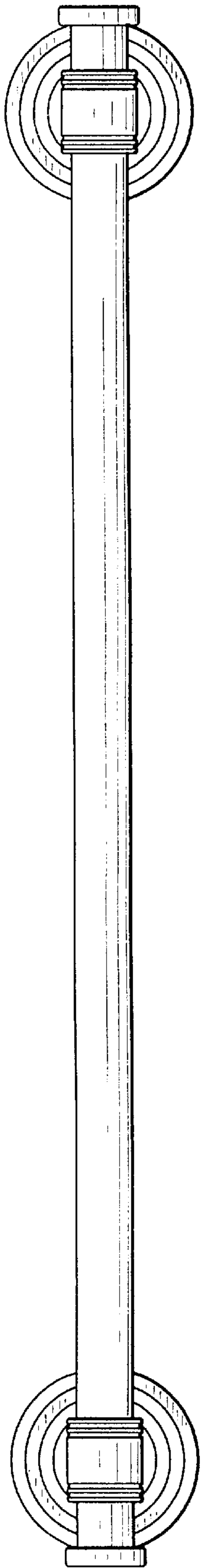

FIG. 1

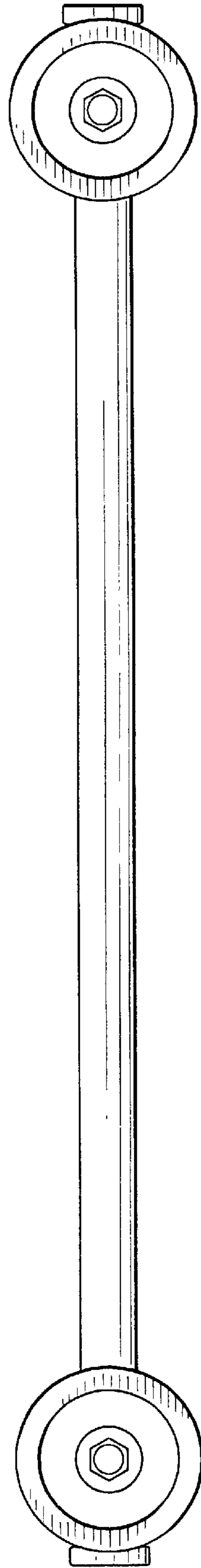

FIG. 2

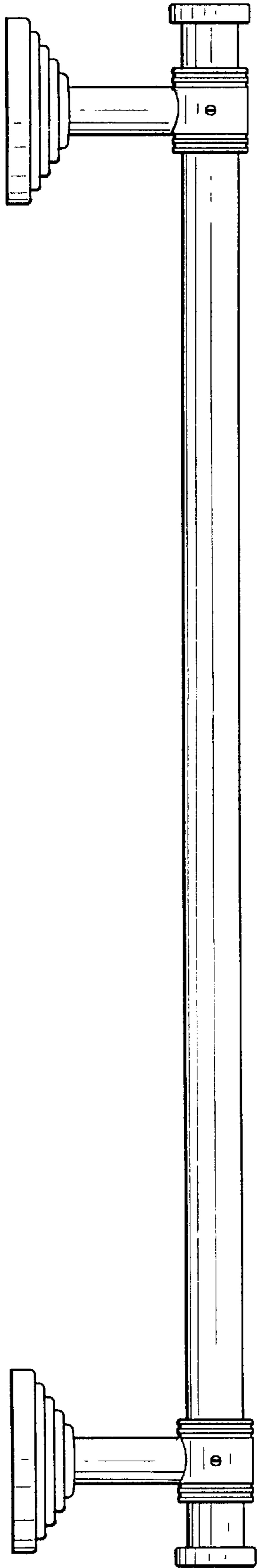

FIG.3

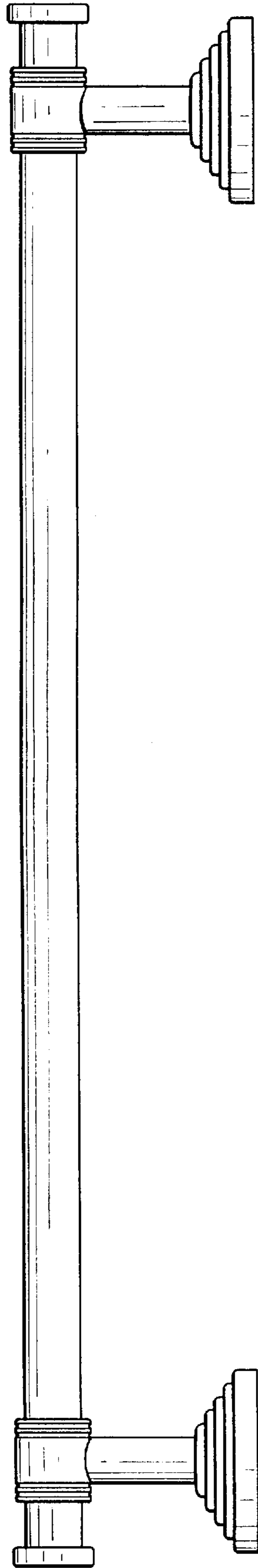

FIG.4

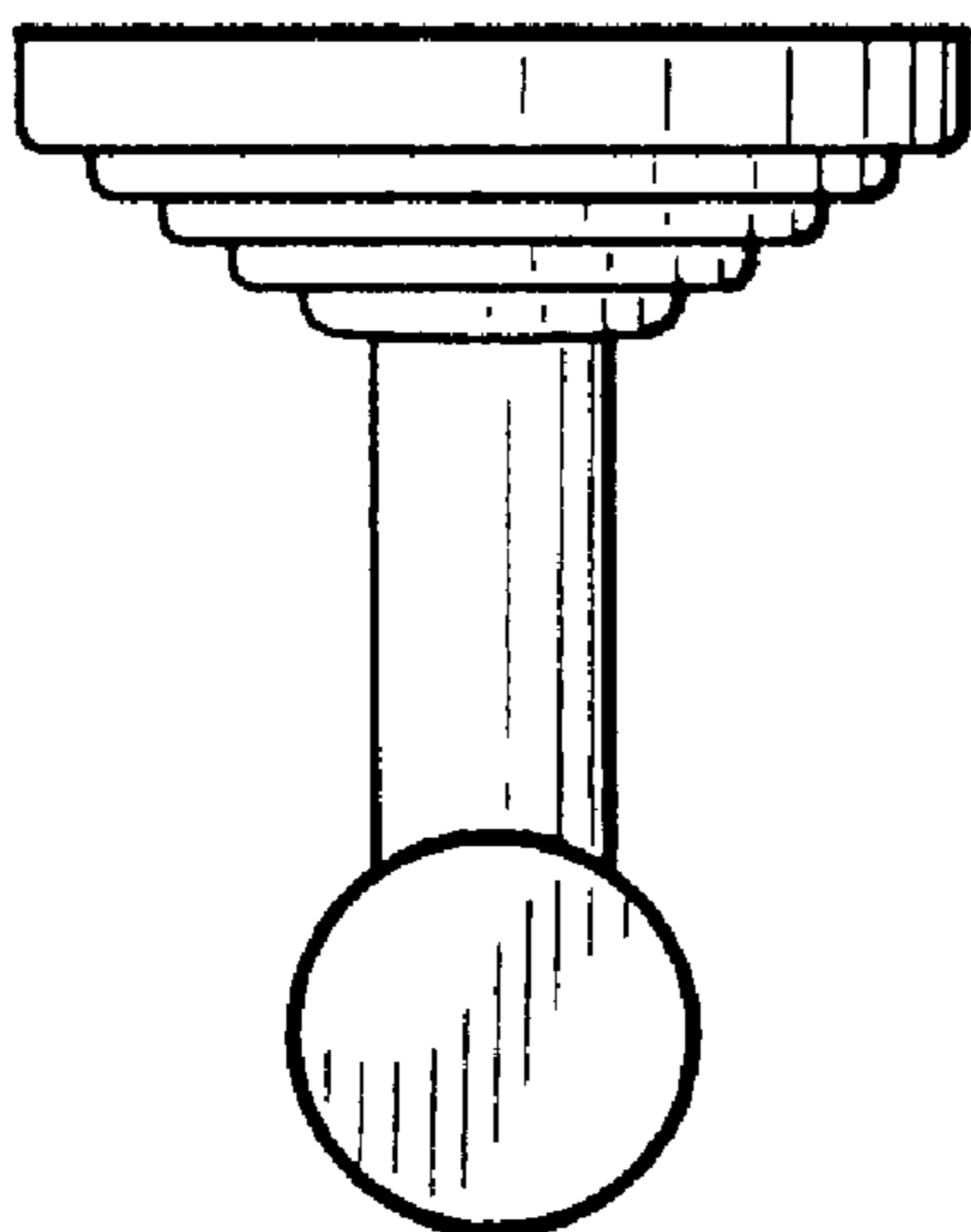

FIG. 6

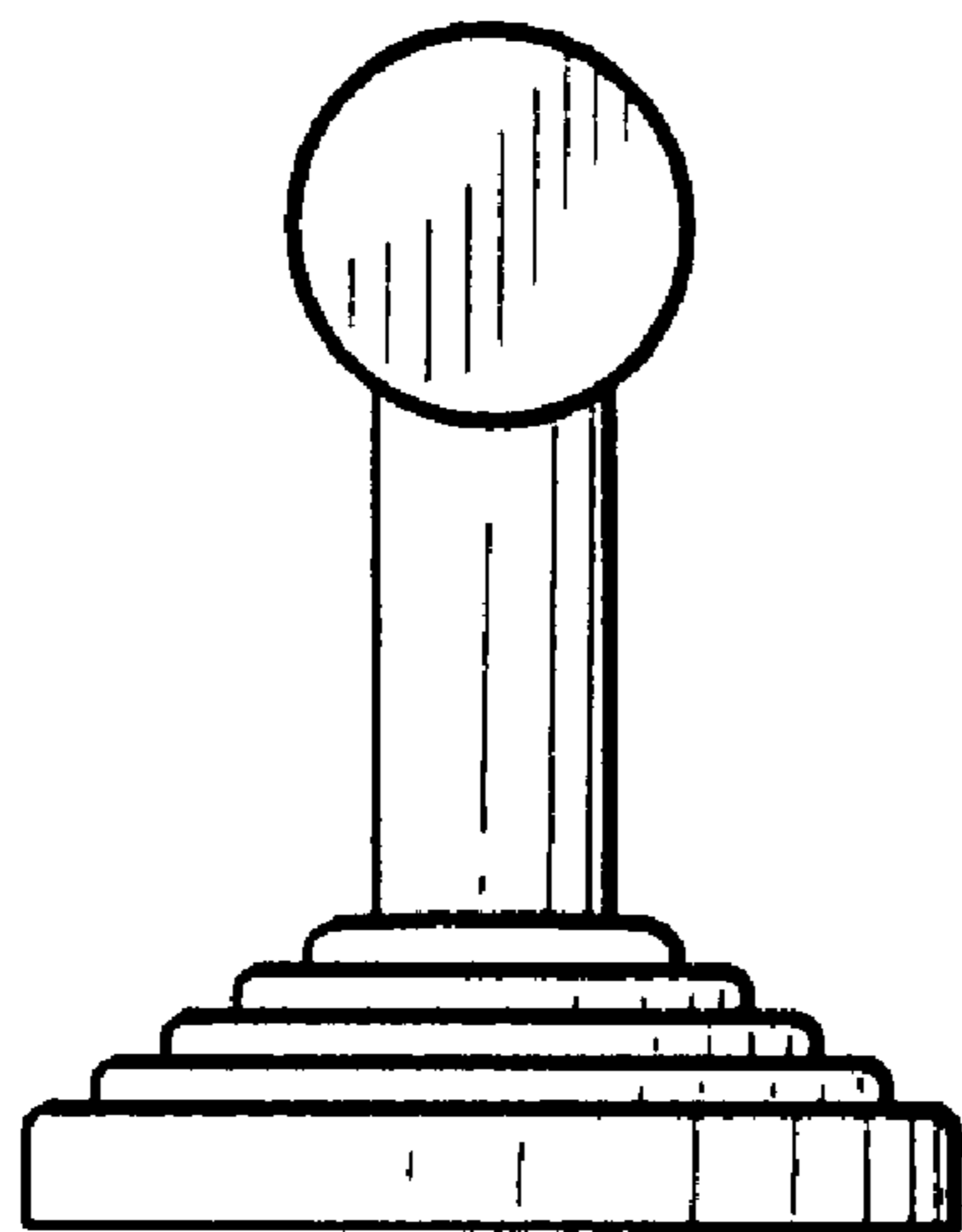

FIG. 5

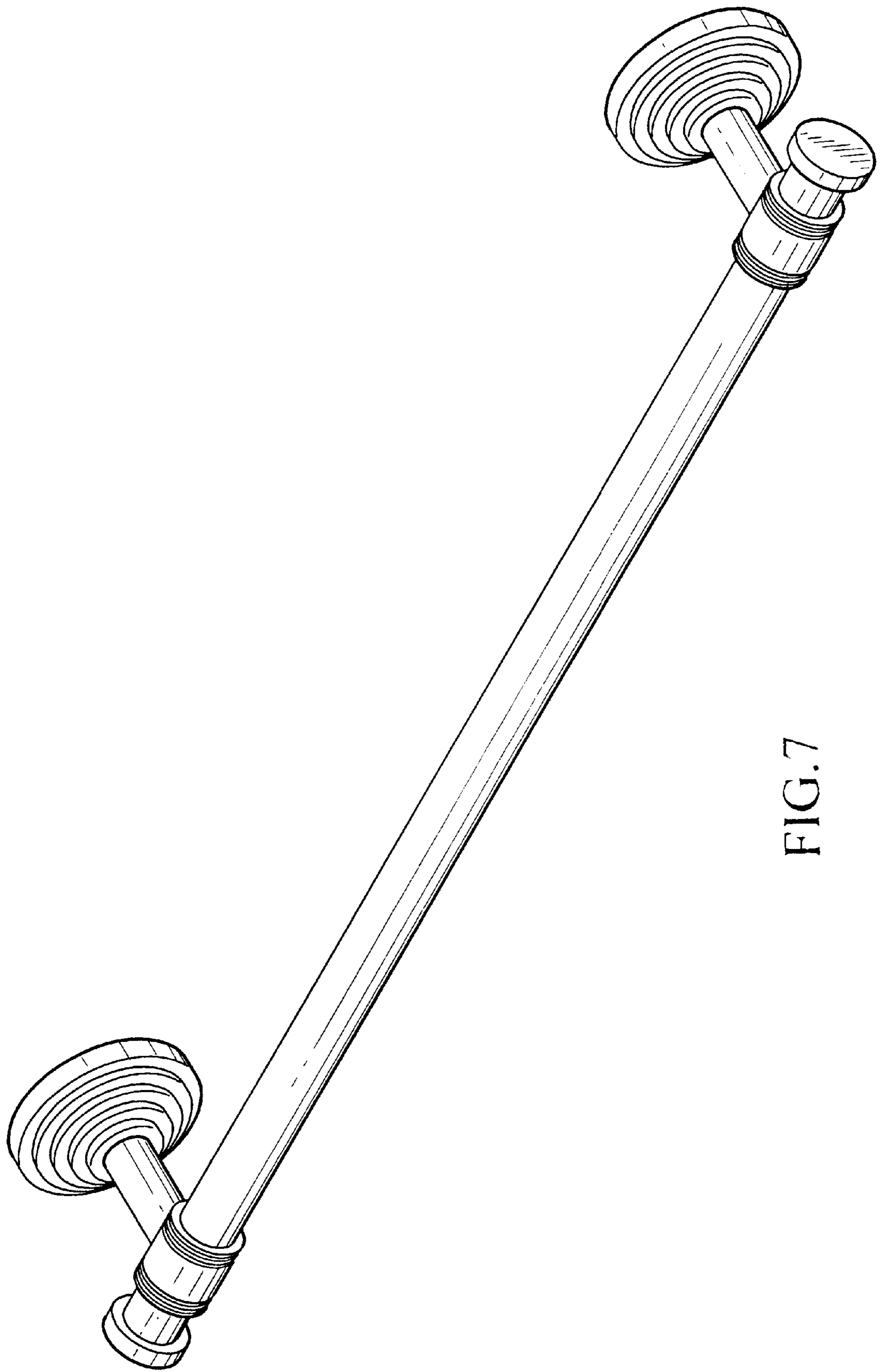

FIG. 7