



US00D427403S

United States Patent [19]
Gudefin

[11] **Patent Number: Des. 427,403**

[45] **Date of Patent: ** Jun. 27, 2000**

[54] **IRON**

[75] Inventor: **Jacques Gudefin**, Saint Priest, France

[73] Assignee: **Calor S.A.**, Lyons, France

[**] Term: **14 Years**

[21] Appl. No.: **29/090,279**

[22] Filed: **Jul. 6, 1998**

[30] **Foreign Application Priority Data**

Jan. 7, 1998 [XH] Hague Agreement DMA/003973

[51] **LOC (7) Cl.** **07-05**

[52] **U.S. Cl.** **D32/70**

[58] **Field of Search** D32/68, 70; 219/245,
219/246; 38/69, 74, 77.1, 77.2, 77.3, 77.4,
77.5, 77.9, 79, 88

[56] **References Cited**

U.S. PATENT DOCUMENTS

D. 366,544	1/1996	Choi	D32/70
D. 370,104	5/1996	Gudefin	D32/70
D. 373,872	9/1996	Sham	D32/70
D. 374,527	10/1996	Gudefin	D32/68

D. 379,702	6/1997	Gudefin	D32/73
D. 388,576	12/1997	Gudefin	D32/73
D. 389,622	1/1998	Dziersk	D32/70
D. 393,509	4/1998	Gudefin	D32/70
D. 402,779	12/1998	Gudefin	D32/70
D. 406,933	3/1999	Leverrier	D32/70
5,512,728	4/1996	Jalbert	38/79
5,922,228	7/1999	Hall et al.	219/245

Primary Examiner—Susan J. Lucas
Assistant Examiner—Cynthia E. Ramirez
Attorney, Agent, or Firm—Greenblum & Bernstein, P.L.O.

[57] **CLAIM**

I claim the ornamental design for an iron, as shown and described.

DESCRIPTION

FIG. 1 is a front elevation view of my new design;
FIG. 2 is a rear elevation view thereof;
FIG. 3 is a top view thereof;
FIG. 4 is a bottom view thereof;
FIG. 5 is a side elevation view from the left of FIG. 1;
FIG. 6 is a side elevation view from the right of FIG. 1; and,
FIG. 7 is a perspective view thereof from the front and from the left.

1 Claim, 7 Drawing Sheets

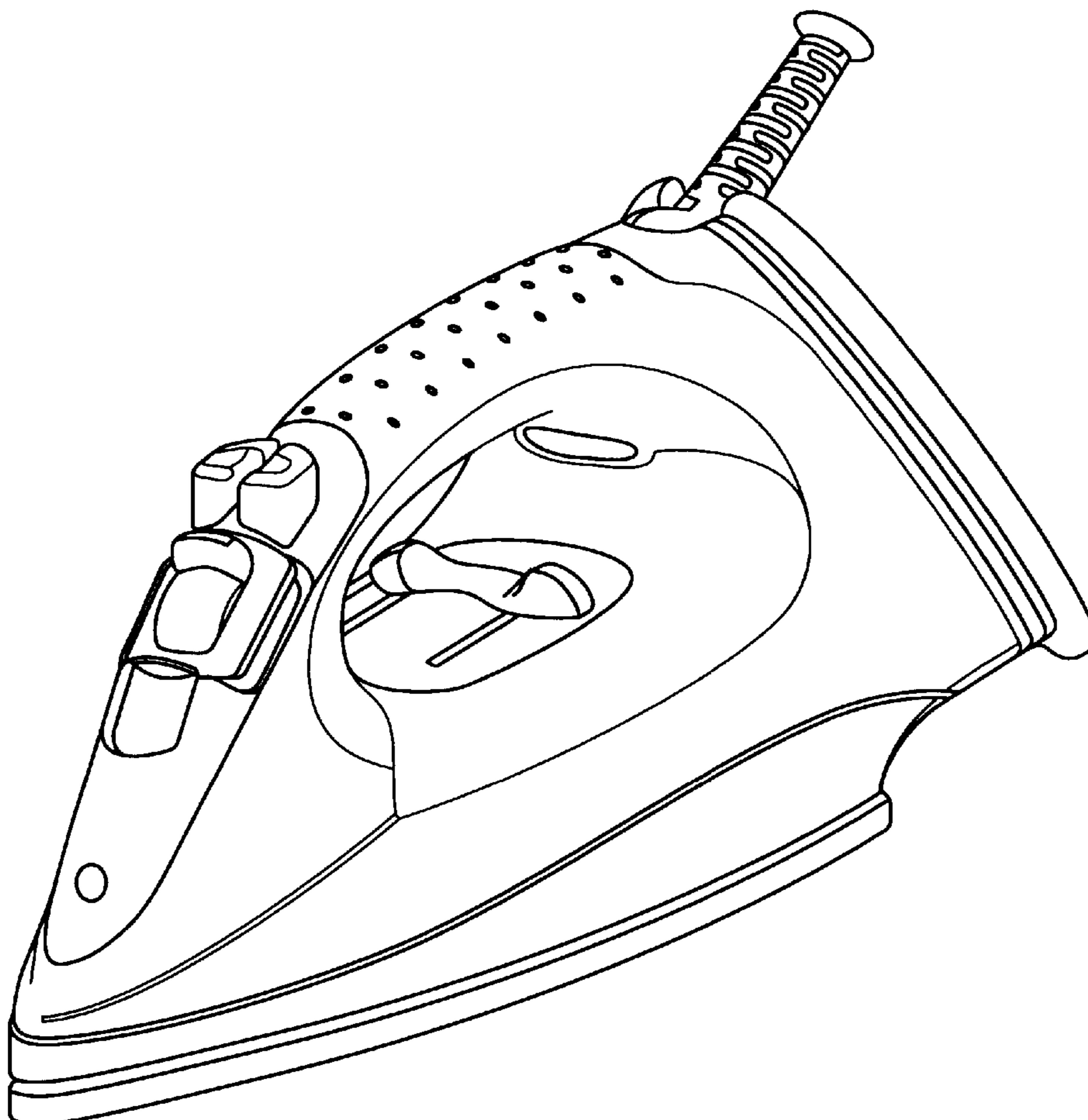

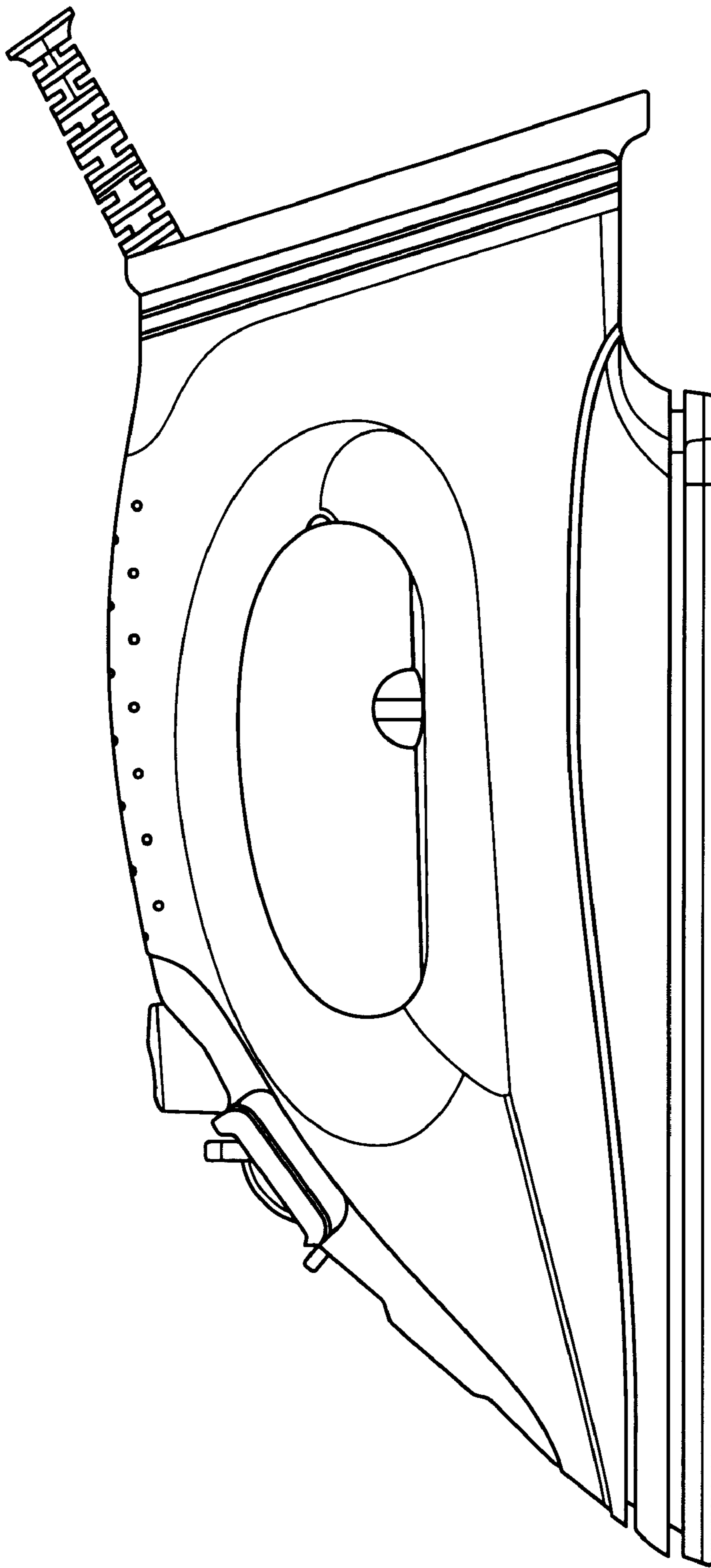

FIG. 1

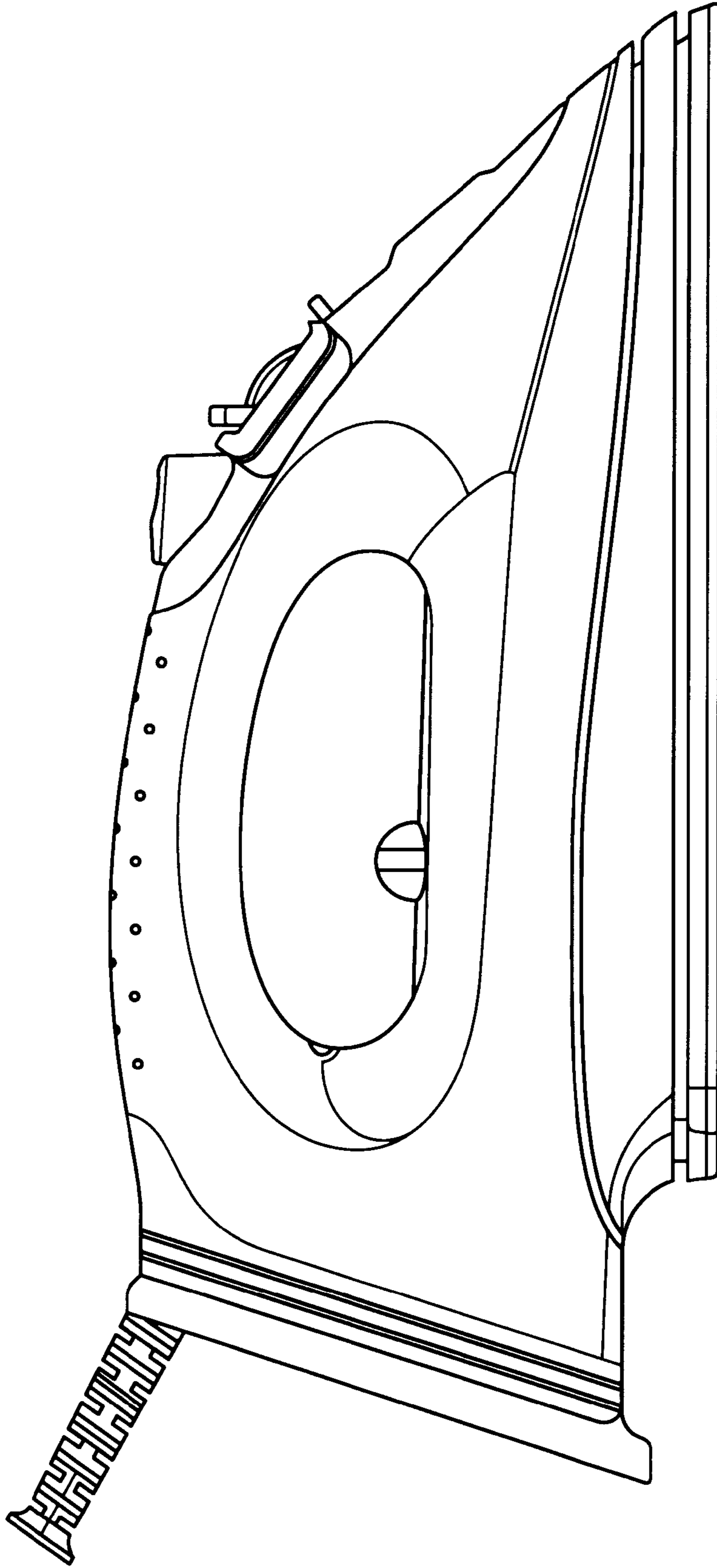

FIG. 2

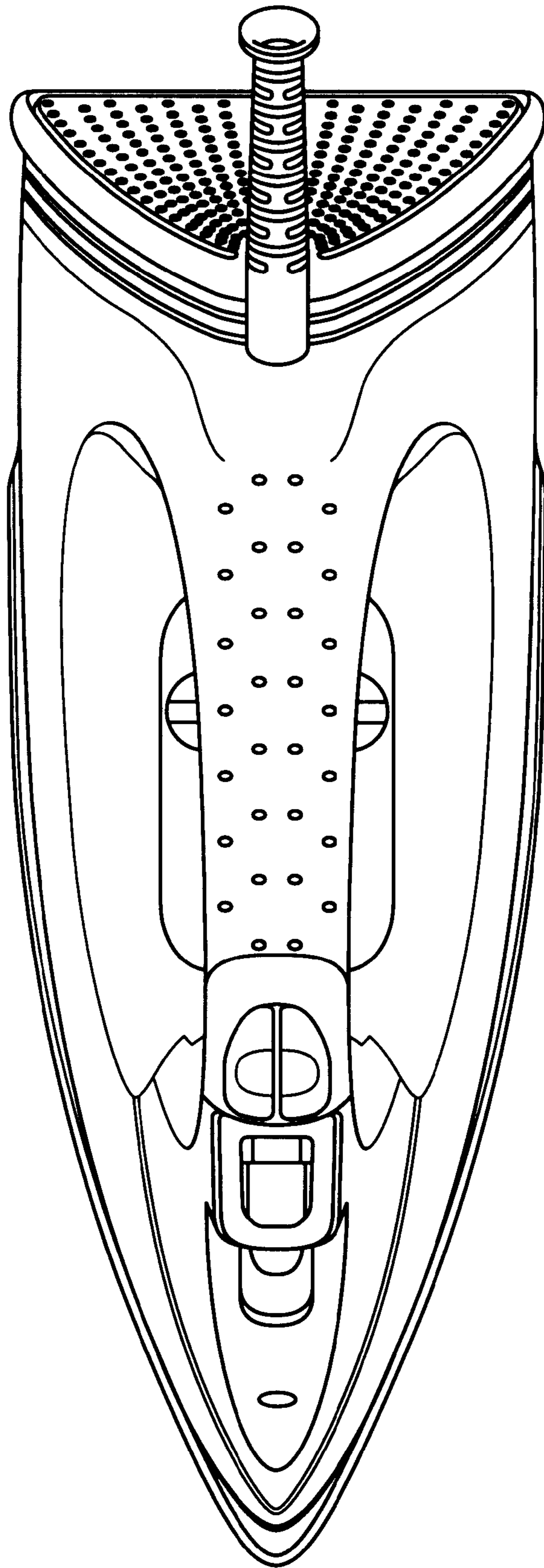

FIG. 3

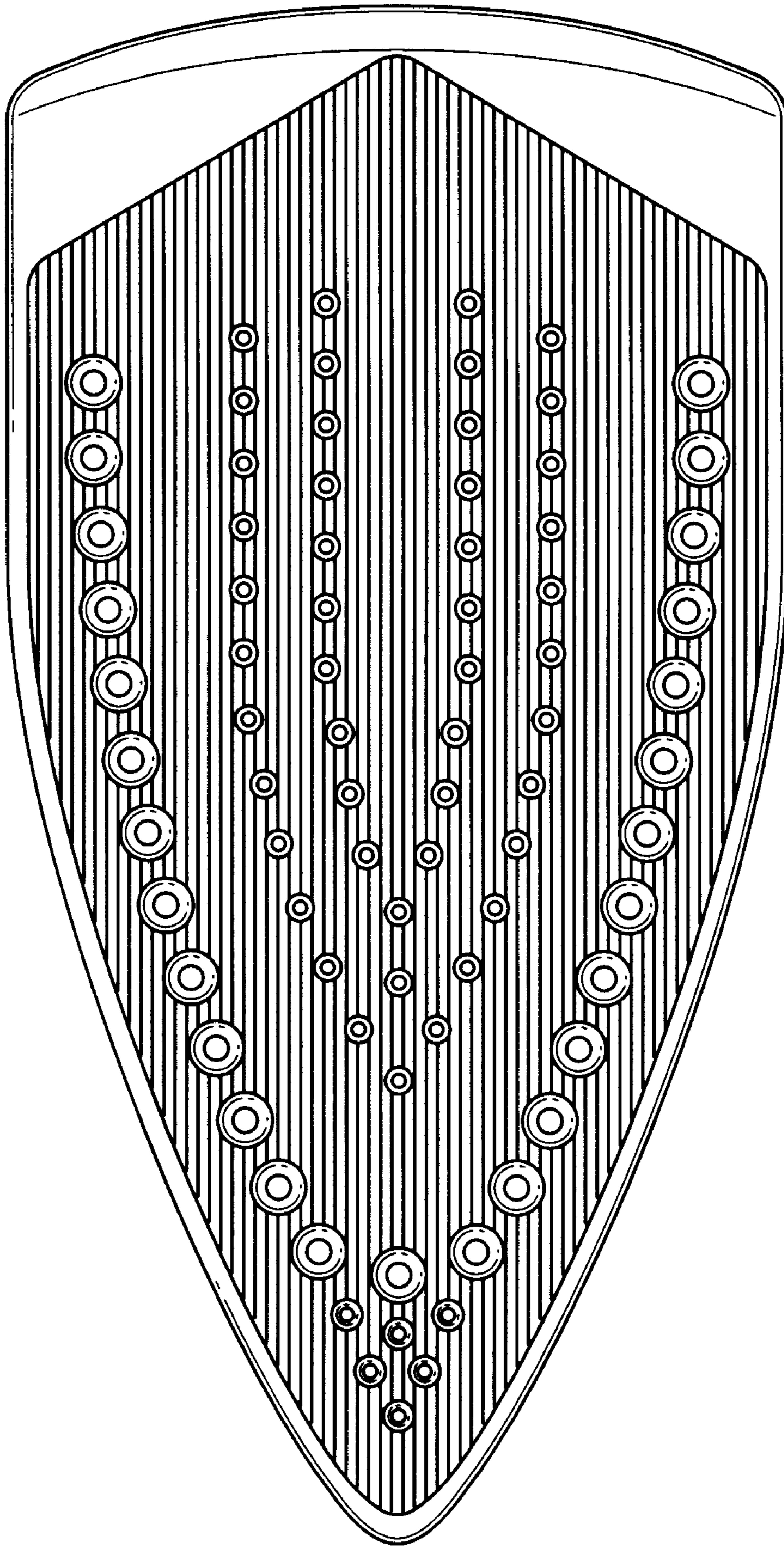

FIG. 4

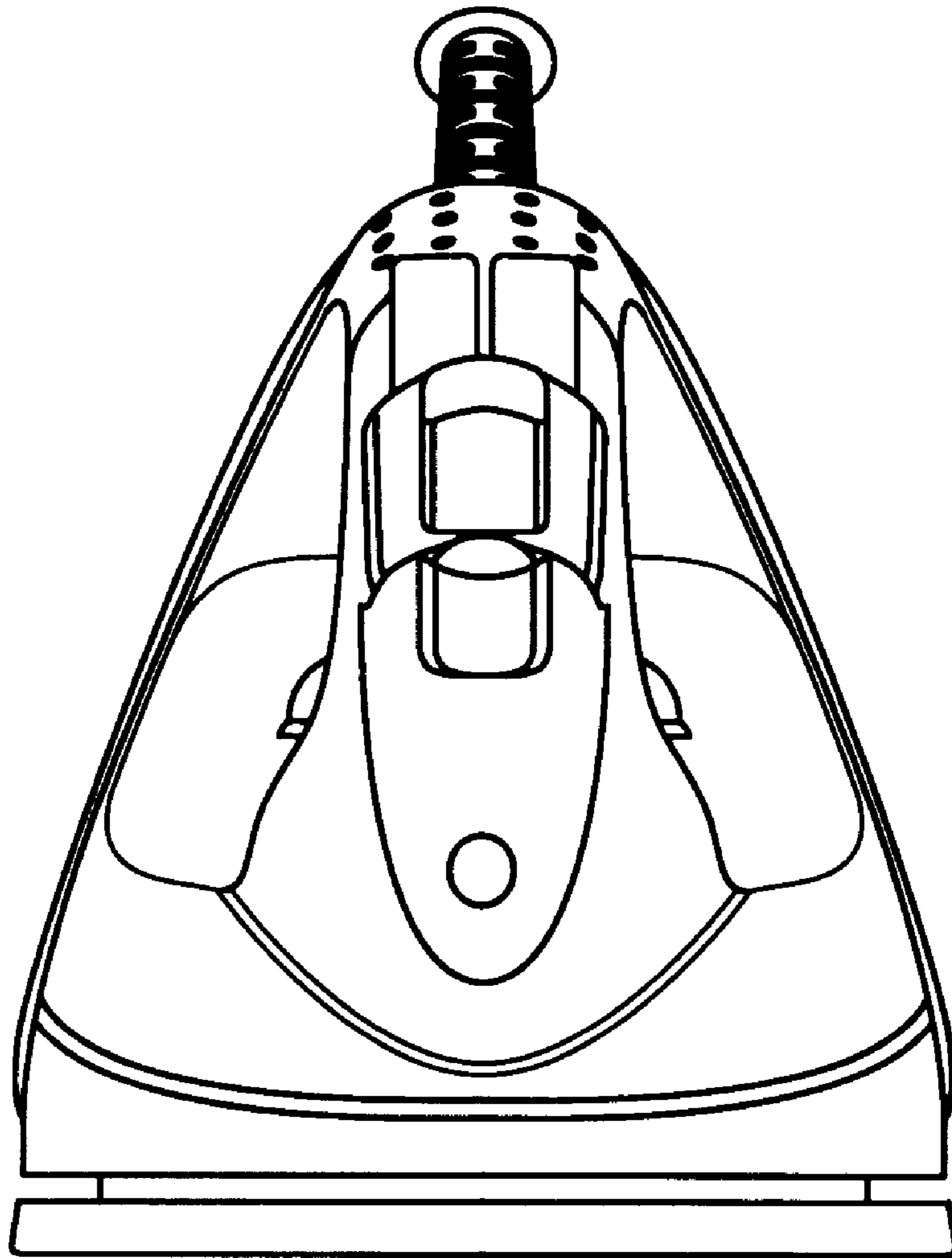

FIG. 5

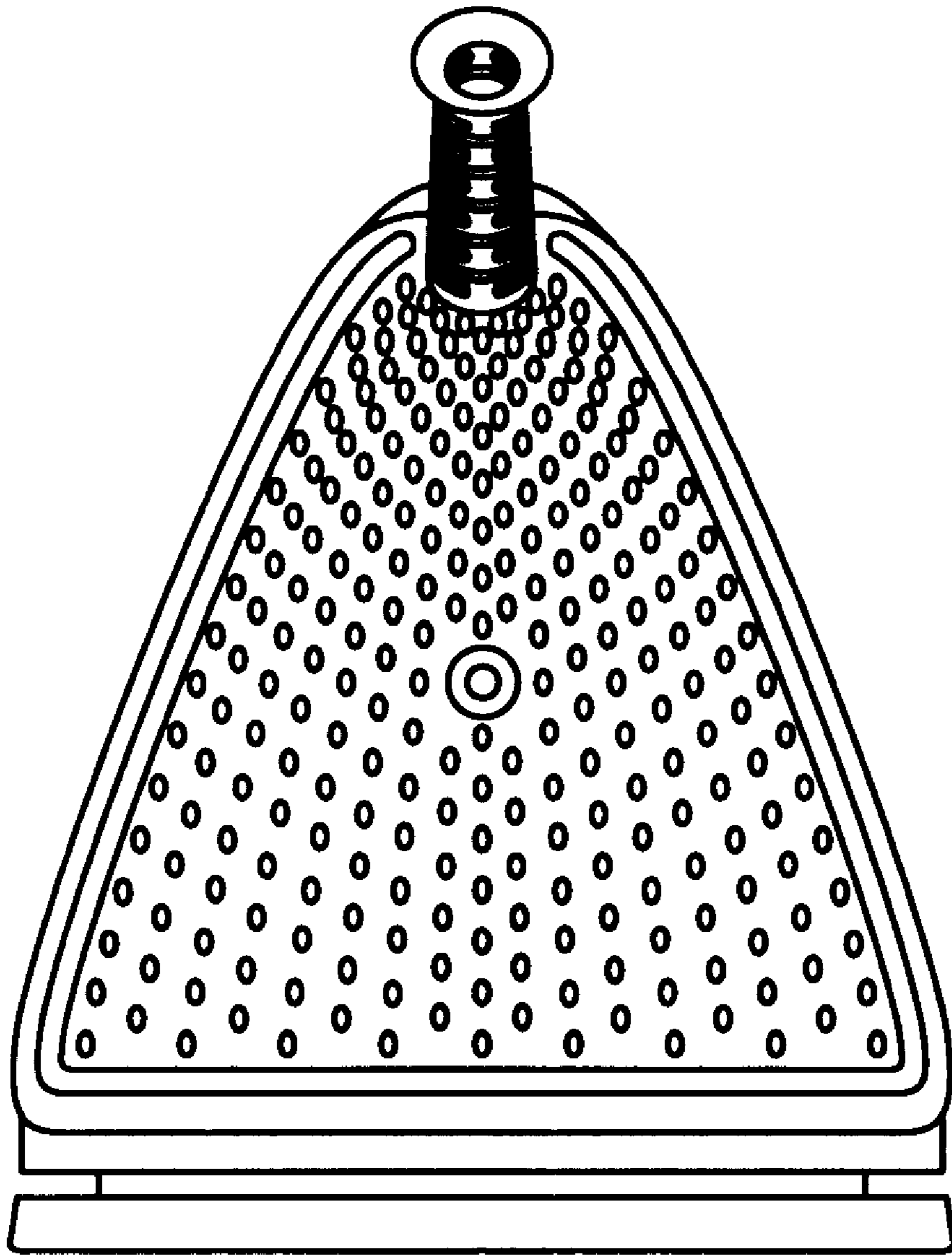

FIG. 6

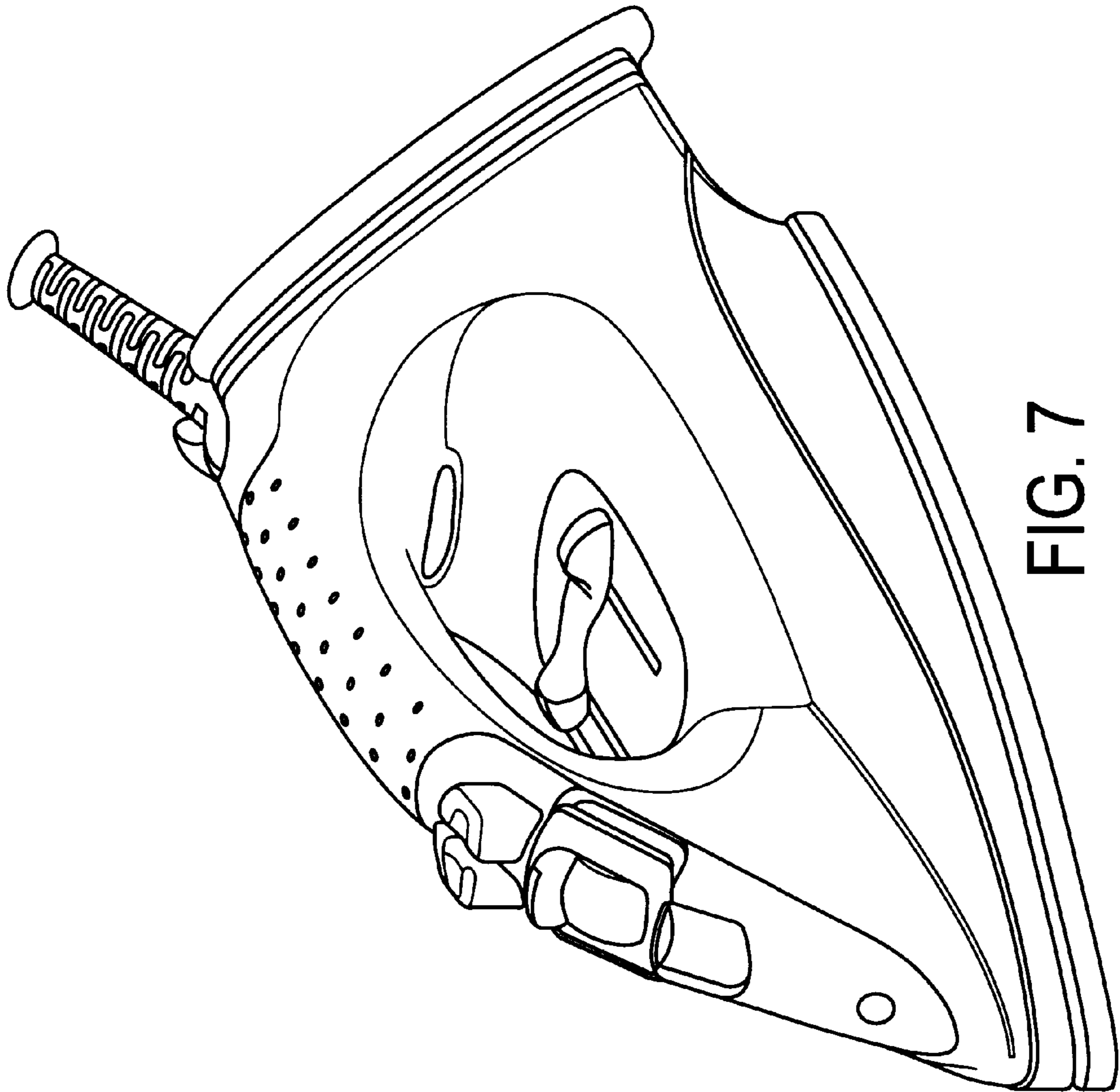

FIG. 7