



US00D427298S

United States Patent [19]

Maust et al.

[11] Patent Number: **Des. 427,298**

[45] Date of Patent: **** Jun. 27, 2000**

[54] **FREE-STANDING FIREPLACE HEARTH**

[75] Inventors: **Daniel A. Maust**, Winfield; **John R. Howard**, Northwoods; **Robert W. Machacek**, Lombard, all of Ill.; **John Desautels**, Bothell, Wash.

[73] Assignee: **Fire Designs, L.L.C.**, Shelbyville, Ky.

[**] Term: **14 Years**

[21] Appl. No.: **29/102,453**

[22] Filed: **Mar. 25, 1999**

[51] **LOC (7) Cl.** **23-03**

[52] **U.S. Cl.** **D23/343**

[58] **Field of Search** D23/403, 343,
D23/346, 342; 26/4, 6, 58, 60-66, 120,
121, 123, 128, 92 AC, 92 R

[56] **References Cited**

U.S. PATENT DOCUMENTS

D. 288,356	2/1987	McKinney	D23/343
D. 359,115	6/1995	Schroeter	D23/343
D. 377,828	2/1997	Wilson	D23/343
D. 384,405	9/1997	Wilson	D23/343

D. 402,019	12/1998	Byrne	D23/346
D. 410,999	6/1999	HenningE	D23/342
1,708,237	4/1929	Pioch	D23/343 X
4,573,905	3/1986	Meyers	.	
4,838,781	6/1989	Fischer	.	
5,026,271	6/1991	Orlov et al.	.	

Primary Examiner—Mitchell Siegel
Attorney, Agent, or Firm—Wood, Herron & Evans

[57] **CLAIM**

The ornamental design for a free-standing fireplace hearth, as shown and described.

DESCRIPTION

FIG. 1 is a perspective view of a free-standing fireplace hearth embodying our new design. FIG. 2 is a front view thereof. FIG. 3 is a right side view thereof, with the left side view being a mirror image of FIG. 3. FIG. 4 is a back view thereof. FIG. 5 is a top view thereof; and, FIG. 6 is a bottom view thereof. The broken line showing is for illustrative purposes only and forms no part of the claimed design.

1 Claim, 2 Drawing Sheets

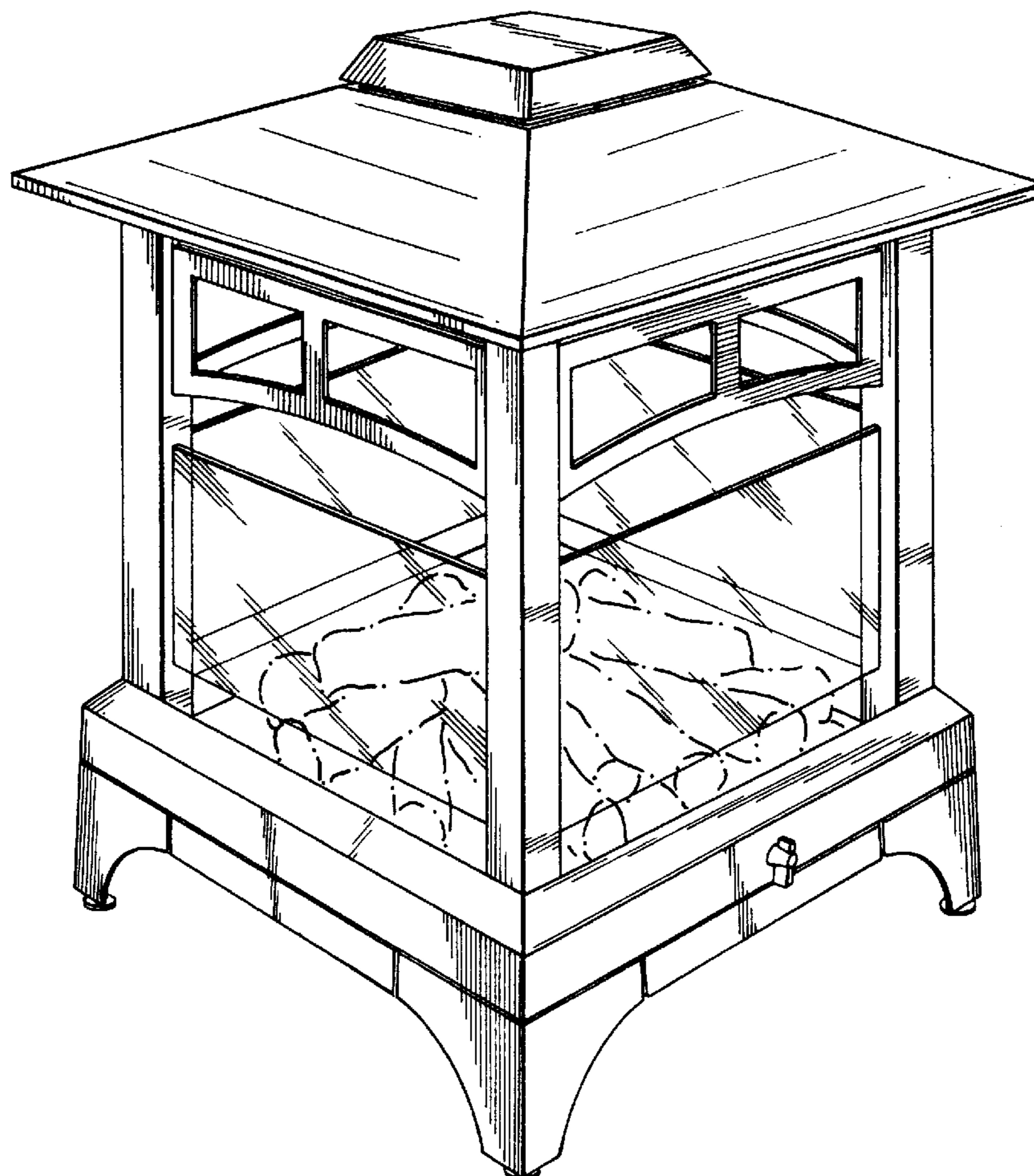

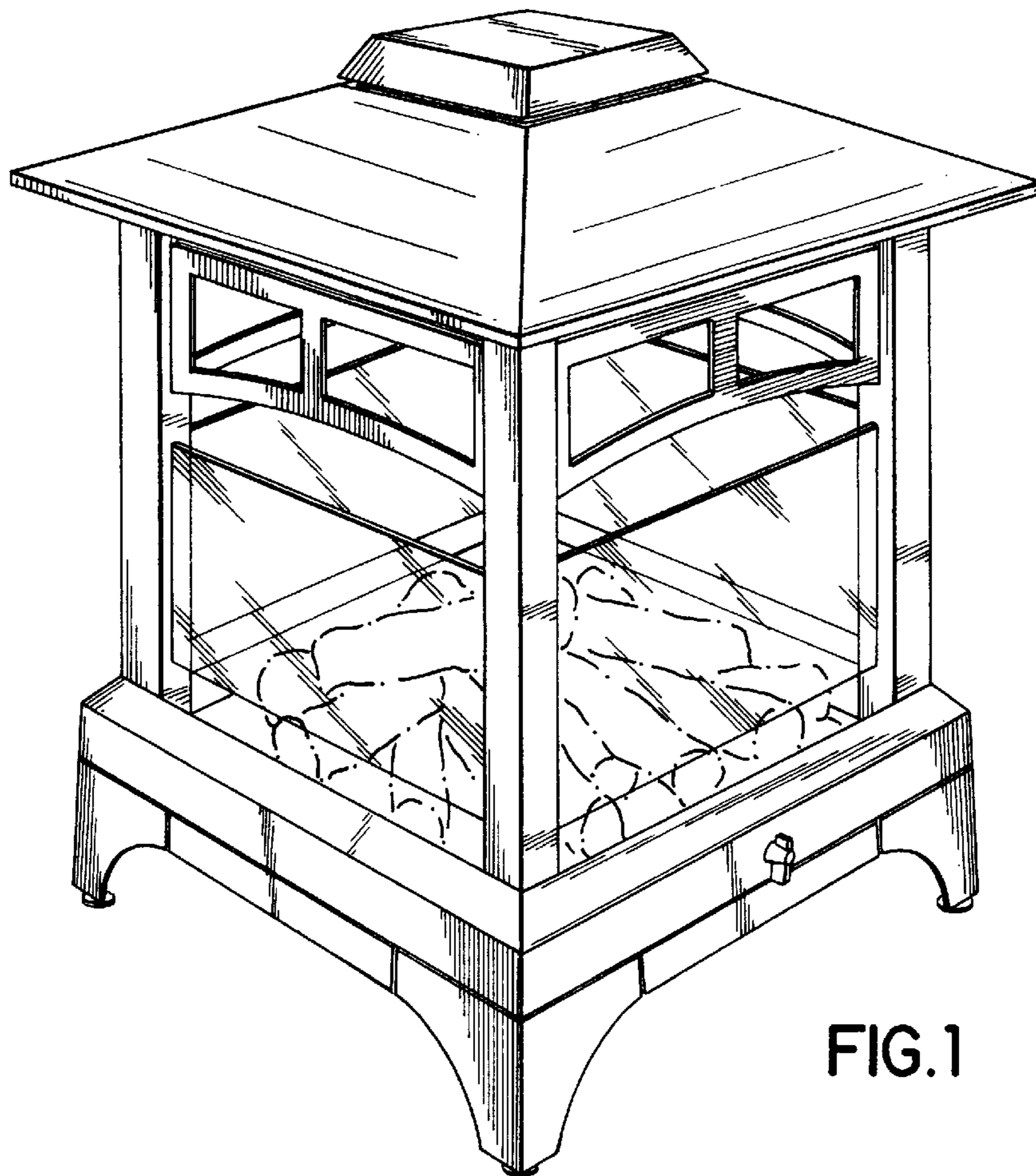

FIG. 1

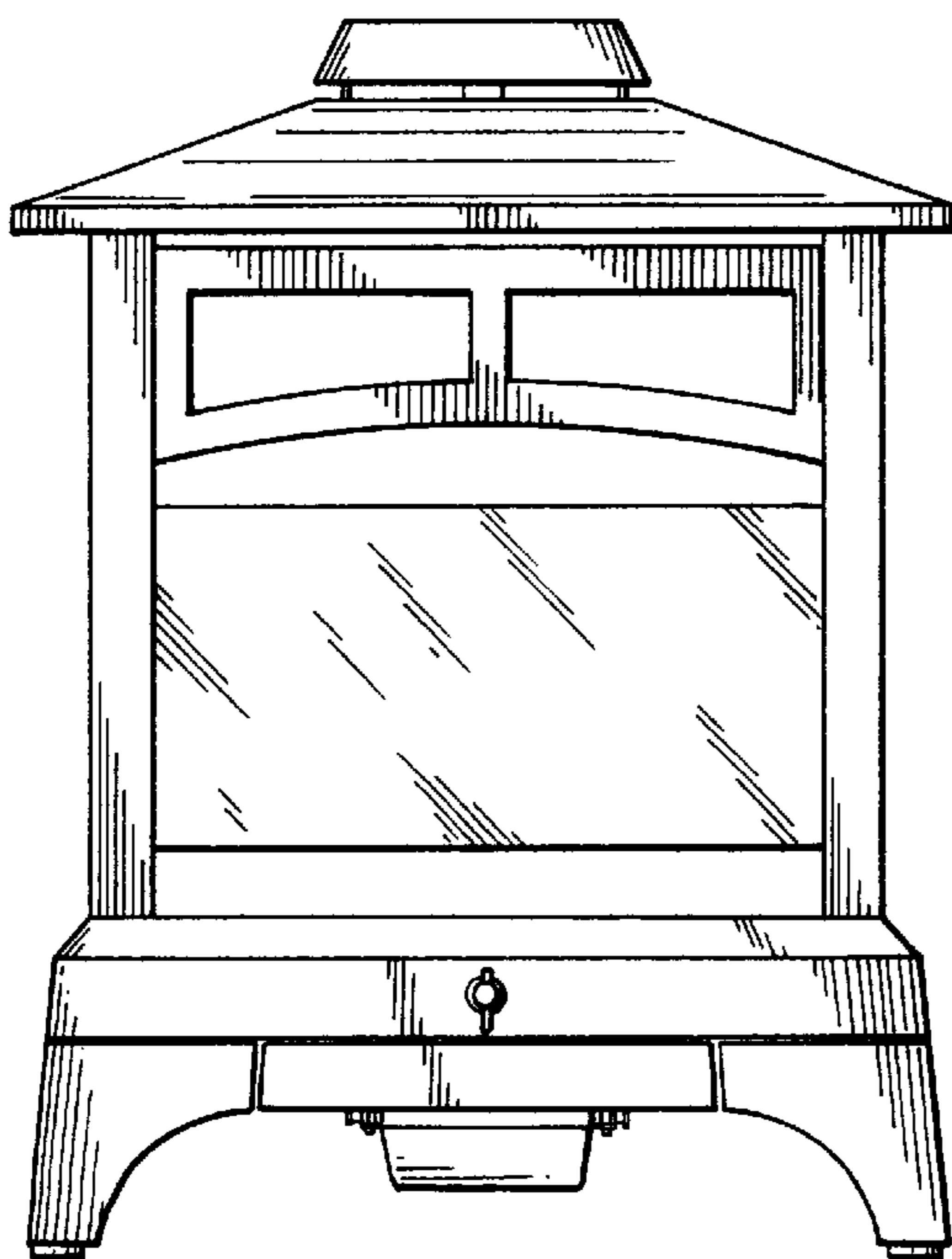

FIG. 2

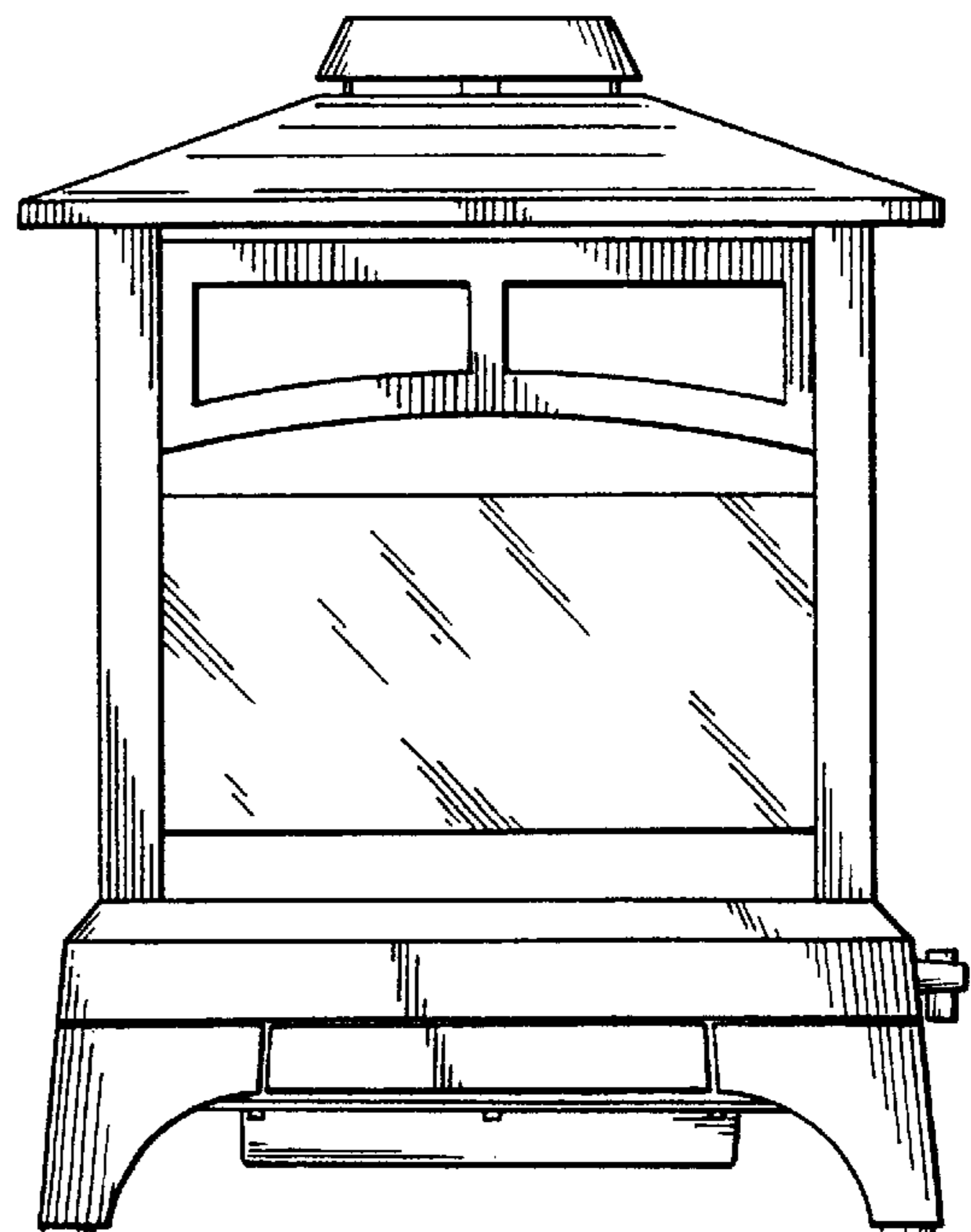

FIG. 3

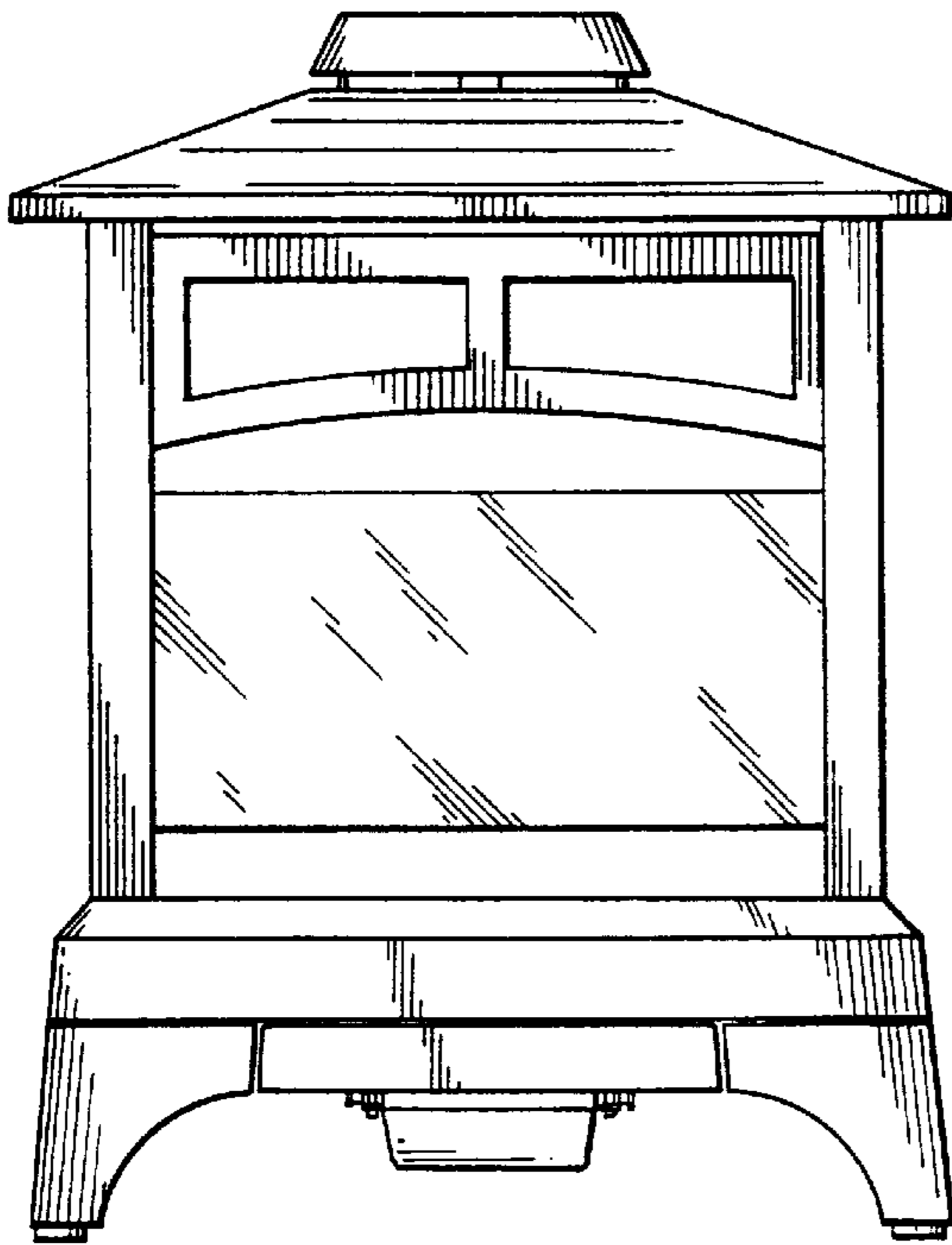

FIG. 4

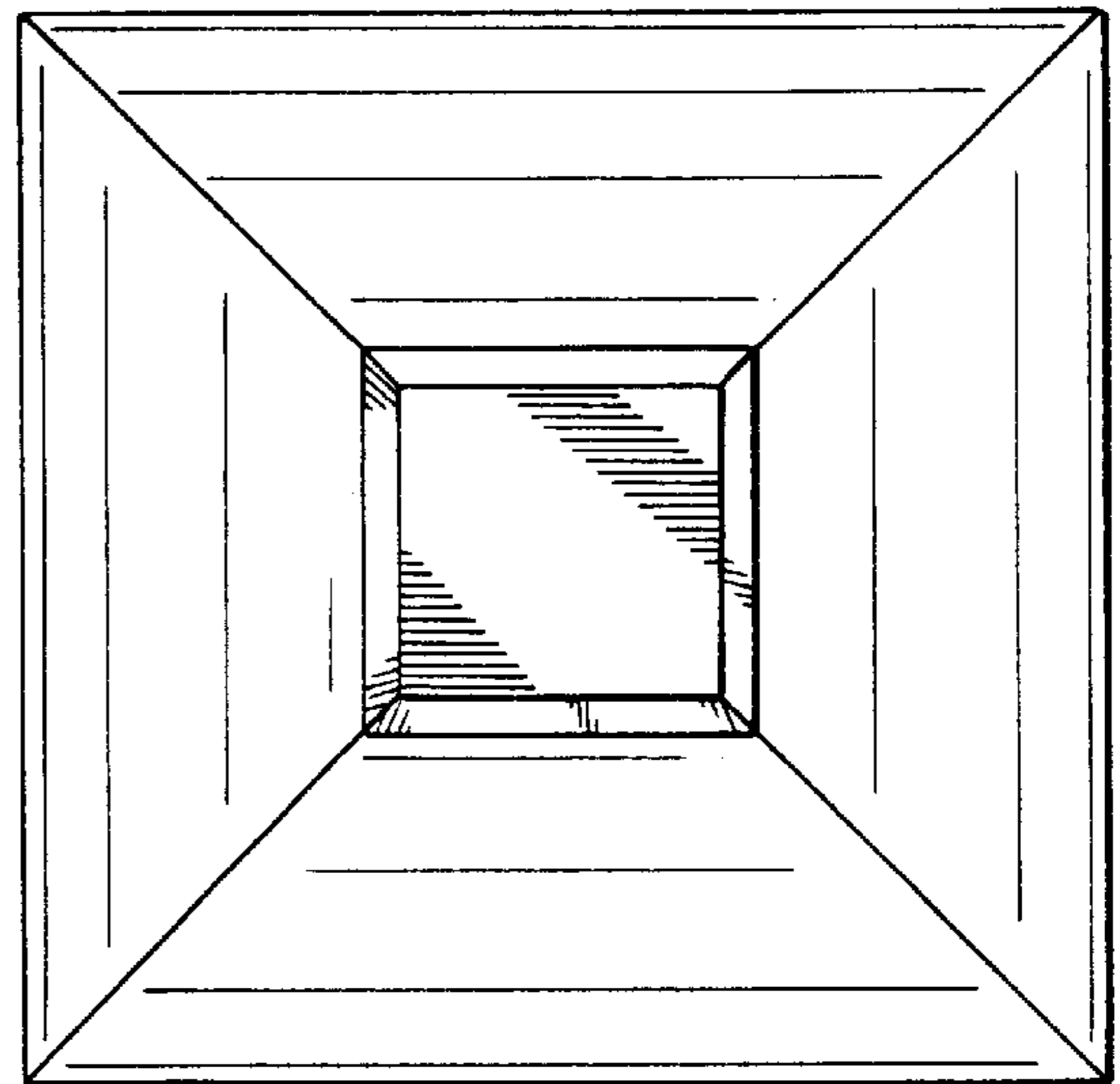

FIG. 5

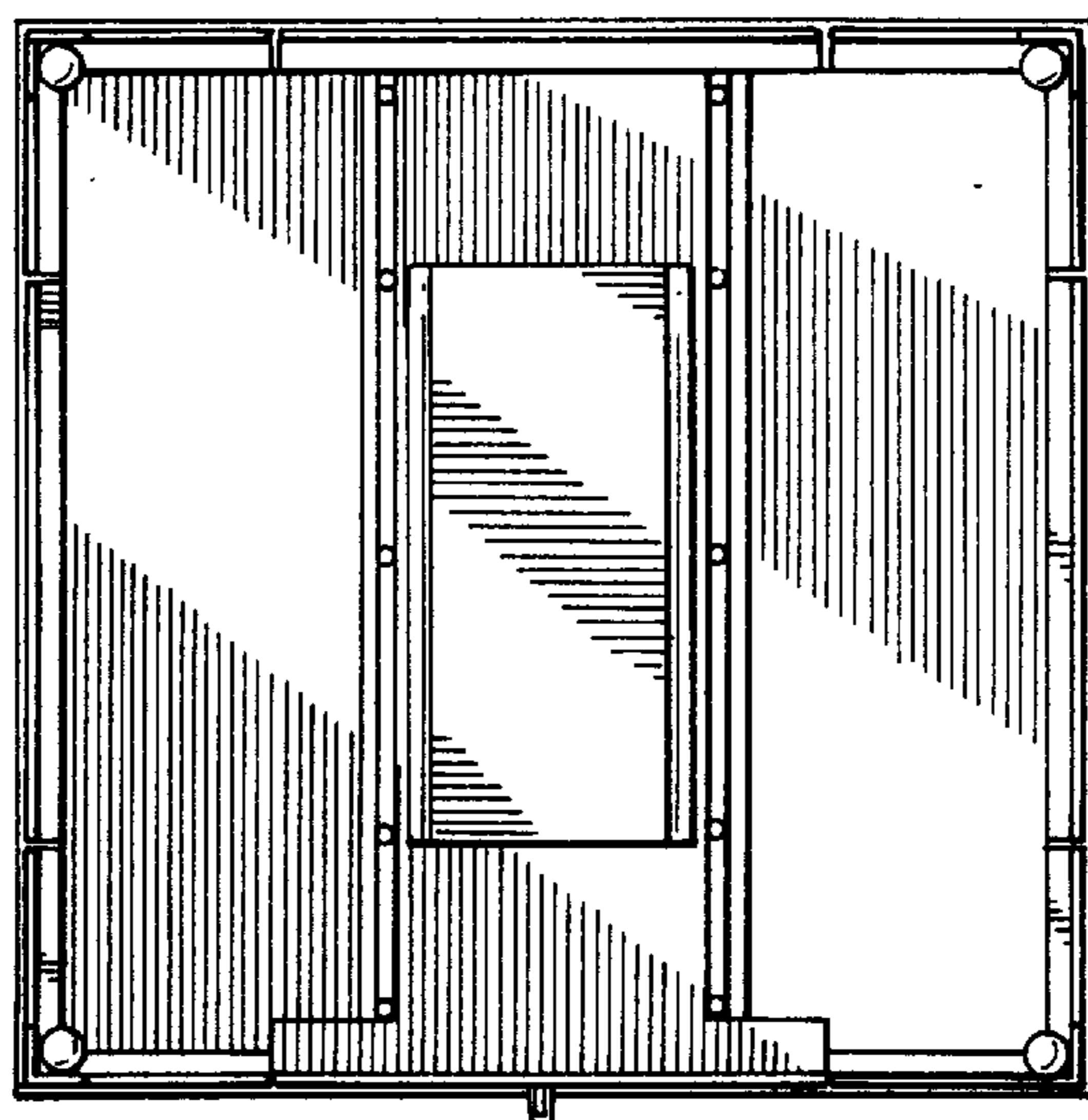

FIG. 6