



US00D427290S

United States Patent [19]

Milrud et al.

[11] Patent Number: Des. 427,290

[45] Date of Patent: ** Jun. 27, 2000

[54] **SHOWER CONTROL**

[75] Inventors: **Eduardo Milrud**, Chagrin Falls; **Daniel C. Buchner**, Lorain; **Eric D. Green**, Cleveland Heights; **Shannon E. Mason**, Avon Lake, all of Ohio; **John C. Costello**, Wellesley, Mass.; **David Malina**; **Stephanie C. Schwarz**, both of Boston, Mass.; **Thorben Neu**, Cambridge, Mass.

[73] Assignee: **Moen Incorporated**, North Olmsted, Ohio

[**] Term: **14 Years**

[21] Appl. No.: **29/111,735**

[22] Filed: **Oct. 4, 1999**

[51] **LOC (7) Cl.** **23-01**

[52] **U.S. Cl.** **D23/254**

[58] **Field of Search** D23/238-243,
D23/250-257; D8/352, 300-308; 4/675-678;
16/112-121

[56] **References Cited**

U.S. PATENT DOCUMENTS

- D. 169,434 4/1953 Gredell D23/252
- D. 190,897 7/1961 Chapman D23/252
- D. 199,426 10/1964 Armstrong D23/252

- D. 209,804 1/1968 Landell D23/252
- D. 258,835 4/1981 Saporito et al. D23/242
- D. 263,990 4/1982 Fleischmann et al. .
- D. 319,294 8/1991 Kohler, Jr. et al. D23/254
- D. 355,021 1/1995 Schott et al. D23/254
- D. 363,765 10/1995 Starck D23/254
- D. 368,957 4/1996 Bavoso D23/252
- D. 397,771 9/1998 Lobermeier D23/254
- D. 400,651 11/1998 Hundley et al. .

Primary Examiner—Eric Watterson
Attorney, Agent, or Firm—McEachran, Jambor, Keating, Bock & Kurtz

[57] **CLAIM**

The ornamental design for a shower control, as shown and described.

DESCRIPTION

FIG. 1 is a front perspective view of our new design for a shower control;
FIG. 2 is a right side view thereof, the left side being the same as the right side;
FIG. 3 is a front view thereof;
FIG. 4 is a top view thereof;
FIG. 5 is a bottom view thereof; and,
FIG. 6 is rear view thereof.

The broken line showing is for illustrative purposes only and forms no part of the claimed designed.

1 Claim, 2 Drawing Sheets

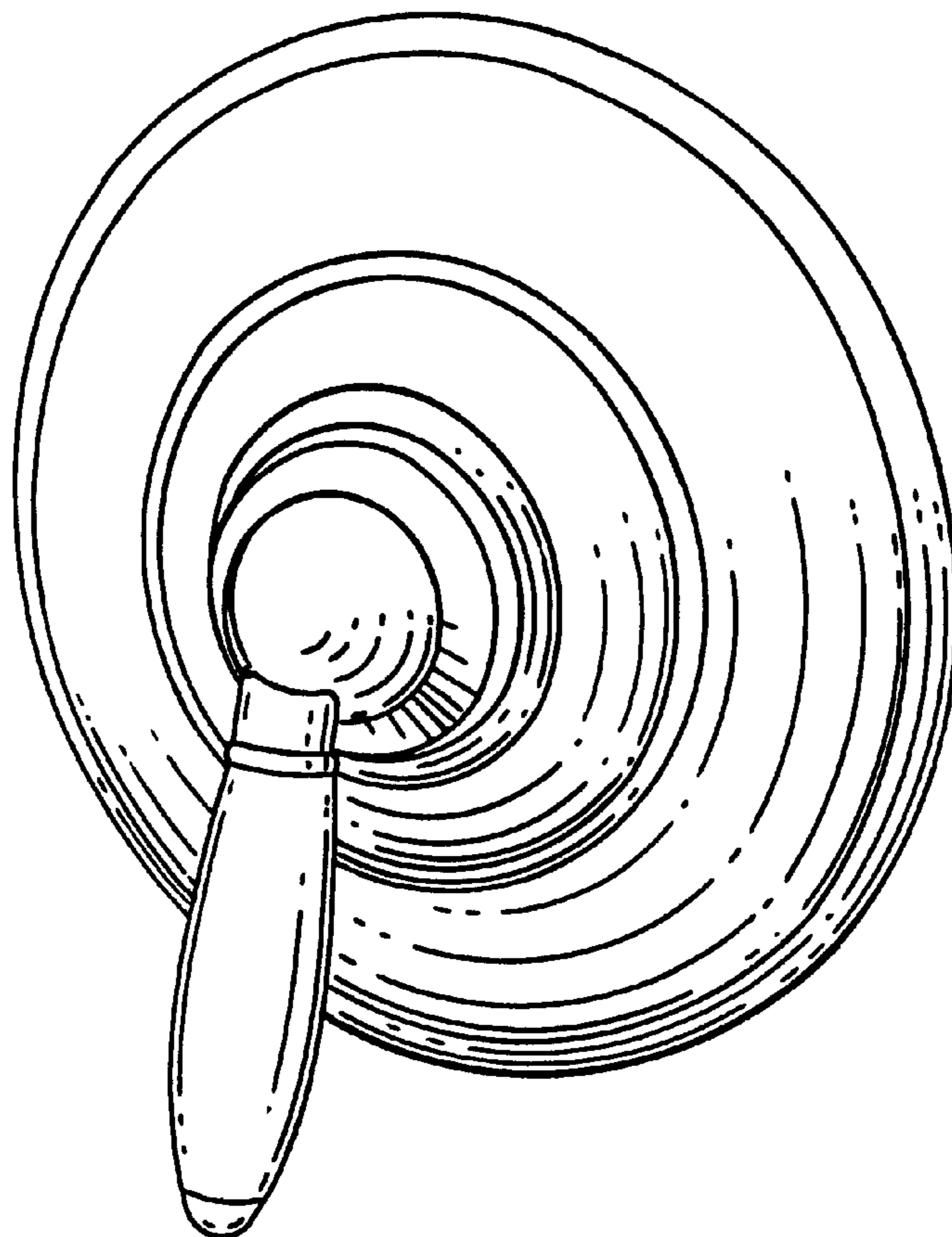

Fig. 1.

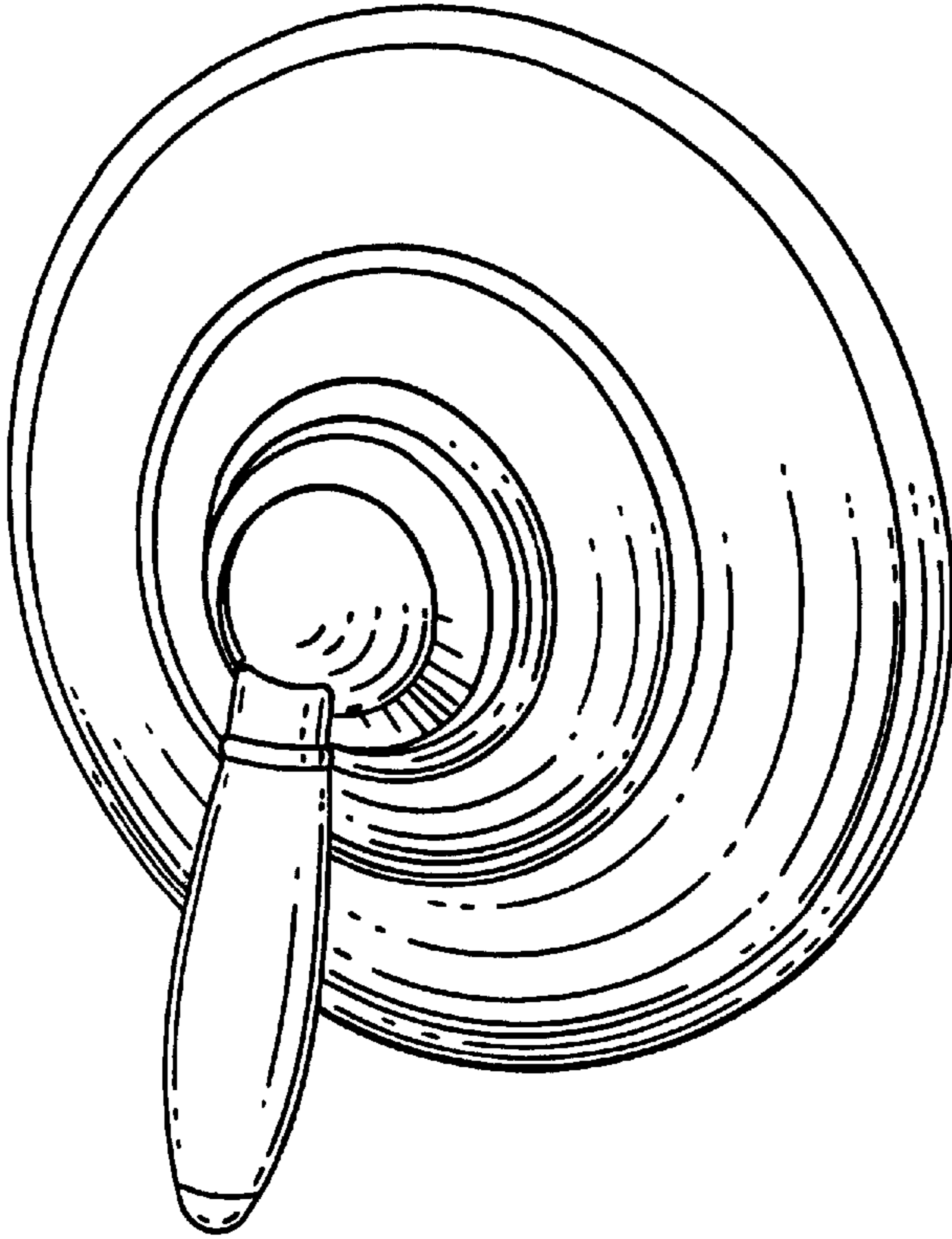

Fig. 2.

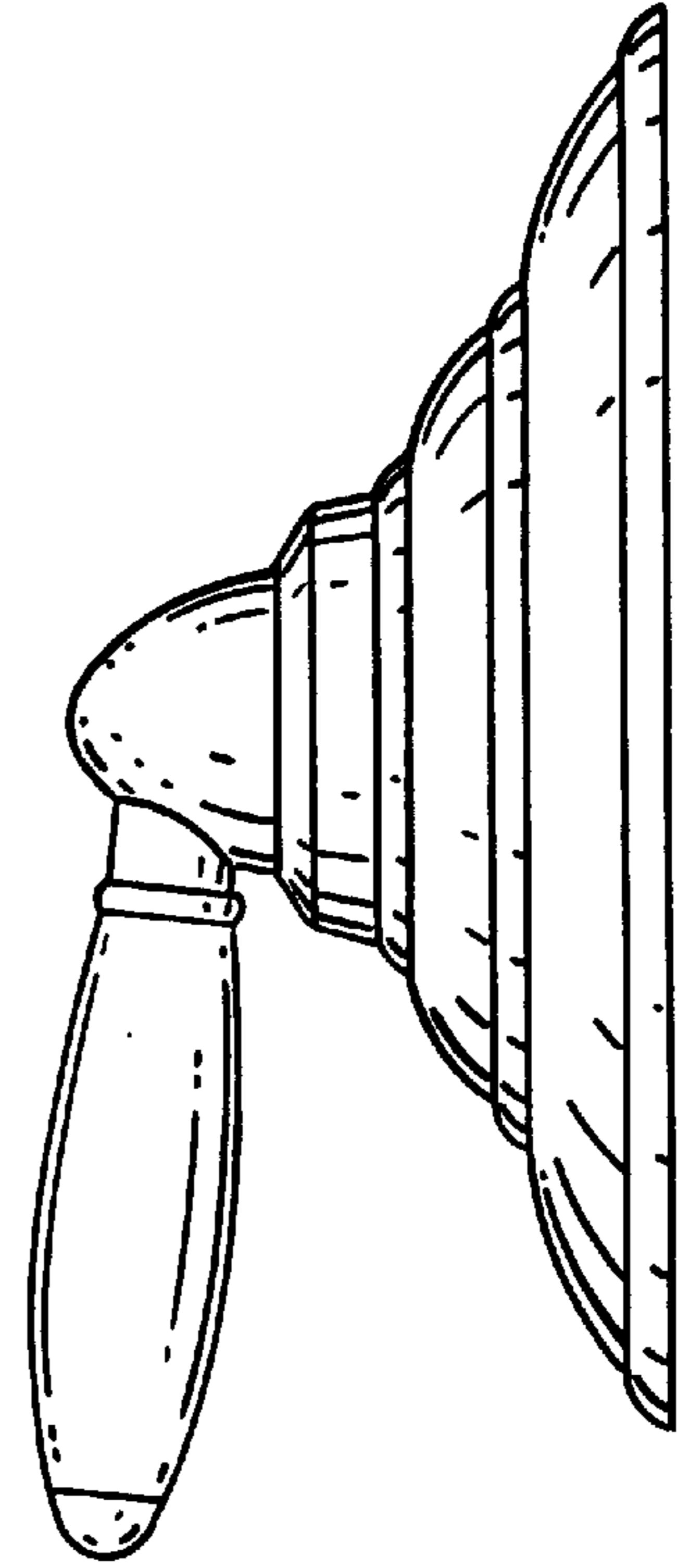

Fig. 3.

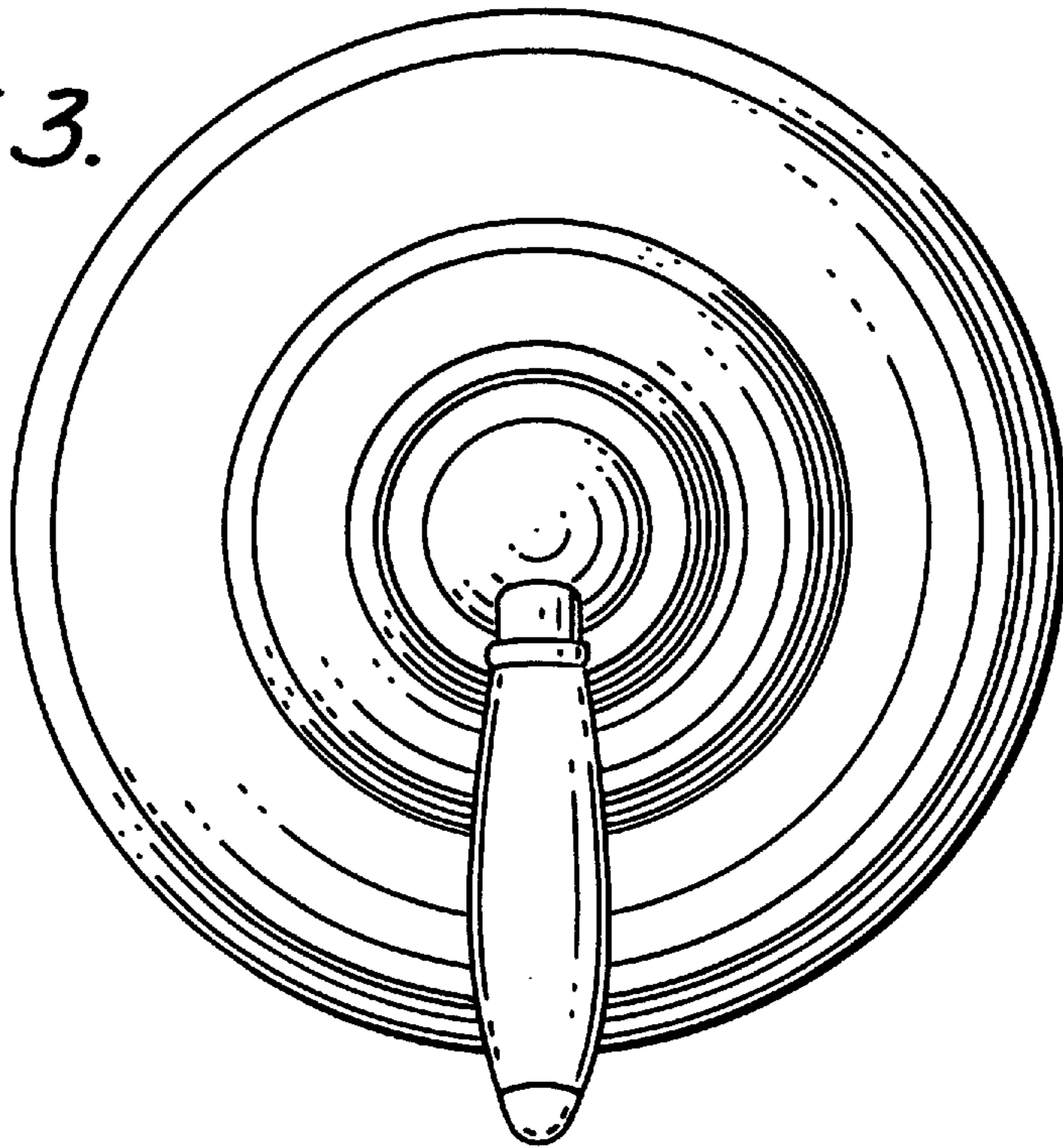

FIG. 4.

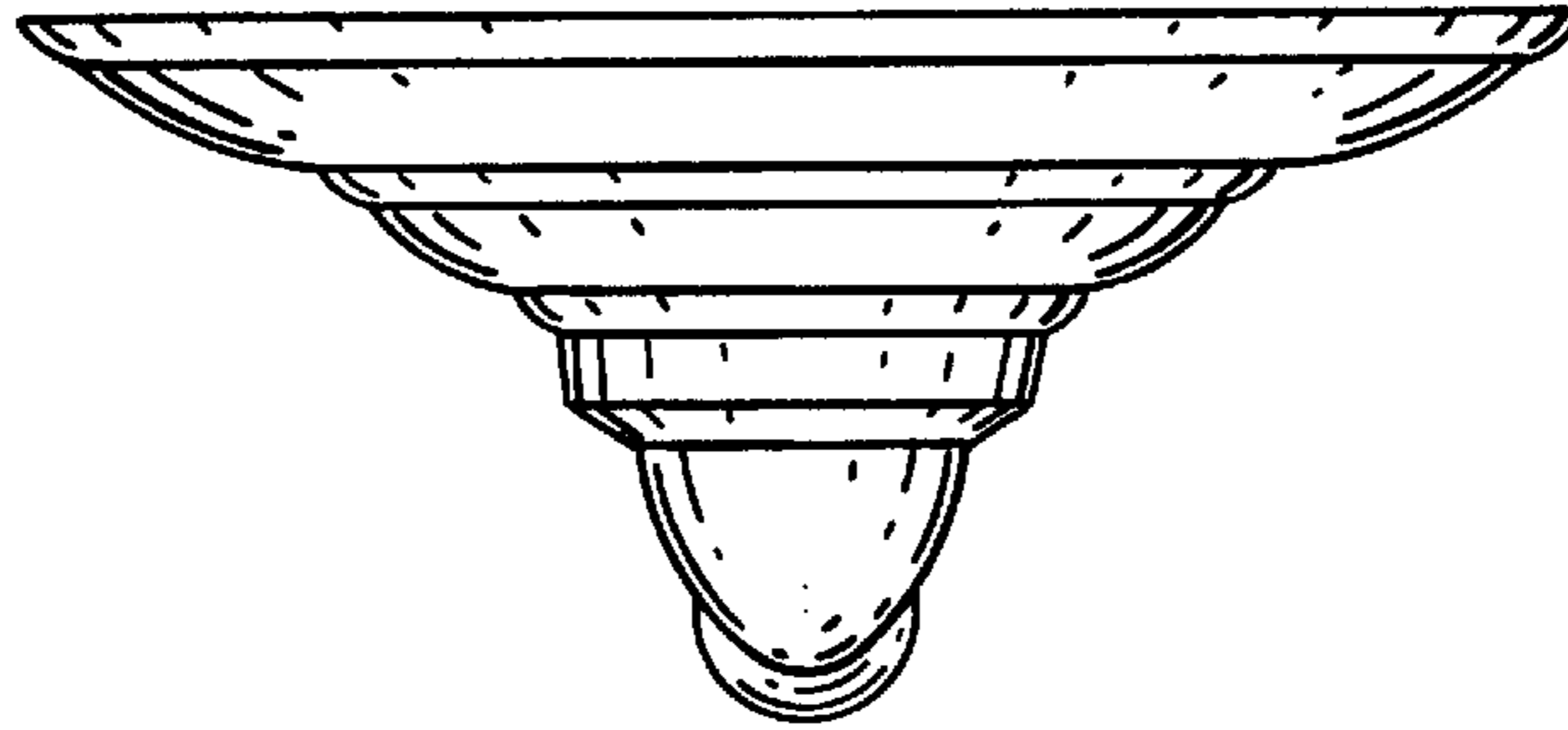

FIG. 5.

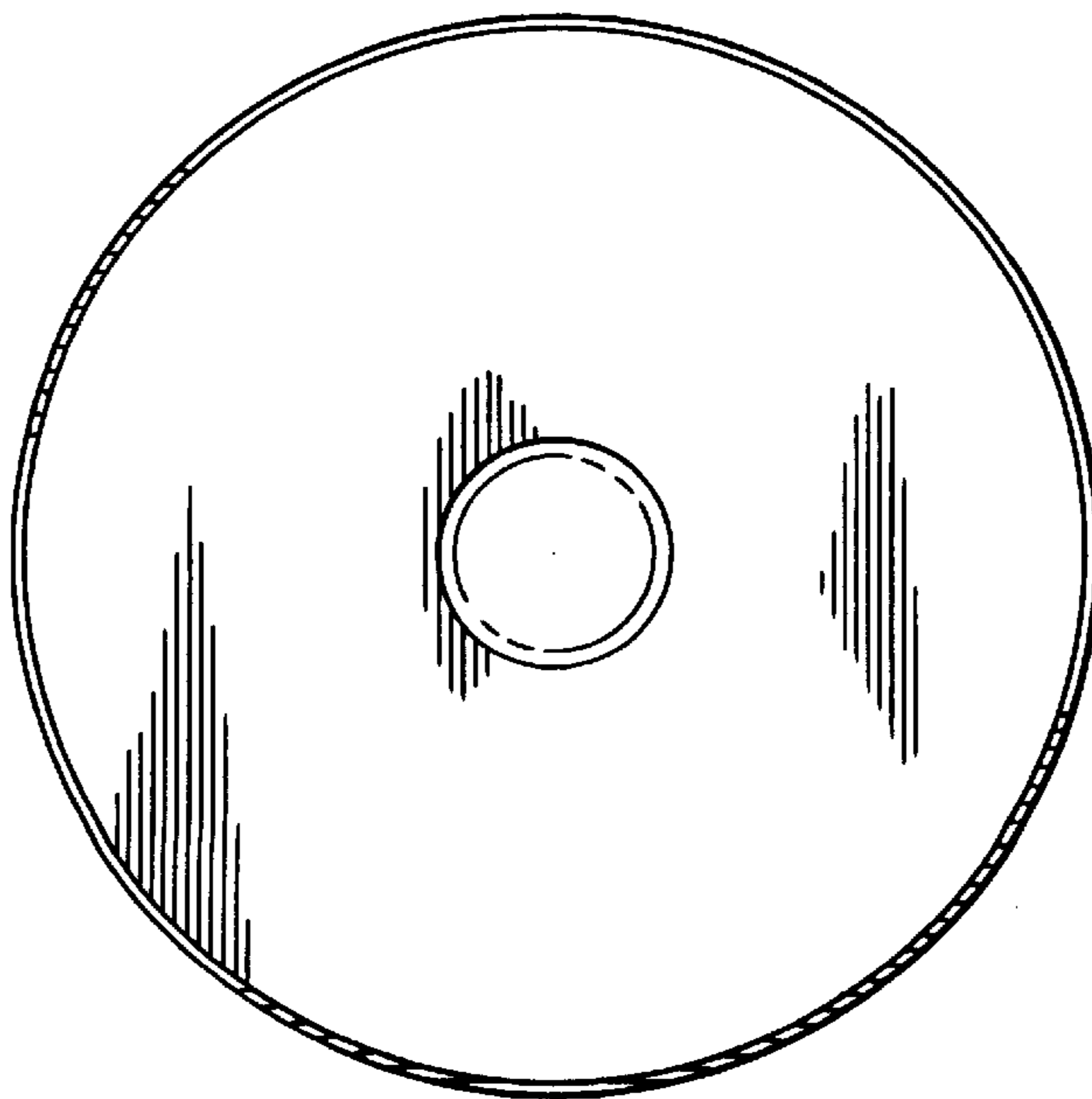
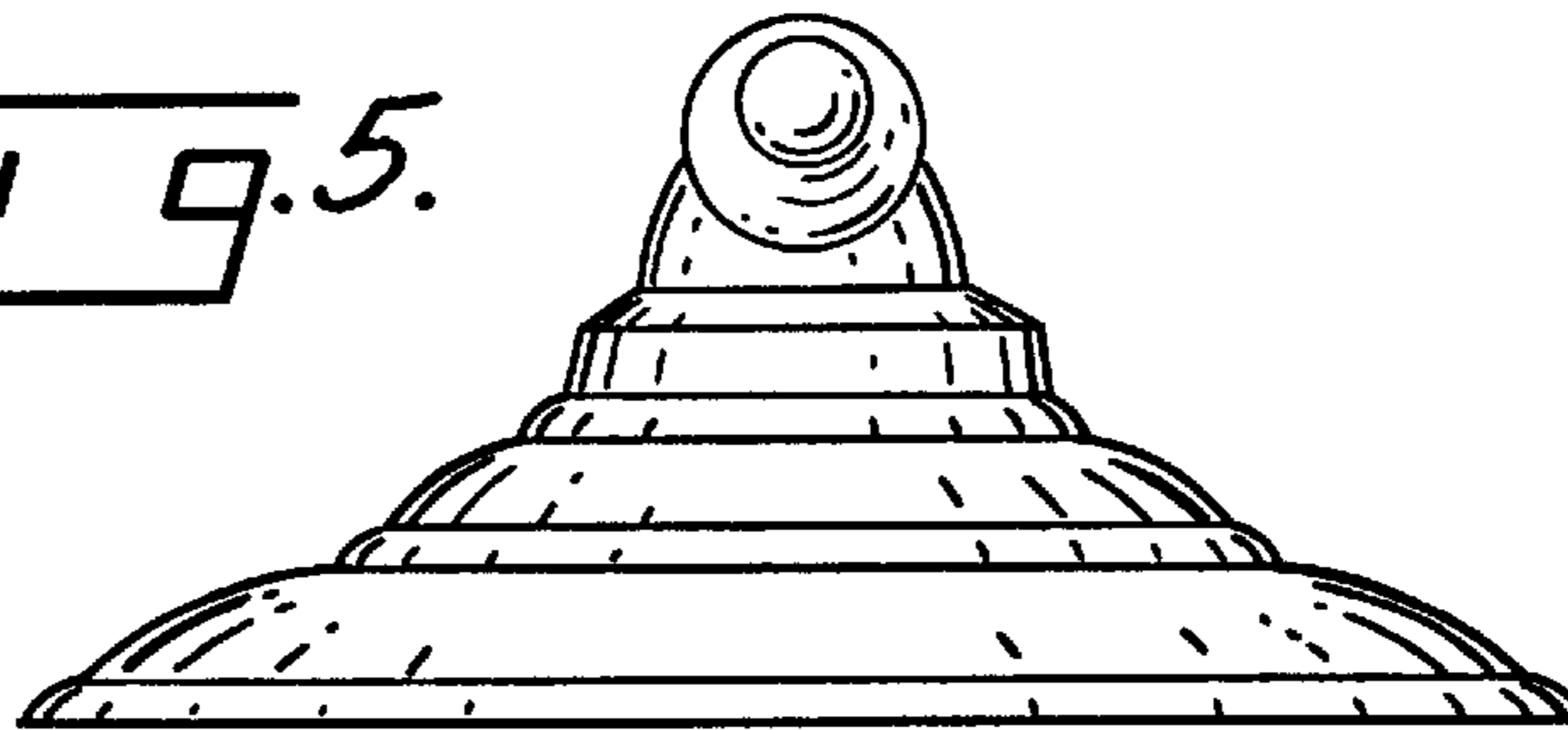

FIG. 6.