



US00D427281S

# United States Patent [19] Guo

[11] **Patent Number: Des. 427,281**

[45] **Date of Patent: \*\* Jun. 27, 2000**

[54] **SPRAYER DEVICE**

OTHER PUBLICATIONS

[76] Inventor: **Wen-Li Guo**, No. 10, Fang Dong Road, Wen Gin Tsuen, Fang Yuan Hsiang, Chang Hua Hsien, Taiwan

Nelson Rainshower catalog; #1015 Rainshower 40 sprinker; p. 15; design digest, 1995.

[\*\*] Term: **14 Years**

*Primary Examiner*—Robin V. Taylor  
*Attorney, Agent, or Firm*—Charles E Baxley, Esq.

[21] Appl. No.: **29/108,228**

[57] **CLAIM**

[22] Filed: **Jul. 26, 1999**

The ornamental design for a sprayer device, as shown and described.

[51] **LOC (7) Cl.** ..... **23-01**

**DESCRIPTION**

[52] **U.S. Cl.** ..... **D23/216**

[58] **Field of Search** ..... D23/213, 214, D23/215, 216; 239/230-1, 240-242, 211

FIG. 1 is a perspective view of a sprayer device showing my new design;

FIG. 2 is a front elevational view thereof;

FIG. 3 is a rear elevational view thereof;

FIG. 4 is a top plan view thereof;

FIG. 5 is a bottom plan view thereof;

FIG. 6 is a left side elevational view thereof; and,

FIG. 7 is a right side elevational view thereof.

[56] **References Cited**

U.S. PATENT DOCUMENTS

D. 281,996	12/1985	Hayes	.....	D23/216
D. 398,952	9/1998	Hsueh	.....	D23/216
D. 418,576	1/2000	Heren	.....	D23/216
3,286,929	11/1966	Henningesen	.....	239/242
4,568,023	2/1986	Hayes	.....	239/242

**1 Claim, 4 Drawing Sheets**

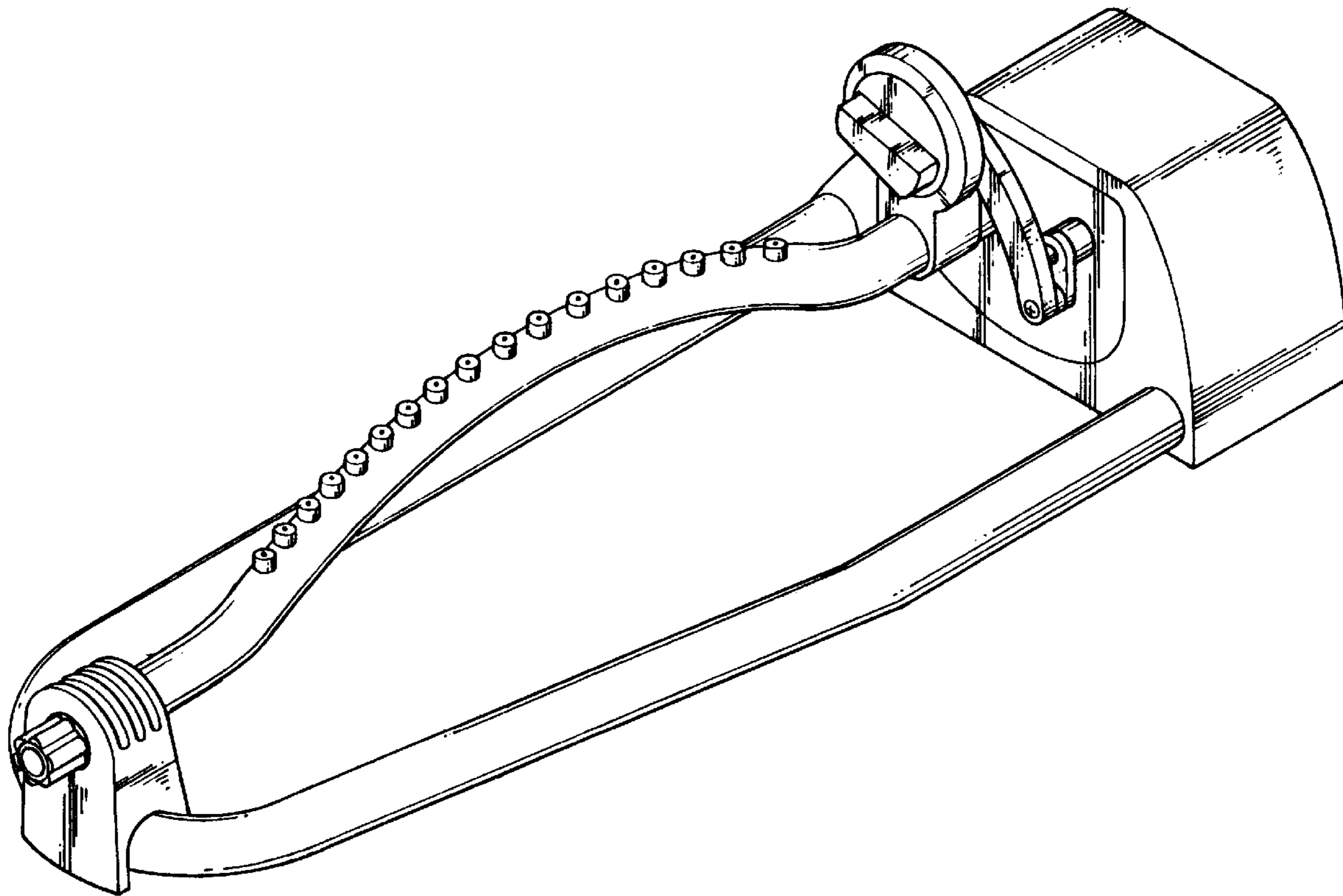

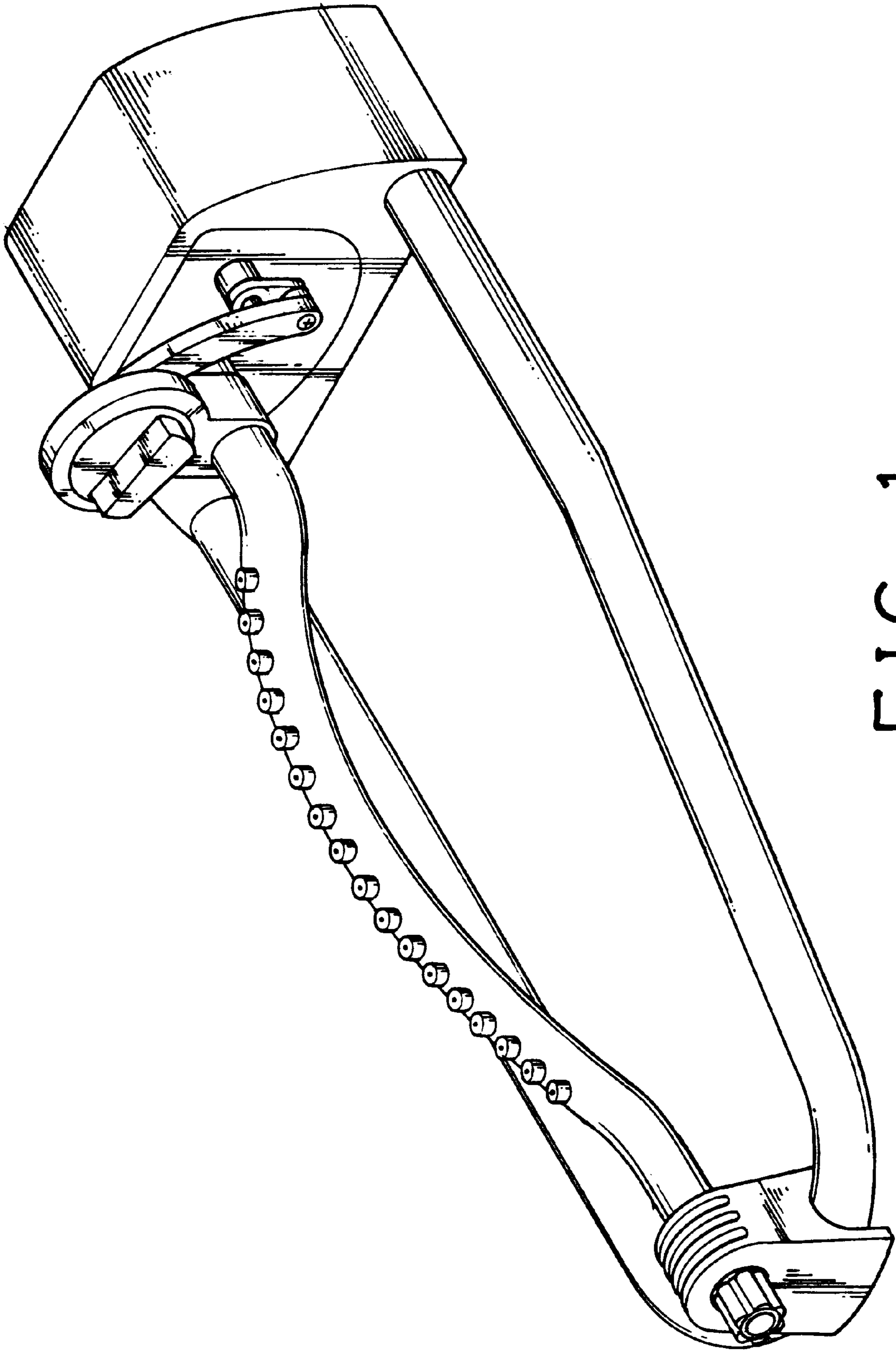

FIG. 1

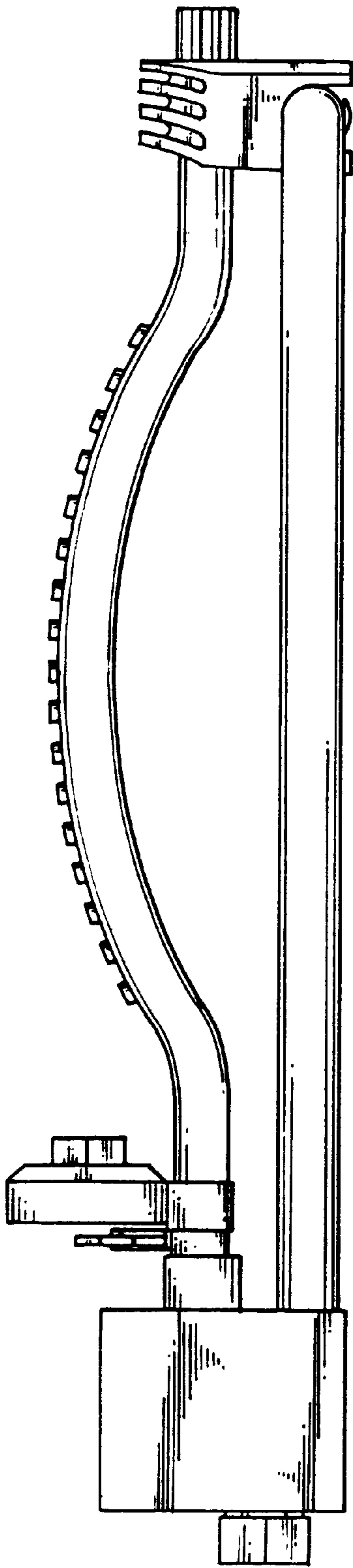

FIG. 3

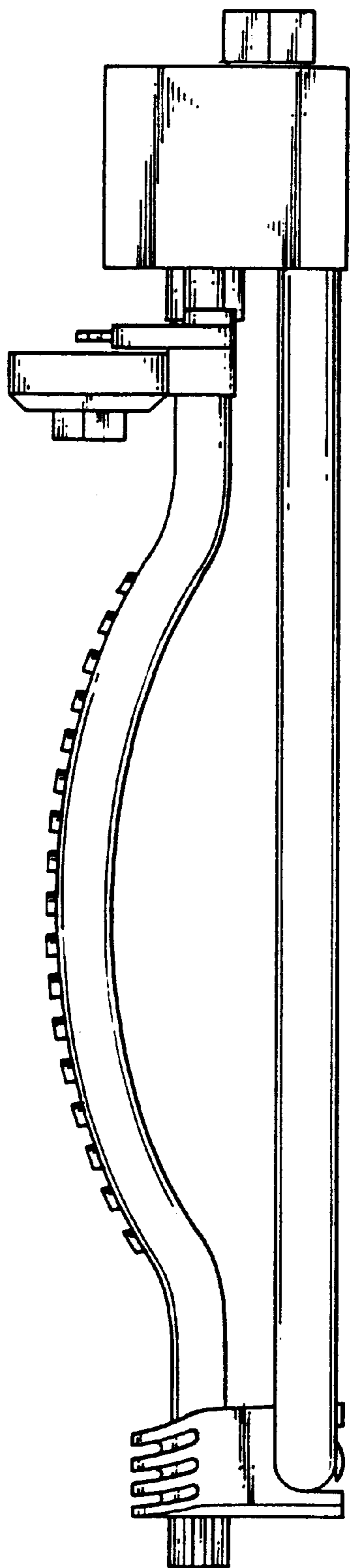

FIG. 2

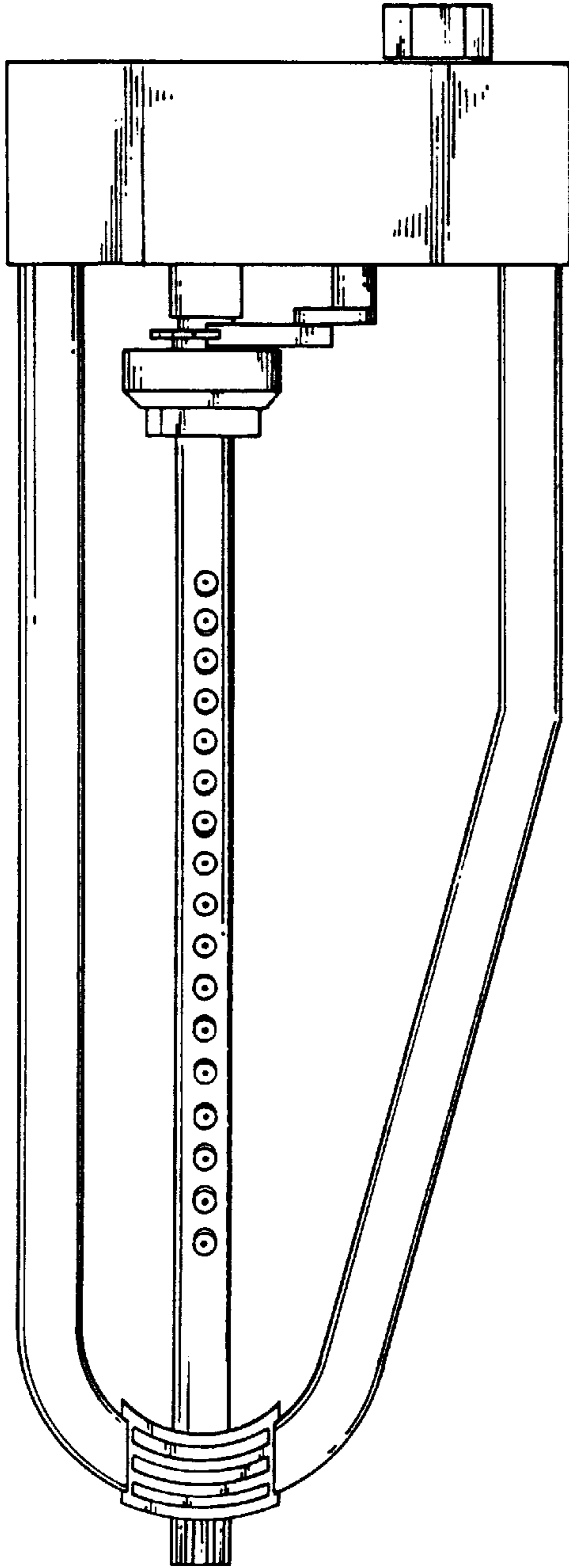

FIG. 4

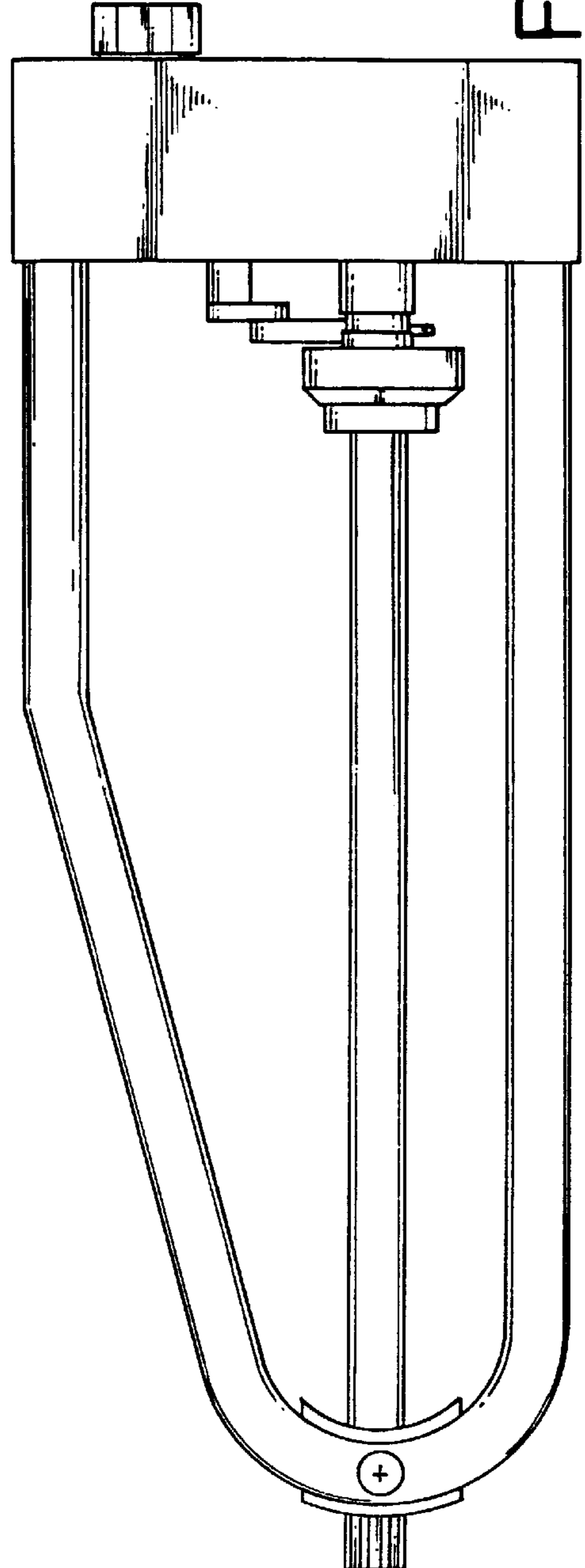

FIG. 5

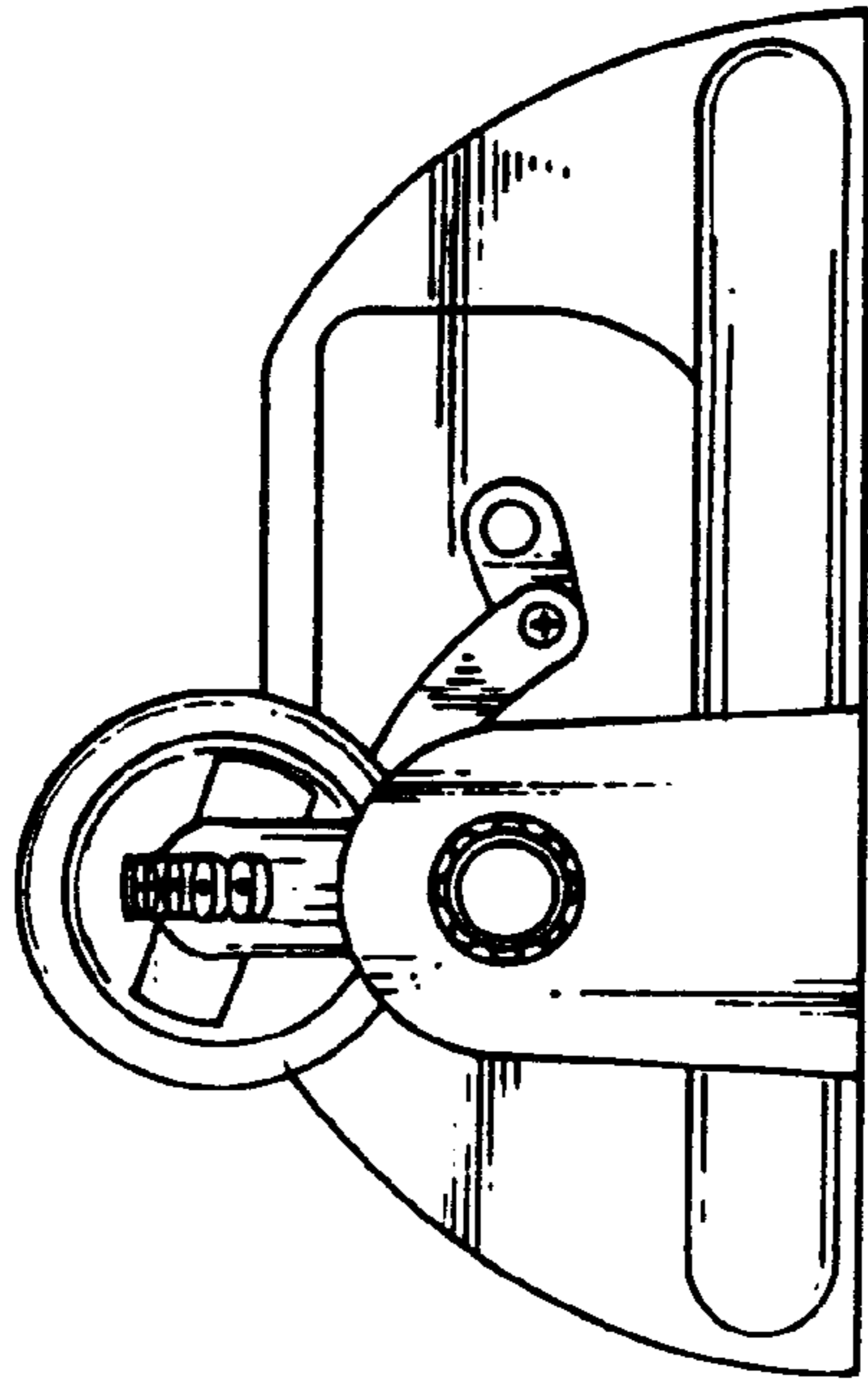

FIG. 6

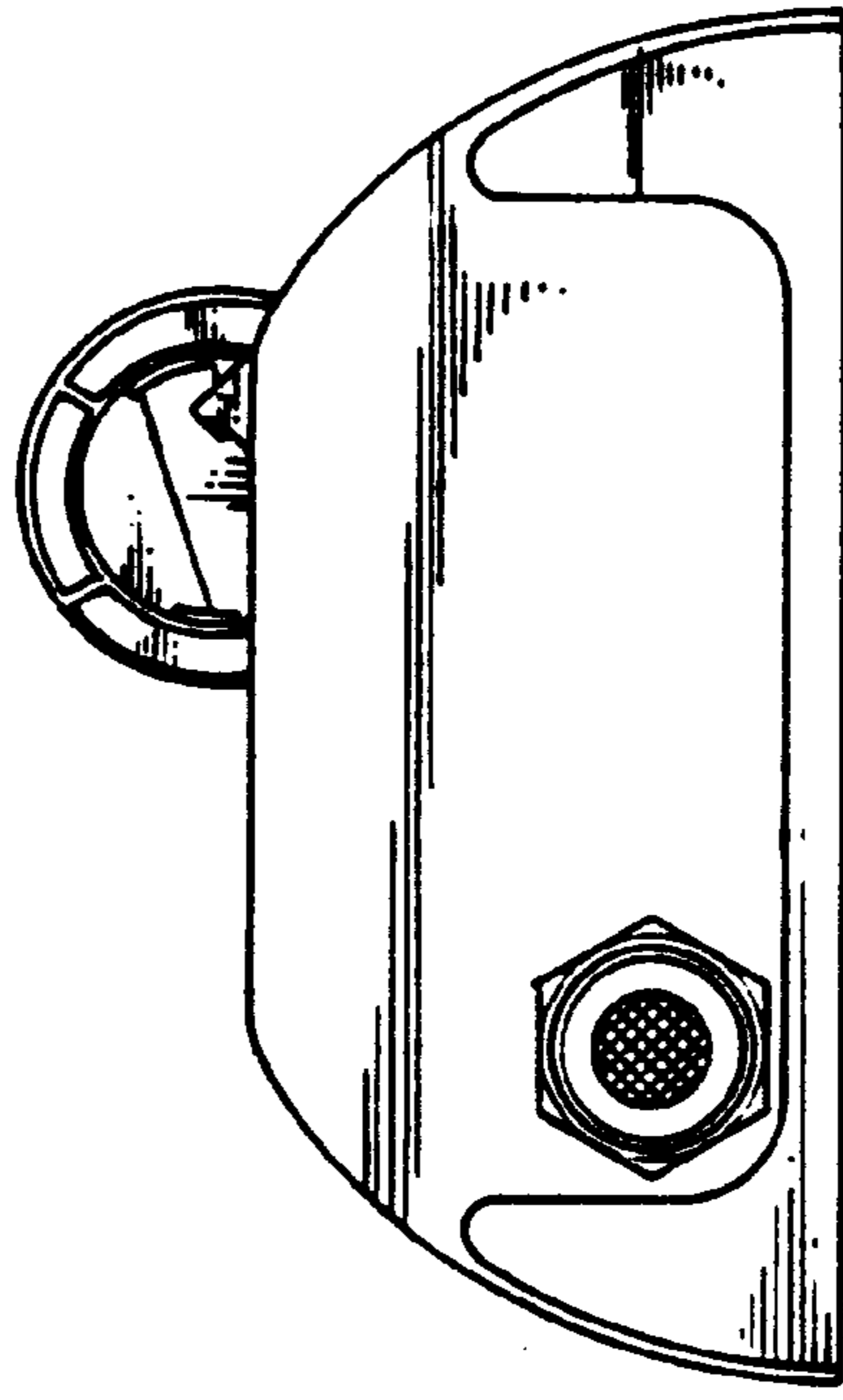

FIG. 7