



US00D427175S

United States Patent [19] Ishii

[11] **Patent Number: Des. 427,175**
[45] **Date of Patent: ** Jun. 27, 2000**

[54] **TAPE PLAYER**

[75] Inventor: **Daisuke Ishii**, Tokyo, Japan

[73] Assignee: **Sony Corporation**, Tokyo, Japan

[**] Term: **14 Years**

[21] Appl. No.: **29/107,536**

[22] Filed: **Jul. 2, 1999**

D. 347,846	6/1994	Iribe et al.	D14/165
D. 349,114	7/1994	Nakamura	D14/163
D. 370,912	6/1996	Ohba et al.	D14/165
D. 374,231	10/1996	Matsuzaka	D14/163
5,452,274	9/1995	Thompson	D14/163 X

OTHER PUBLICATIONS

Design 460, p. 24, Sharp tape recorder, Apr. 1987.

Primary Examiner—Nanda Bondade
Attorney, Agent, or Firm—Foley & Lardner

Related U.S. Application Data

[60] Division of application No. 29/077,875, Oct. 10, 1997, Pat. No. Des. 421,753, which is a continuation-in-part of application No. 29/065,282, Jan. 31, 1997, abandoned, which is a continuation-in-part of application No. 29/065,286, Jan. 31, 1997, abandoned, which is a continuation-in-part of application No. 29/065,287, Jan. 31, 1997, abandoned.

[51] **LOC (7) Cl.** **14-01**

[52] **U.S. Cl.** **D14/165**

[58] **Field of Search** D14/124, 160–165,
D14/188, 192–198; 455/344, 347–351

[56] References Cited

U.S. PATENT DOCUMENTS

D. 305,762	1/1990	Yoda et al.	D14/163
D. 312,638	12/1990	Hino et al.	D14/161 X
D. 319,238	8/1991	Taniguchi	D14/161 X
D. 330,552	10/1992	Tsuchiya	D14/165
D. 336,297	6/1993	Sekita	D14/165

[57] CLAIM

The ornamental design for a tape player, as shown and described.

DESCRIPTION

FIG. 1 is a top, front perspective view of a tape player showing my new design;
FIG. 2 is a top, rear perspective view thereof wherein the cover portion is in the open position;
FIG. 3 is a top plan view thereof;
FIG. 4 is a left side elevational view thereof;
FIG. 5 is a front elevational view thereof;
FIG. 6 is a right side elevational view thereof;
FIG. 7 is a bottom plan view thereof; and,
FIG. 8 is a rear elevational view thereof.

The remaining views of the inside of the tape player which are not visible in FIG. 2 form no part of the claimed design.

1 Claim, 4 Drawing Sheets

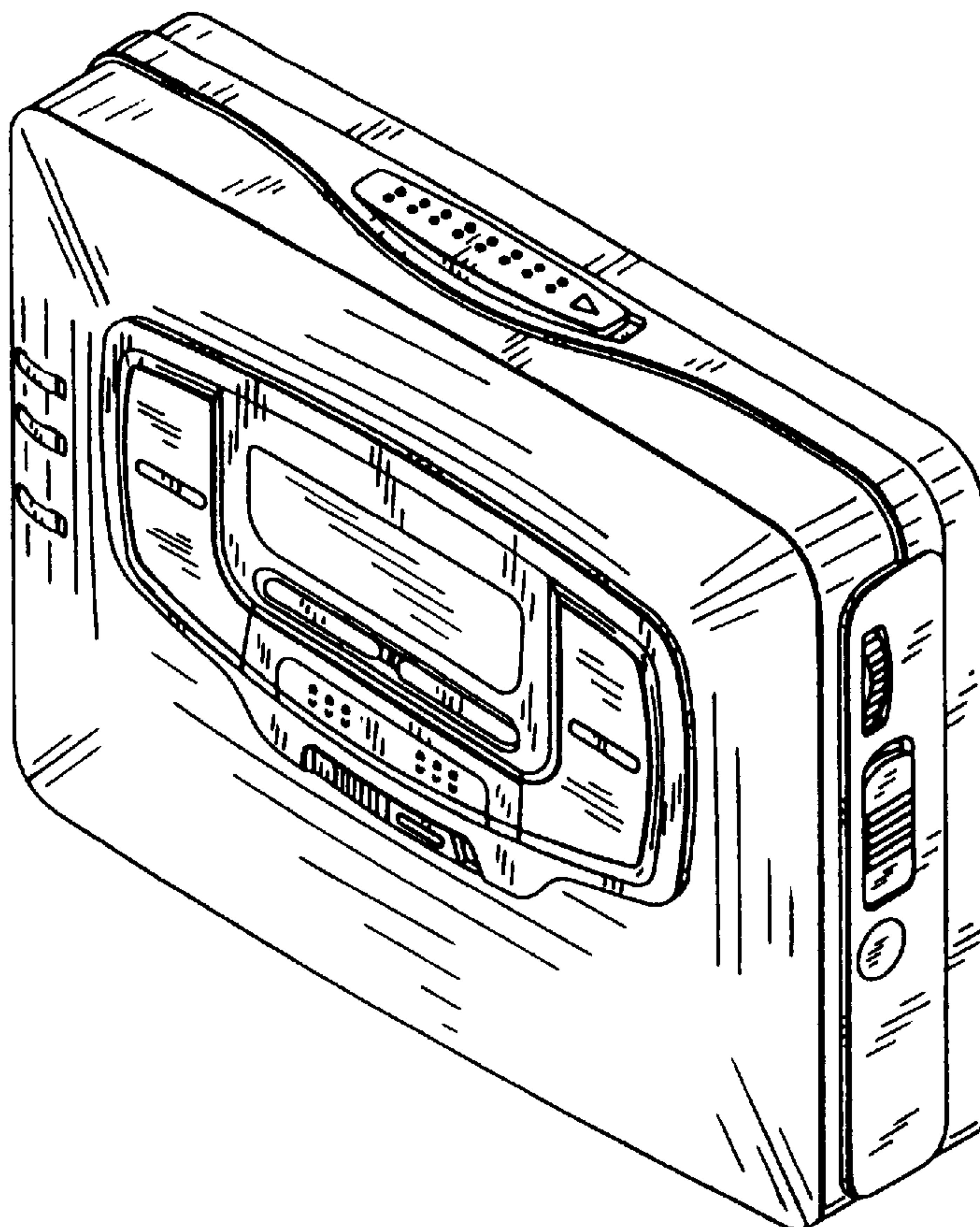

FIG. 1

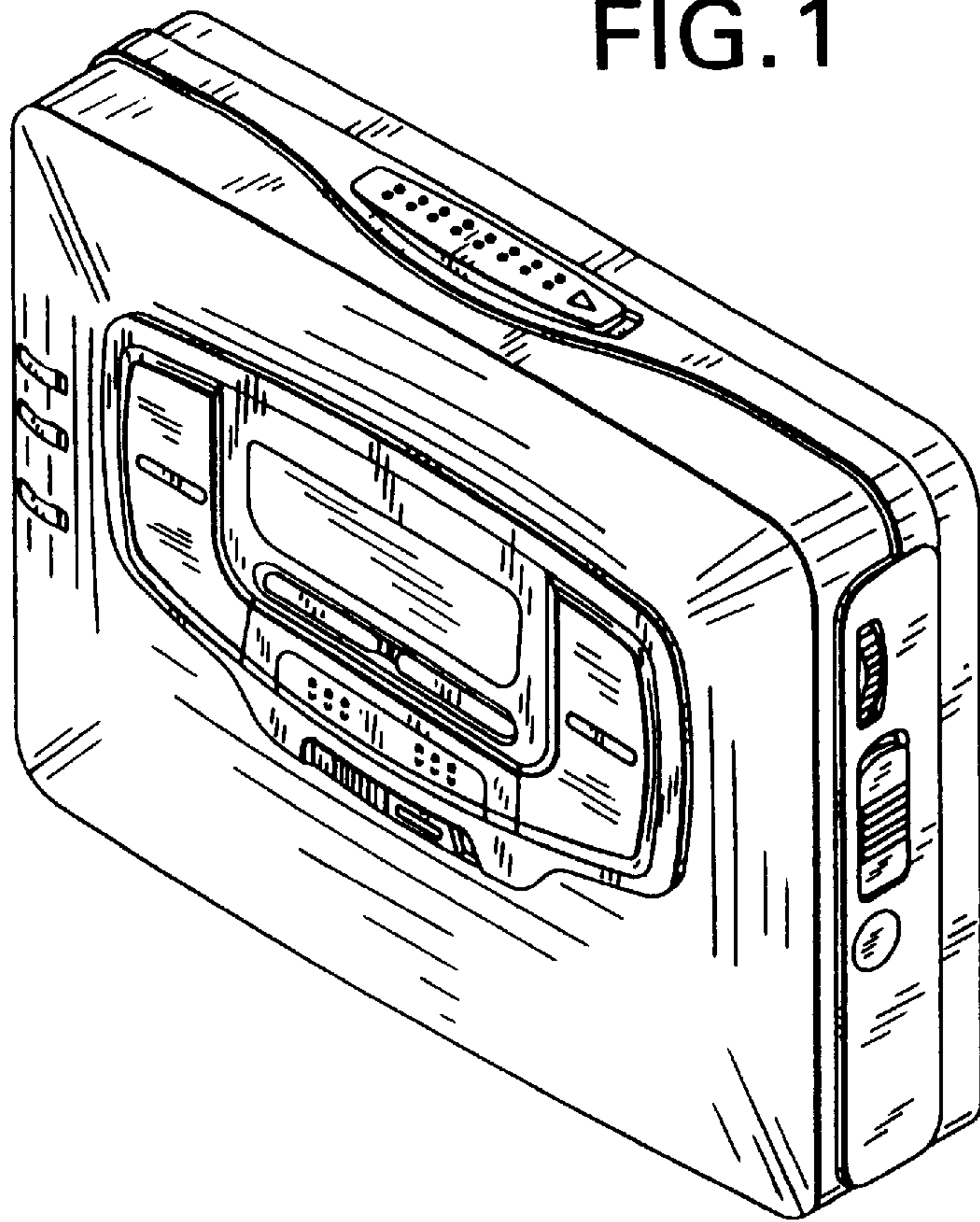

FIG. 2

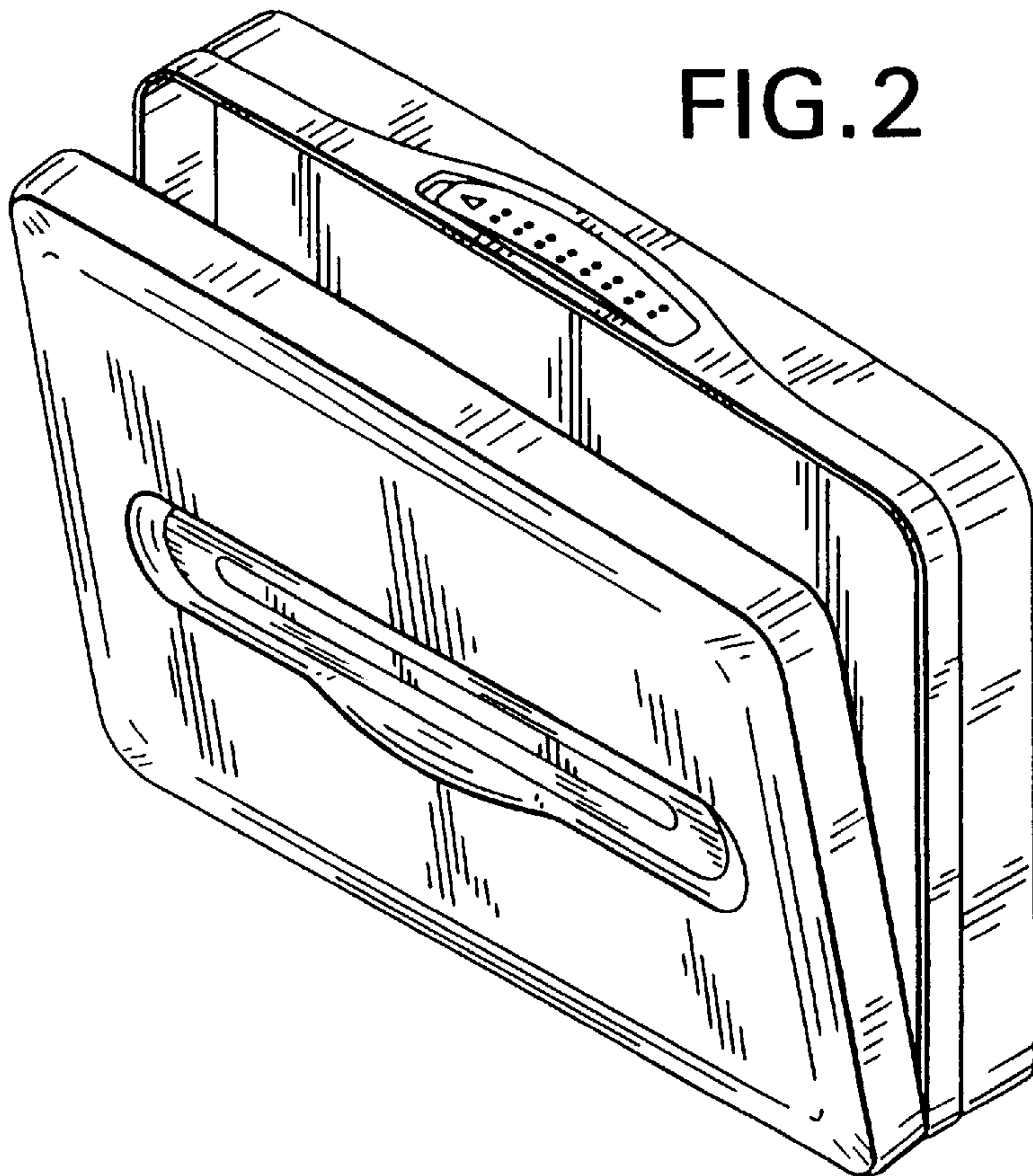

FIG. 3

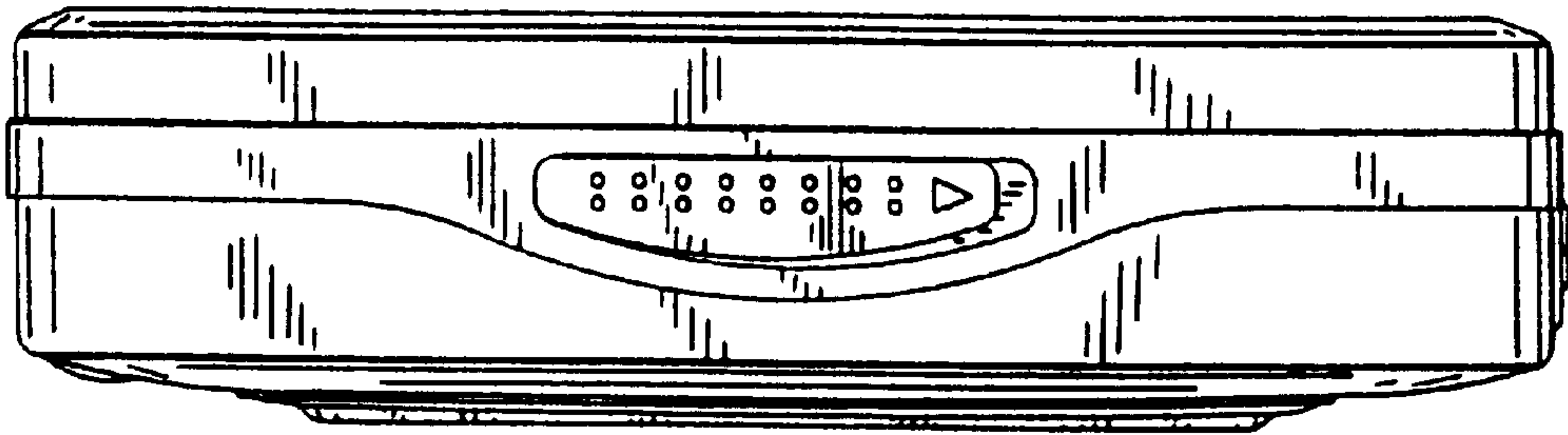

FIG. 5

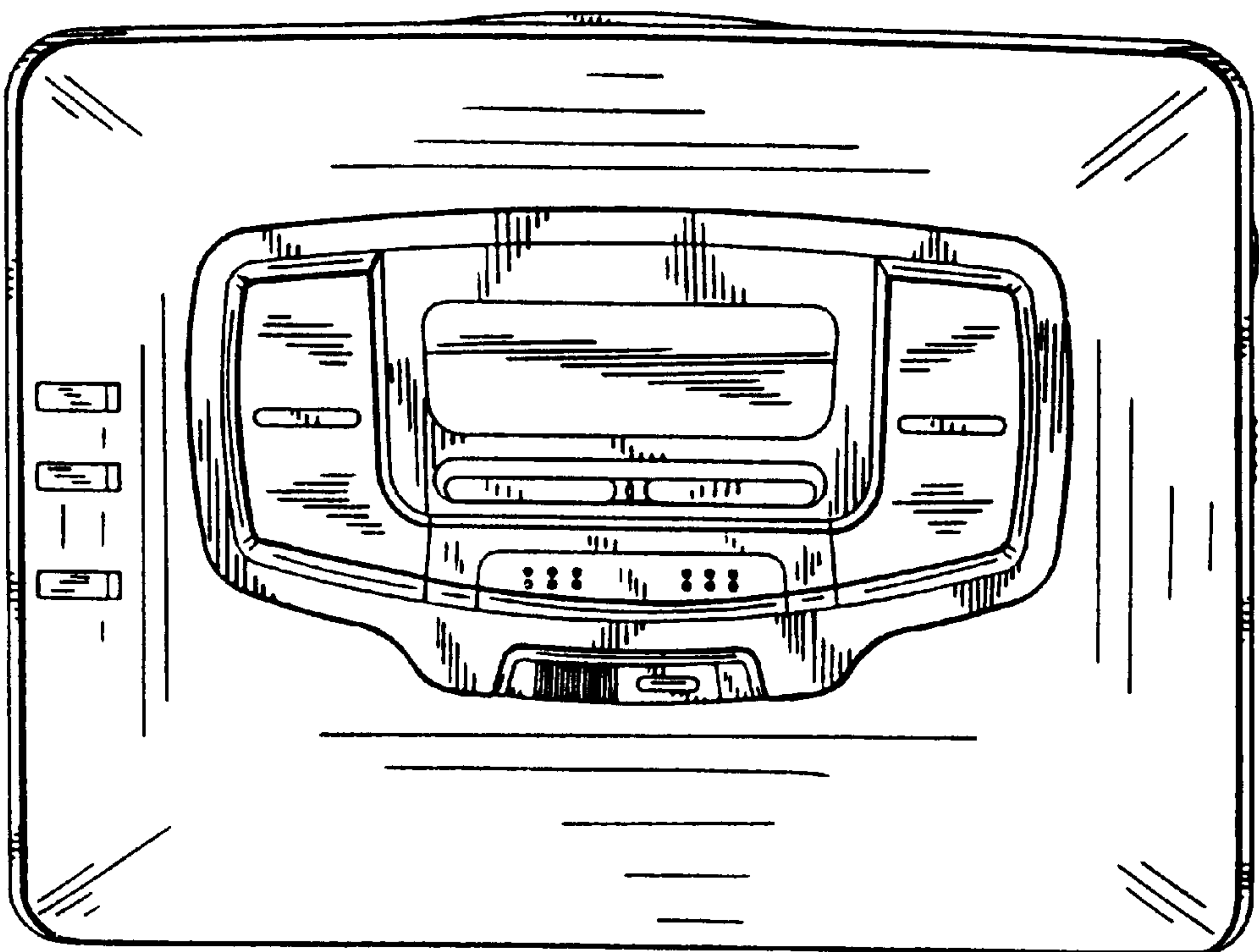

FIG. 4

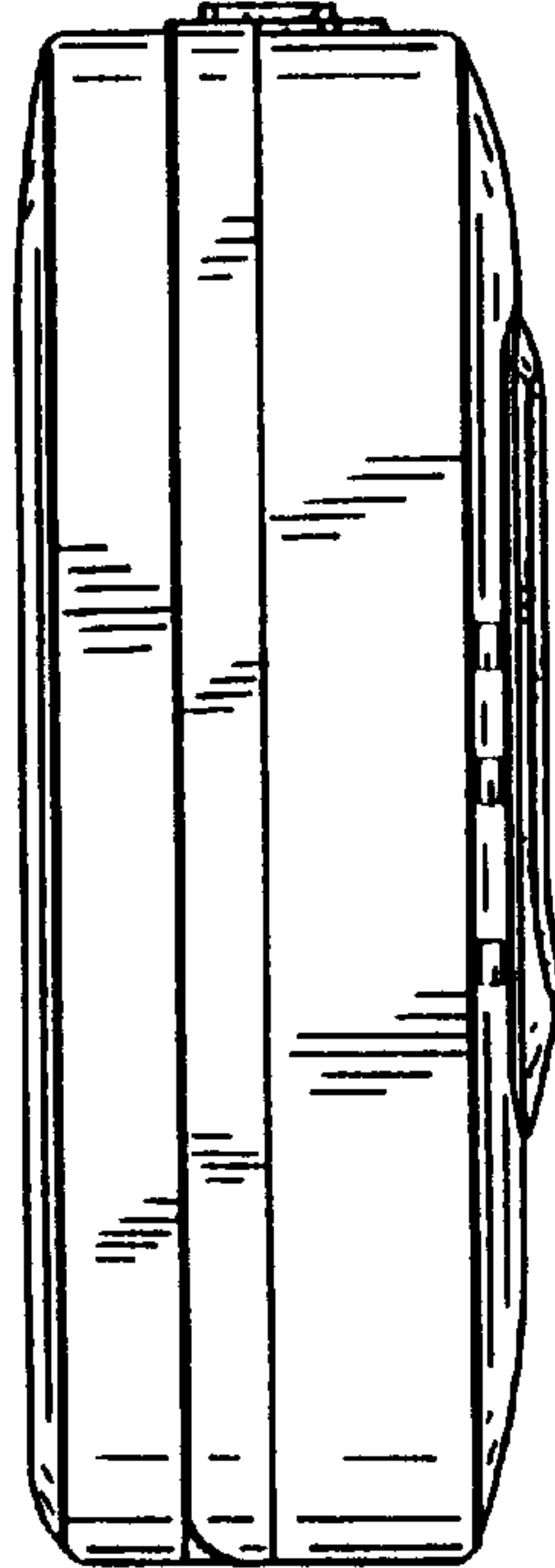

FIG. 6

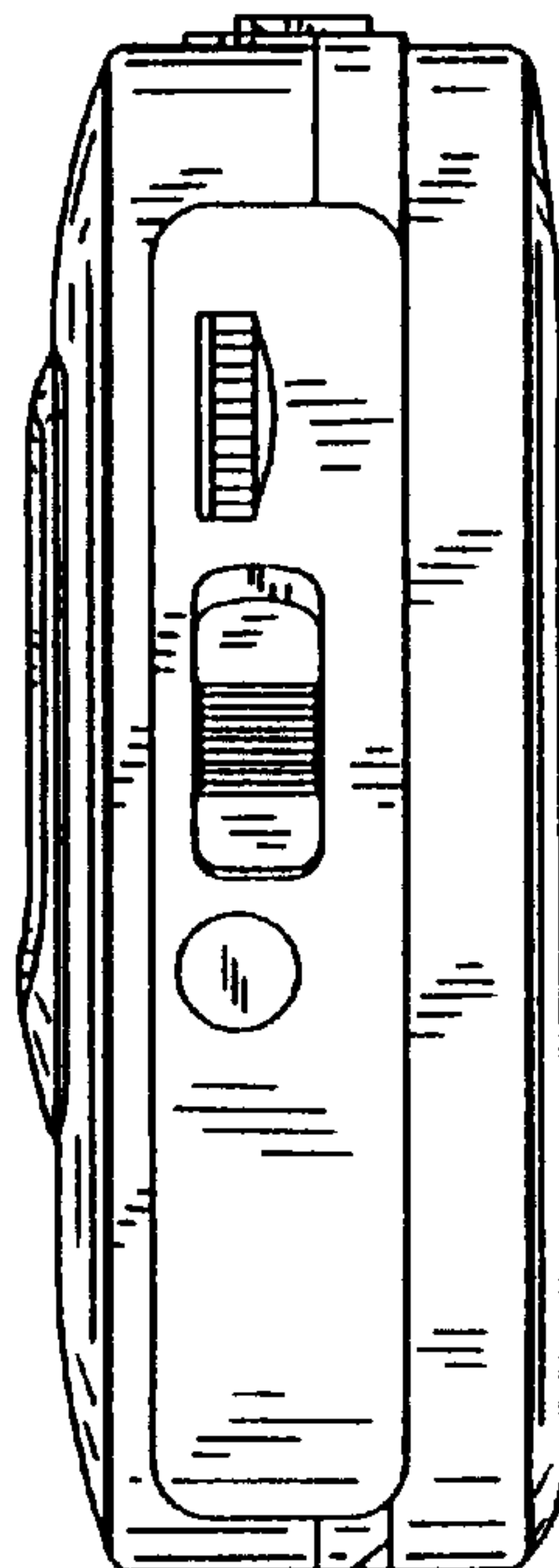

FIG. 7

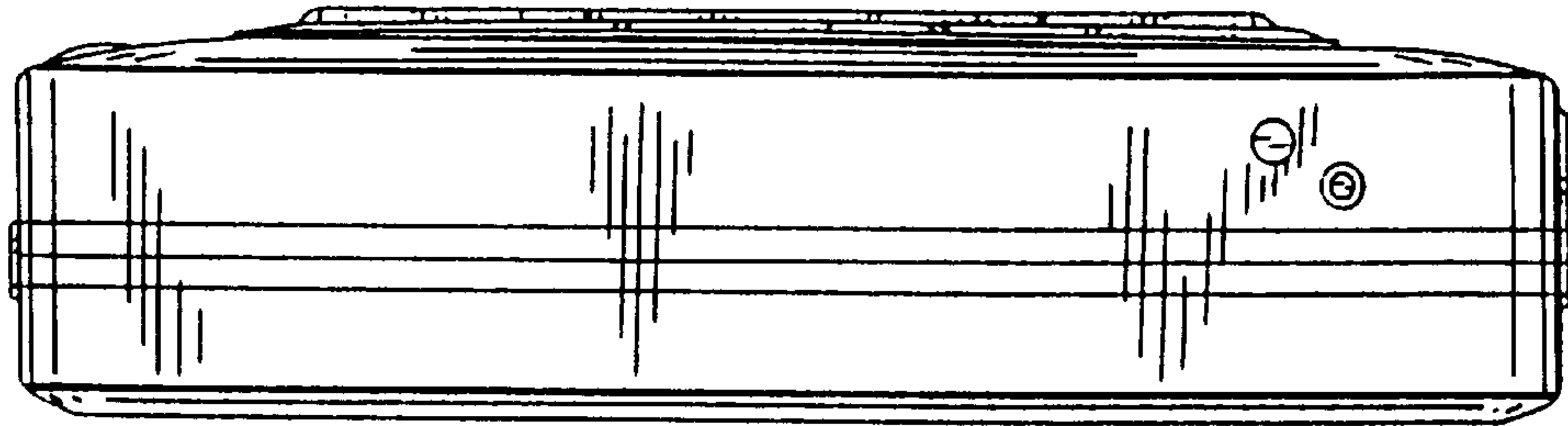

FIG. 8

