



US00D427091S

**United States Patent** [19]  
**Suurmeijer**

[11] **Patent Number: Des. 427,091**  
[45] **Date of Patent: \*\* Jun. 27, 2000**

[54] **ELECTRICAL PROBE**

D. 409,930 5/1999 Suurmeijer .  
5,898,299 3/1994 Fodali ..... 324/149

[75] Inventor: **Christian Peter Suurmeijer,**  
Amersfoort, Netherlands

*Primary Examiner*—Antoine Duval Davis  
*Attorney, Agent, or Firm*—George T. Noe

[73] Assignee: **Fluke Corporation,** Everett, Wash.

[57] **CLAIM**

[\*\*] Term: **14 Years**

The ornamental design for an electrical probe, as shown and described.

[21] Appl. No.: **29/113,180**

**DESCRIPTION**

[22] Filed: **Oct. 29, 1999**

[51] **LOC (7) Cl.** ..... **10-04**

[52] **U.S. Cl.** ..... **D10/78**

[58] **Field of Search** ..... D10/78; 324/72.5,  
324/149, 156, 508, 509, 538; 340/815.74

FIG. 1 is a perspective view of a an embodiment of an electrical probe showing my new design;  
FIG. 2 is a left side elevation view thereof;  
FIG. 3 is a front elevation view thereof;  
FIG. 4 is a top plan view thereof;  
FIG. 5 is a rear elevation view thereof;  
FIG. 6 is a right side elevation view thereof; and,  
FIG. 7 is a bottom plan view thereof.  
The broken line showing is for illustrative purposes only and forms no part of the claimed design.

[56] **References Cited**

**U.S. PATENT DOCUMENTS**

- D. 344,681 3/1994 Nightinggale et al. .... D10/78
- D. 346,122 4/1994 Nightinggale et al. .... D10/78
- D. 409,929 5/1999 Fisher et al. .... D10/78

**1 Claim, 1 Drawing Sheet**

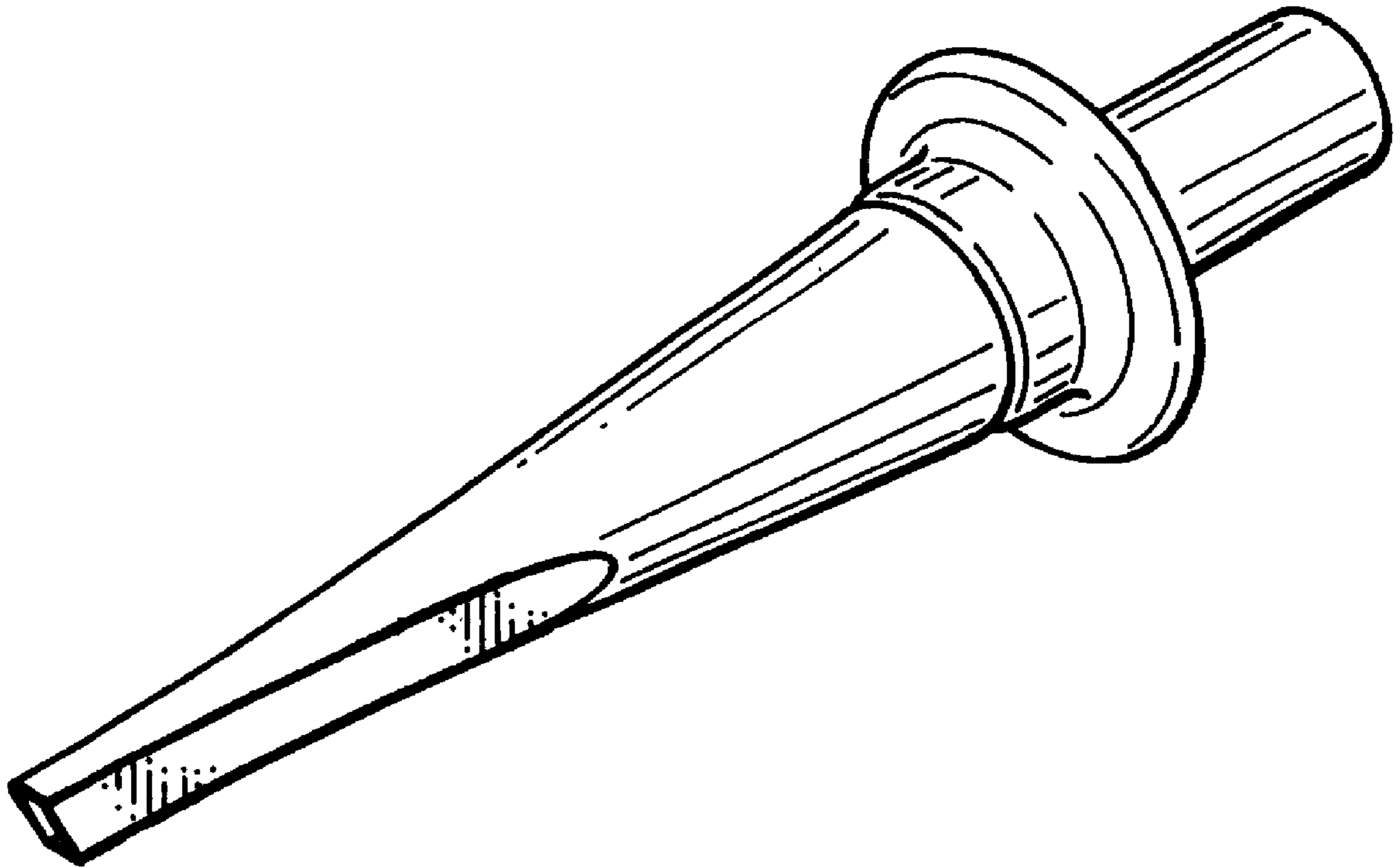

FIG. 1

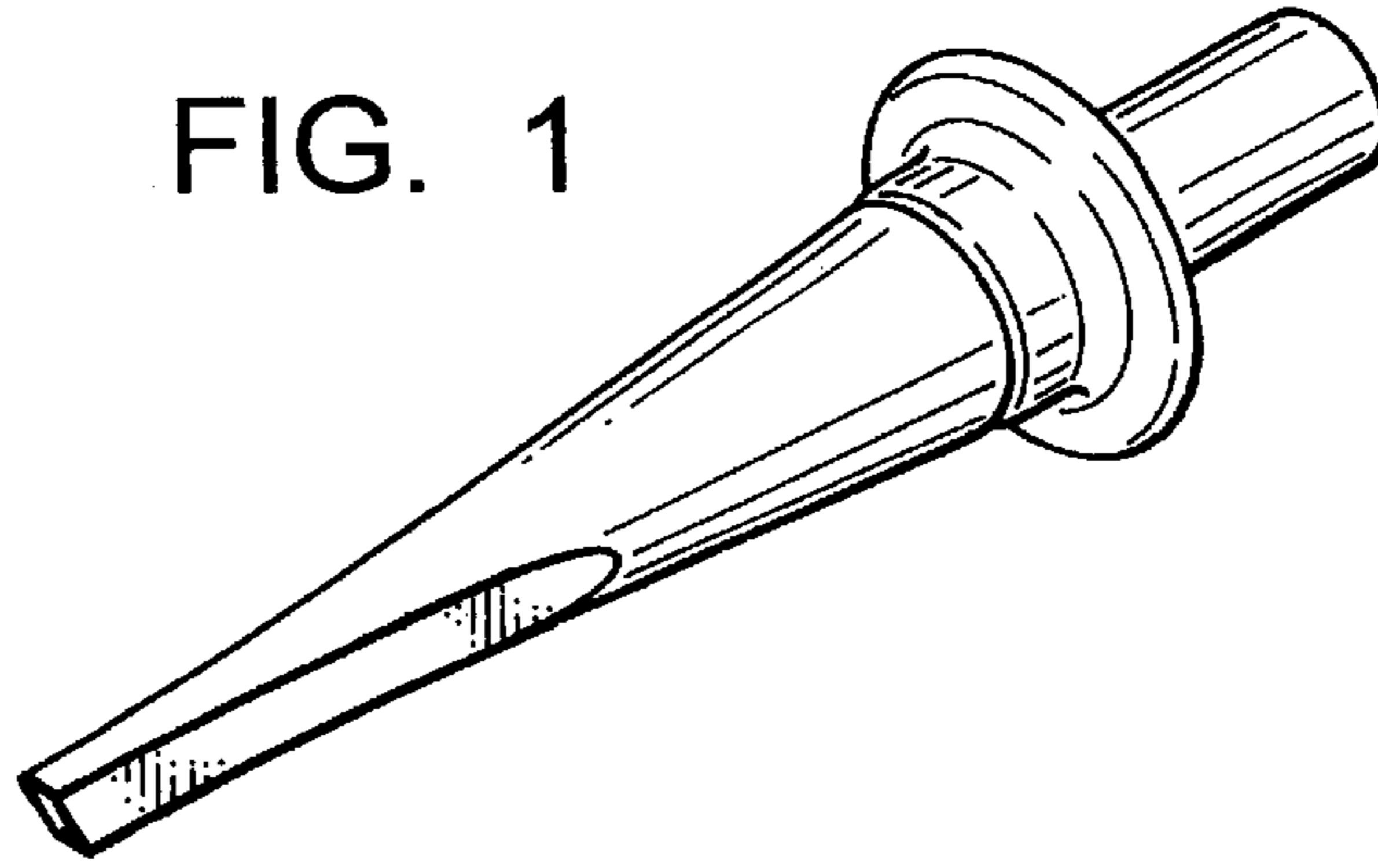

FIG. 2

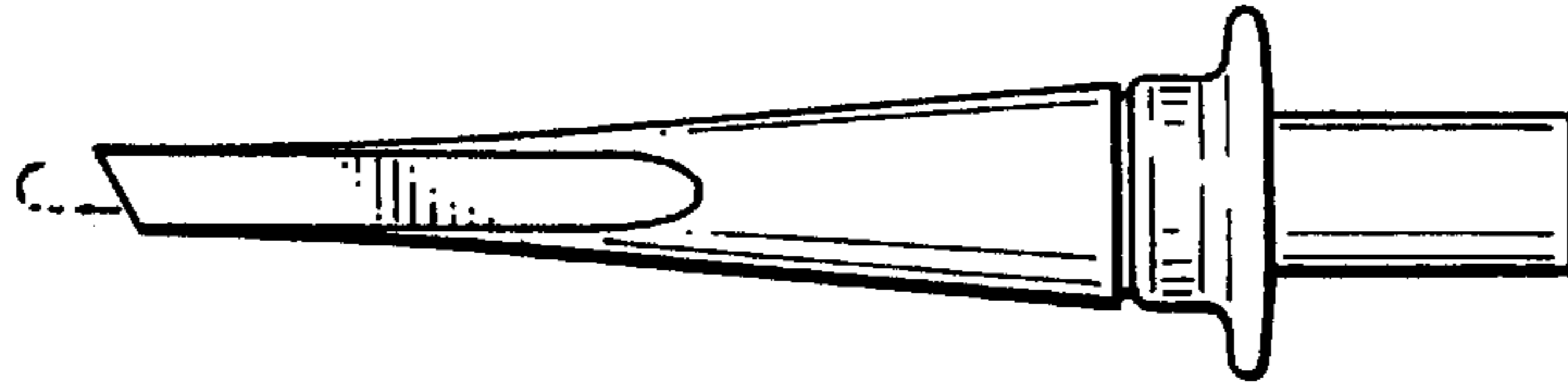

FIG. 3

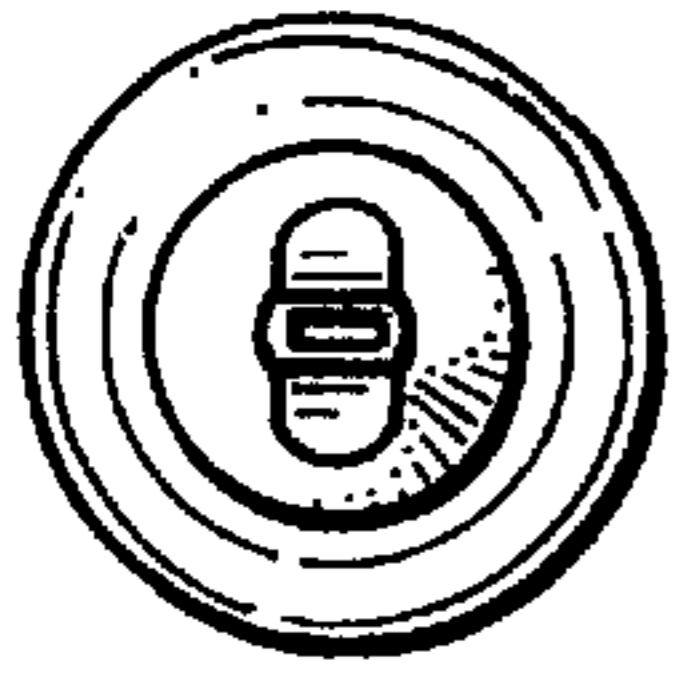

FIG. 4

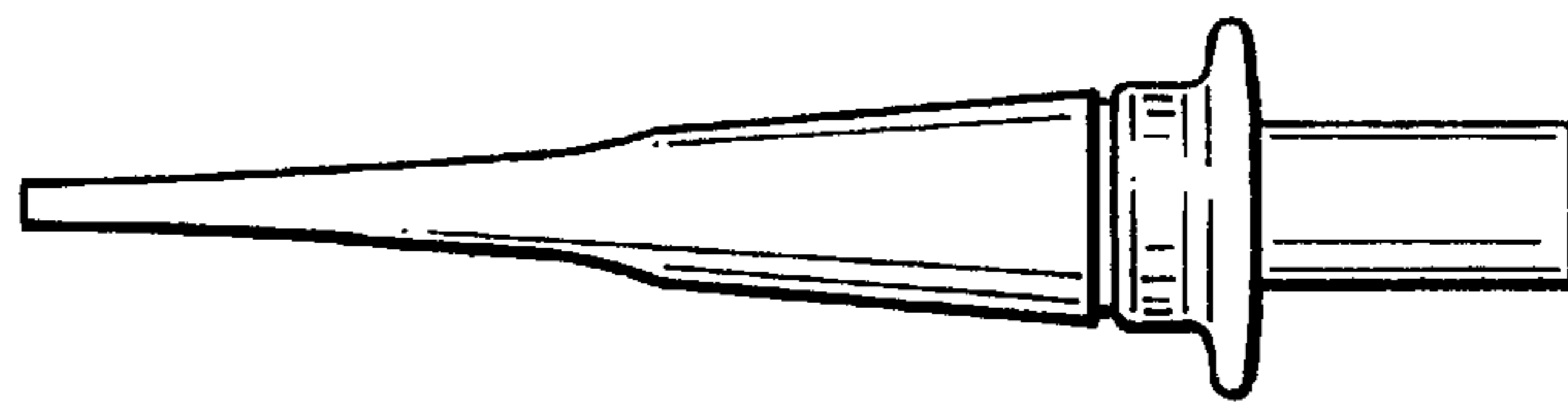

FIG. 5

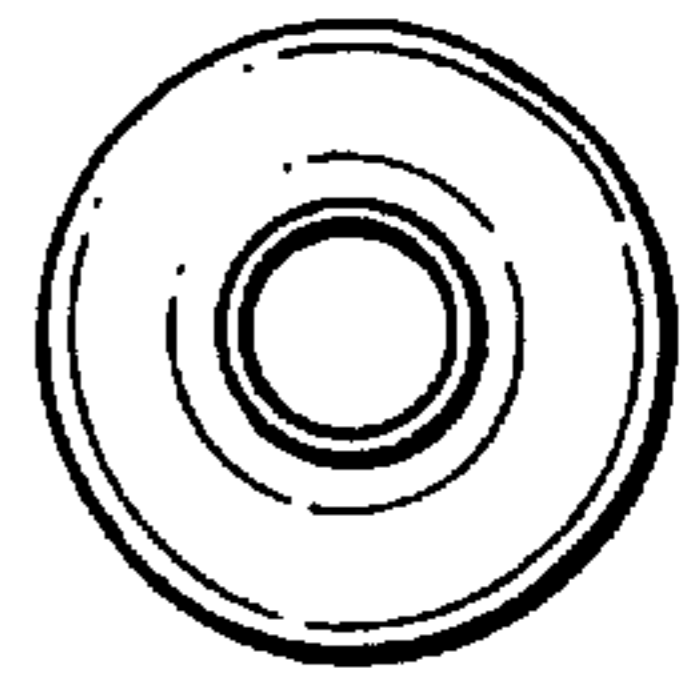

FIG. 6

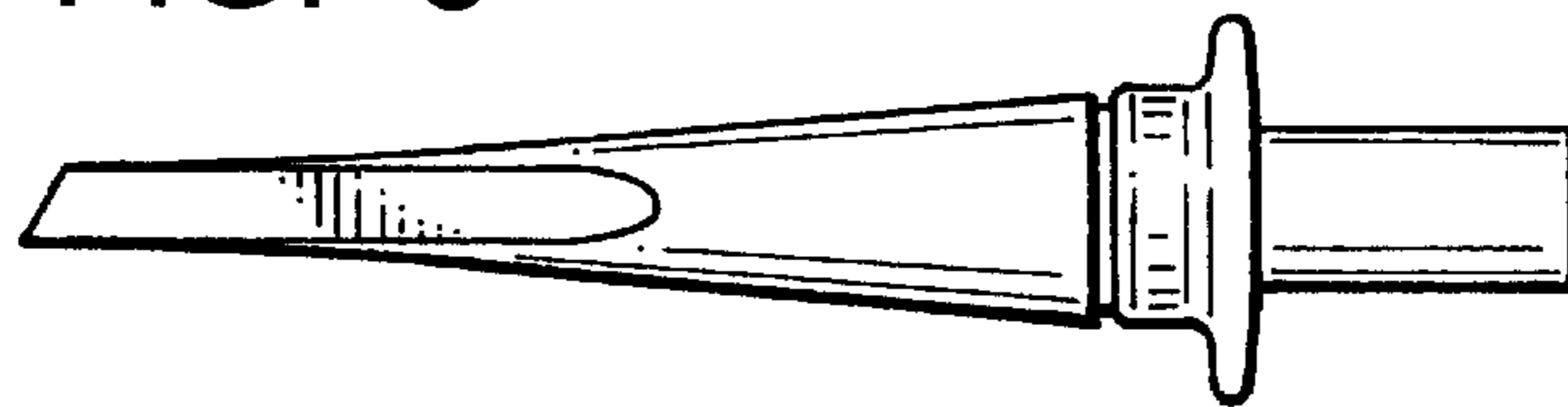

FIG. 7

