



US00D427063S

**United States Patent** [19]  
**May**

[11] **Patent Number: Des. 427,063**  
[45] **Date of Patent: \*\* Jun. 27, 2000**

[54] **DISPOSABLE CONTAINER**

[76] Inventor: **Timothy J. May**, N. 1357 Woodland Dr., Greenville, Wis. 54942

[\*\*] Term: **14 Years**

[21] Appl. No.: **29/106,501**

[22] Filed: **Jun. 16, 1999**

[51] **LOC (7) Cl.** ..... **09-07**

[52] **U.S. Cl.** ..... **D9/425; D9/432**

[58] **Field of Search** ..... D9/420-427, 431, D9/432, 414, 337, 418; 206/508, 504, 505; 229/405, 407, 4.5, 902, 162, 938, 939; 220/780, 781, 782, 783, 789, 790, 791, 793, 376, 377, 380, 556; D7/629

[56] **References Cited**

**U.S. PATENT DOCUMENTS**

D. 363,663	10/1995	Plater	.....	D9/425
D. 367,609	3/1996	Frank et al.	.....	D9/425
D. 388,325	12/1997	Tucker et al.	.....	D9/425
D. 390,109	2/1998	Tucker et al.	.....	D9/425
D. 412,439	8/1999	Cormack	.....	D9/425
2,880,859	4/1959	Tupper	.....	220/789 X
3,448,888	6/1969	Smith et al.	.....	220/781
3,452,896	7/1969	Elliot	.....	220/781
4,787,527	11/1988	Monetti	.....	220/557
5,377,860	1/1995	Littlejohn et al.	.....	220/784 X
5,624,051	4/1997	Ahern, Jr. et al.	.....	220/556 X

**OTHER PUBLICATIONS**

Packaging Corporation Booklet, Mar. 1995.

*Primary Examiner*—Prabhakar Deshmukh  
*Attorney, Agent, or Firm*—Merchant & Gould P.C.

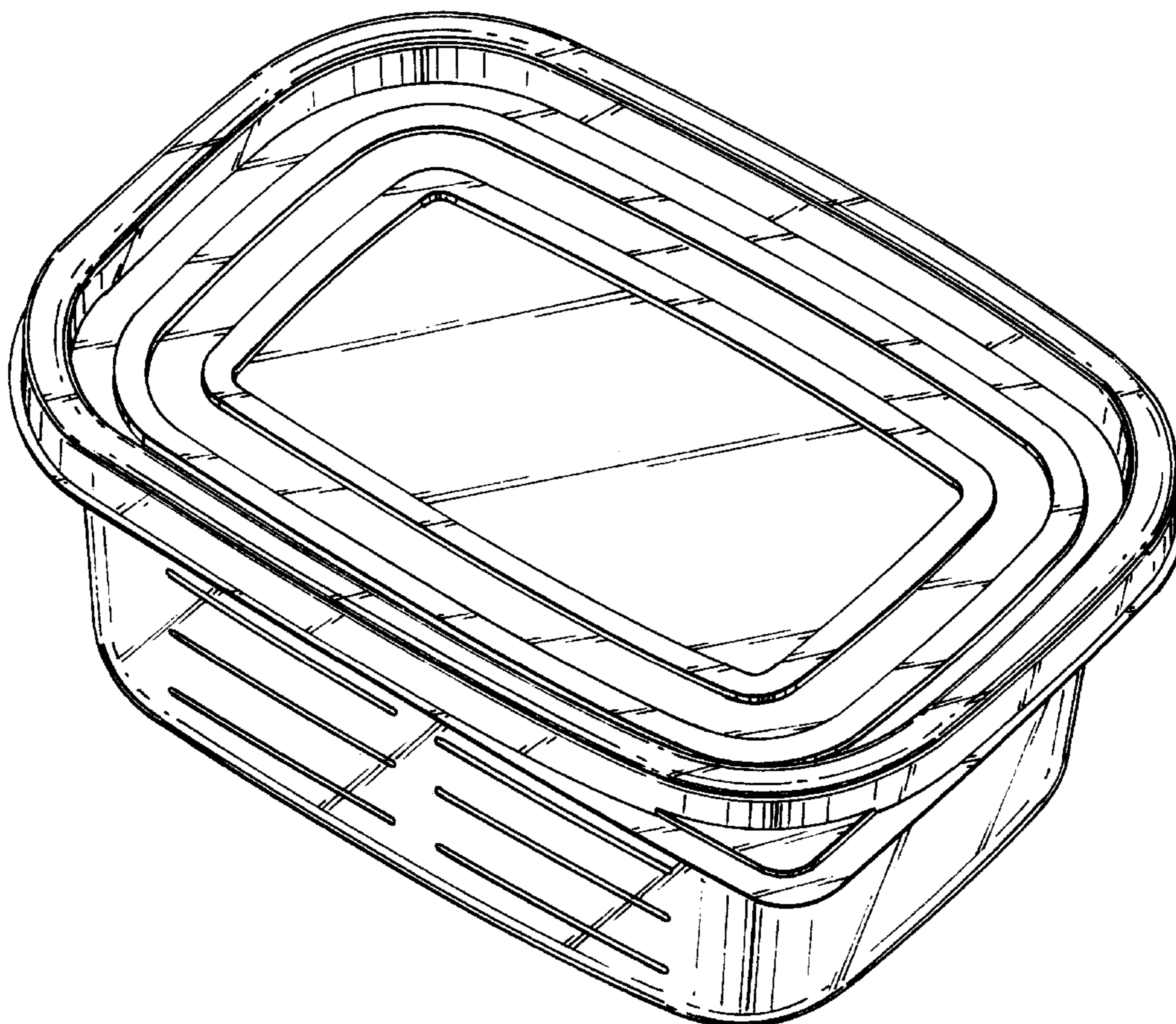
[57] **CLAIM**

The ornamental design for a disposable container, as shown and described.

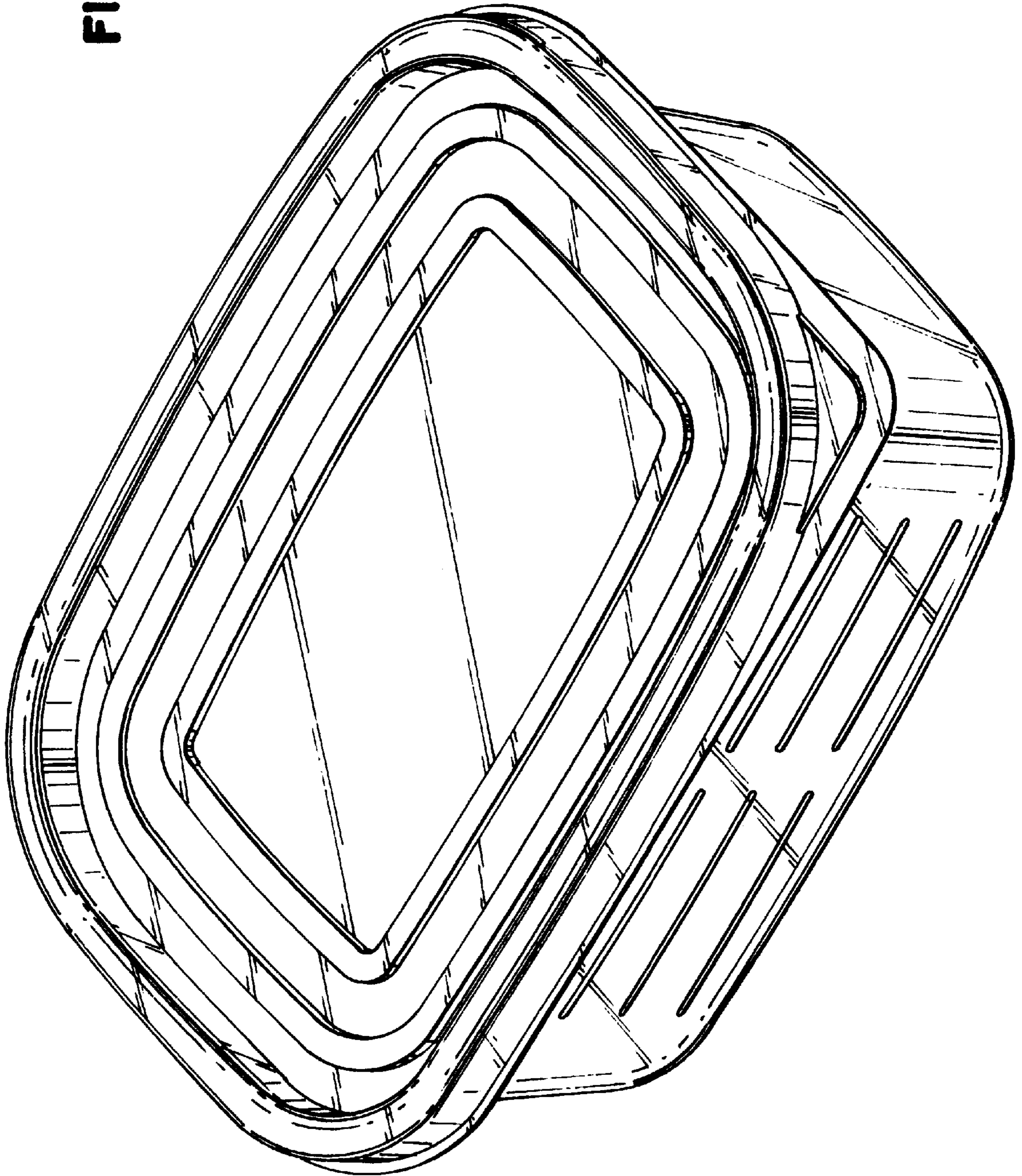
**DESCRIPTION**

FIG. 1 is a perspective view of a first embodiment of a disposable container, embodying my new design; FIG. 2 is a top plan view thereof; FIG. 3 is a front elevational view thereof; FIG. 4 is a rear elevational view thereof; FIG. 5 is a bottom plan view thereof; FIG. 6 is a right end elevational view thereof; FIG. 7 is a left end elevational view thereof; FIG. 8 is a perspective view of a second embodiment of a disposable container embodying my new design; FIG. 9 is a top plan view thereof; FIG. 10 is a front elevational view thereof; FIG. 11 is a rear elevational view thereof; FIG. 12 is a bottom plan view thereof; FIG. 13 is a right end elevational view thereof; and, FIG. 14 is a left end elevational view thereof.

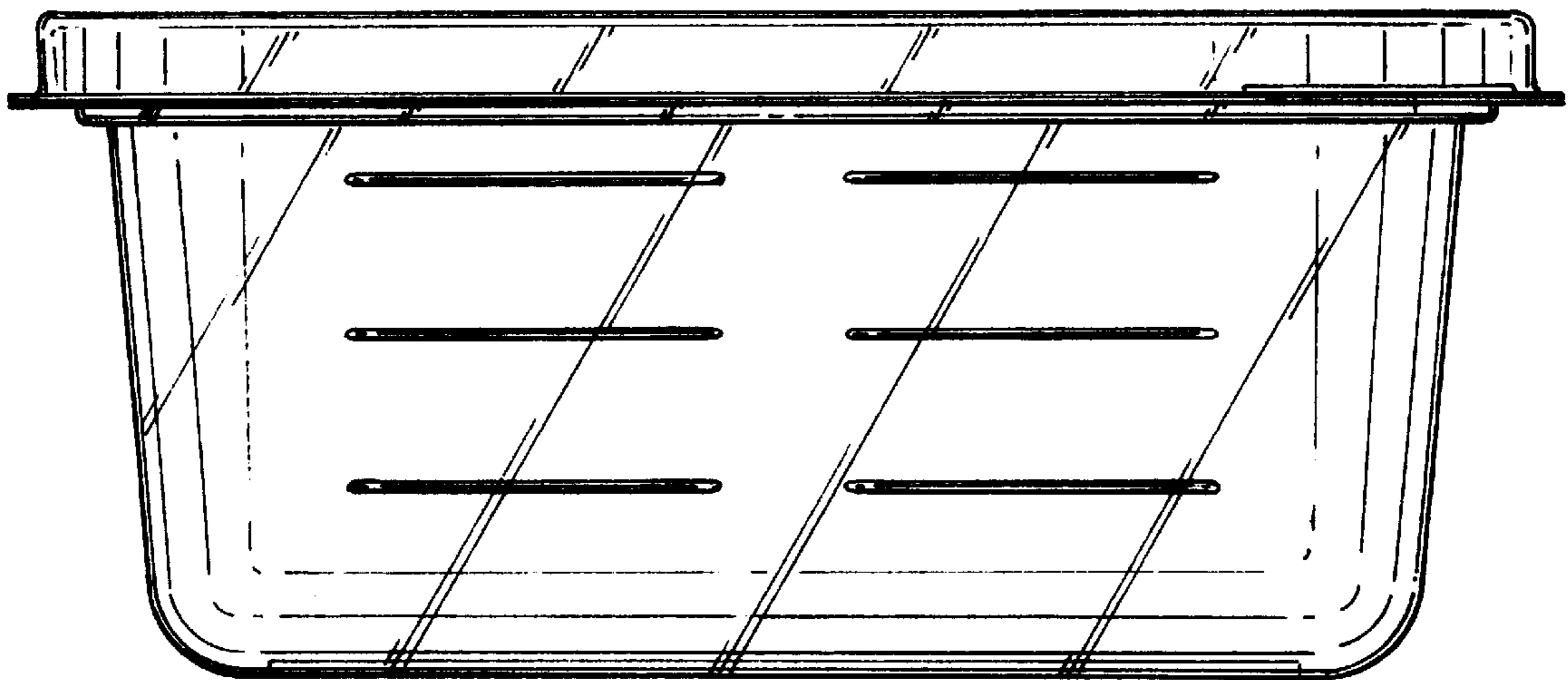
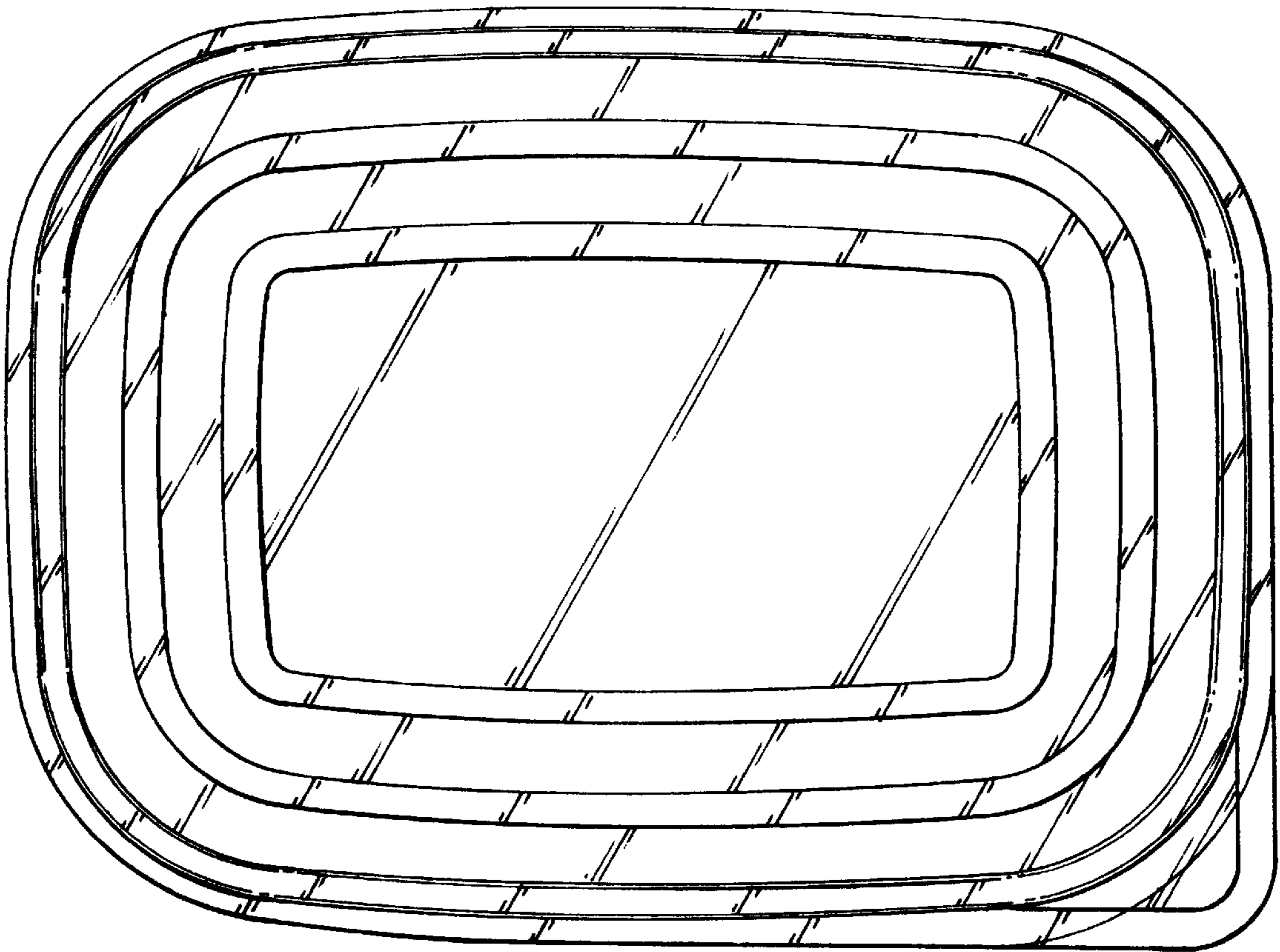
**1 Claim, 8 Drawing Sheets**



**FIG. 1**

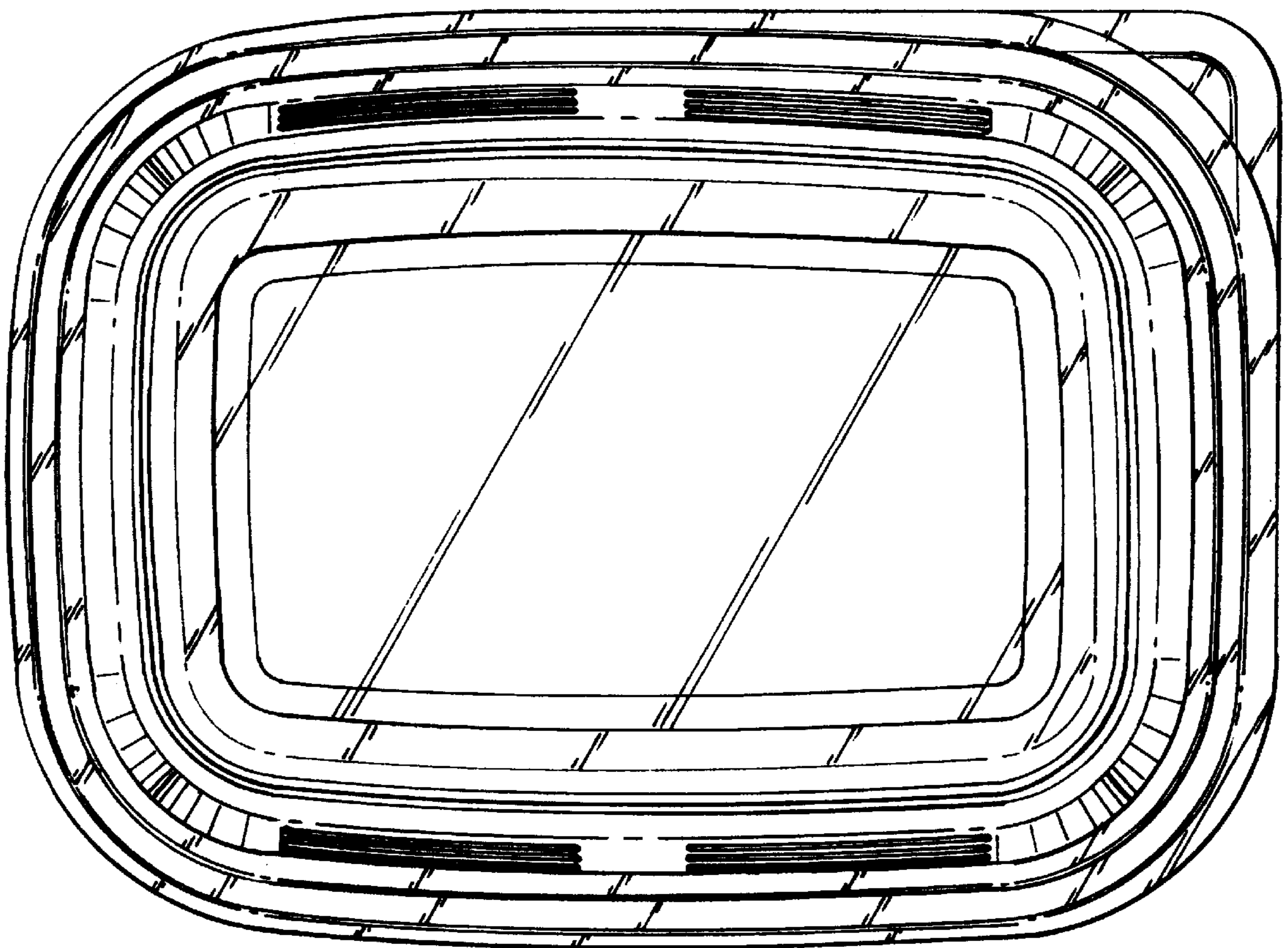
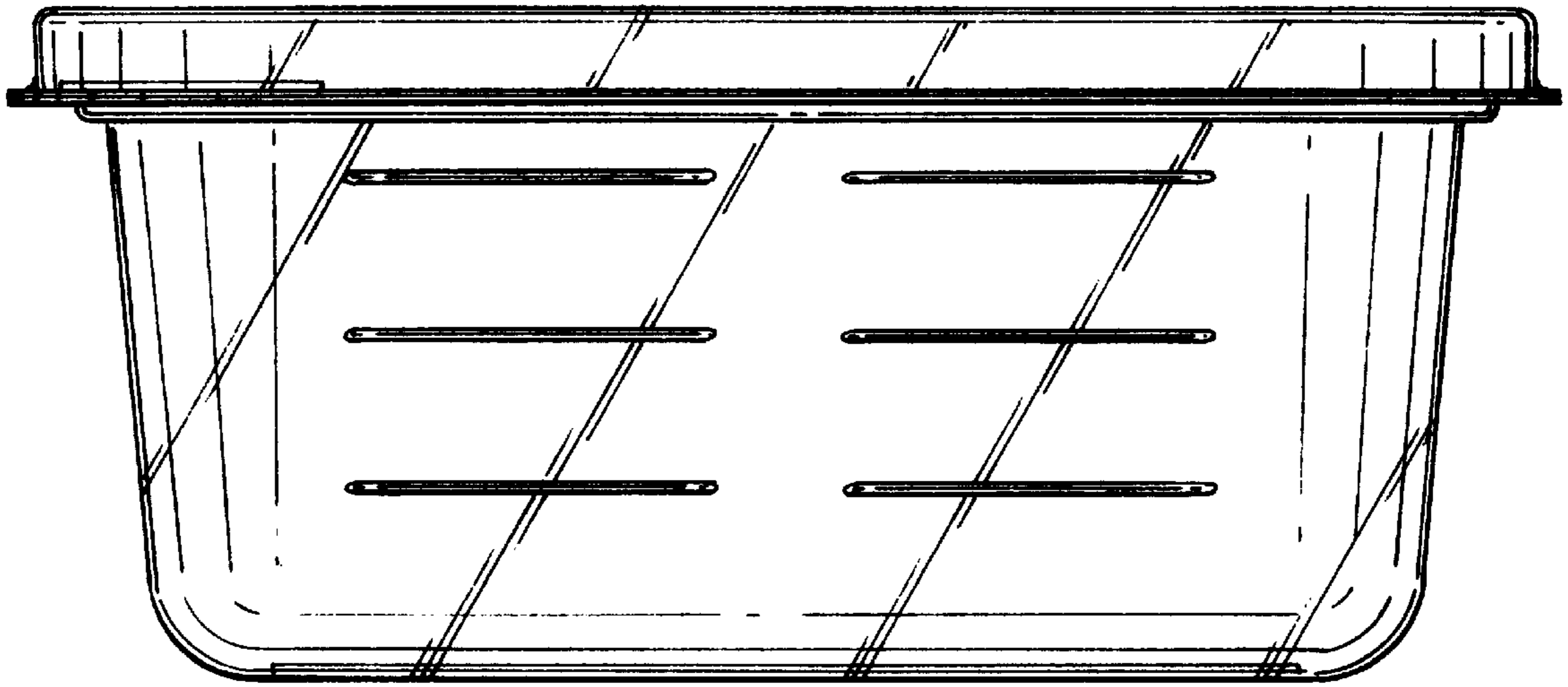


**FIG. 2**



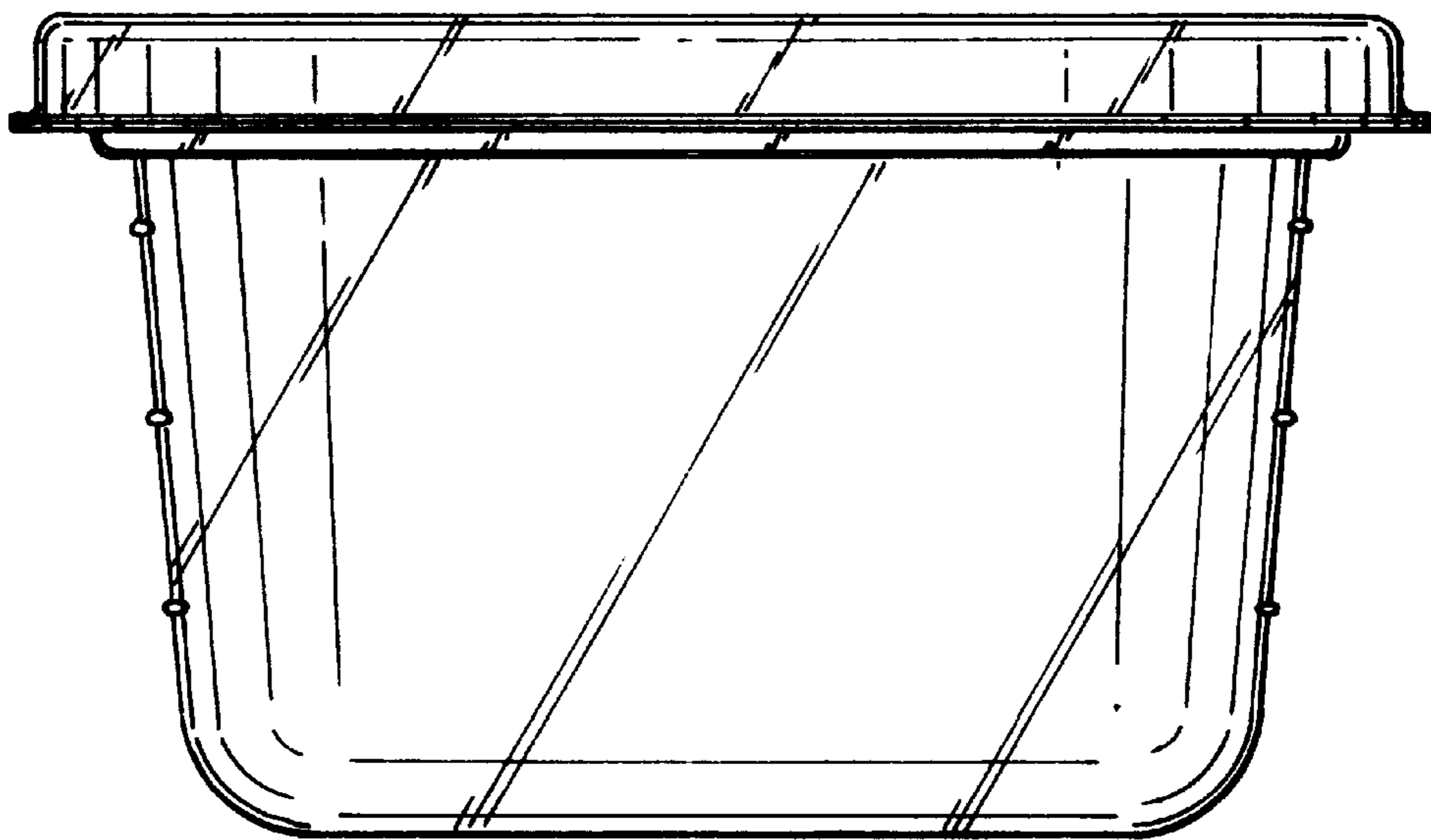
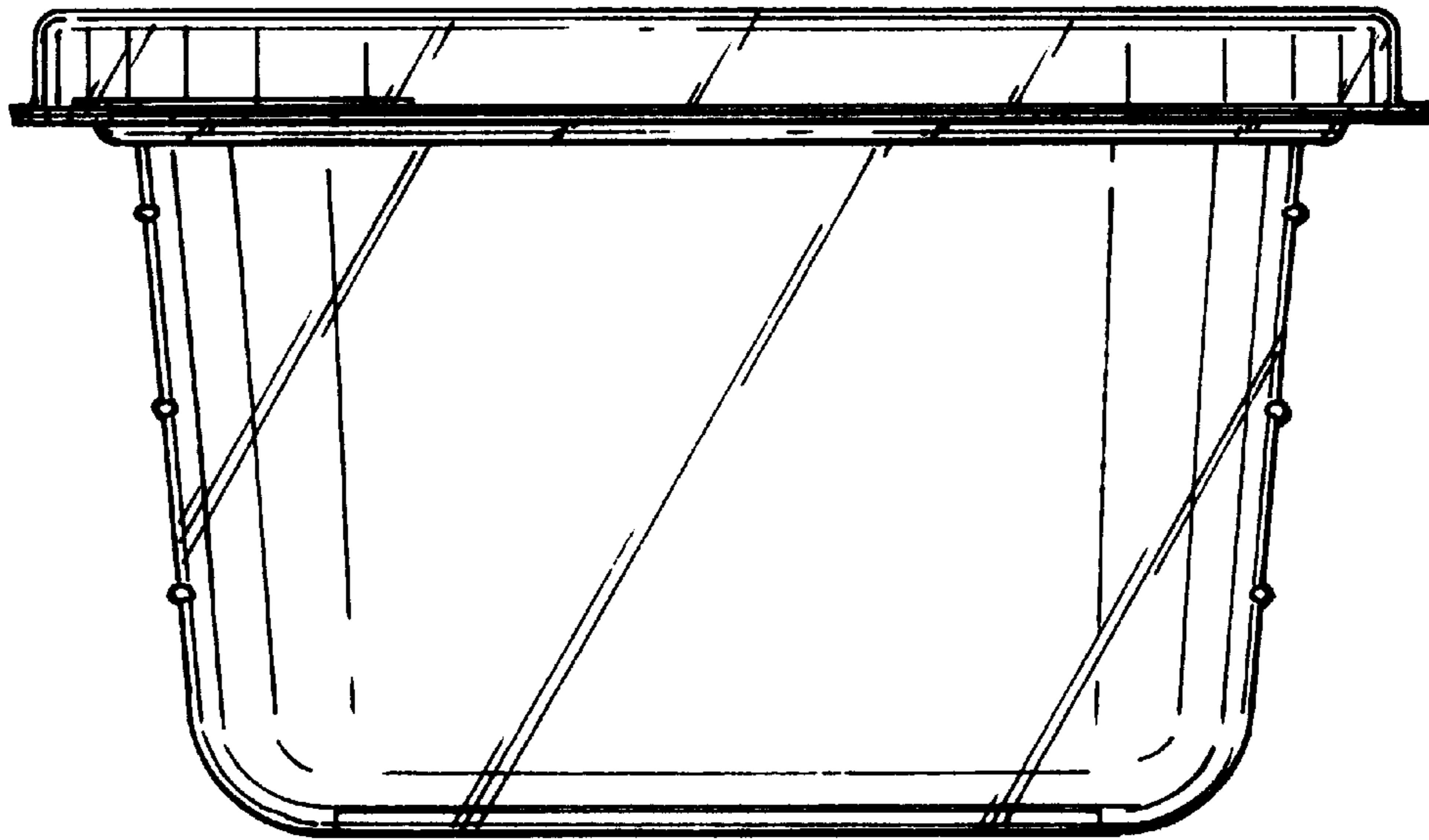
**FIG. 3**

**FIG. 4**



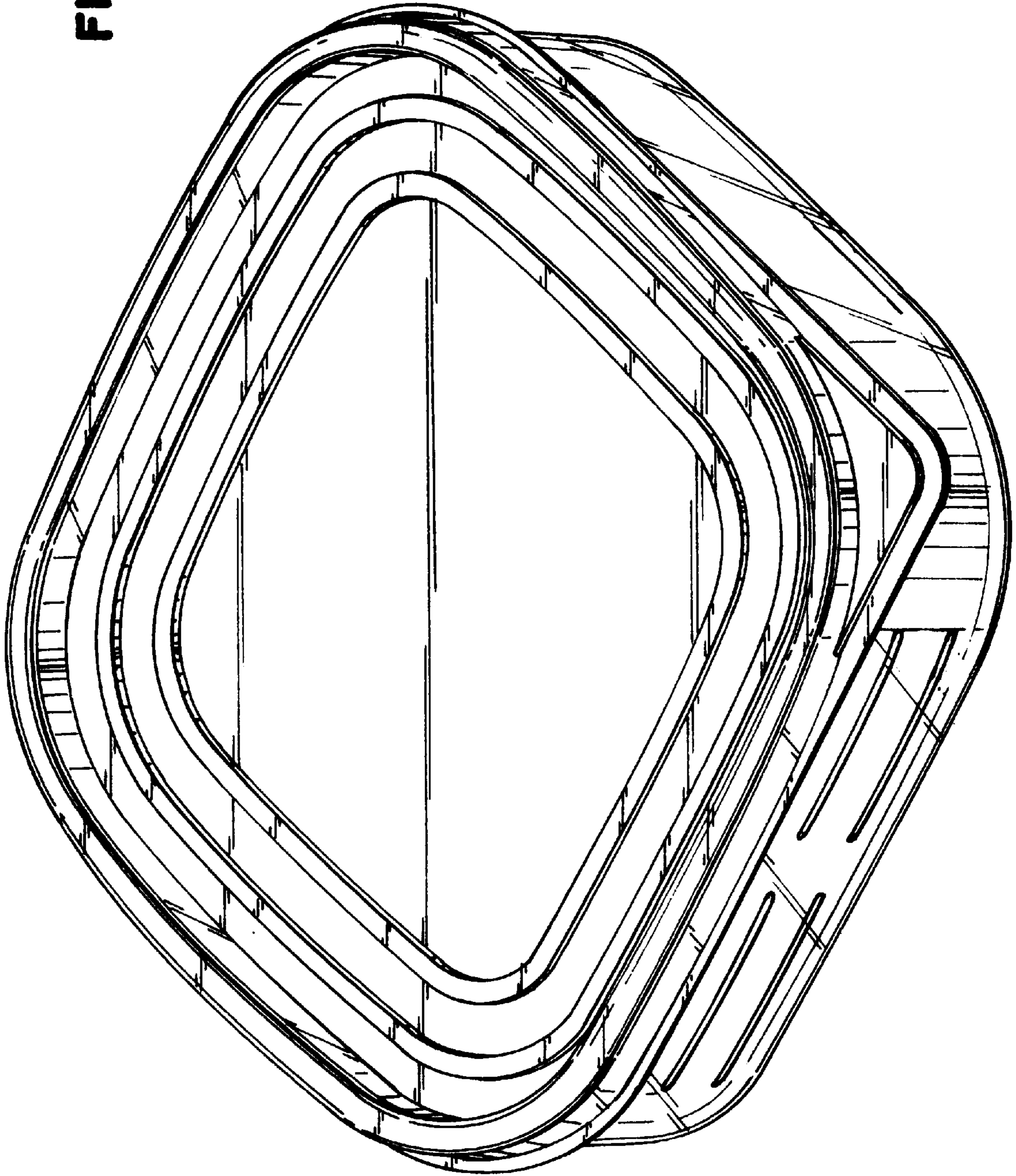
**FIG. 5**

**FIG. 6**

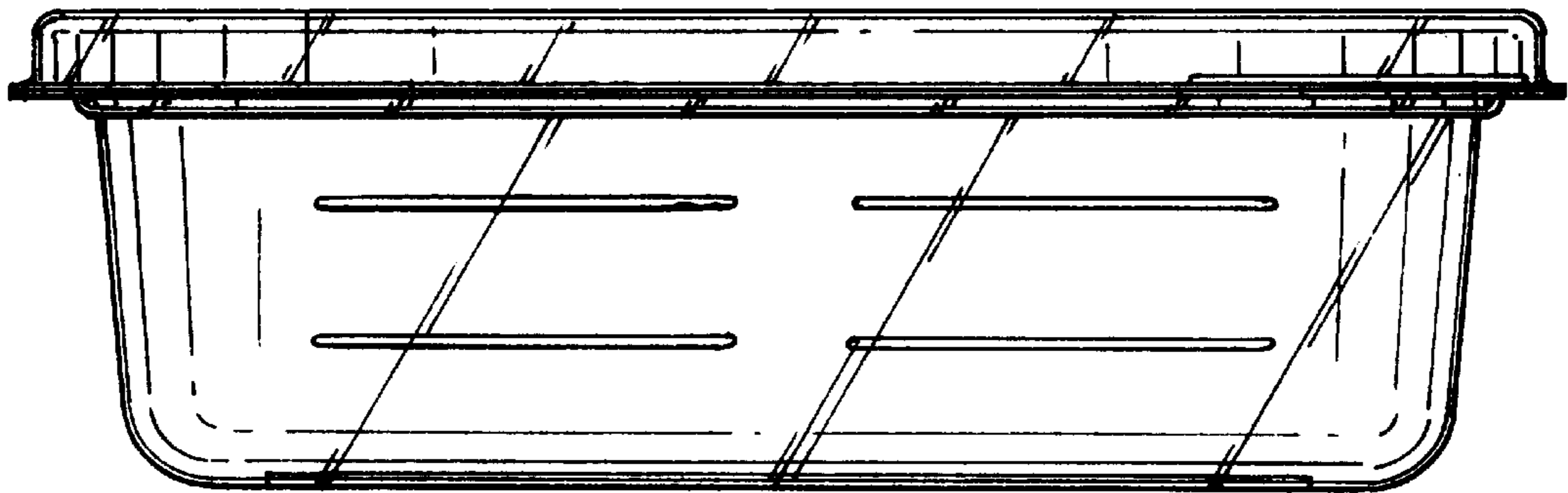
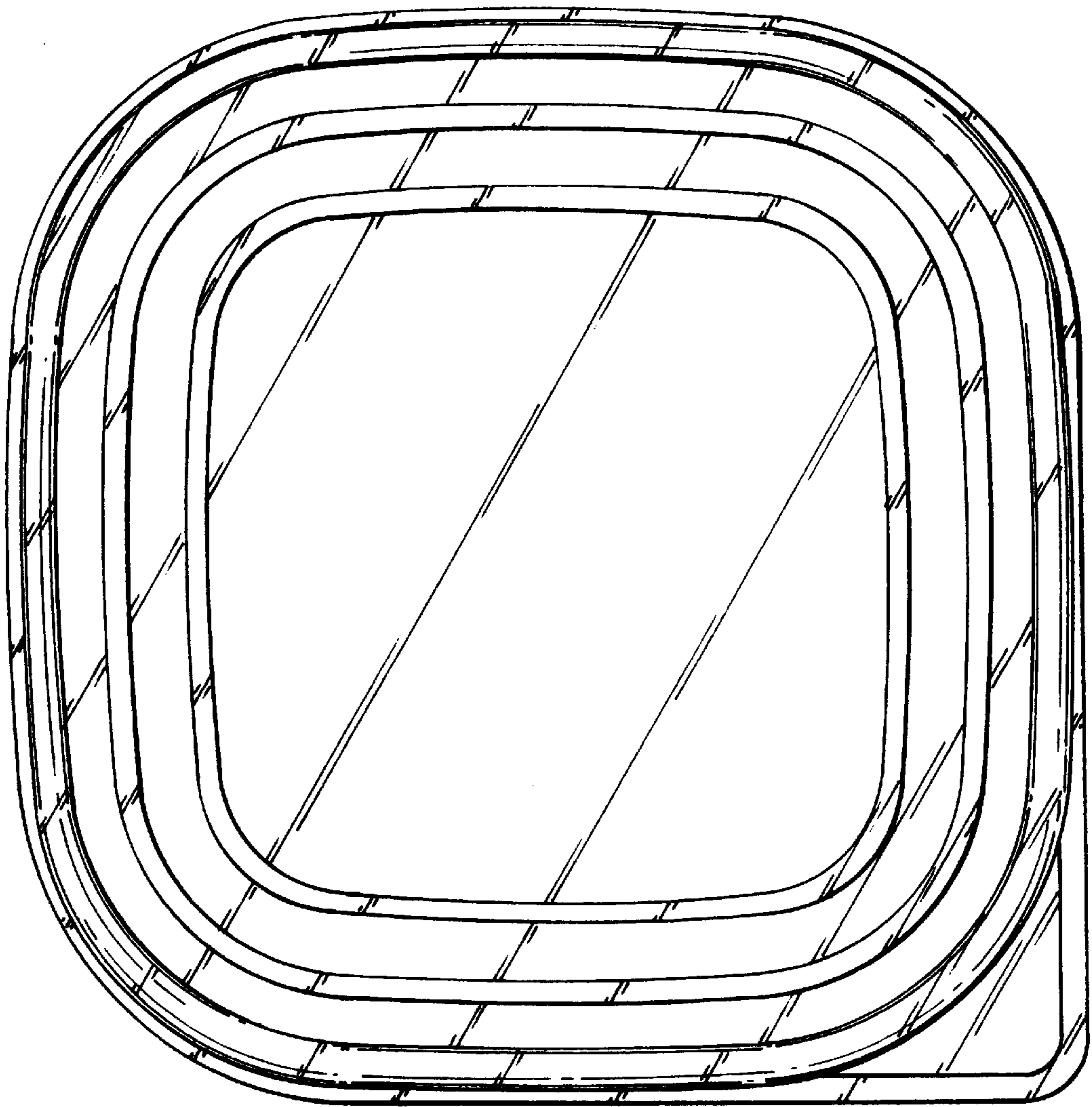


**FIG. 7**

**FIG. 8**

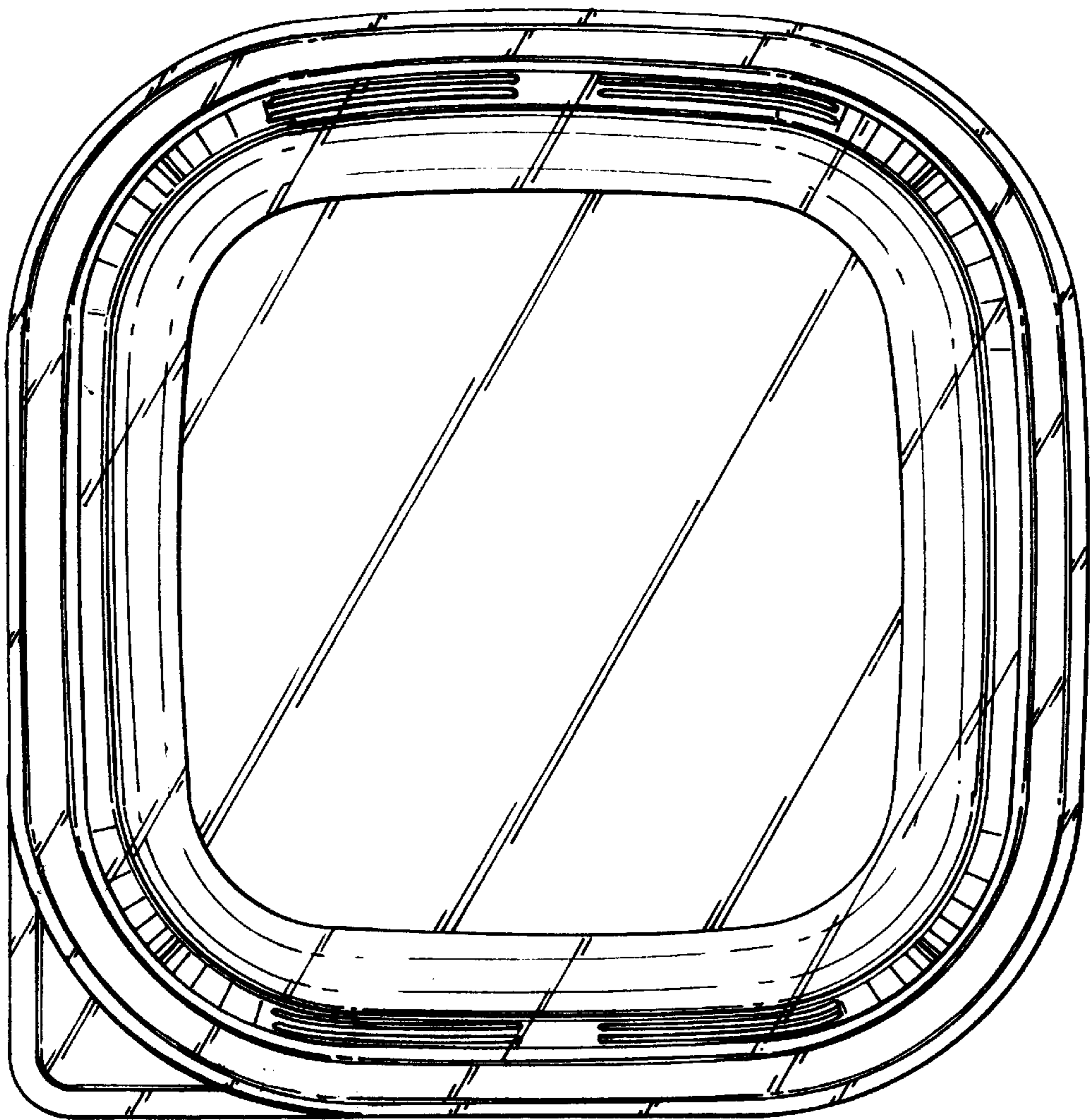
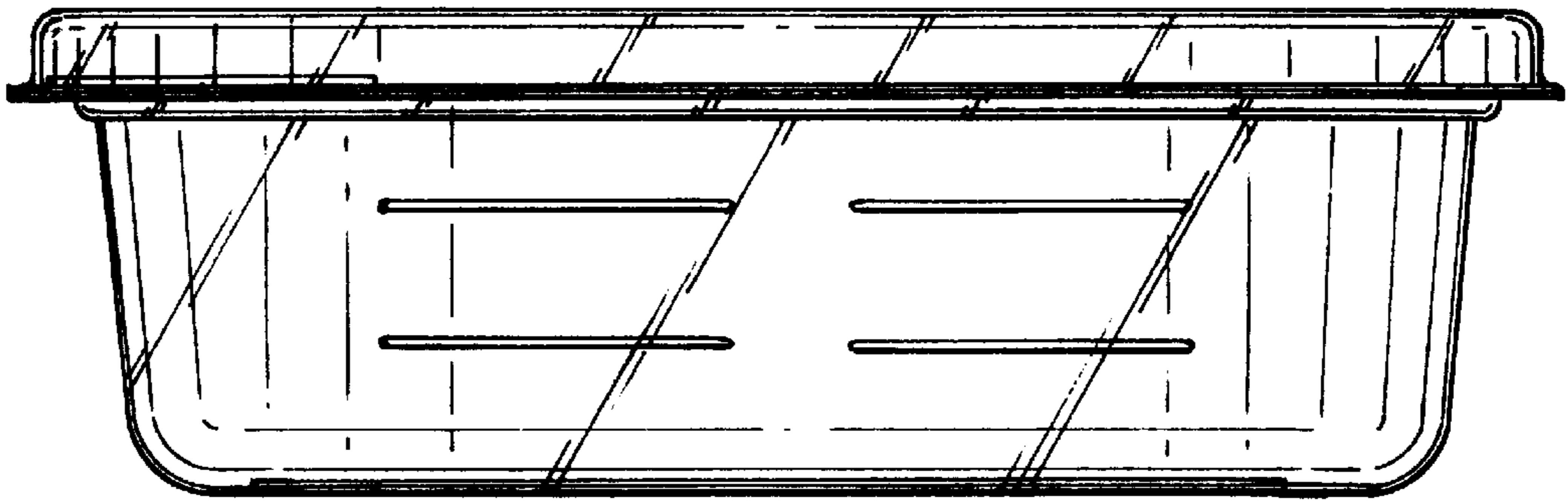


**FIG. 9**



**FIG. 10**

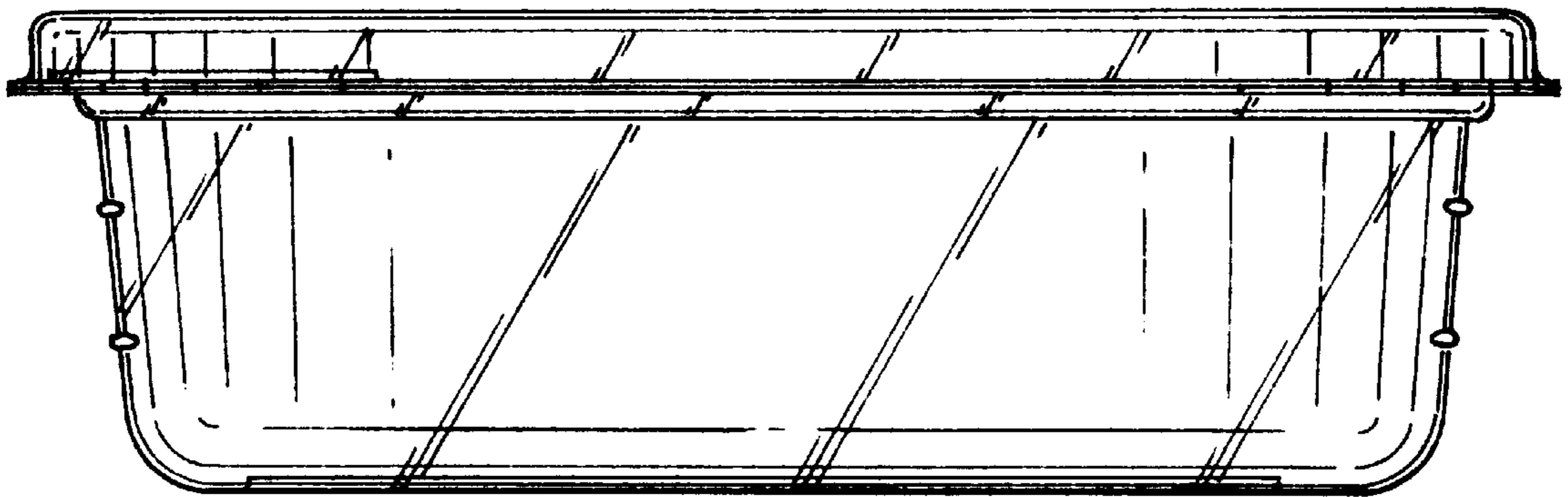
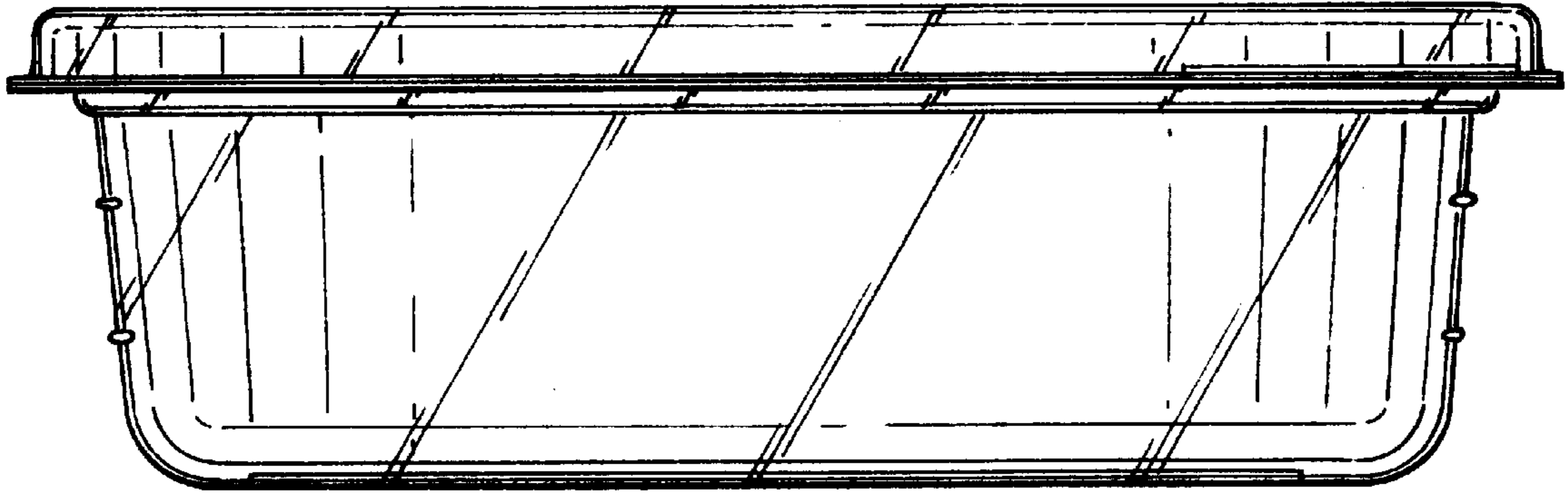
**FIG.11**



**FIG.12**



**FIG. 13**



**FIG. 14**