



US00D427048S

United States Patent [19]

Potter et al.

[11] Patent Number: **Des. 427,048**

[45] Date of Patent: **** Jun. 27, 2000**

[54] **CABLE RETAINER**

5,181,680 1/1993 Coll 248/68.1
5,827,441 10/1998 Solbjorg 248/68.1

[75] Inventors: **Victor D. Potter**, Cumming; **Joseph A. Dukes**, Dawsonville, both of Ga.

Primary Examiner—Holly Baynham
Attorney, Agent, or Firm—Mark D. Hilliard; Robert A. McCann; Michael J. Turgeon

[73] Assignee: **Panduit Corp.**, Tinley Park, Ill.

[**] Term: **14 Years**

[57] CLAIM

[21] Appl. No.: **29/106,041**

The ornamental design for a cable retainer, as shown and described.

[22] Filed: **Jun. 7, 1999**

DESCRIPTION

[51] **LOC (7) Cl.** **08-05**

FIG. 1 is a front perspective view of a cable retainer; FIG. 2 is a rear perspective view of the cable retainer of FIG. 1; FIG. 3 is a front view of the cable retainer of FIG. 1; FIG. 4 is a rear view of the cable retainer of FIG. 1; FIG. 5 is a right side view of the cable retainer of FIG. 1; FIG. 6 is a left side view of the cable retainer of FIG. 1; FIG. 7 is a top view of the cable retainer of FIG. 1; and, FIG. 8 is a bottom view of the cable retainer of FIG. 1.

[52] **U.S. Cl.** **D8/356**

[58] **Field of Search** D8/356, 380, 394-396; 248/62-65, 72, 74.1-74.4, 68.1; 174/135

[56] References Cited

U.S. PATENT DOCUMENTS

- D. 261,960 11/1981 Mathews D8/356
- D. 376,309 12/1996 Takai D8/380
- D. 394,997 6/1998 Coll D8/356

1 Claim, 2 Drawing Sheets

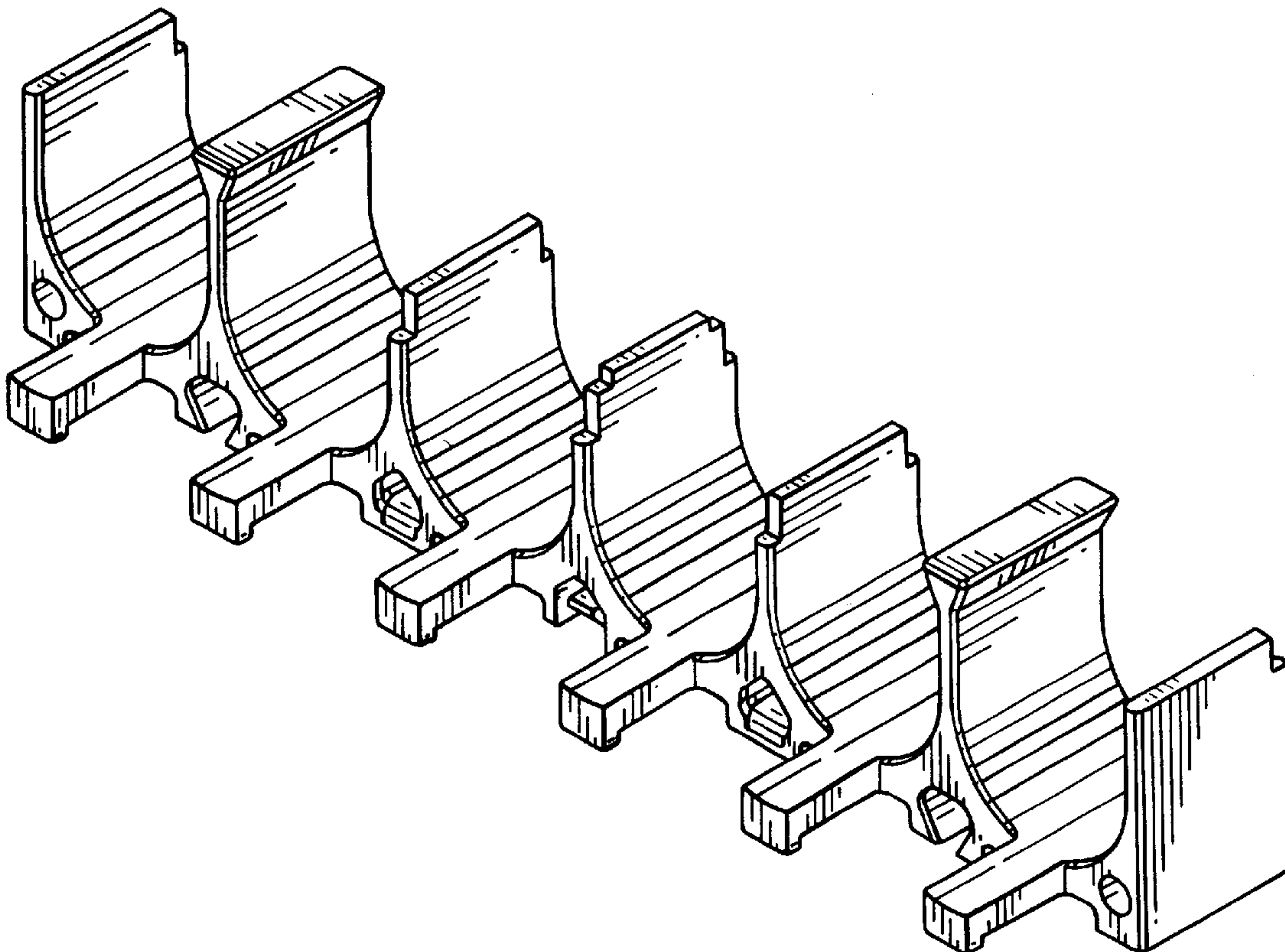

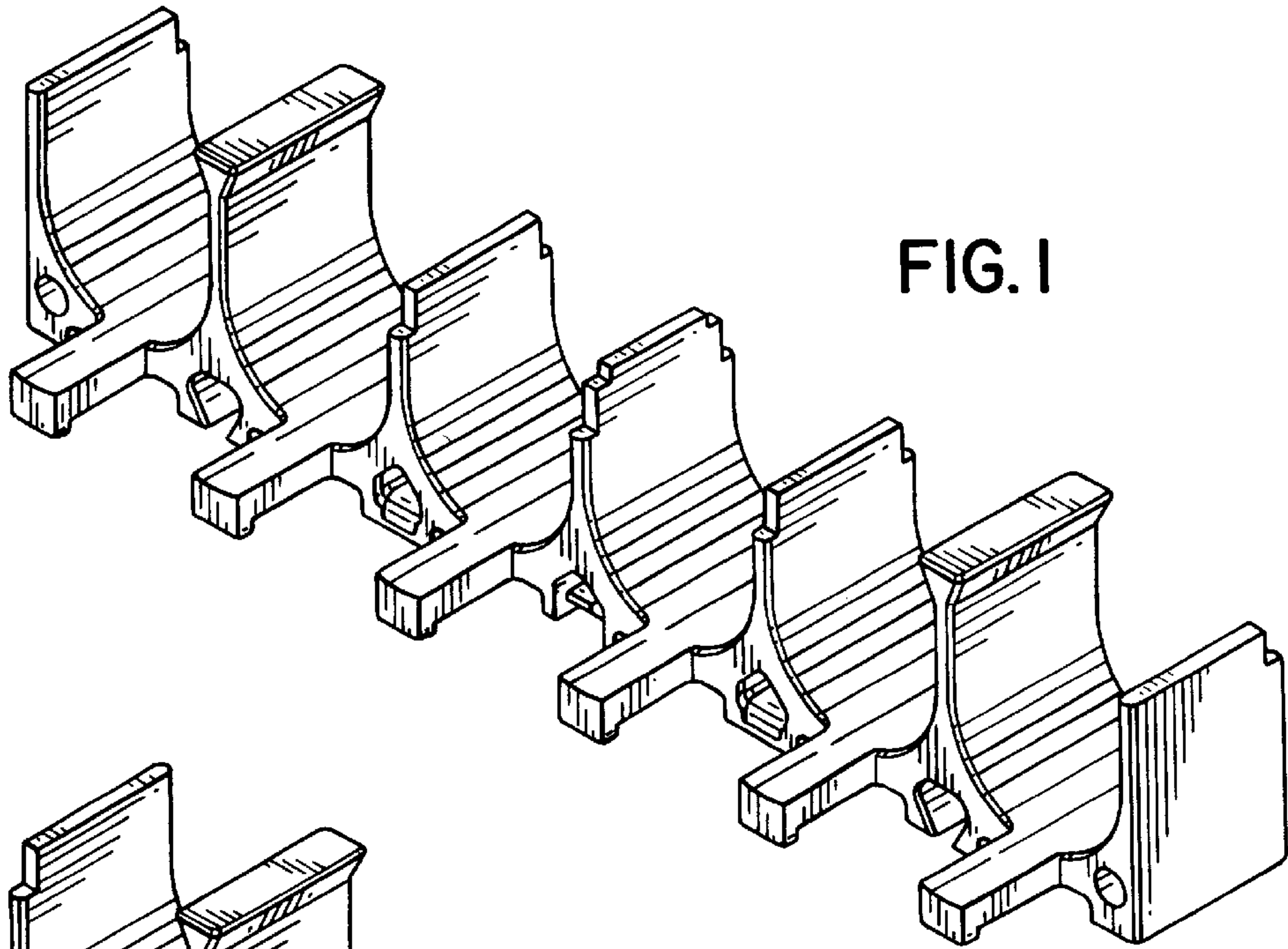

FIG. 1

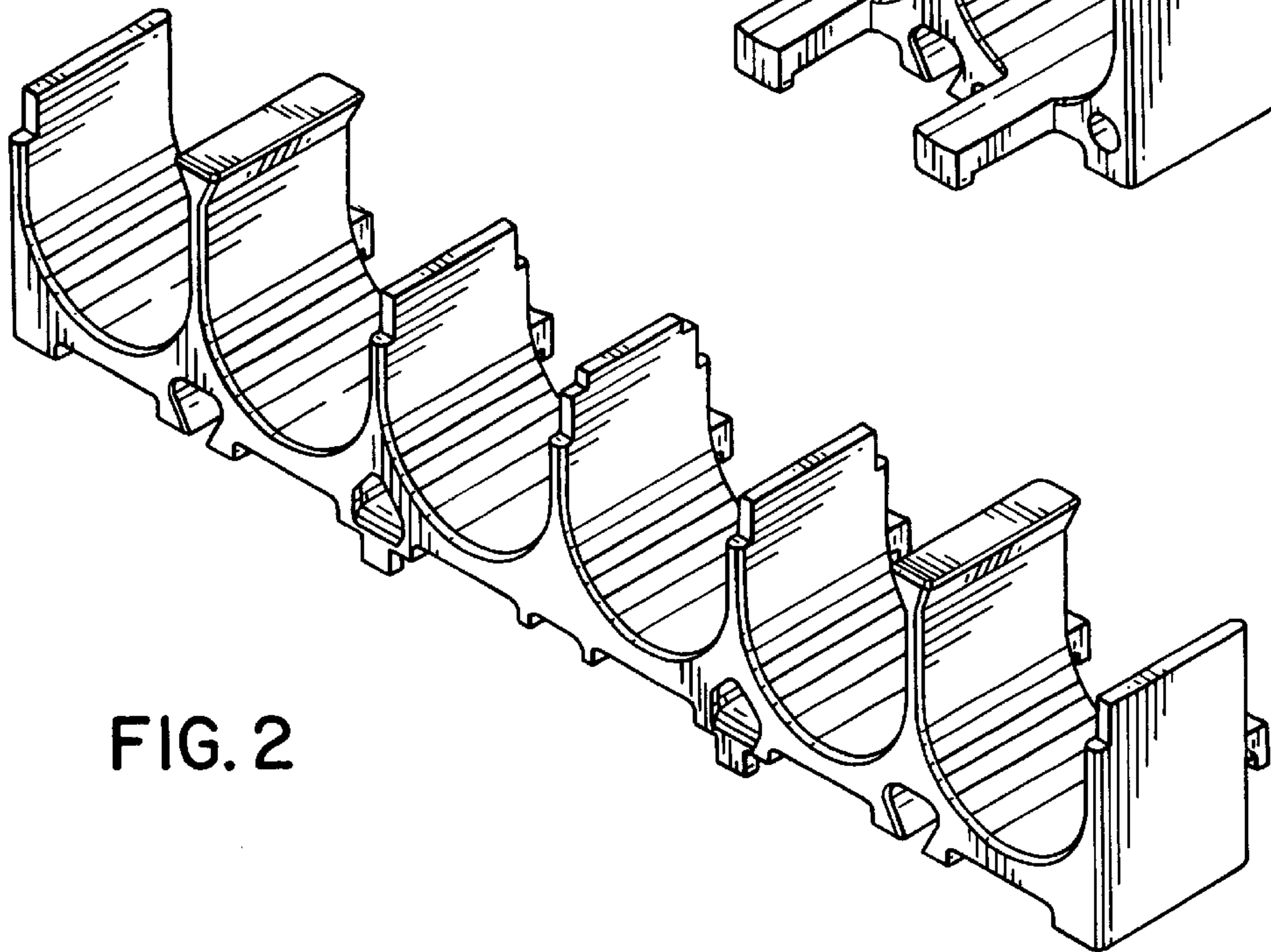

FIG. 2

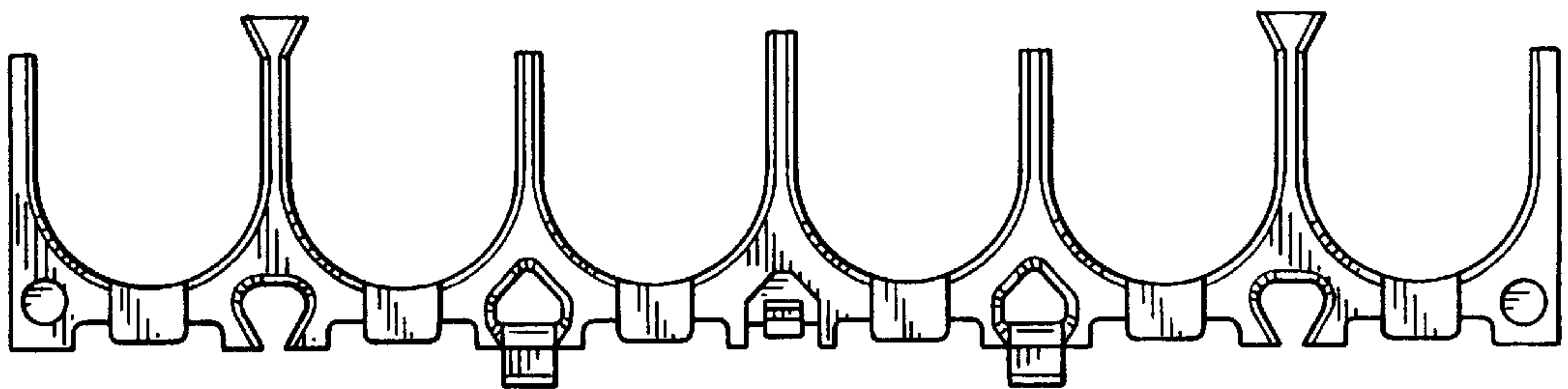

FIG. 3

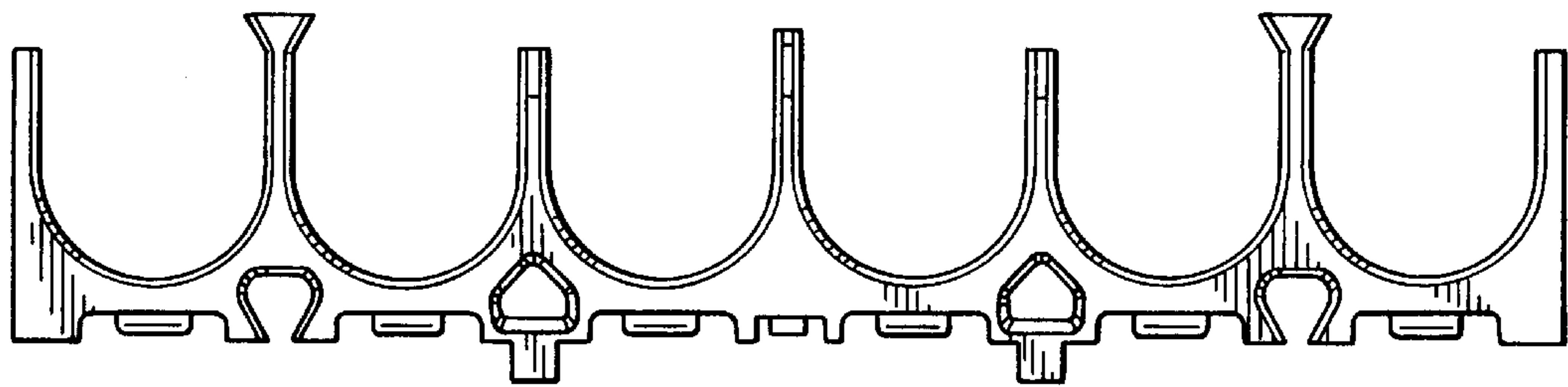

FIG. 4

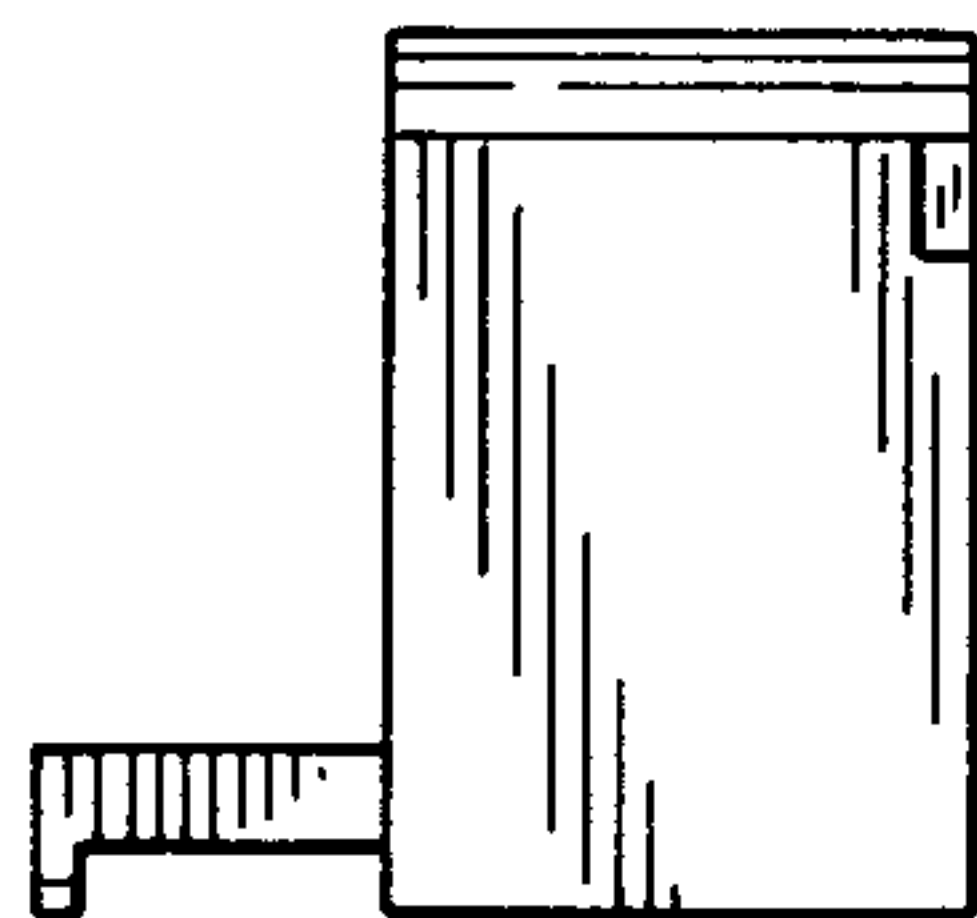

FIG. 5

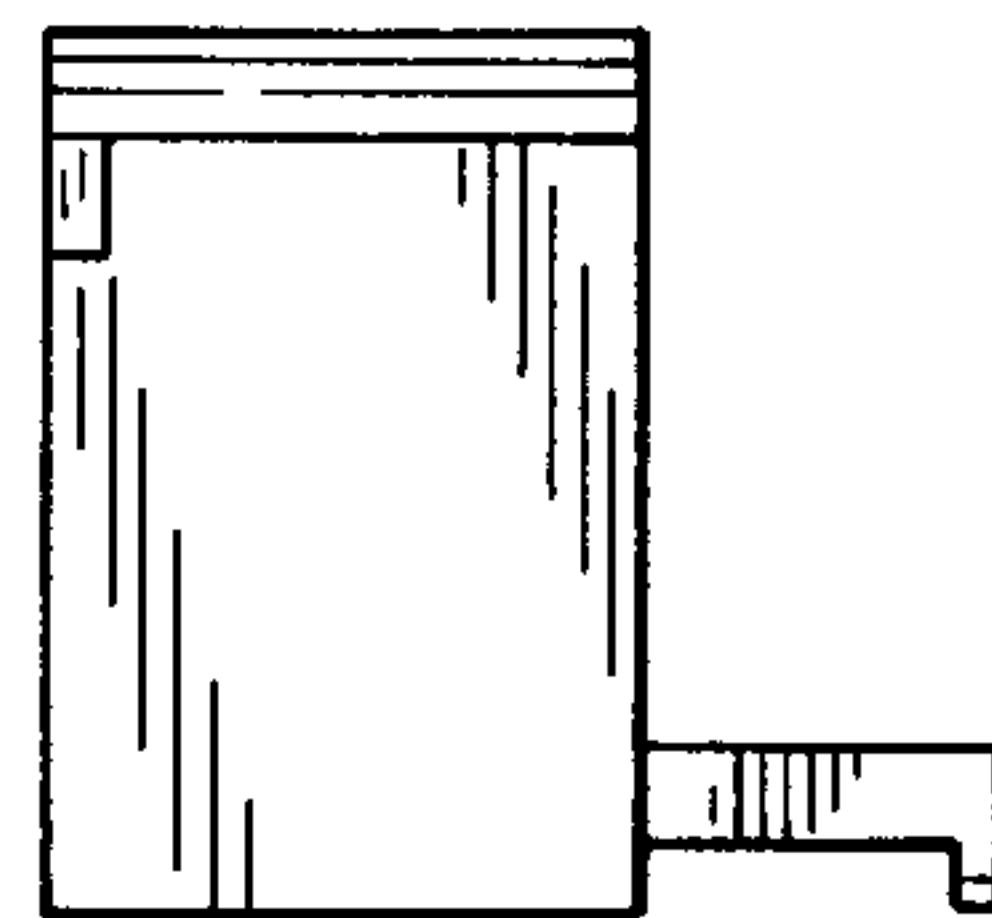

FIG. 6

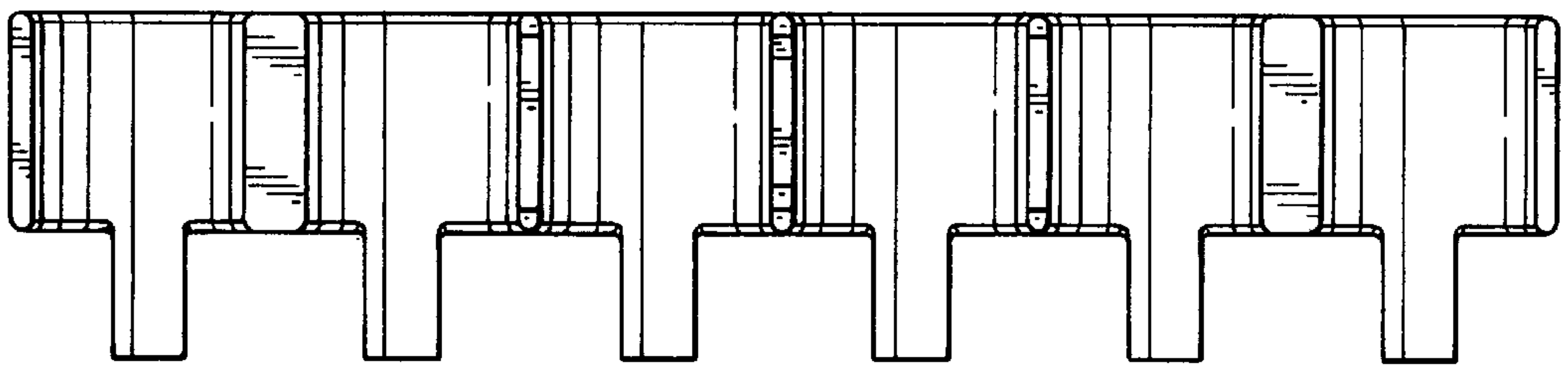

FIG. 7

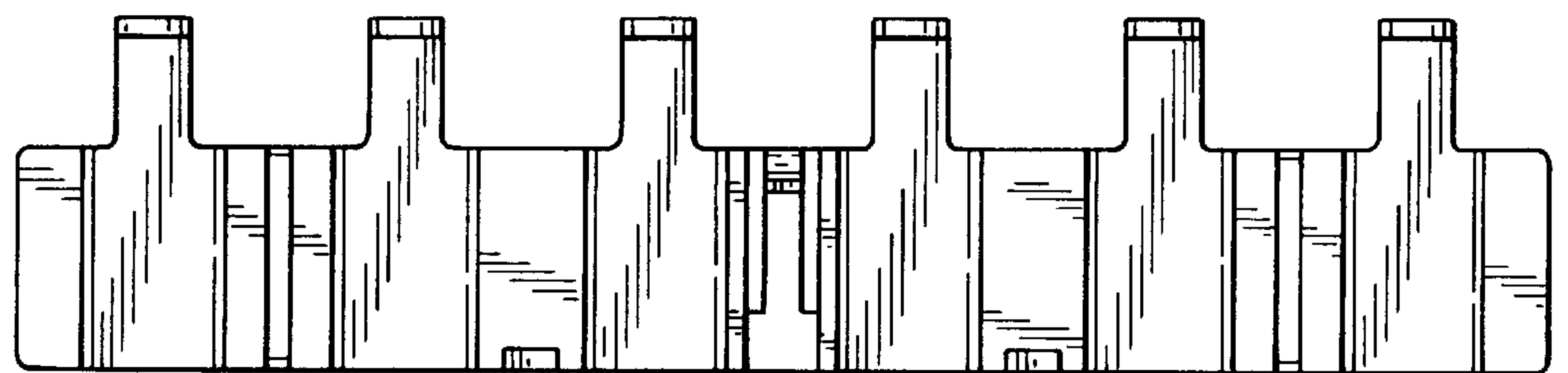

FIG. 8