



US00D426955S

**United States Patent** [19]  
**Salvatori et al.**

[11] **Patent Number: Des. 426,955**  
[45] **Date of Patent: \*\* Jun. 27, 2000**

[54] **CARRYING CASE**

**DESCRIPTION**

[75] Inventors: **Phillip H. Salvatori**, Salem; **Martin John Maiers**, Newberg; **Stephen V. Cooper**, Amity; **Jonathan Neal Andrews**, McMinnville, all of Oreg.  
[73] Assignee: **Hewlett-Packard Company**, Palo Alto, Calif.  
[\*\*] Term: **14 Years**  
[21] Appl. No.: **29/101,196**  
[22] Filed: **Feb. 26, 1999**  
[51] **LOC (7) Cl.** ..... **03-01**  
[52] **U.S. Cl.** ..... **D3/301; D3/289; D3/273**  
[58] **Field of Search** ..... **D3/273, 272, 274, D3/276, 285, 287, 288, 289, 290; D24/167, 168; 607/4, 5; 206/320, 570; 190/100, 112**

[56] **References Cited**

**U.S. PATENT DOCUMENTS**

D. 305,796	1/1990	Forland et al.	.....	D24/167
D. 333,703	3/1993	Stepler	.....	D24/167
D. 338,104	8/1993	Lee	.....	D3/287
D. 358,483	5/1995	Cross et al.	.....	D3/289
D. 360,075	7/1995	Cross et al.	.....	D3/289
D. 377,097	12/1996	Olson et al.	.....	D24/168
D. 380,612	7/1997	Kelley et al.	.....	D3/289
D. 392,739	3/1998	Bertagnole et al.	.....	D24/167
D. 405,957	2/1999	Test	.....	D3/289
5,464,428	11/1995	Hill	.....	607/1
5,574,252	11/1996	Hill	.....	174/51
5,938,096	8/1999	Sauer et al.	.....	206/320

*Primary Examiner*—Philip S. Hyder

[57] **CLAIM**

The ornamental design for a carrying case, as shown and described.

FIG. 1 is a perspective view of a carrying case, showing my new design, wherein the flap is shown in its unzipped open position;  
FIG. 2 is a perspective view of the carrying case illustrated in FIG. 1, with the zippered flap in its closed position;  
FIG. 3 is a front view of the carrying case illustrated in FIG. 2;  
FIG. 4 is a back view of the carrying case illustrated in FIG. 2;  
FIG. 5 is a right view of the carrying case illustrated in FIG. 2;  
FIG. 6 is a left view of the carrying case illustrated in FIG. 2;  
FIG. 7 is a top view of the carrying case illustrated in FIG. 2;  
FIG. 8 is a bottom view of the carrying case illustrated in FIG. 2;  
FIG. 9 is a perspective view of an alternate embodiment of the carrying case, wherein the flap is shown in its unzipped open position;  
FIG. 10 is a perspective view of the carrying case illustrated in FIG. 9, wherein the zippered flap is in its closed position;  
FIG. 11 is a front view of the carrying case illustrated in FIG. 10;  
FIG. 12 is a back view of the carrying case illustrated in FIG. 10;  
FIG. 13 is a right view of the carrying case illustrated in FIG. 10;  
FIG. 14 is a left view of the carrying case illustrated in FIG. 10;  
FIG. 15 is a top view of the carrying case illustrated in FIG. 10; and,  
FIG. 16 is a bottom view of the carrying case illustrated in FIG. 10.

The broken line showings of the defibrillator and the other structure are for illustrative purposes only and form no part of the claimed design.

**1 Claim, 6 Drawing Sheets**

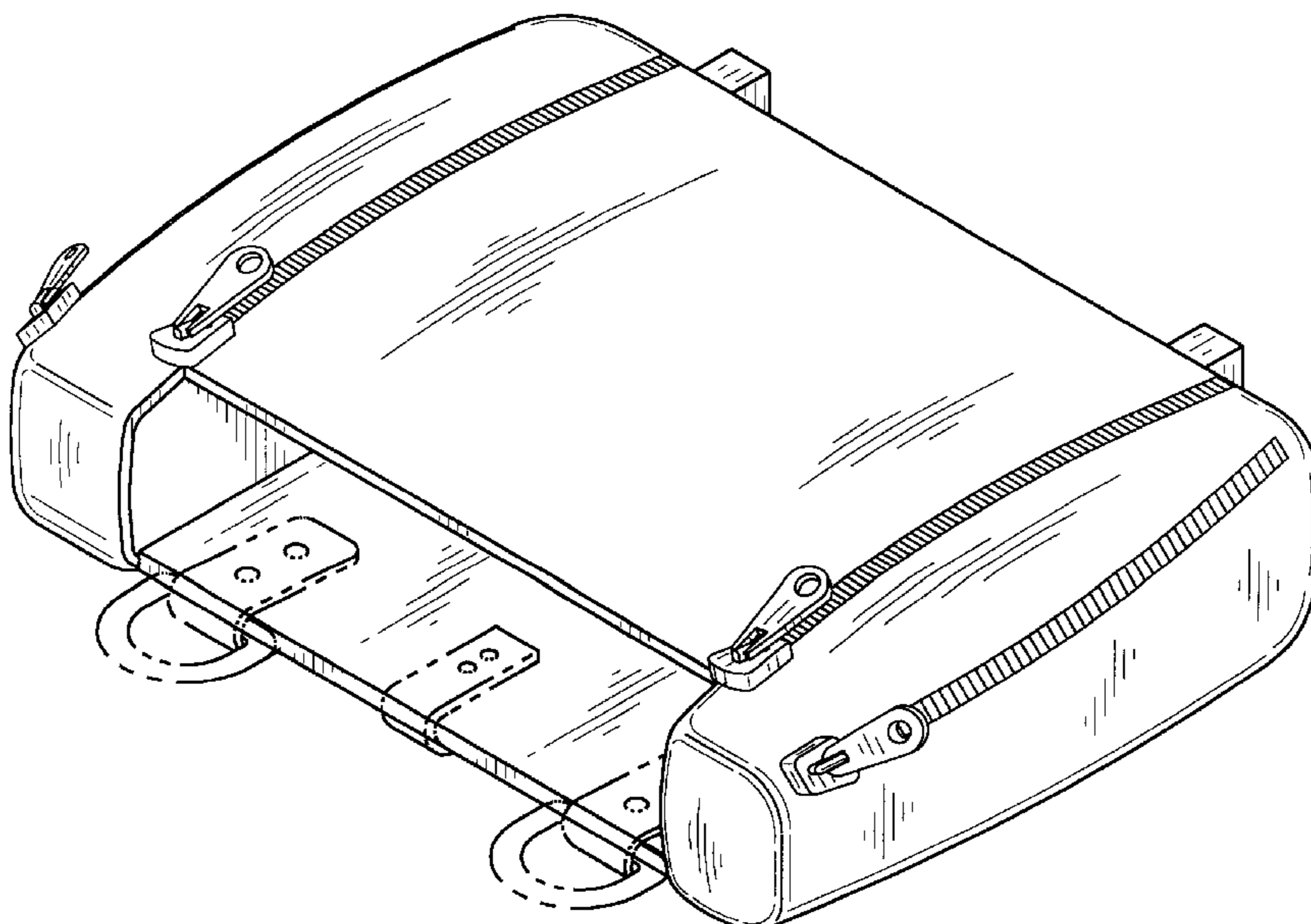

FIG. 1

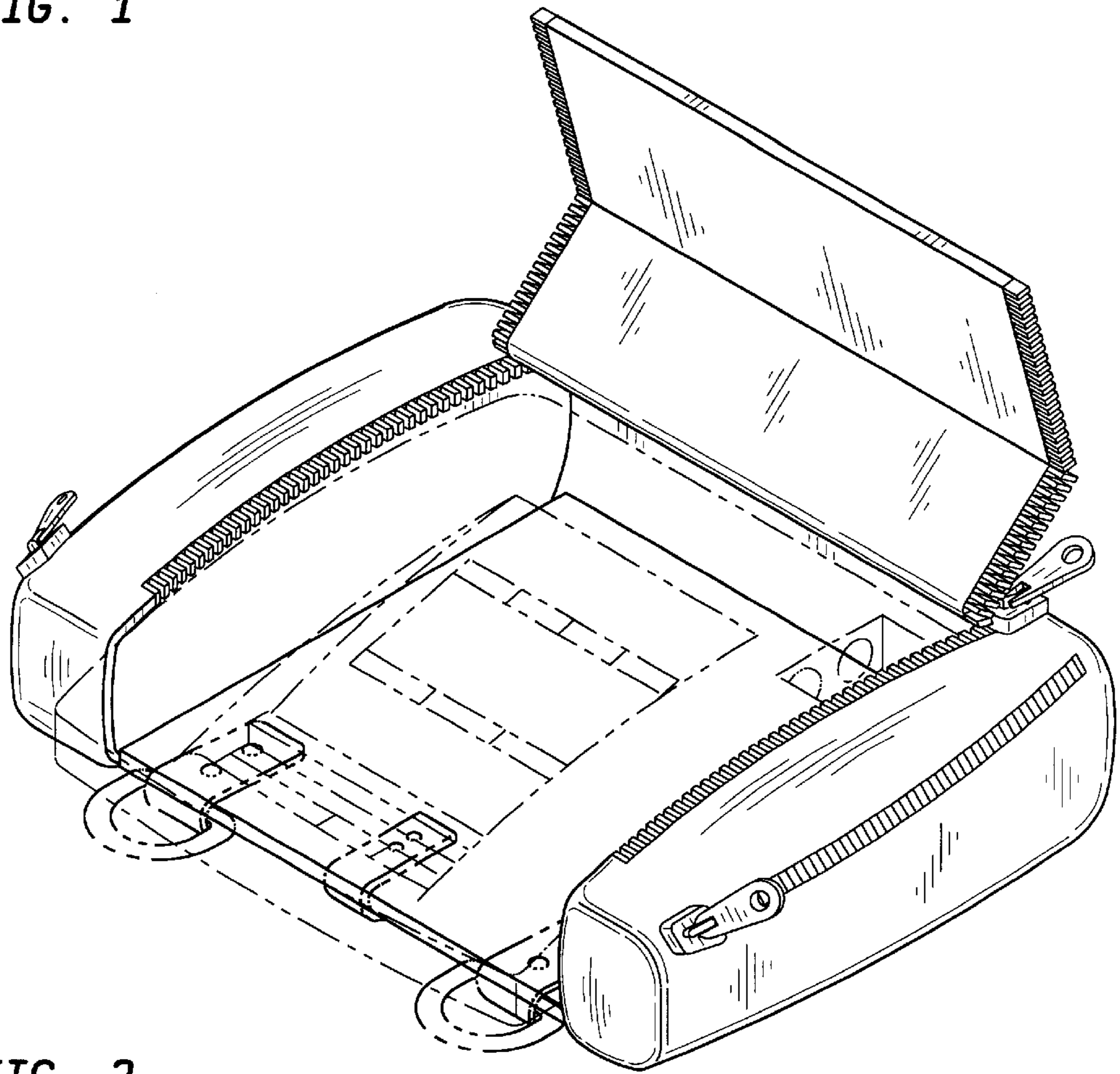
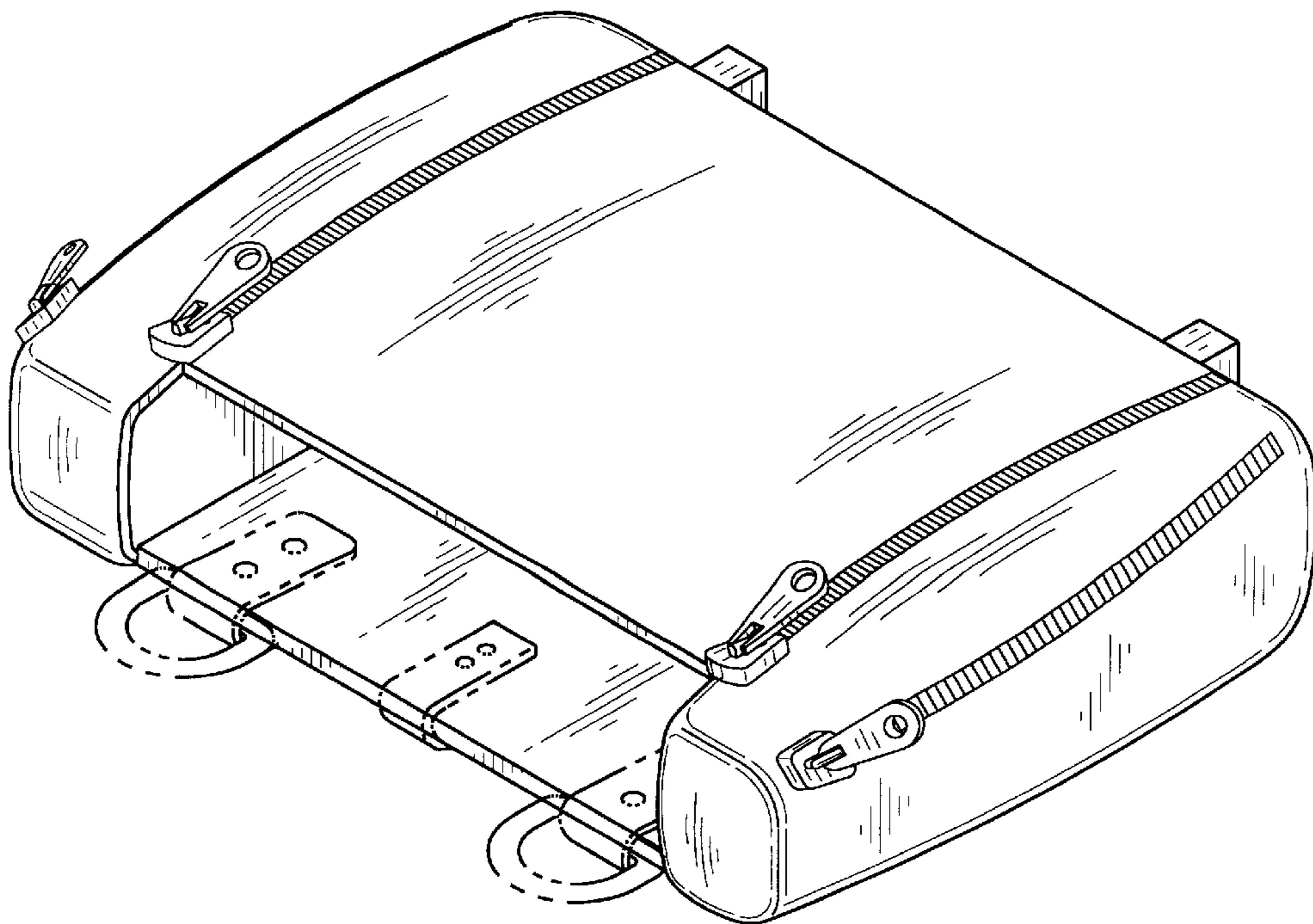
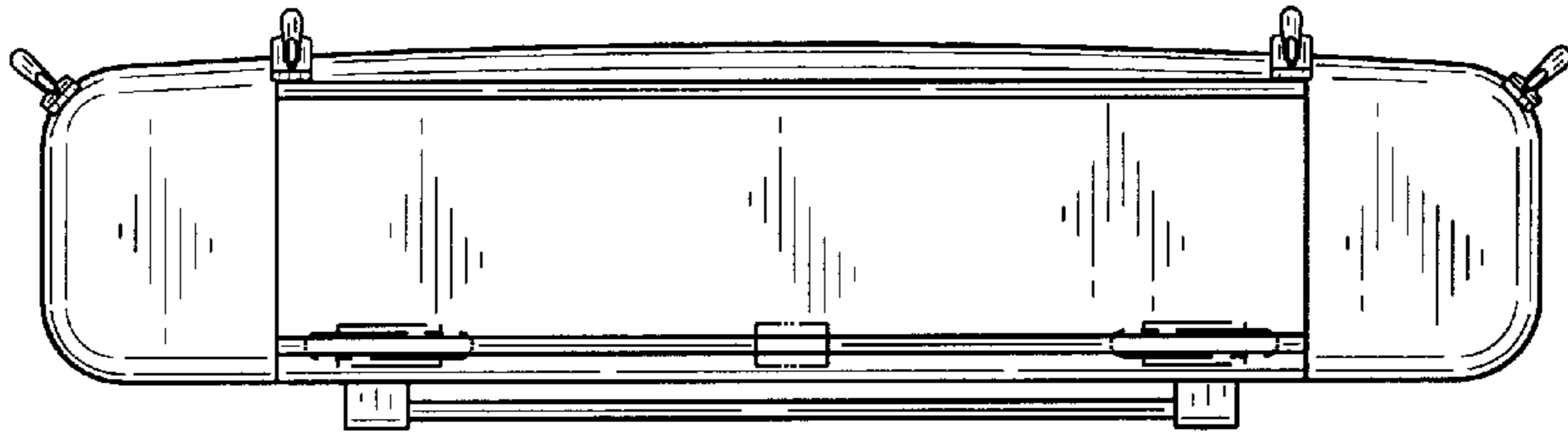

FIG. 2



**FIG. 3**



**FIG. 4**

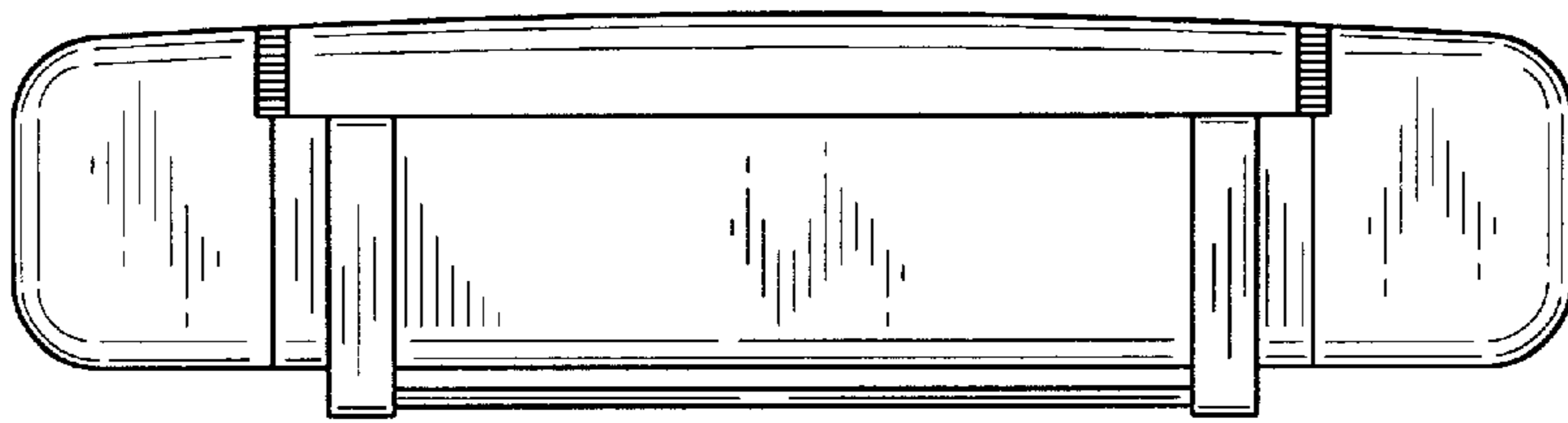

**FIG. 5**

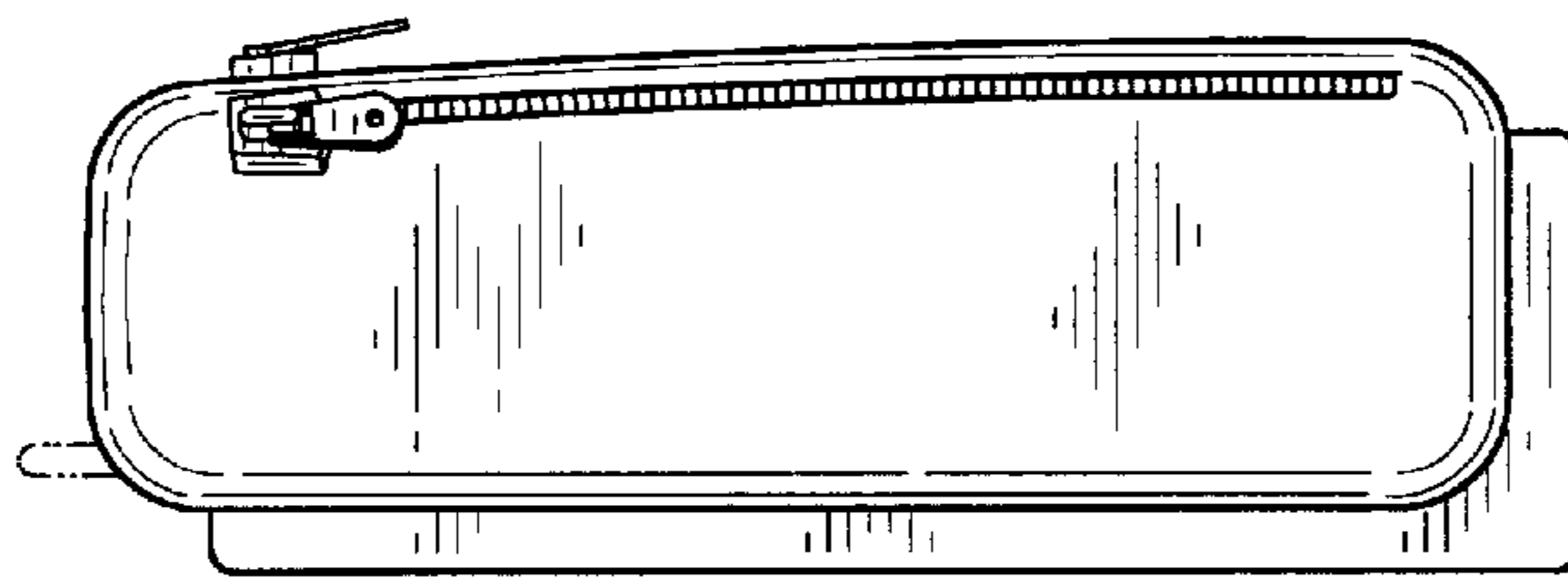

**FIG. 6**

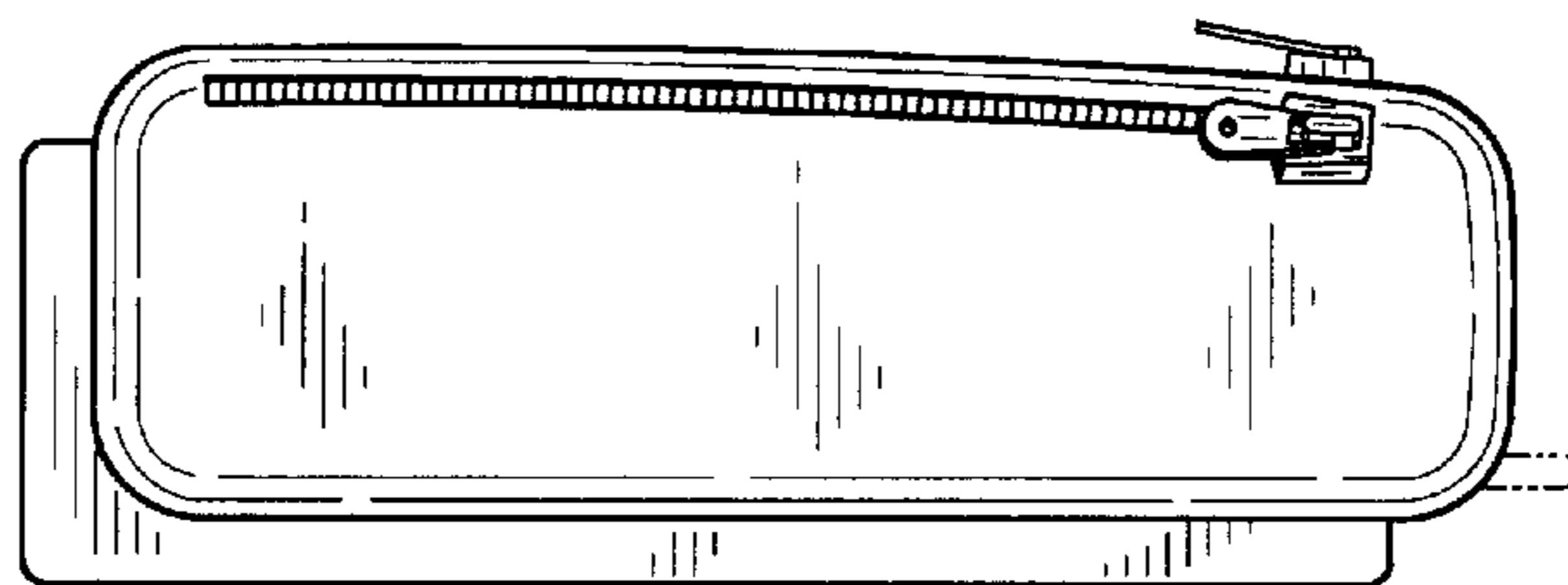

FIG. 7

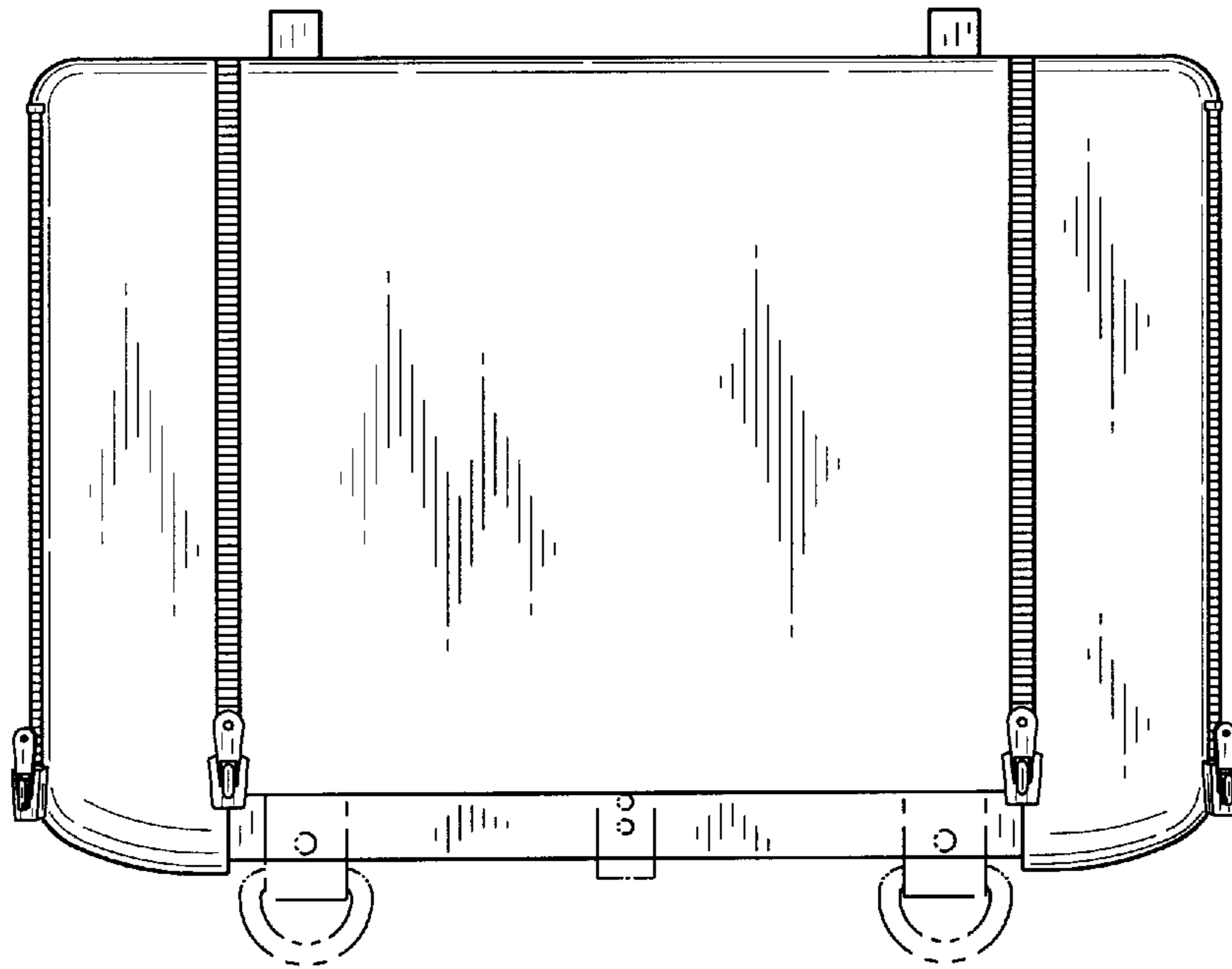

FIG. 8

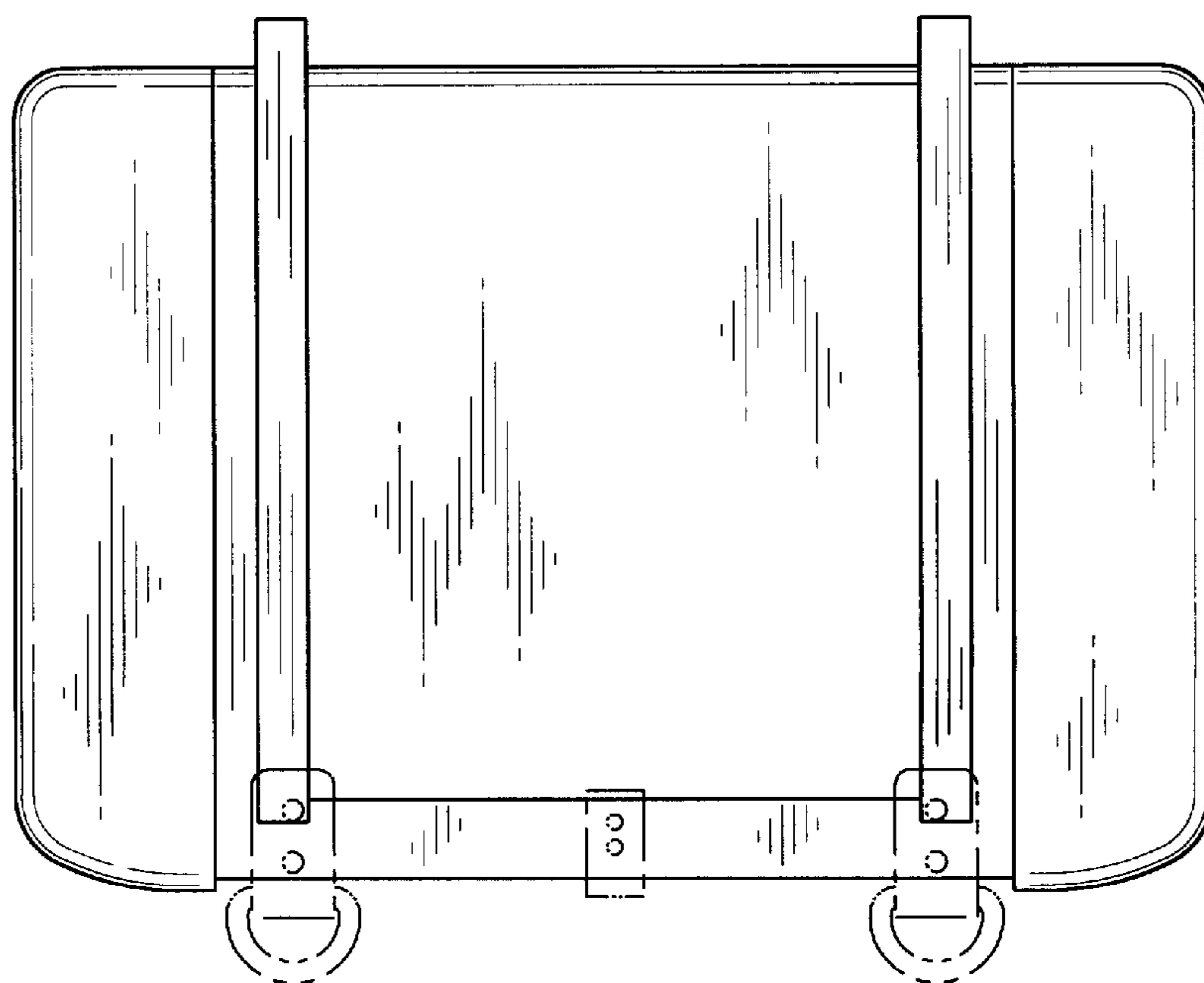

FIG. 9

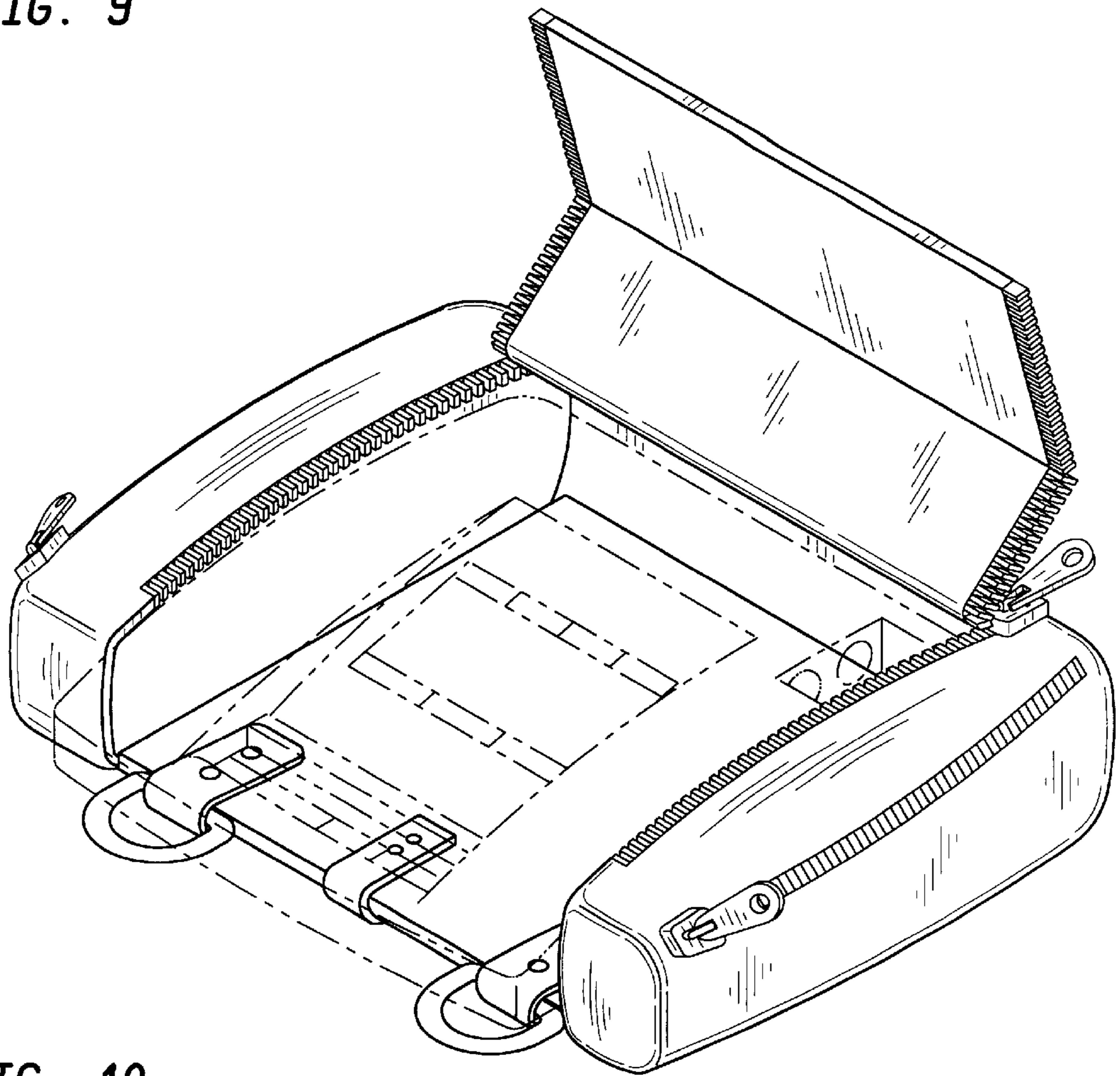
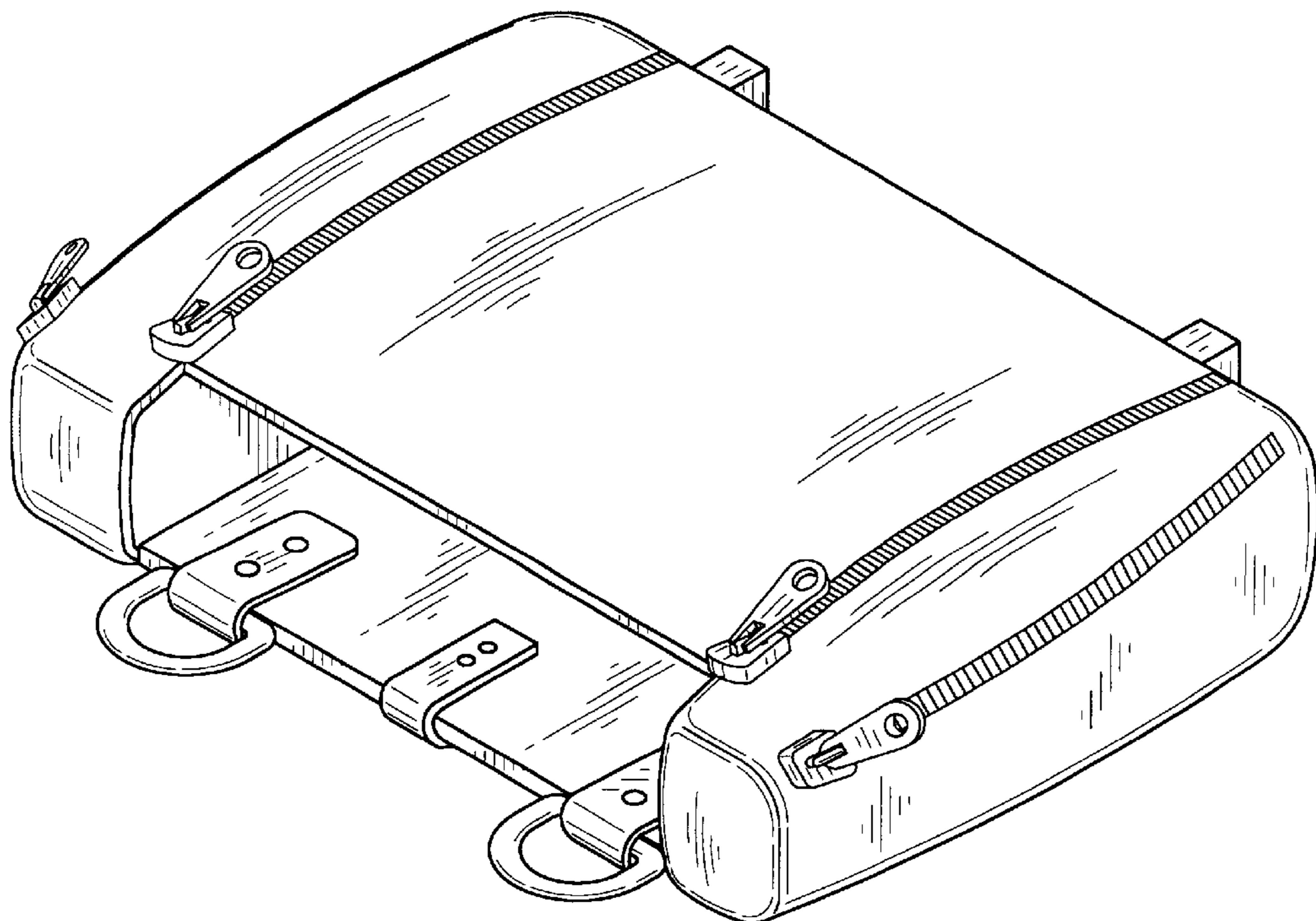
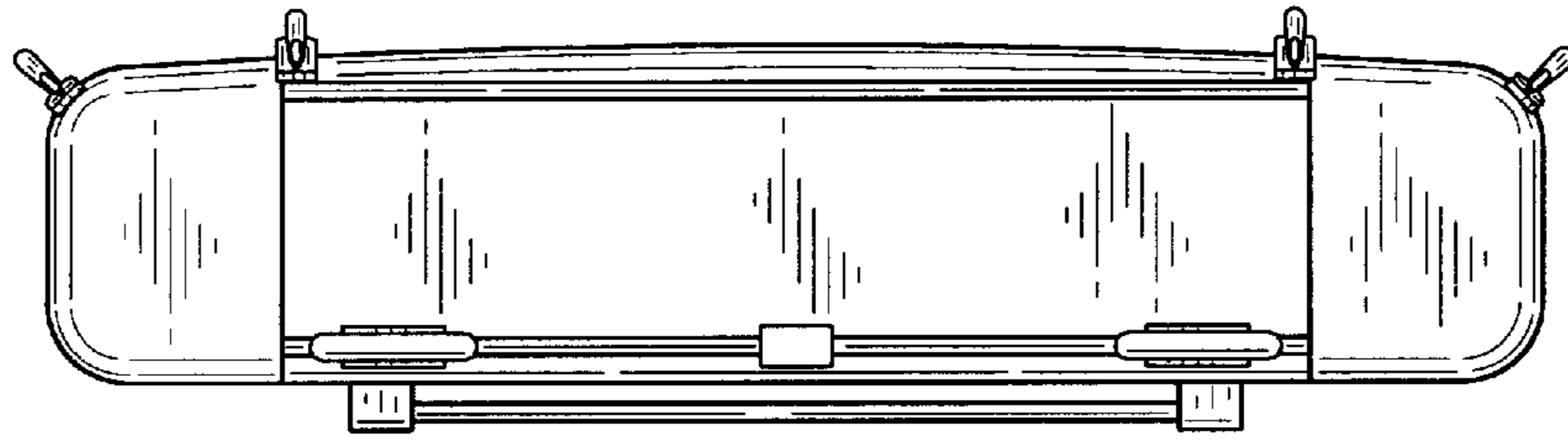

FIG. 10



**FIG. 11**



**FIG. 12**

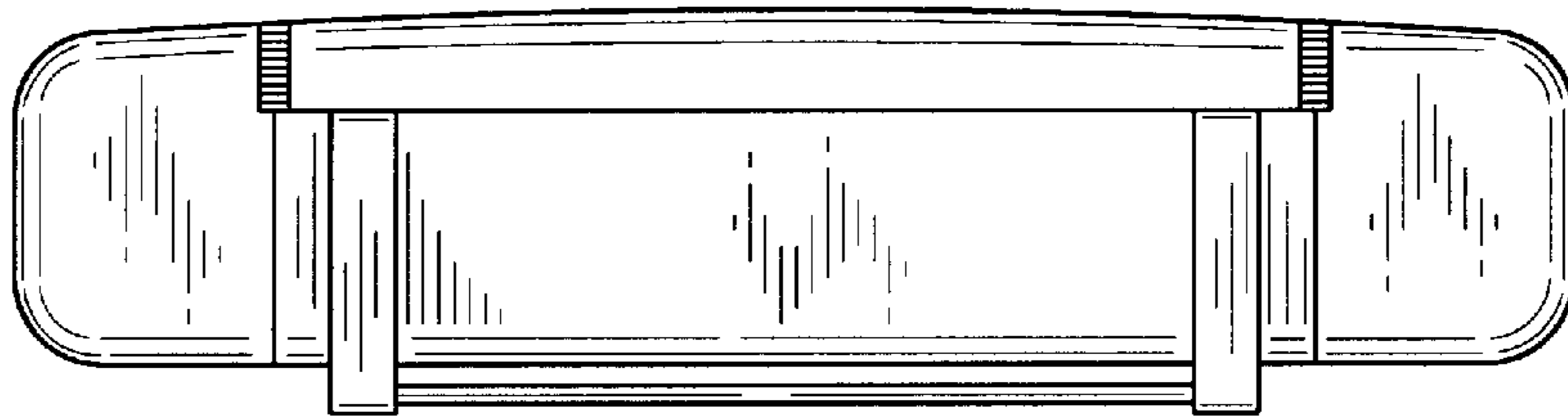

**FIG. 13**

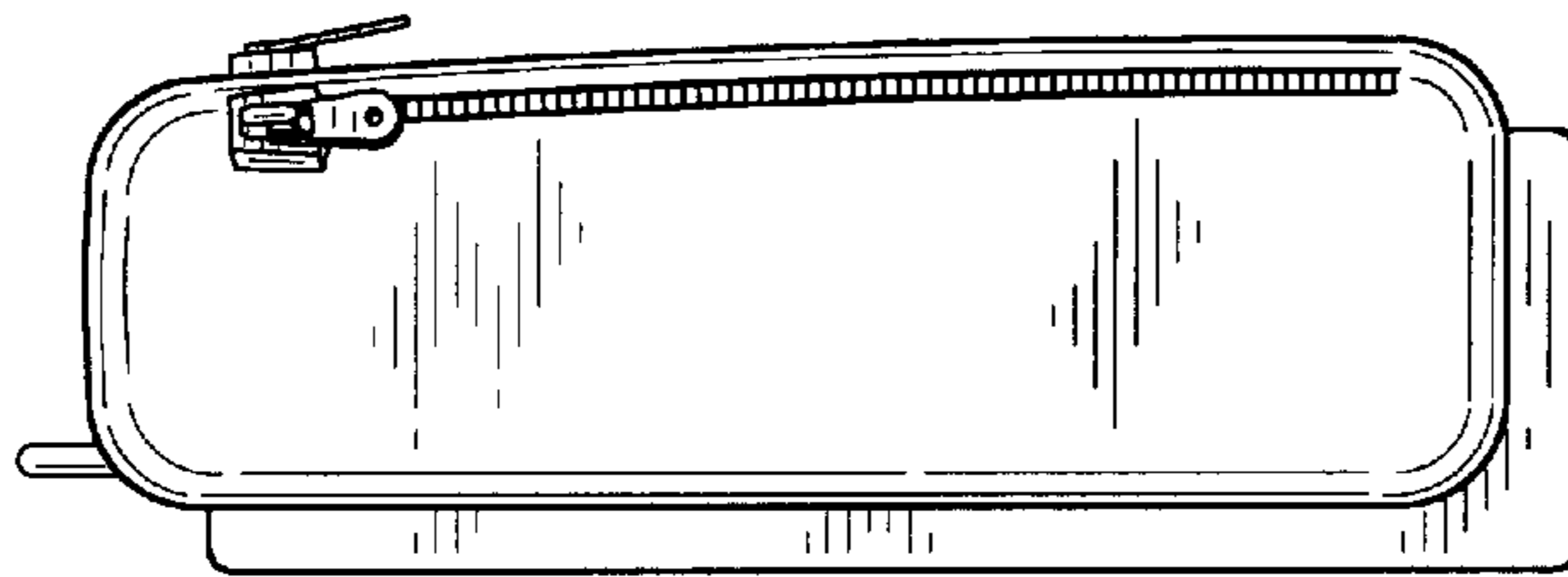

**FIG. 14**

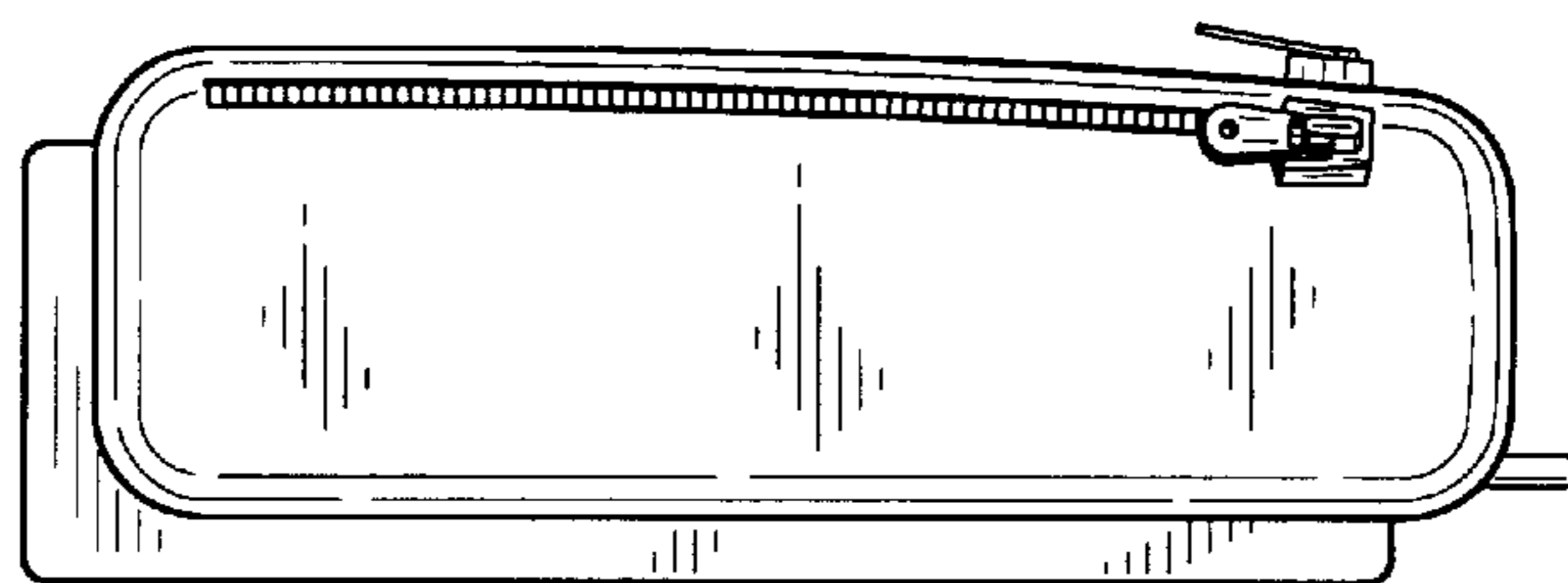

FIG. 15

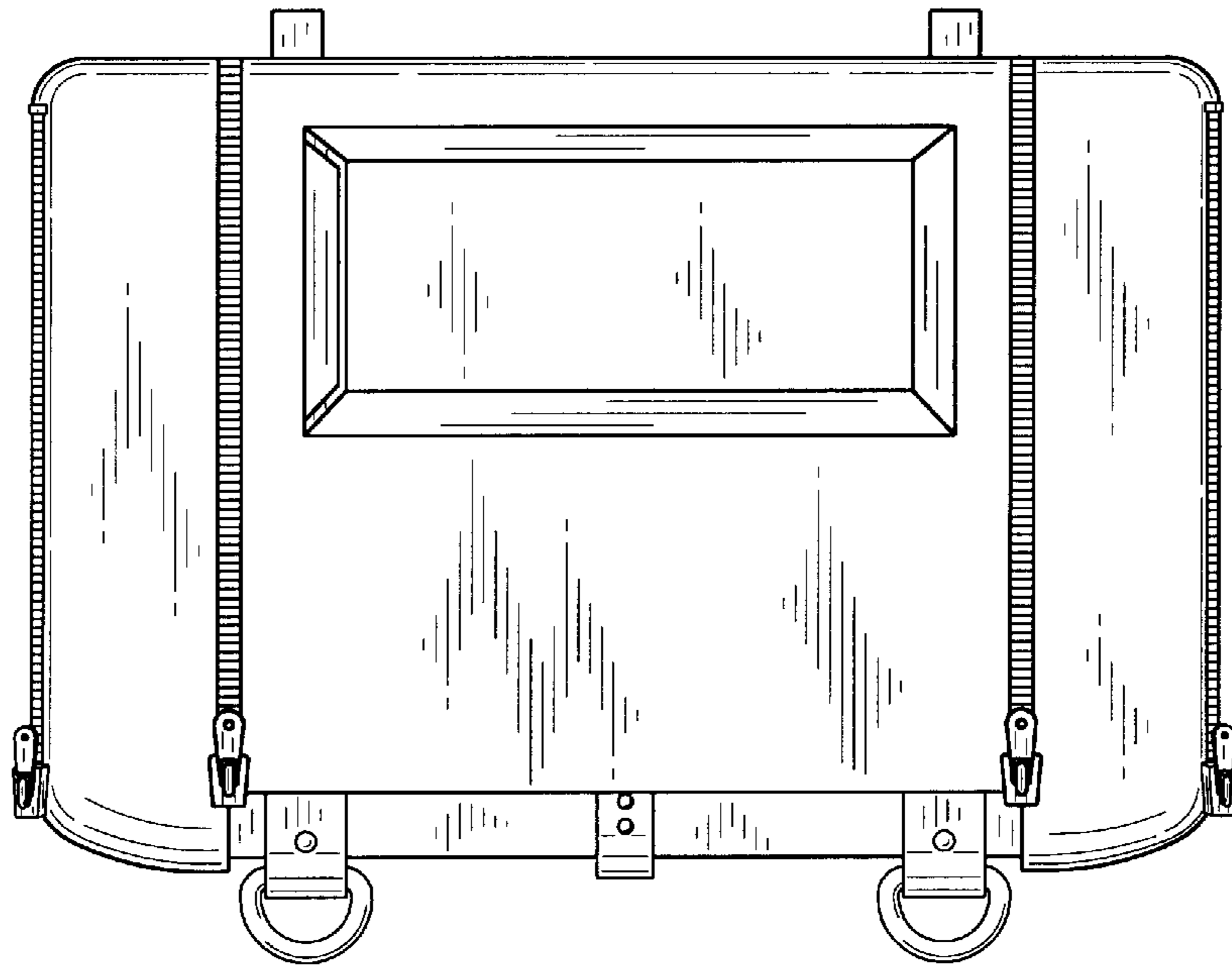

FIG. 16

