



US00D426829S

# United States Patent [19] Curtis

[11] **Patent Number: Des. 426,829**

[45] **Date of Patent: \*\* Jun. 20, 2000**

[54] **LENS FOR A TELEPHONE HANDSET**

[75] Inventor: **Alastair Curtis**, Woodland Hills, Calif.

[73] Assignee: **Nokia Mobile Phones, Ltd.**, Espoo, Finland

[\*\*] Term: **14 Years**

[21] Appl. No.: **29/109,149**

[22] Filed: **Aug. 9, 1999**

[51] **LOC (7) Cl.** ..... **14-03**

[52] **U.S. Cl.** ..... **D14/248**

[58] **Field of Search** ..... D14/137, 138,  
D14/147-148, 247-248, 250, 240, 140-142;  
379/433.434, 368, 419, 420, 428, 440;  
455/550-575, 90

[56] **References Cited**

**U.S. PATENT DOCUMENTS**

D. 388,784	1/1998	Phillips et al.	.....	D14/138
D. 393,470	4/1998	Nagele et al.	.....	D14/249
D. 405,783	2/1999	Nuovo et al.	.....	D14/138
D. 405,784	2/1999	Phillips et al.	.....	D14/138
D. 405,785	2/1999	Vuolteenaho	.....	D14/138

D. 409,598	5/1999	Tattari	.....	D14/138
D. 409,599	5/1999	Tattari	.....	D14/138
D. 409,999	5/1999	Nuovo et al.	.....	D14/138
D. 415,149	10/1999	Vuolteenaho et al.	.....	D14/138
D. 415,770	10/1999	Nuovo	.....	D14/248
5,745,566	4/1998	Petrella et al.	.....	379/433
5,768,370	6/1998	Maatta et al.	.....	379/433

*Primary Examiner*—Jeffrey Asch  
*Attorney, Agent, or Firm*—Perman & Green, LLP

[57] **CLAIM**

The ornamental design for a “lens for a telephone handset”, as shown and described.

**DESCRIPTION**

FIG. 1 is a front, bottom and right side perspective view of a lens for a telephone handset showing my new design; FIG. 2 is a rear, top, and right side perspective view thereof; FIG. 3 is a left side view thereof; FIG. 4 is a bottom plan view thereof; FIG. 5 is a front elevational view thereof; FIG. 6 is a top plan view thereof; FIG. 7 is a right side view thereof; and, FIG. 8 is a rear elevational view thereof.

**1 Claim, 3 Drawing Sheets**

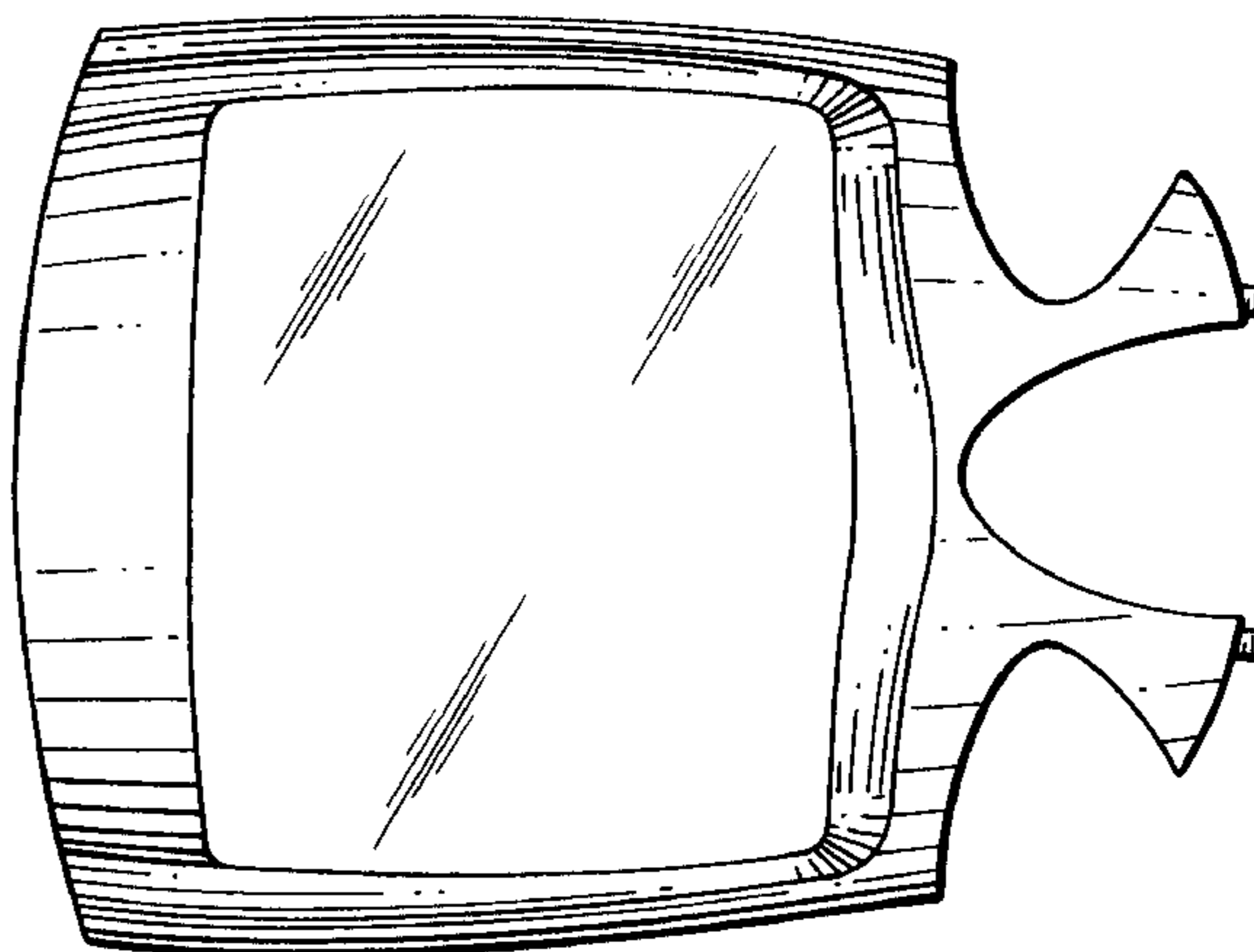
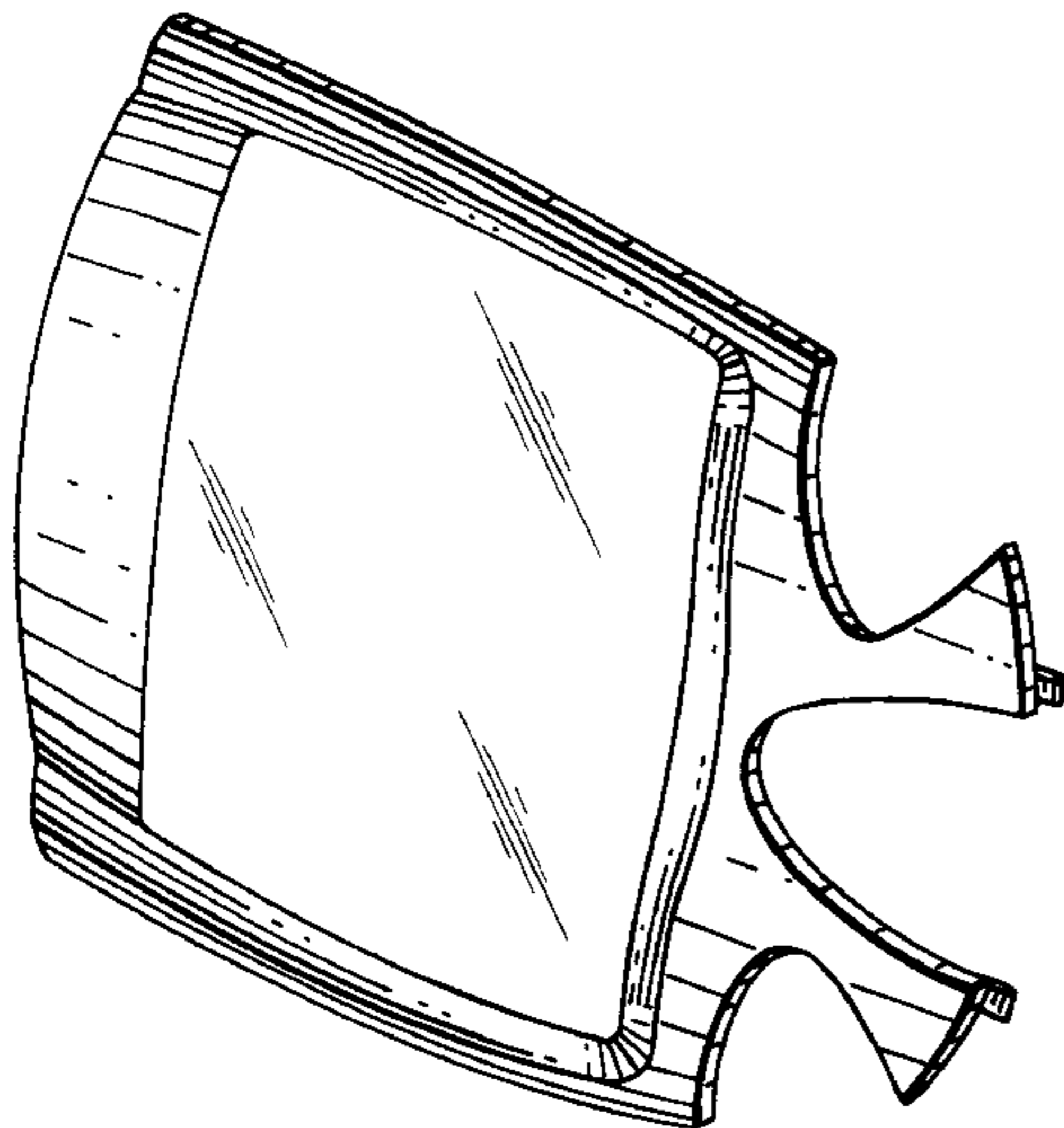

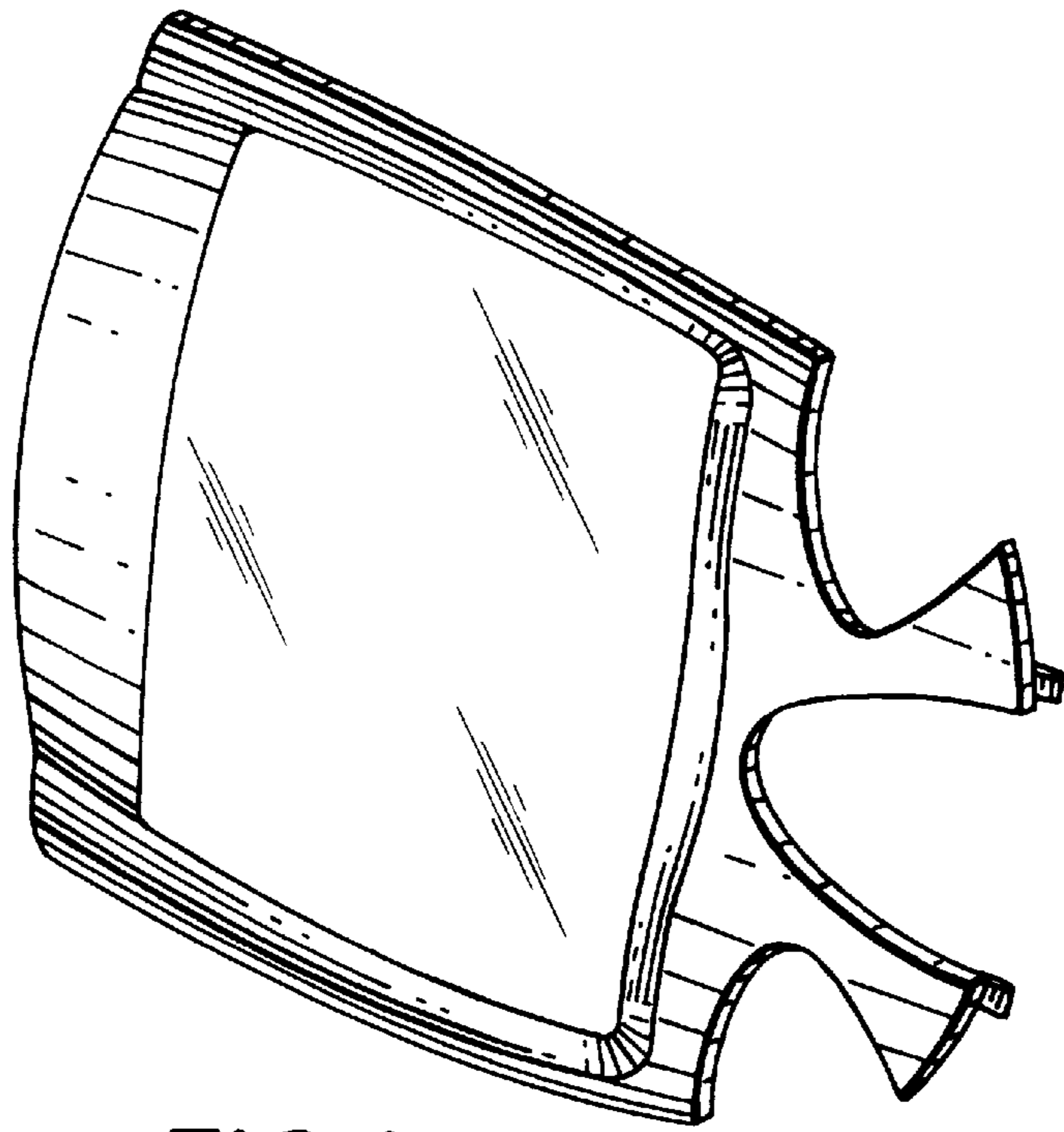

FIG. 1

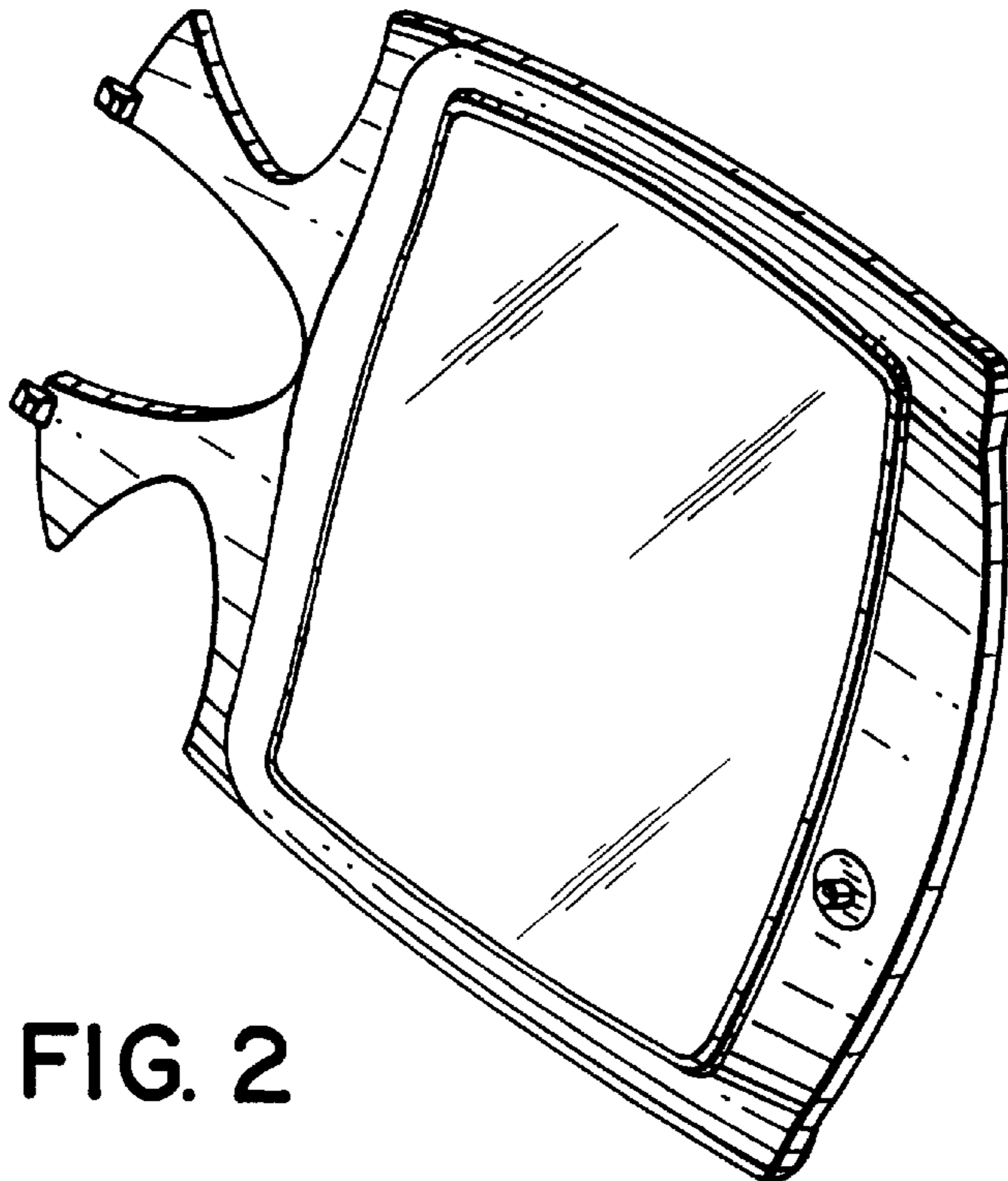

FIG. 2

FIG. 3

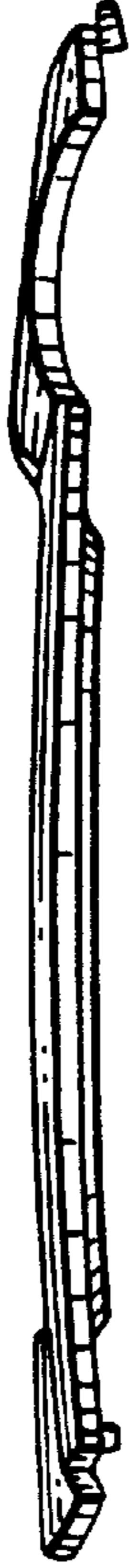

FIG. 5

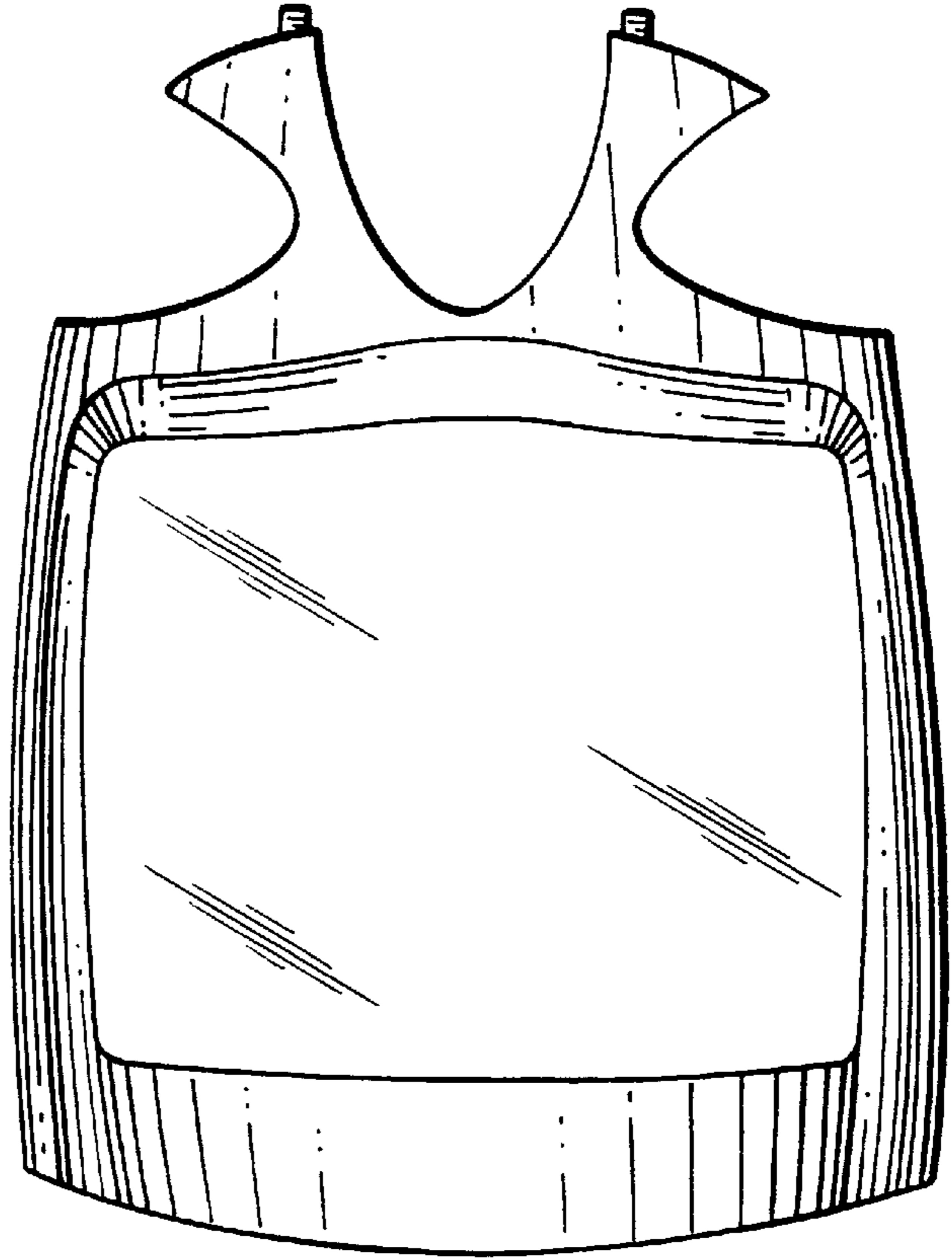

FIG. 4





FIG. 6

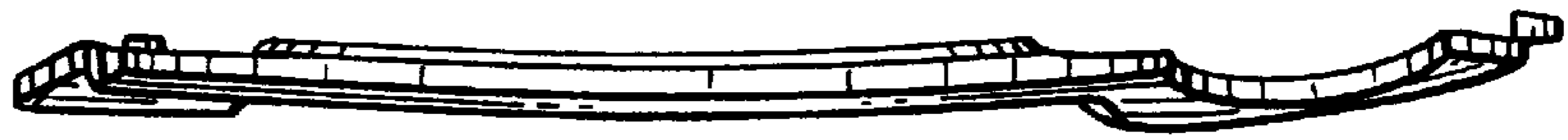

FIG. 7

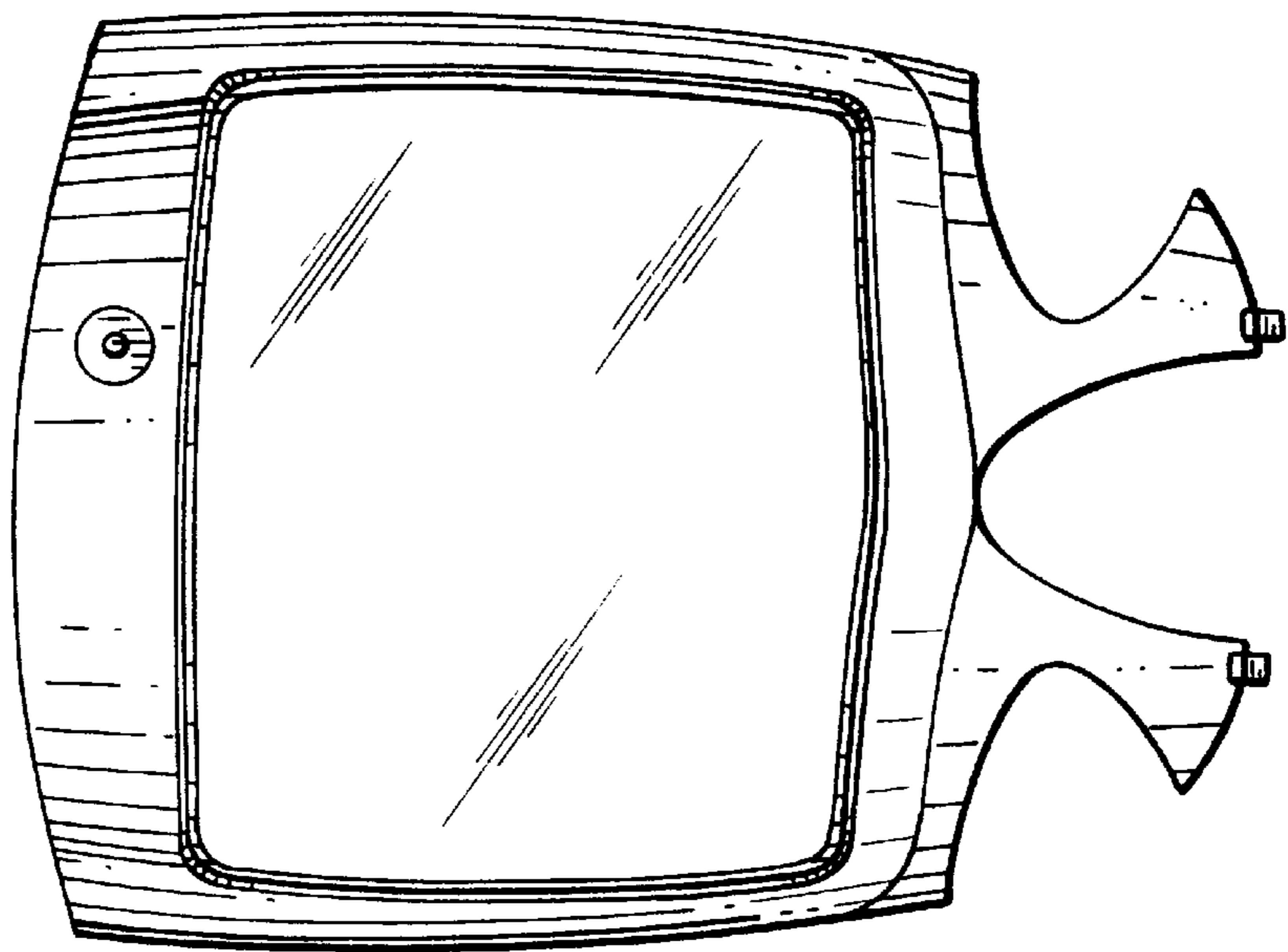

FIG. 8