



US00D426778S

United States Patent [19]
Kojima

[11] **Patent Number: Des. 426,778**
[45] **Date of Patent: ** Jun. 20, 2000**

[54] **WATCH CASE**
[75] **Inventor: Kenji Kojima**, Fussa, Japan
[73] **Assignee: Casio Keisanki Kabushiki Kaisha**,
Tokyo, Japan
[**] **Term: 14 Years**
[21] **Appl. No.: 29/108,724**
[22] **Filed: Aug. 2, 1999**
[51] **LOC (7) Cl. 10-02**
[52] **U.S. Cl. D10/30; D10/38**
[58] **Field of Search D10/1-40, 122-132;**
368/280-282, 276-277, 28-30, 285, 239-243,
82-84, 41-44

D. 412,854 9/1999 Oshita D10/30
D. 414,121 9/1999 Hanagata D10/30
D. 418,429 1/2000 Goto D10/30
D. 418,430 1/2000 Moriai D10/30
D. 418,761 1/2000 Iwamoto D10/30

Primary Examiner—Nelson C. Holtje
Attorney, Agent, or Firm—Frishauf, Holtz, Goodman,
Langer & Chick, P.C.

[57] **CLAIM**

The ornamental design for watch case, as shown.

DESCRIPTION

FIG. 1 is a front elevational view of watch case showing my new design;
FIG. 2 is a right side elevational view thereof;
FIG. 3 is a left side elevational view thereof;
FIG. 4 is a top plan view thereof;
FIG. 5 is a bottom plan view thereof;
FIG. 6 is a rear elevational view thereof; and,
FIG. 7 is a perspective view thereof.

[56] **References Cited**
U.S. PATENT DOCUMENTS
D. 394,397 5/1998 Goto D10/30
D. 402,566 12/1998 Moriai D10/30

1 Claim, 3 Drawing Sheets

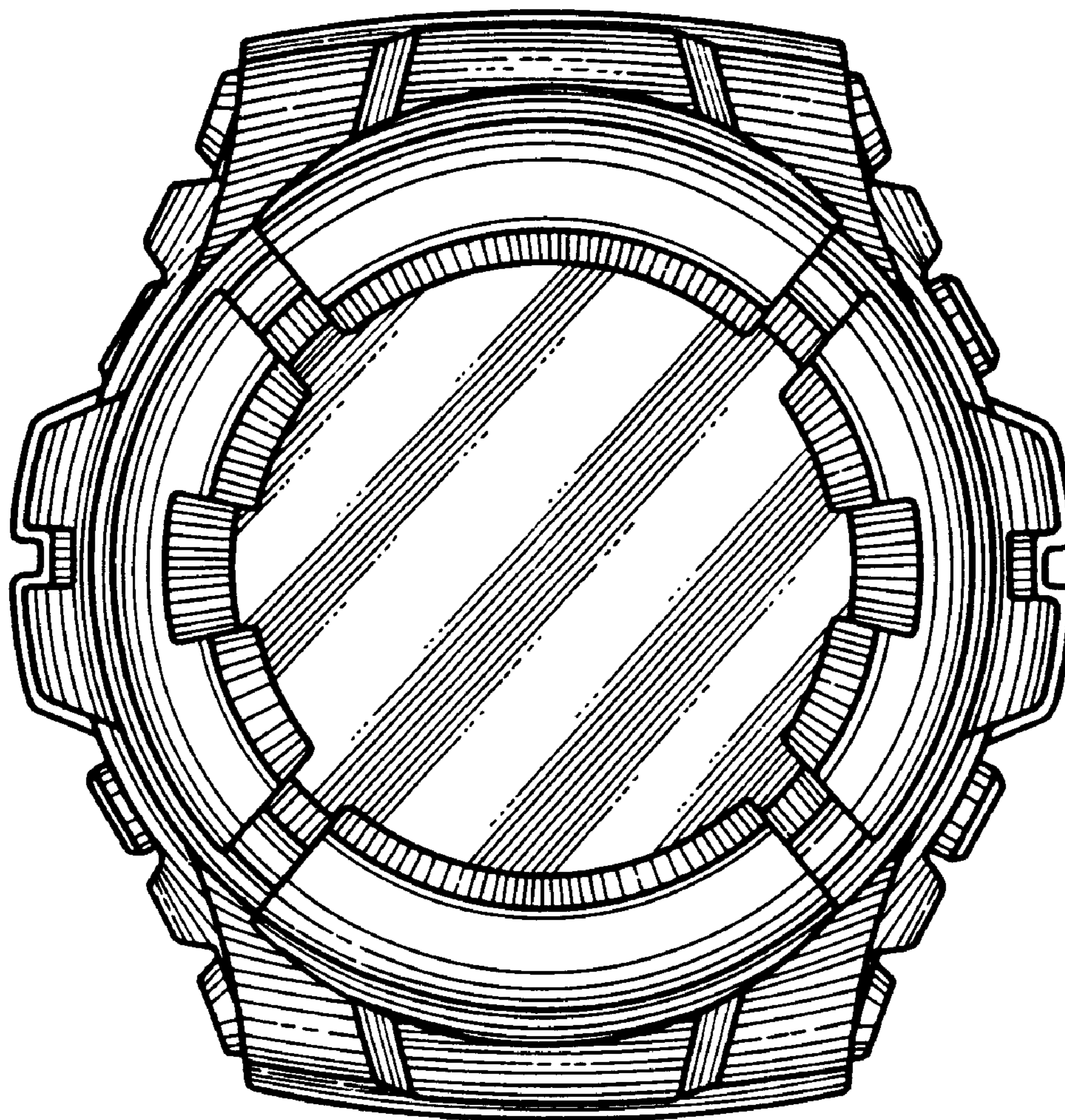

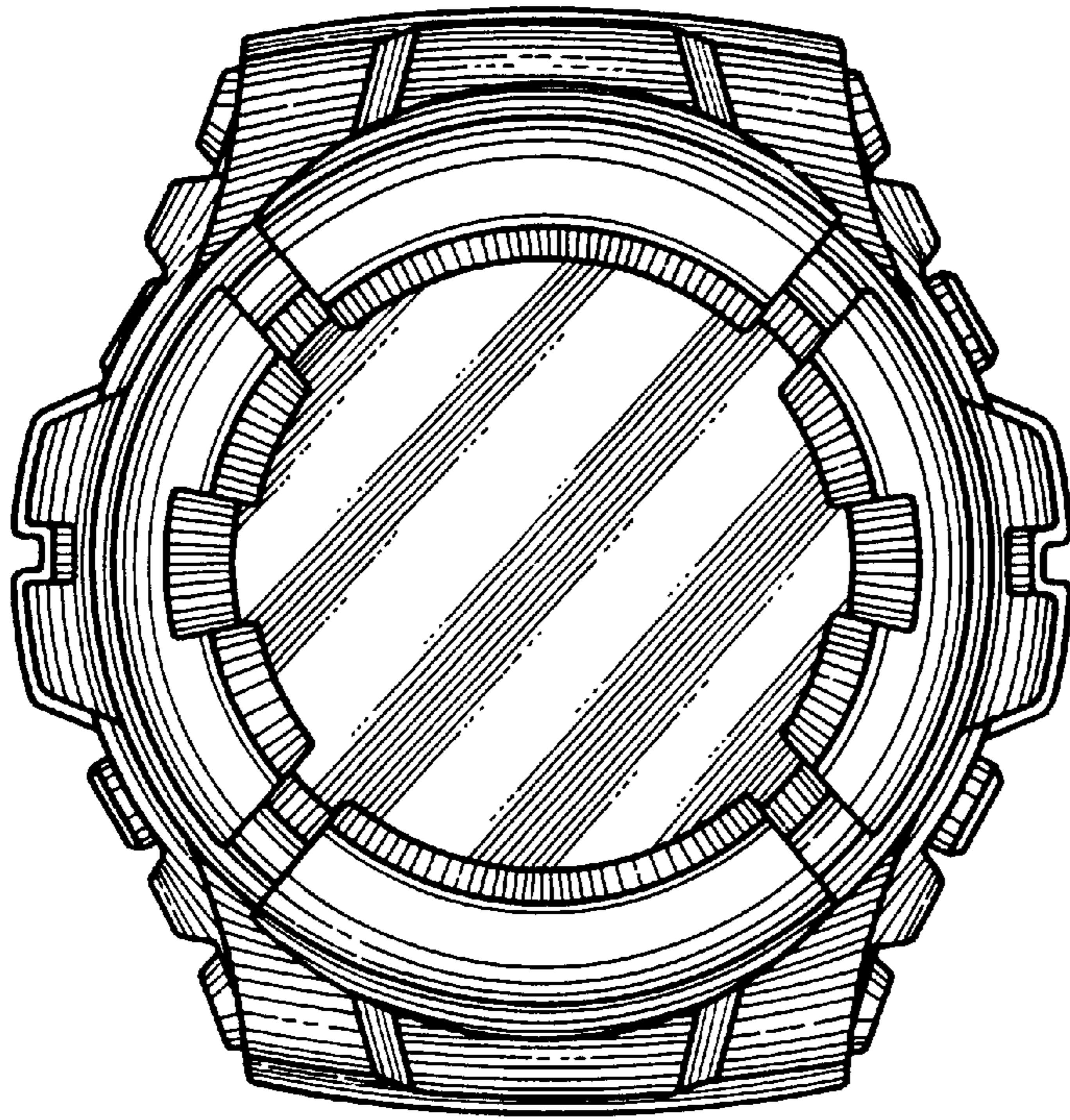

FIG. 1

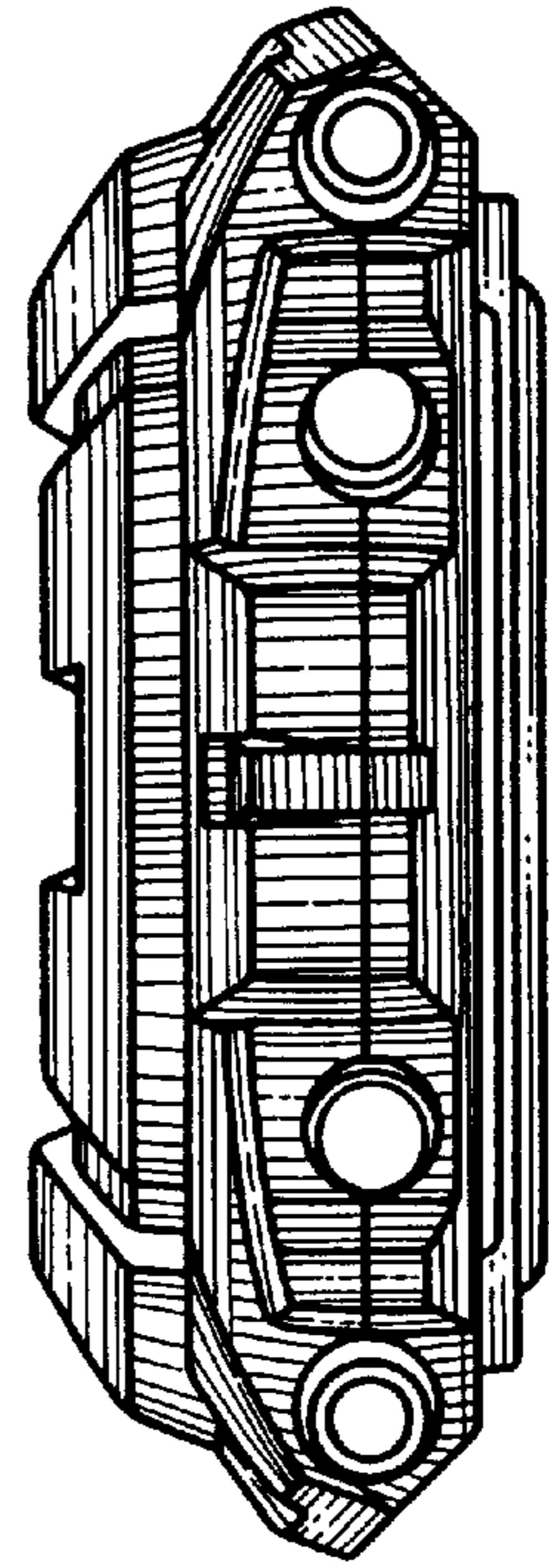

FIG. 2

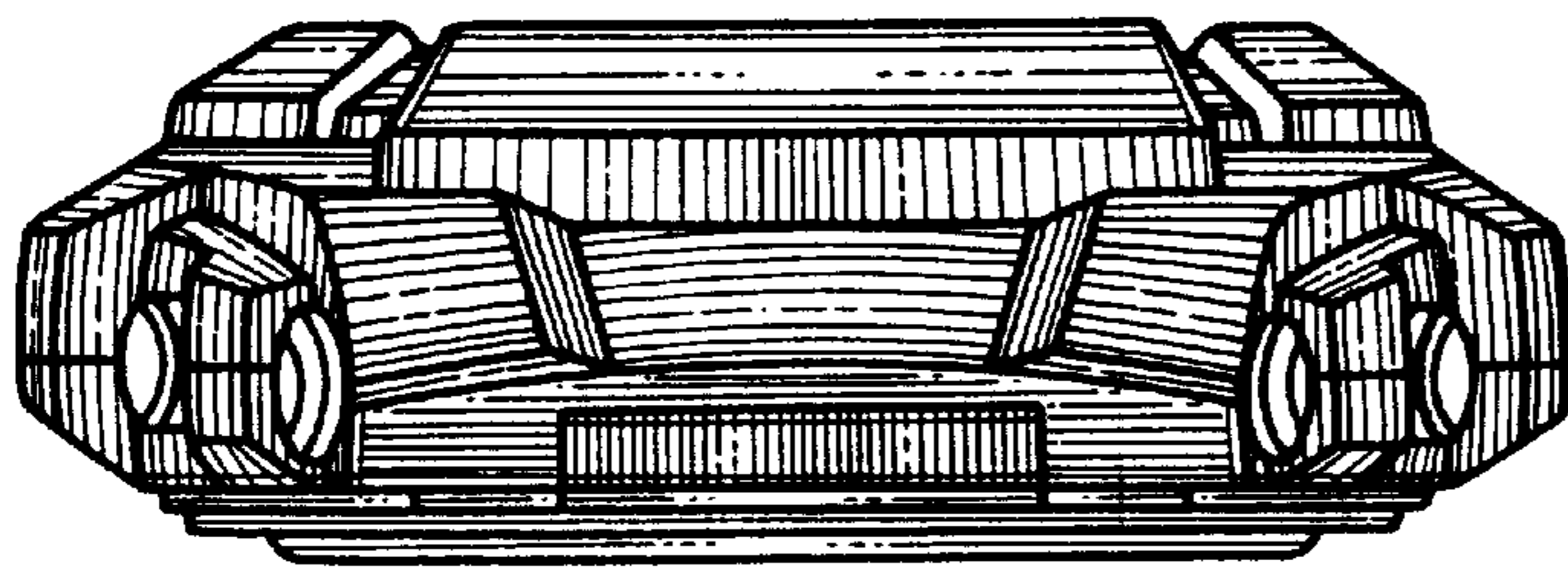

FIG. 5

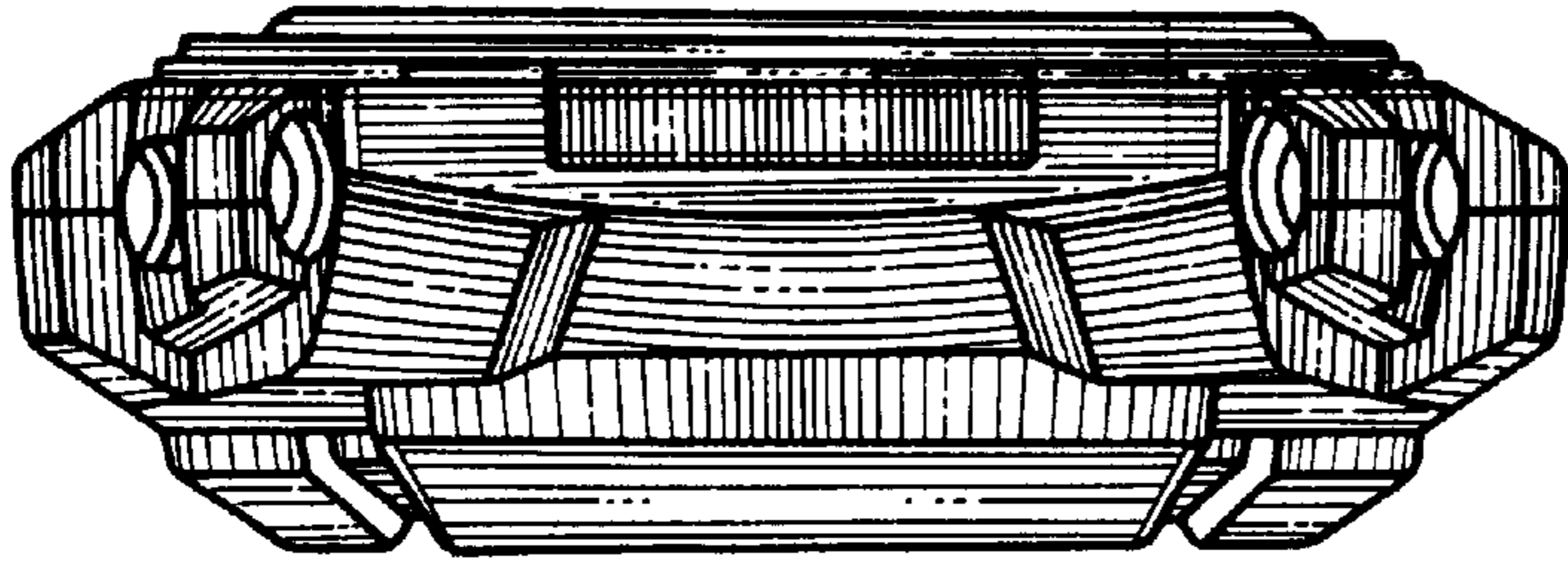

FIG. 4

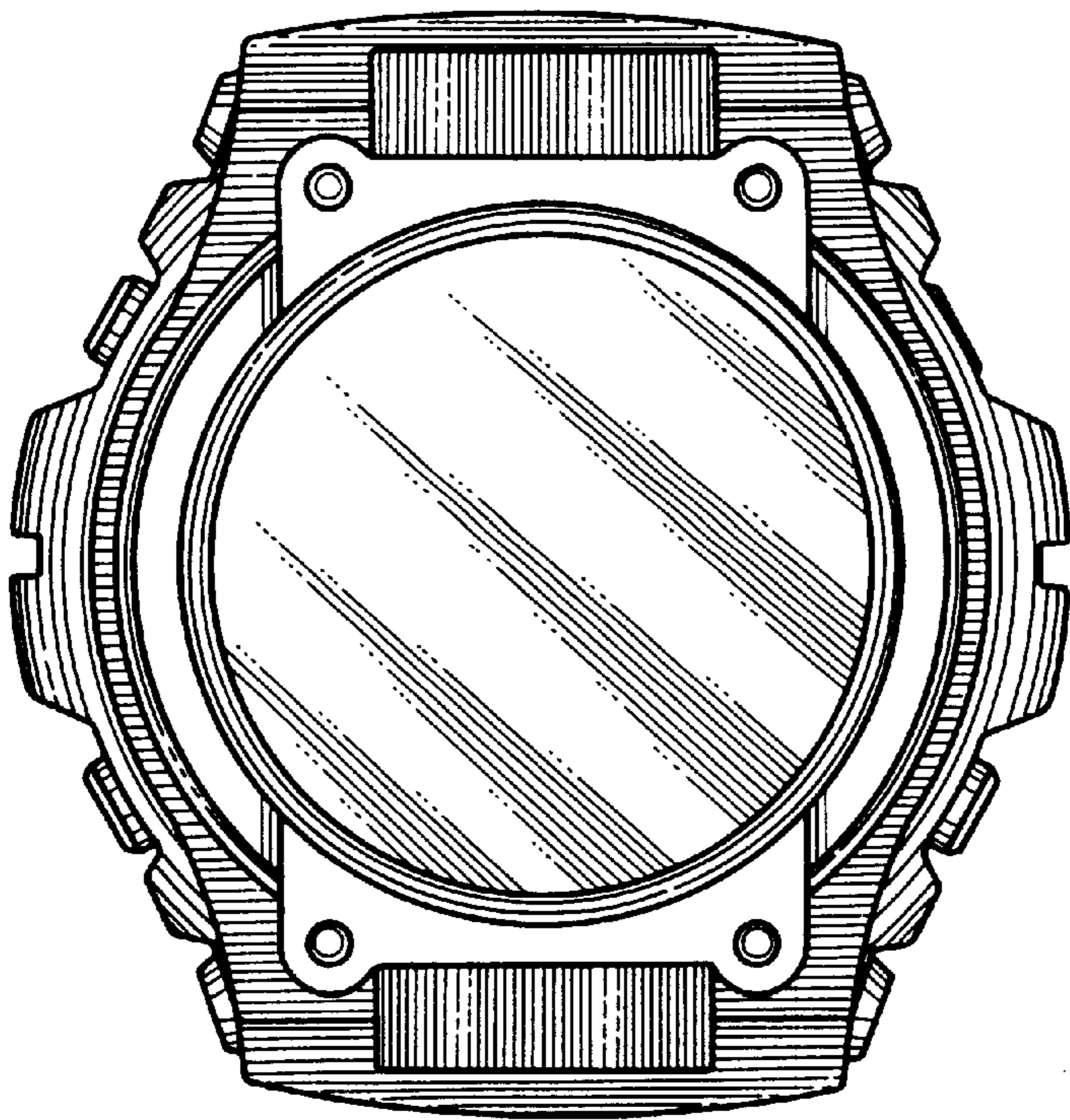

FIG. 6

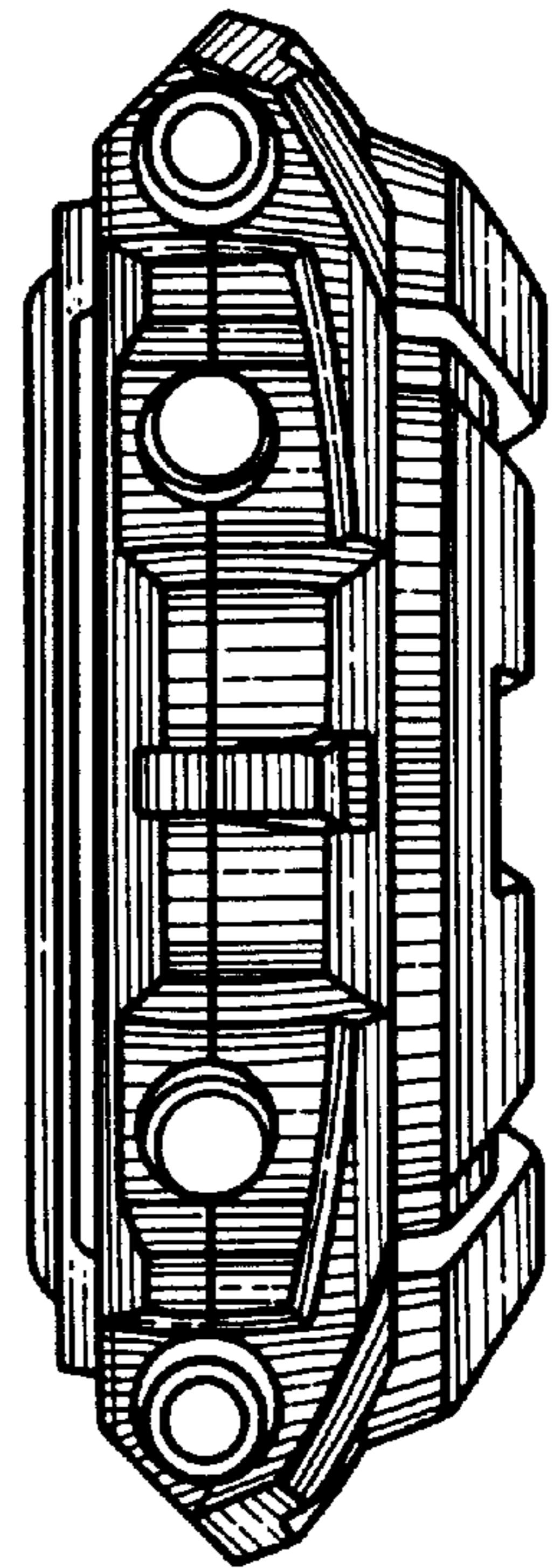

FIG. 3

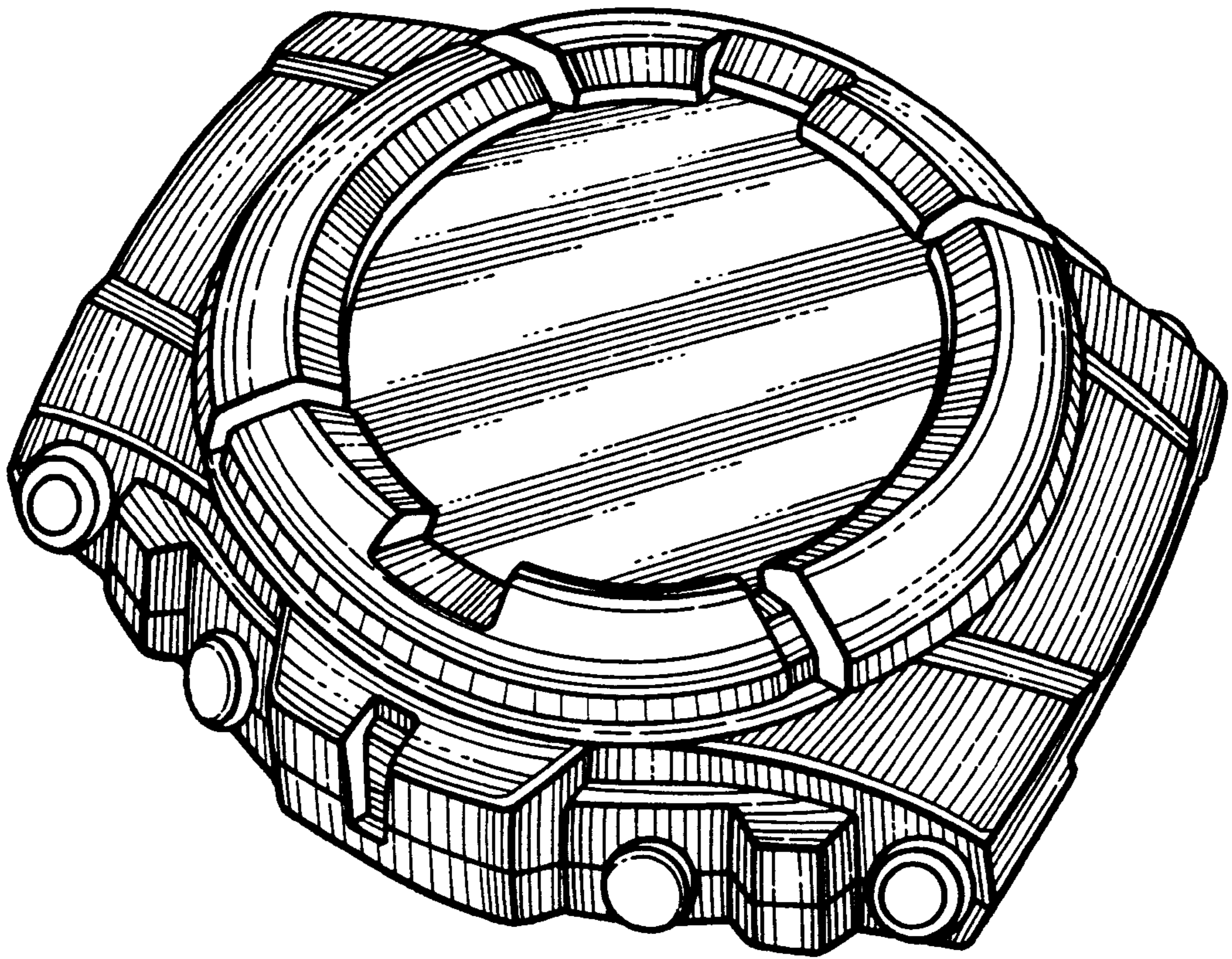

FIG. 7