



US00D426752S

United States Patent [19] Whaley

[11] Patent Number: **Des. 426,752**

[45] Date of Patent: **** Jun. 20, 2000**

[54] **CUP HOLDER**

[76] Inventor: **Robin Whaley**, 101 S. Harden St. #1,
Columbia, S.C. 29205

[**] Term: **14 Years**

[21] Appl. No.: **29/111,581**

[22] Filed: **Sep. 29, 1999**

[51] **LOC (7) Cl.** **07-06**

[52] **U.S. Cl.** **D7/619**

[58] **Field of Search** D7/619-625, 608;
215/386, 395; 220/737-739; 248/311.2,
346.11

5,112,017 5/1992 Pang 248/311.2
5,566,917 10/1996 Wu 248/311.2
5,590,861 1/1997 Ardolino 248/146
5,906,348 5/1999 Orenstein 248/311.2

Primary Examiner—Terry A. Wallace
Attorney, Agent, or Firm—Leatherwood Walker Todd &
Mann, P.C.

[57] CLAIM

The ornamental design for a cup holder, as shown and described.

DESCRIPTION

FIG. 1 is a perspective view of a cup holder showing my new design;
FIG. 2 is a bottom perspective view thereof;
FIG. 3 is a plan view thereof;
FIG. 4 is a front elevational view thereof;
FIG. 5 is a rear elevational view thereof;
FIG. 6 is a bottom plan view thereof; and,
FIG. 7 is a right side elevational view thereof.

1 Claim, 4 Drawing Sheets

[56] References Cited

U.S. PATENT DOCUMENTS

D. 236,175	8/1975	Wintz .	
3,994,465	11/1976	Rudnitzky	248/311.1
4,248,397	2/1981	Casper	248/138
4,508,303	4/1985	Beckerer, Jr.	248/311.2
4,844,400	7/1989	Jasmagy, Jr.	248/311.2
5,102,086	4/1992	Thomason	248/311.2

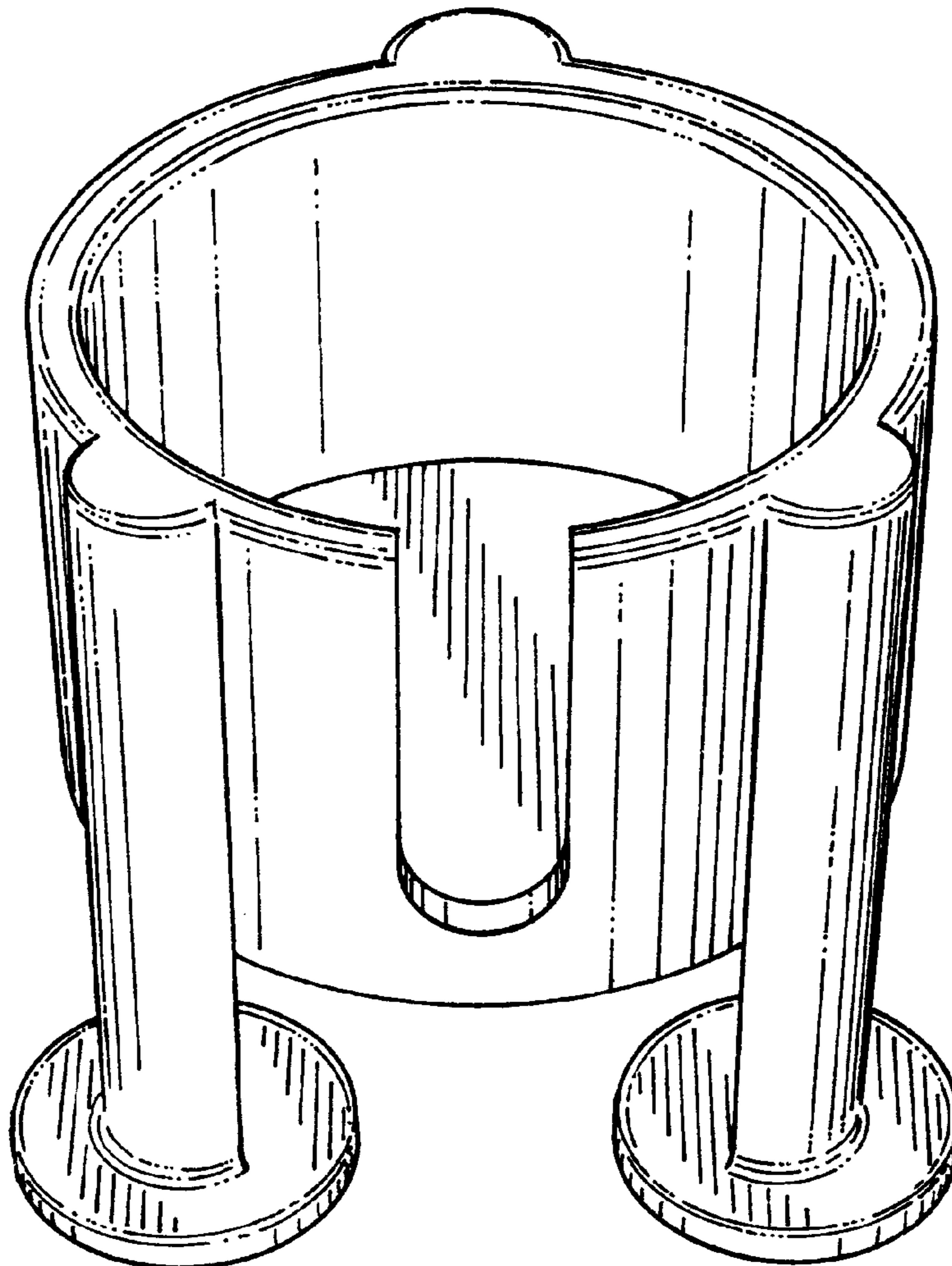

Fig. 1

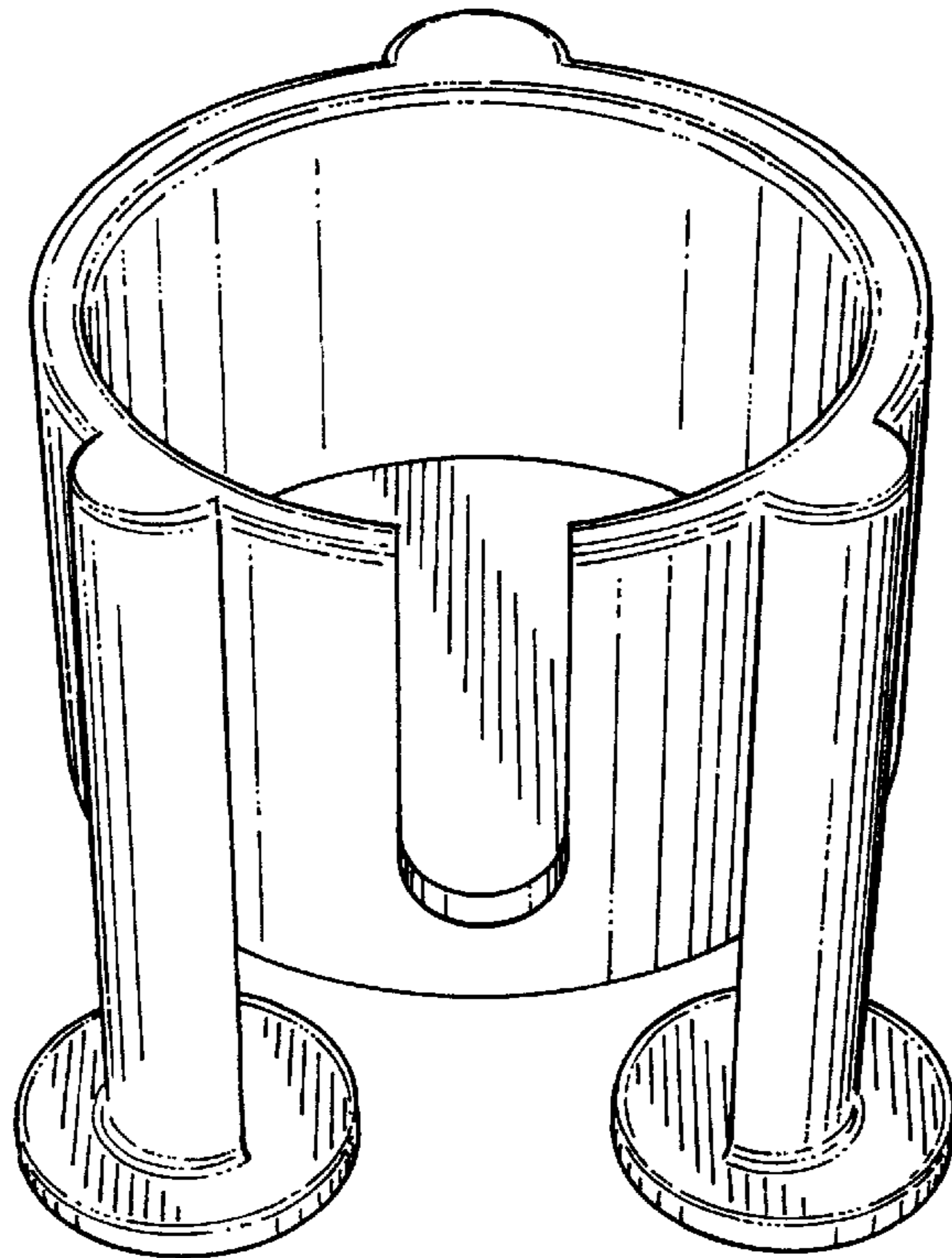
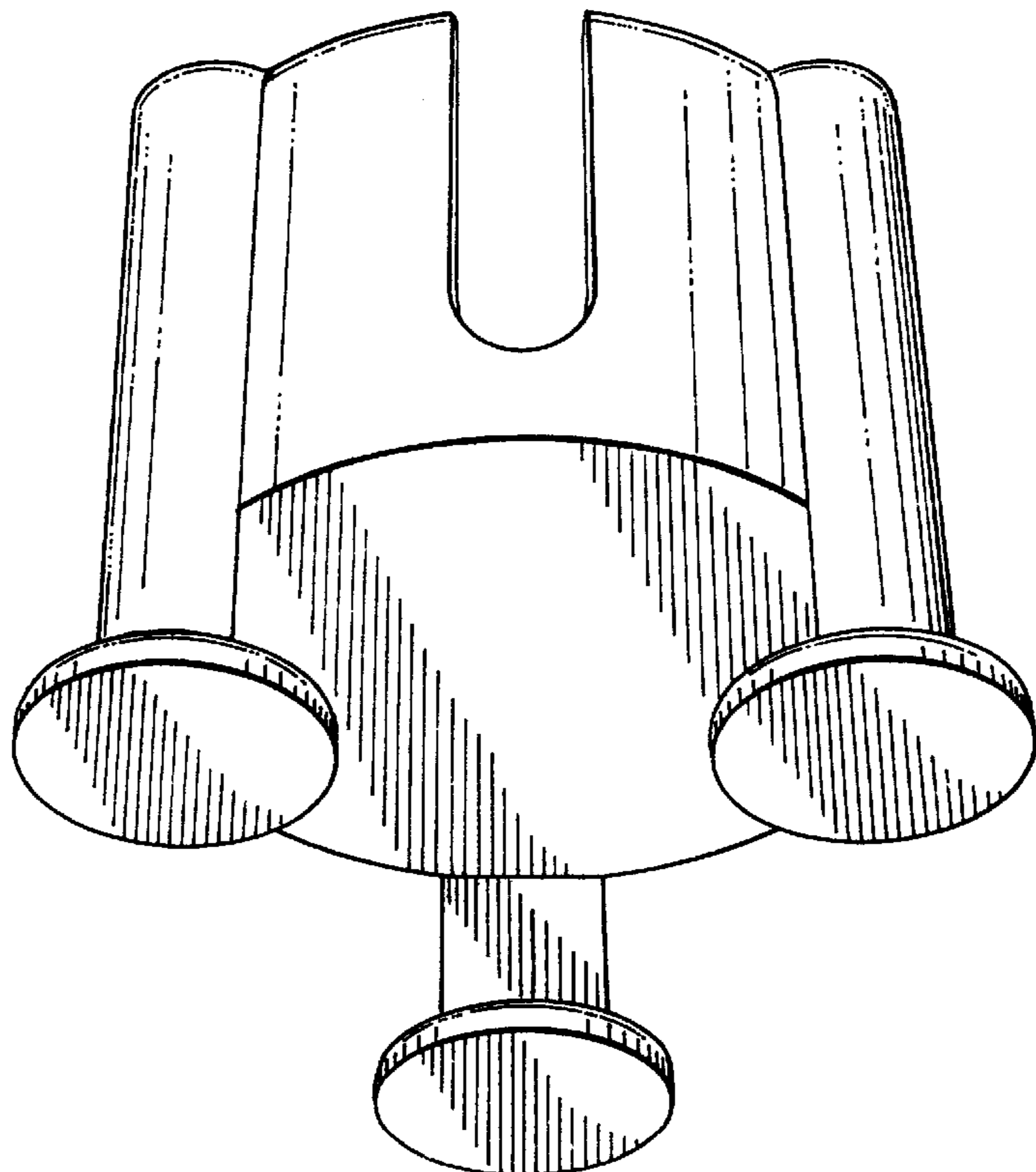

Fig. 2



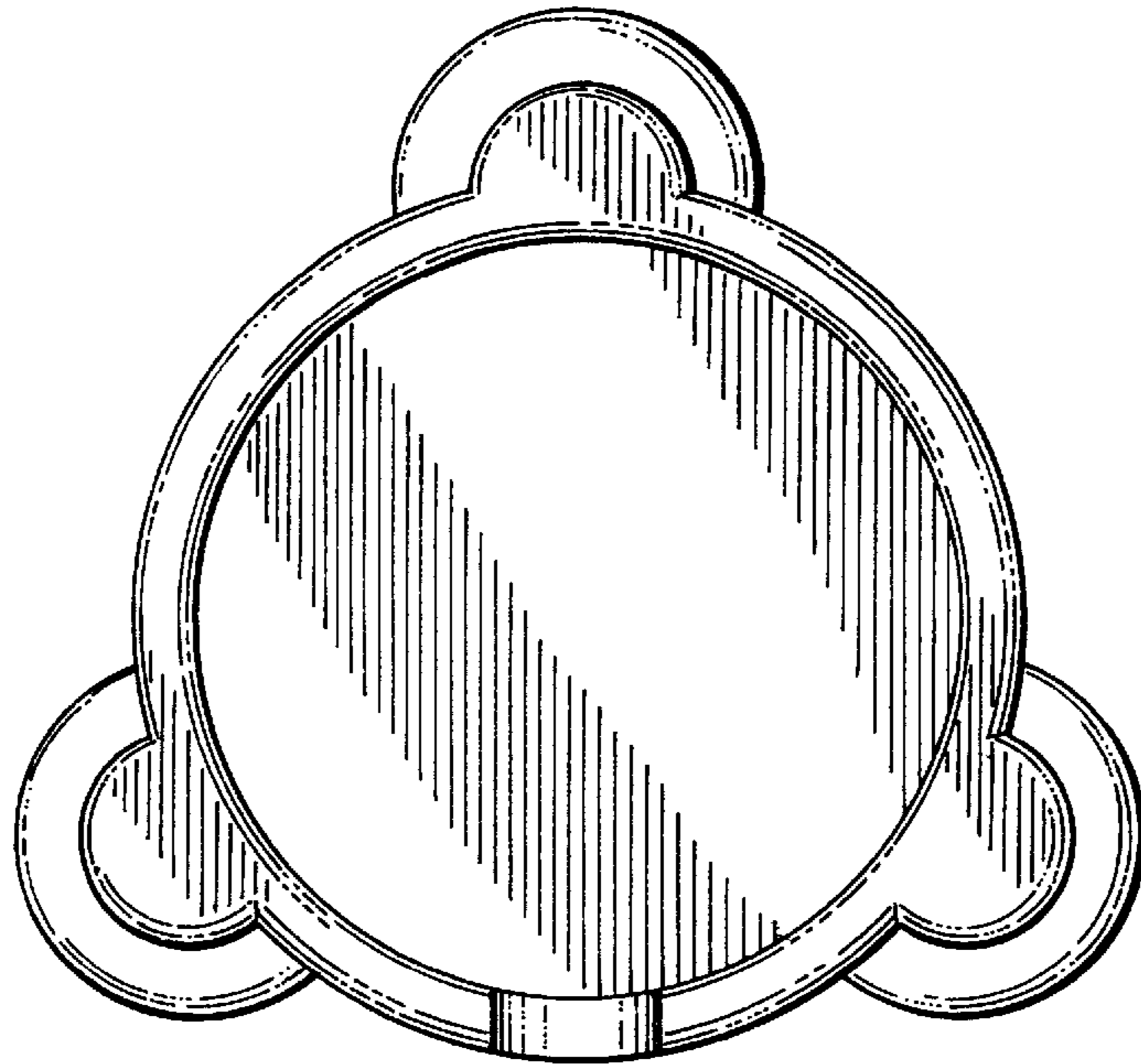

Fig. 3

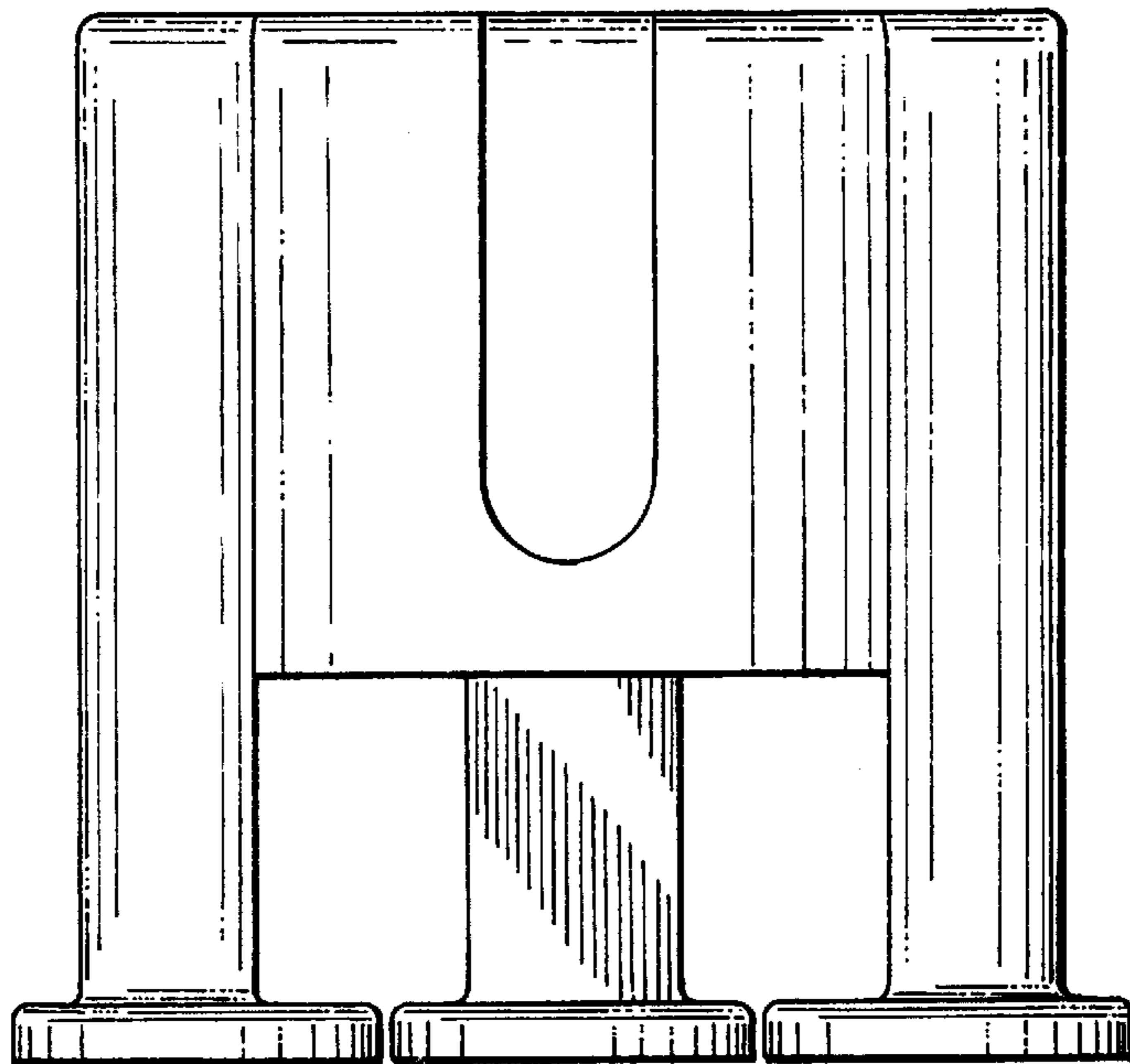

Fig. 4

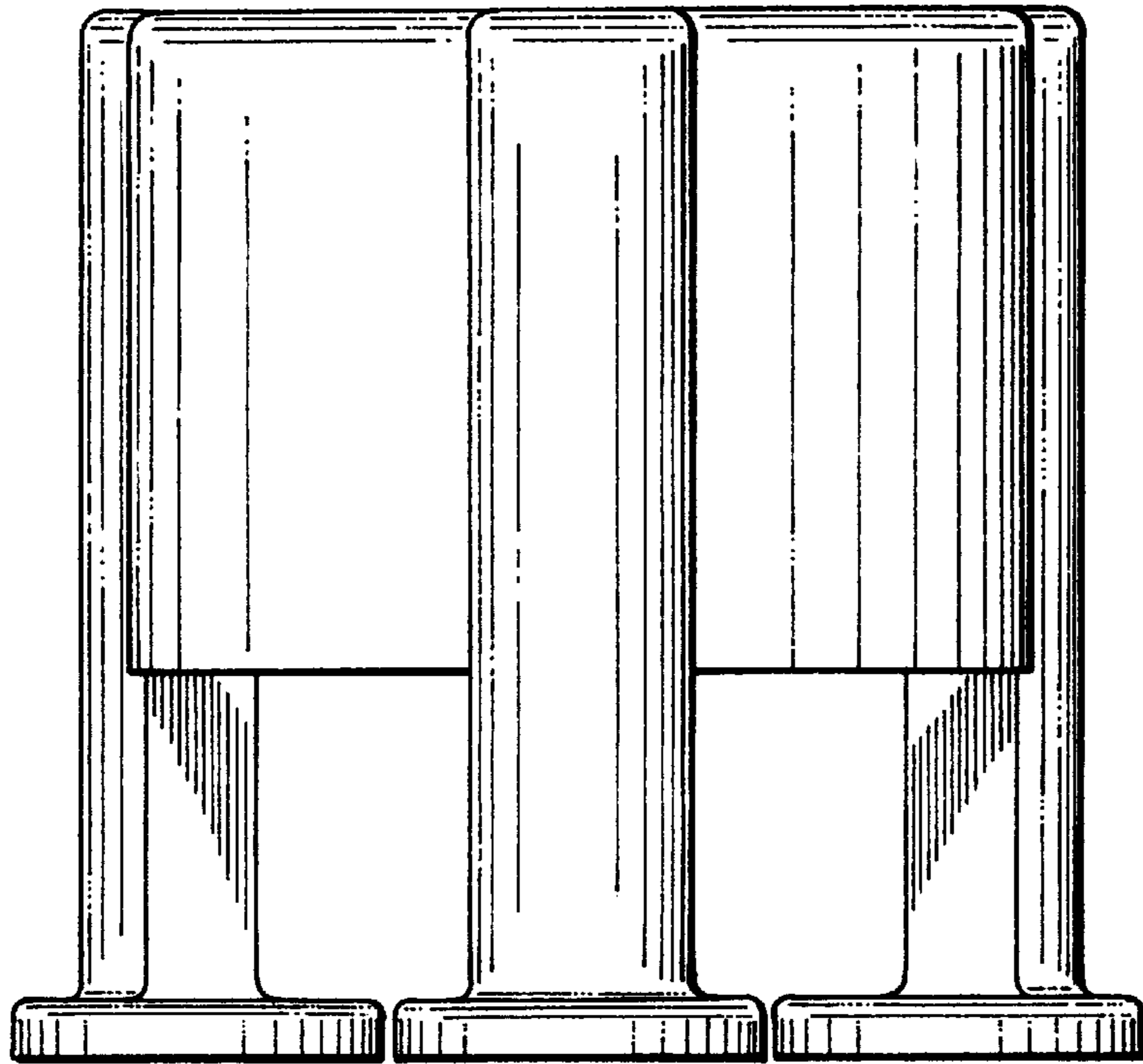

Fig. 5

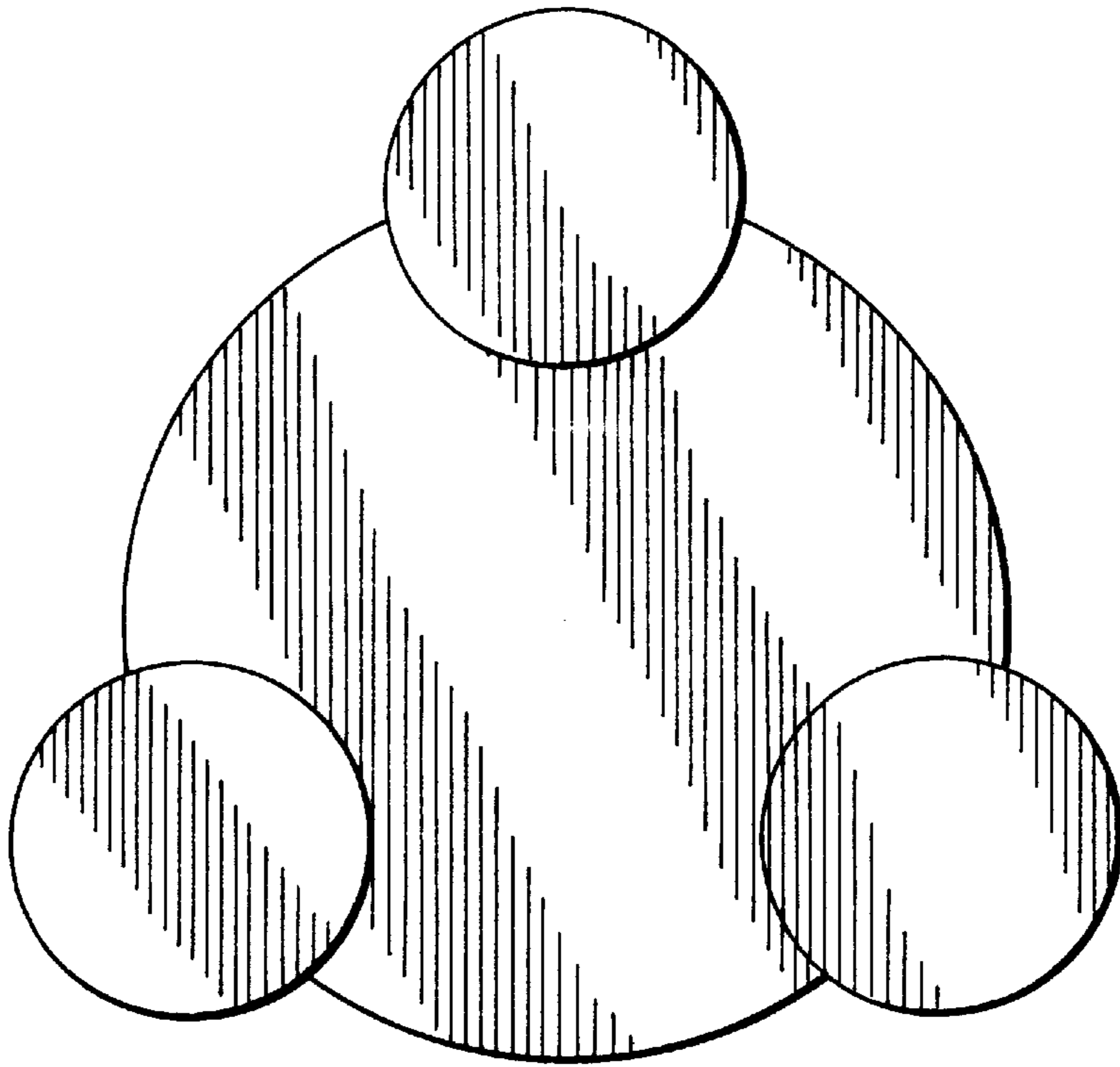

Fig. 6

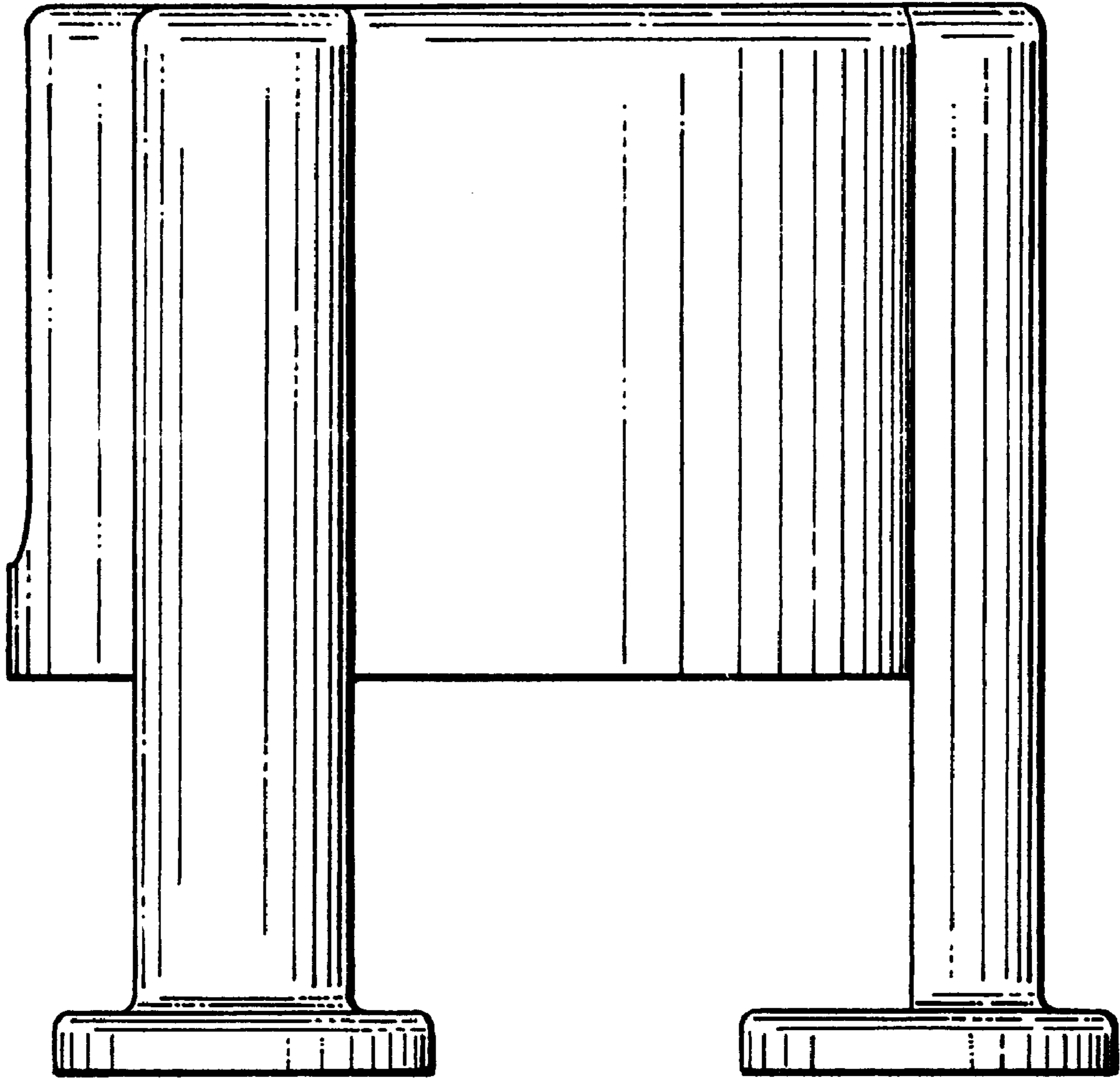

Fig. 7