



US00D426726S

United States Patent [19]

Fenwick, Jr.

[11] Patent Number: **Des. 426,726**

[45] Date of Patent: **** Jun. 20, 2000**

[54] **SHOE RACK**

[76] Inventor: **Edward Keith Fenwick, Jr.**, 801 Devilfish Dr., Oxnard, Calif. 93035

[**] Term: **14 Years**

[21] Appl. No.: **29/111,836**

[22] Filed: **Oct. 5, 1999**

[51] **LOC (7) Cl.** **06-04**

[52] **U.S. Cl.** **D6/464**

[58] **Field of Search** D6/411, 462-468; 211/34, 36, 37, 38, 41.4, 119; 220/485, 487

[56] **References Cited**

U.S. PATENT DOCUMENTS

- D. 318,196 7/1991 Sheng D6/411 X
- D. 324,142 2/1992 Cassel D6/411 X

- D. 384,224 9/1997 Dickinson et al. D6/462 X
- D. 416,146 11/1999 Dickinson et al. D6/463

Primary Examiner—Cathron B. Matta
Attorney, Agent, or Firm—Goldstein & Canino

[57] **CLAIM**

The ornamental design for a shoe rack, as shown and described.

DESCRIPTION

FIG. 1 is a perspective view of a shoe rack.
 FIG. 2 is a front elevational view thereof.
 FIG. 3 is a rear elevational view thereof.
 FIG. 4 is a left side elevational view thereof, the right side elevational view being a mirror image of the left side view.
 FIG. 5 is a top plan view of the shoe rack; and,
 FIG. 6 is a bottom plan view thereof.

1 Claim, 4 Drawing Sheets

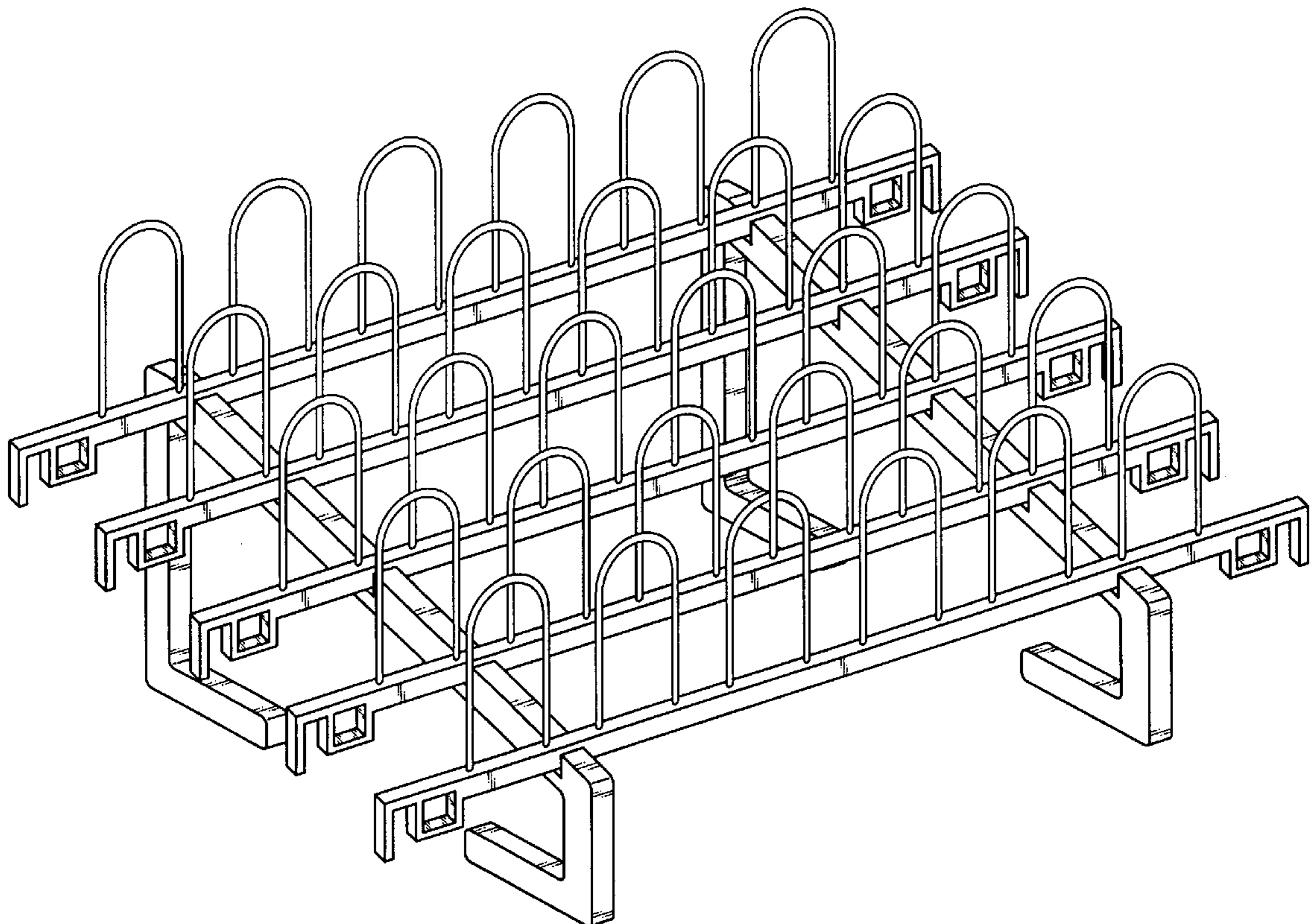

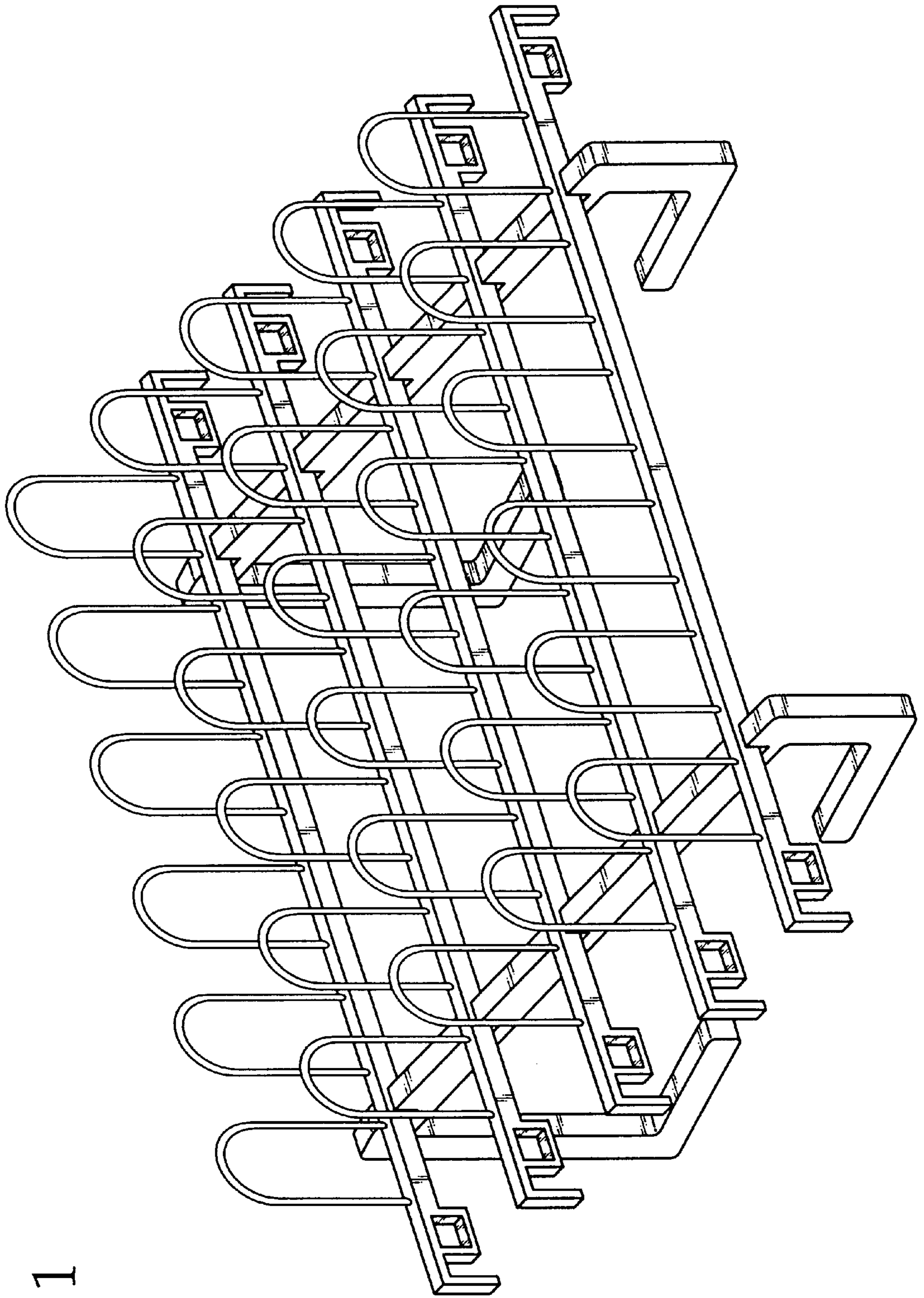

FIG. 1

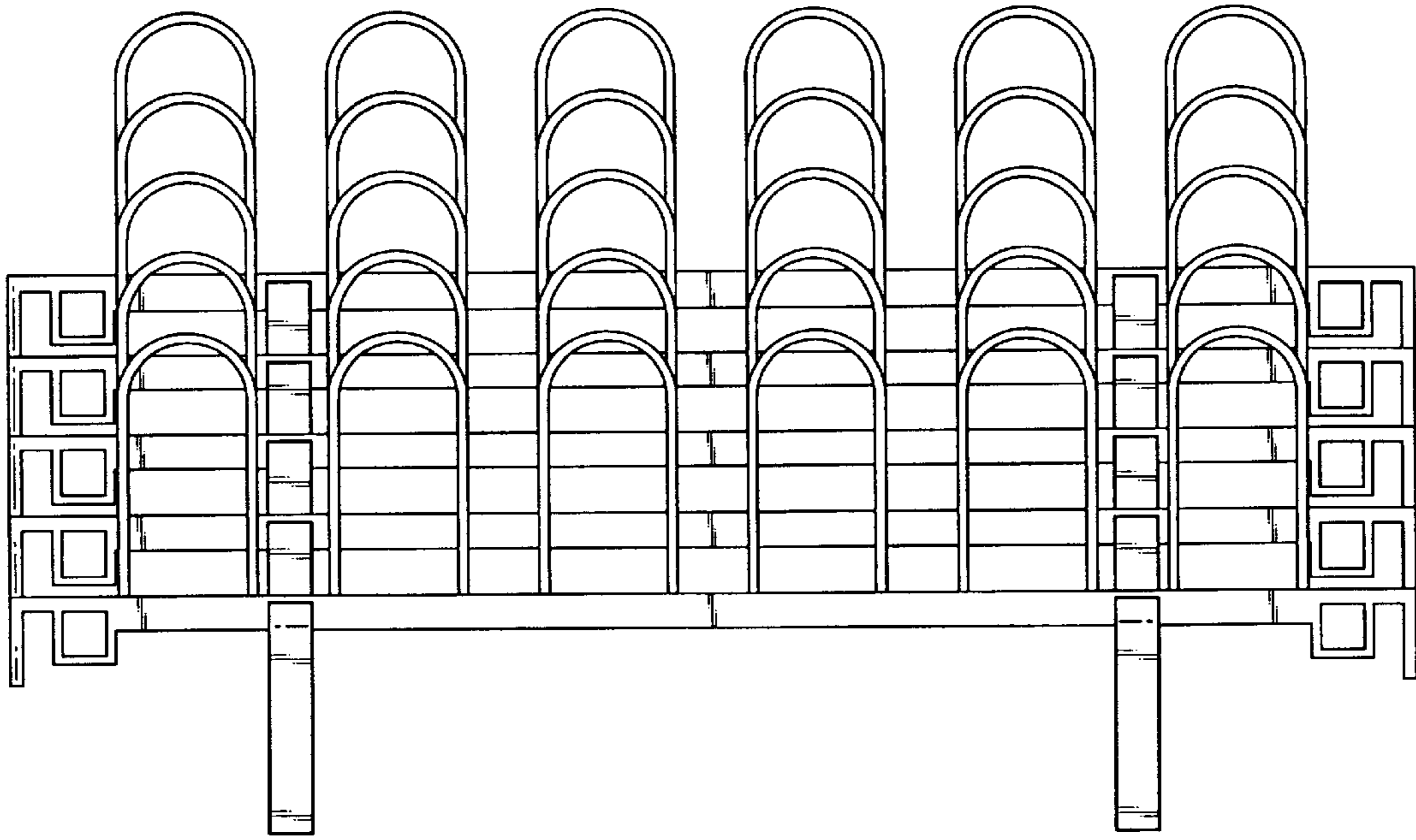

FIG. 2

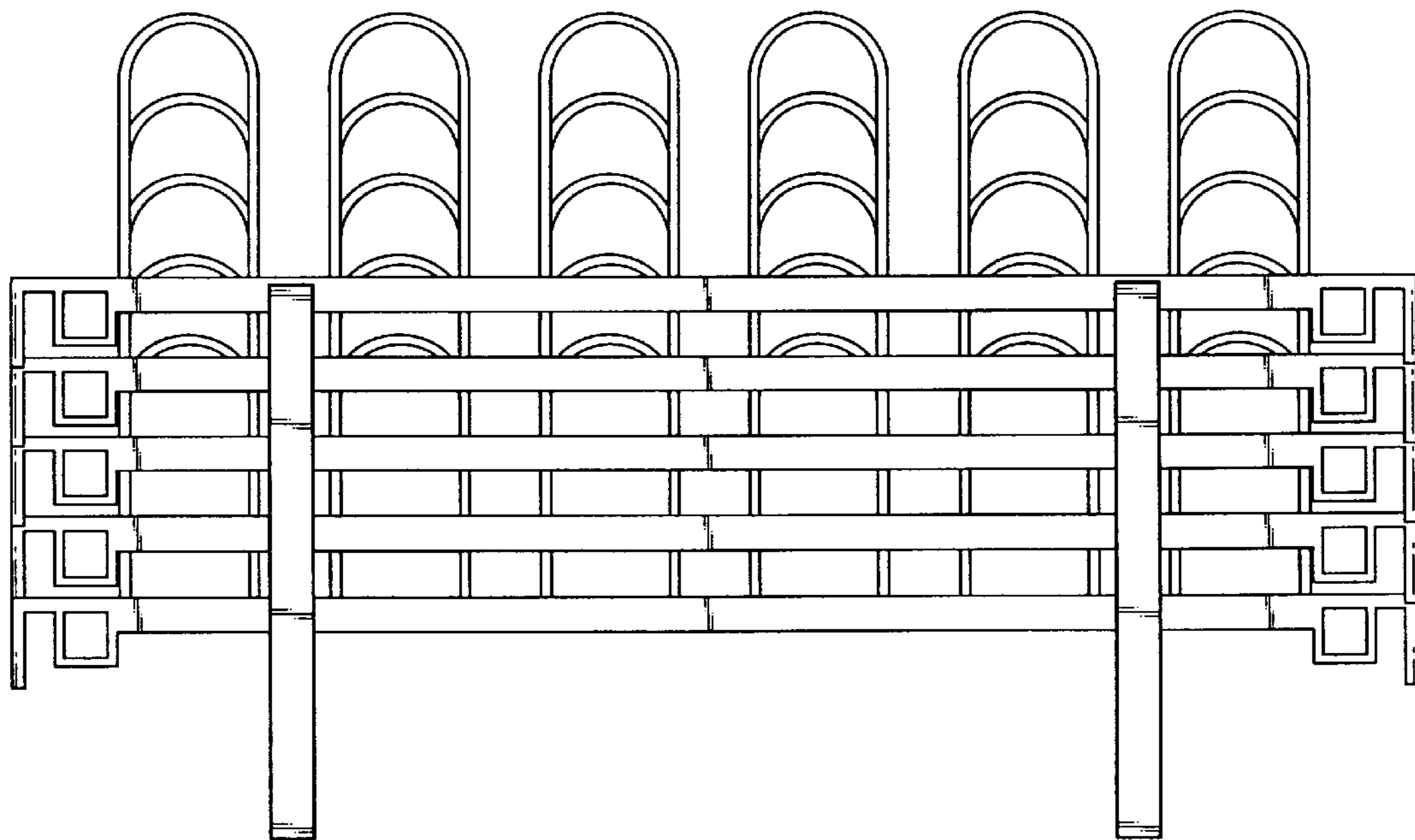

FIG. 3

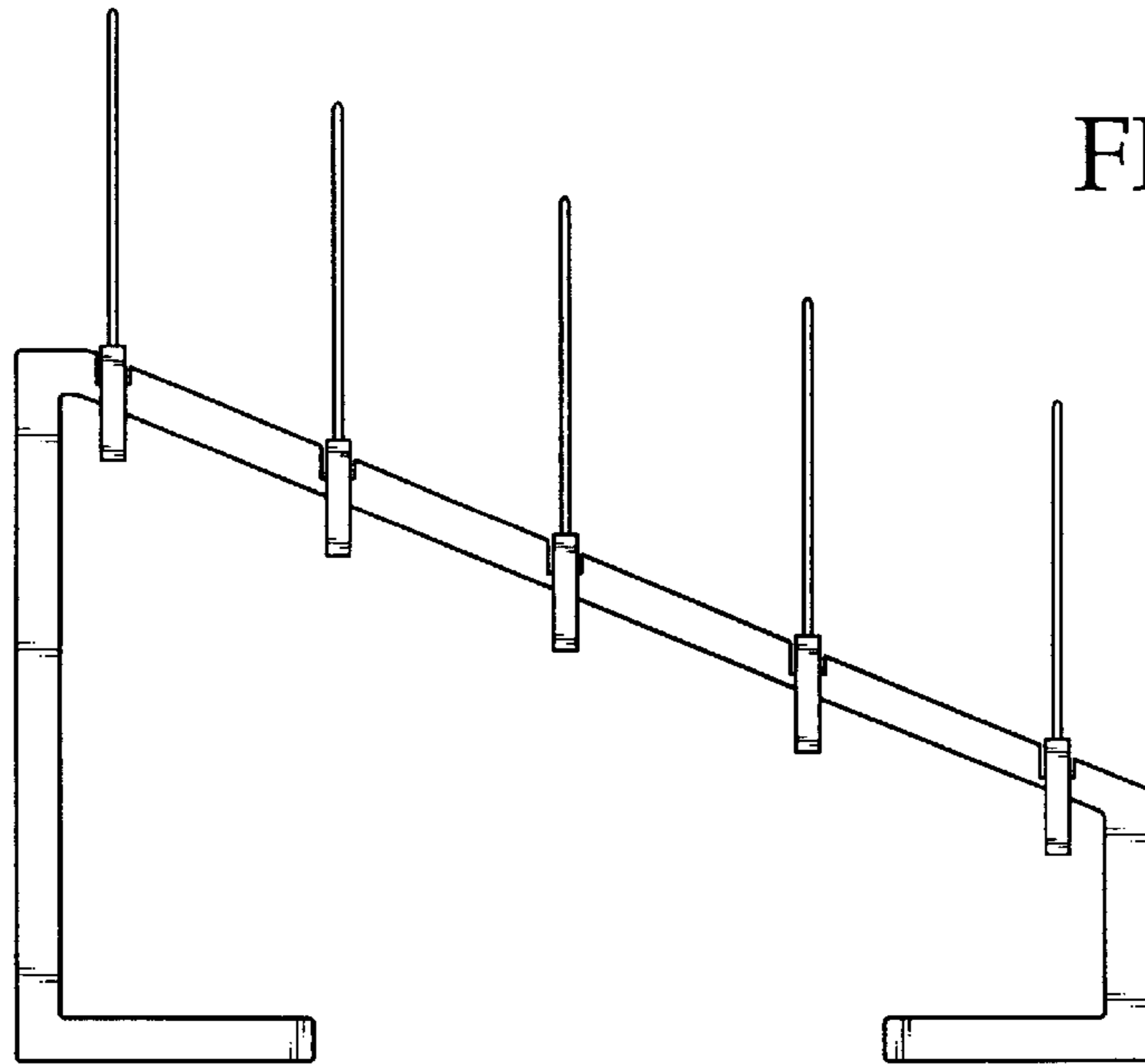
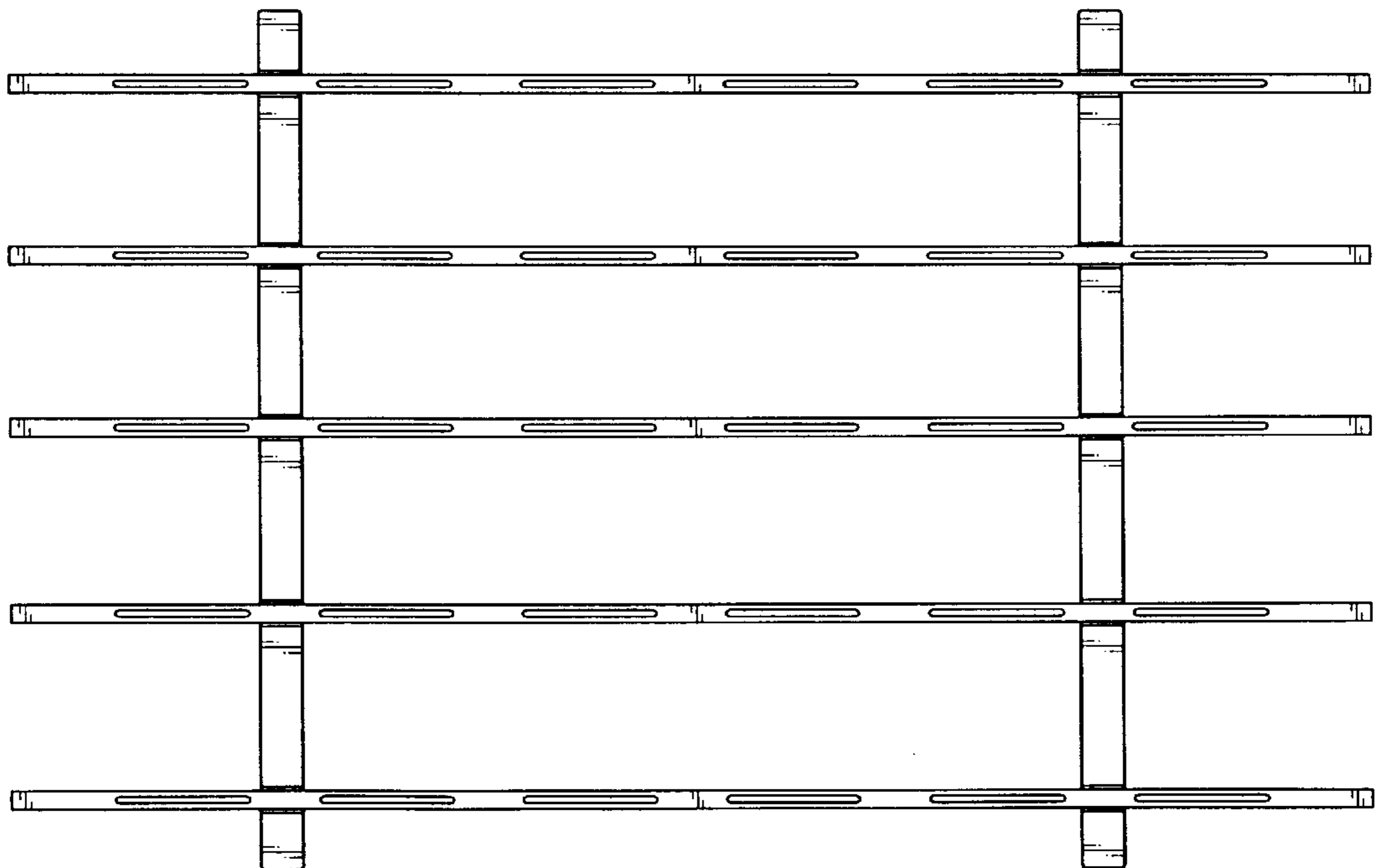

FIG. 4

FIG. 5



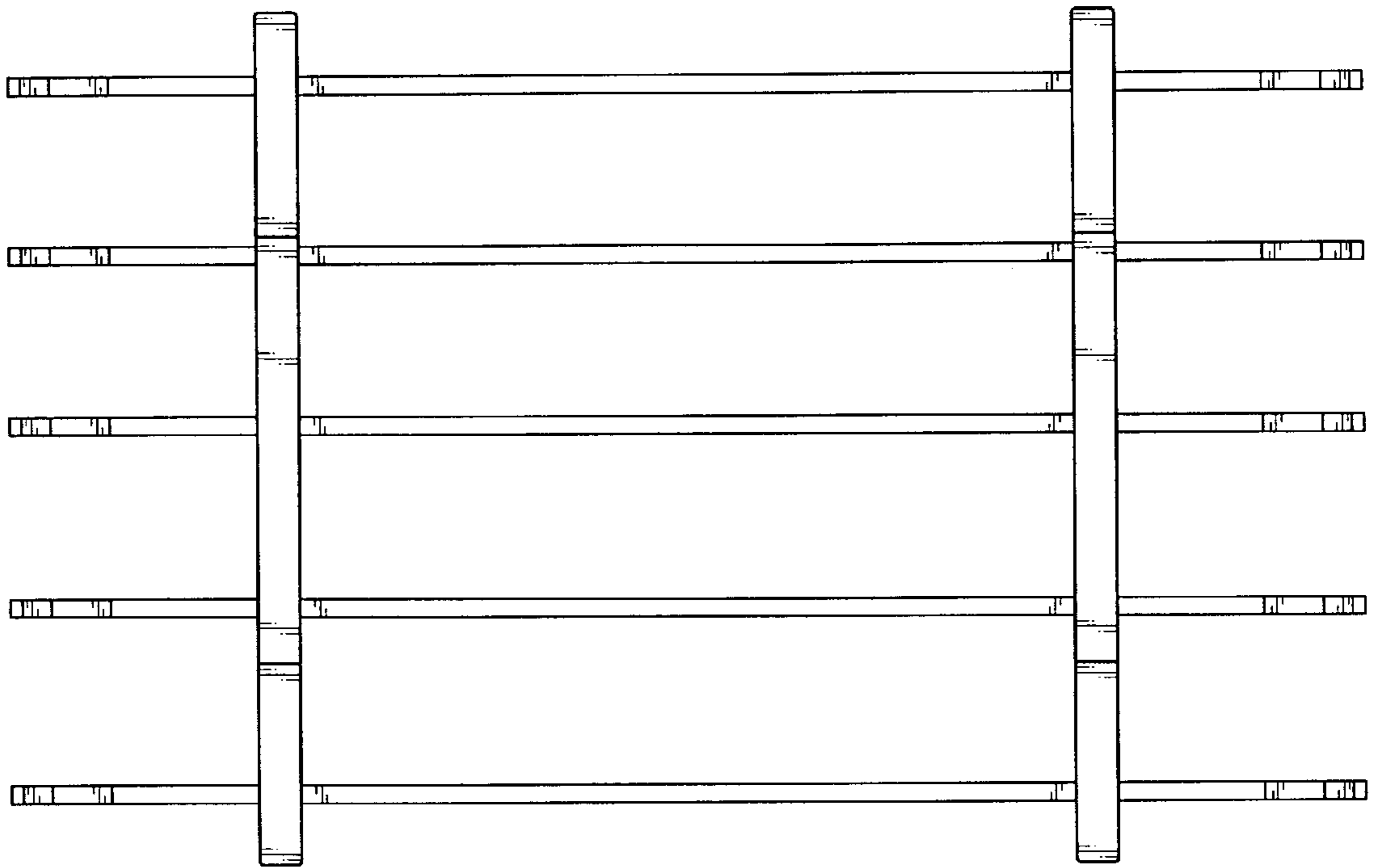

FIG. 6