



US00D426533S

United States Patent [19]

[11] Patent Number: **Des. 426,533**

Hughes et al.

[45] Date of Patent: **** Jun. 13, 2000**

[54] TELEPHONE

[75] Inventors: **Steve Hughes**, Horsham; **Stascha Offenback**, London, both of United Kingdom; **Rie Isono**, Yokohama, Japan

[73] Assignee: **Swatch AG**, Bienne, Switzerland

[**] Term: **14 Years**

[21] Appl. No.: **29/108,361**

[22] Filed: **Jul. 26, 1999**

D. 367,274	2/1996	Gobindram	D14/149
D. 380,729	7/1997	Richards et al.	D13/108
D. 382,265	8/1997	Bradley et al.	D14/149
D. 384,672	10/1997	Heberling	D14/242
D. 399,842	10/1998	Matsuda et al.	D14/150
4,875,234	10/1989	Tragatschnig	379/434
5,656,914	8/1997	Nagele et al.	320/110

Primary Examiner—Jeffrey Asch
Attorney, Agent, or Firm—Collen Law Associates, P.C.

Related U.S. Application Data

[62] Division of application No. 29/086,643, Apr. 16, 1998.

Foreign Application Priority Data

Nov. 25, 1997 [WO] WIPO DM/042101

[51] **LOC (7) Cl.** **14-03**

[52] **U.S. Cl.** **D14/149**

[58] **Field of Search** D14/137, 243, D14/138, 242, 148, 147, 149–151, 140–142, 240, 241, 251, 253, 155, 159; 379/433–436, 419, 420, 428, 440, 454, 455, 446, 447; D13/107, 108; 320/110, 113, 114, 115

References Cited

U.S. PATENT DOCUMENTS

D. 274,048	5/1984	Wong et al.	D14/242
D. 292,283	10/1987	Matsuda et al.	D14/240
D. 300,628	4/1989	Wu	D14/151
D. 311,397	10/1990	Cheng	D14/149
D. 352,944	11/1994	Lee	D14/151
D. 355,416	2/1995	McCay et al.	D14/137

[57] CLAIM

The ornamental design for a telephone, as shown and described.

DESCRIPTION

FIG. 1 is a top view of our new and ornamental design for a telephone;
 FIG. 2 is a bottom view thereof;
 FIG. 3 is a front view thereof;
 FIG. 4 is a rear view thereof;
 FIG. 5 is a left side view thereof;
 FIG. 6 is a right side view thereof;
 FIG. 7 is a top, right, front perspective view thereof;
 FIG. 8 is a top view of an alternative embodiment of that shown in FIG. 1;
 FIG. 9 is a bottom view thereof;
 FIG. 10 is a front view thereof;
 FIG. 11 is a rear view thereof;
 FIG. 12 is a left side view thereof;
 FIG. 13 is a right side view thereof; and,
 FIG. 14 is a top, right, front perspective view thereof.
 The broken line showings of FIGS. 1, 7, 8, and 14 are for illustrative purposes only and form no part of the claimed design.

1 Claim, 10 Drawing Sheets

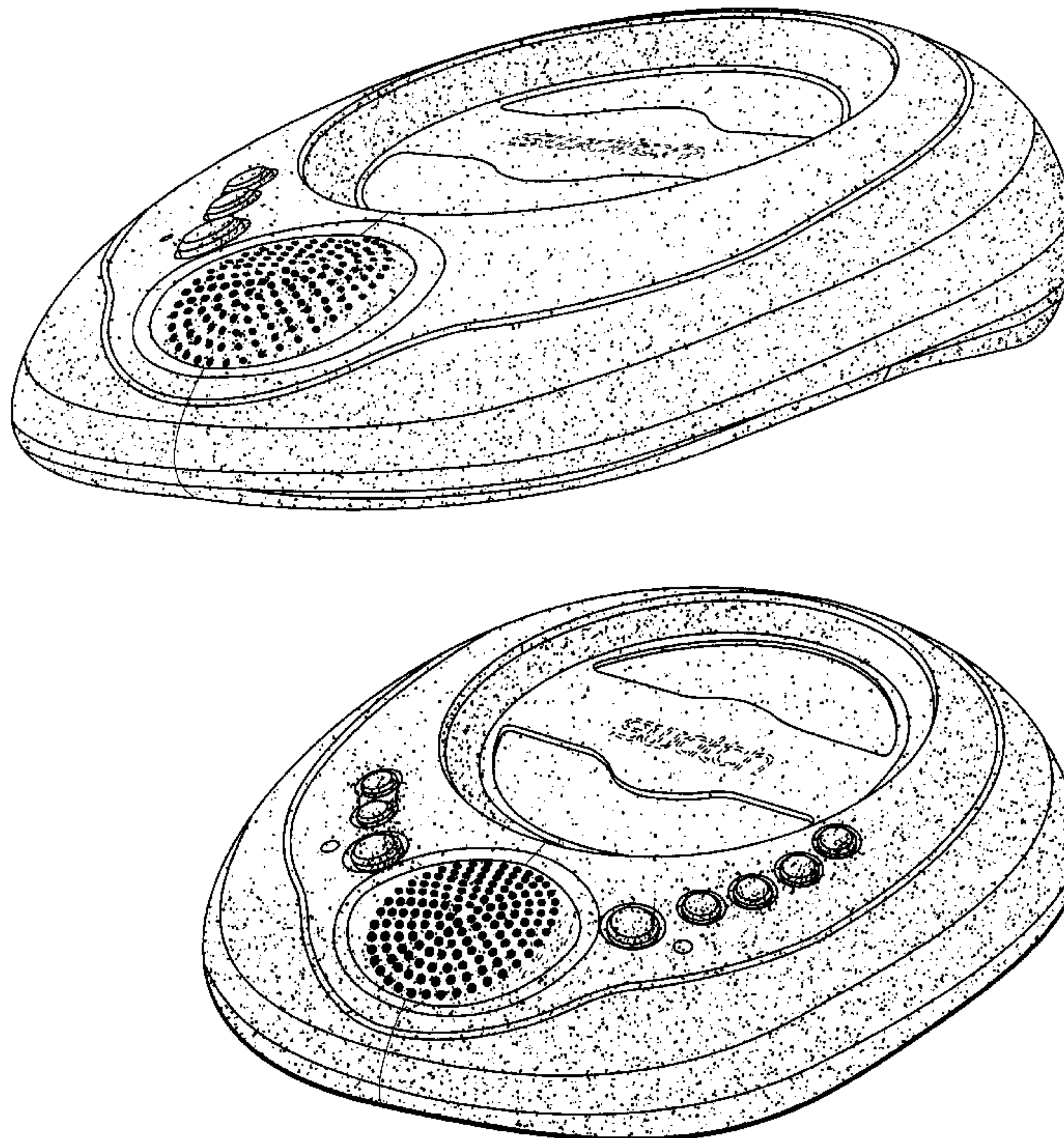

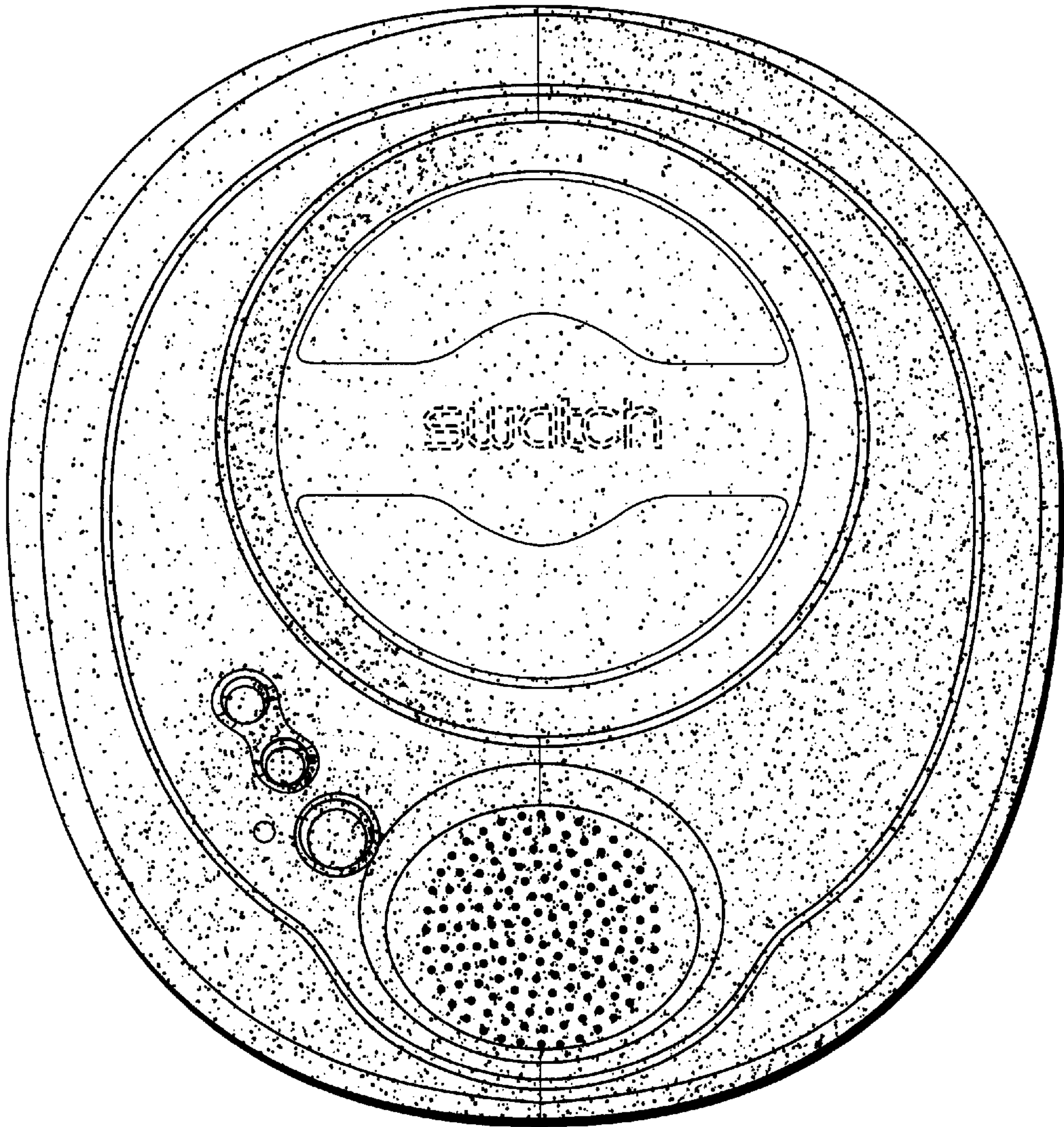

Fig. 1

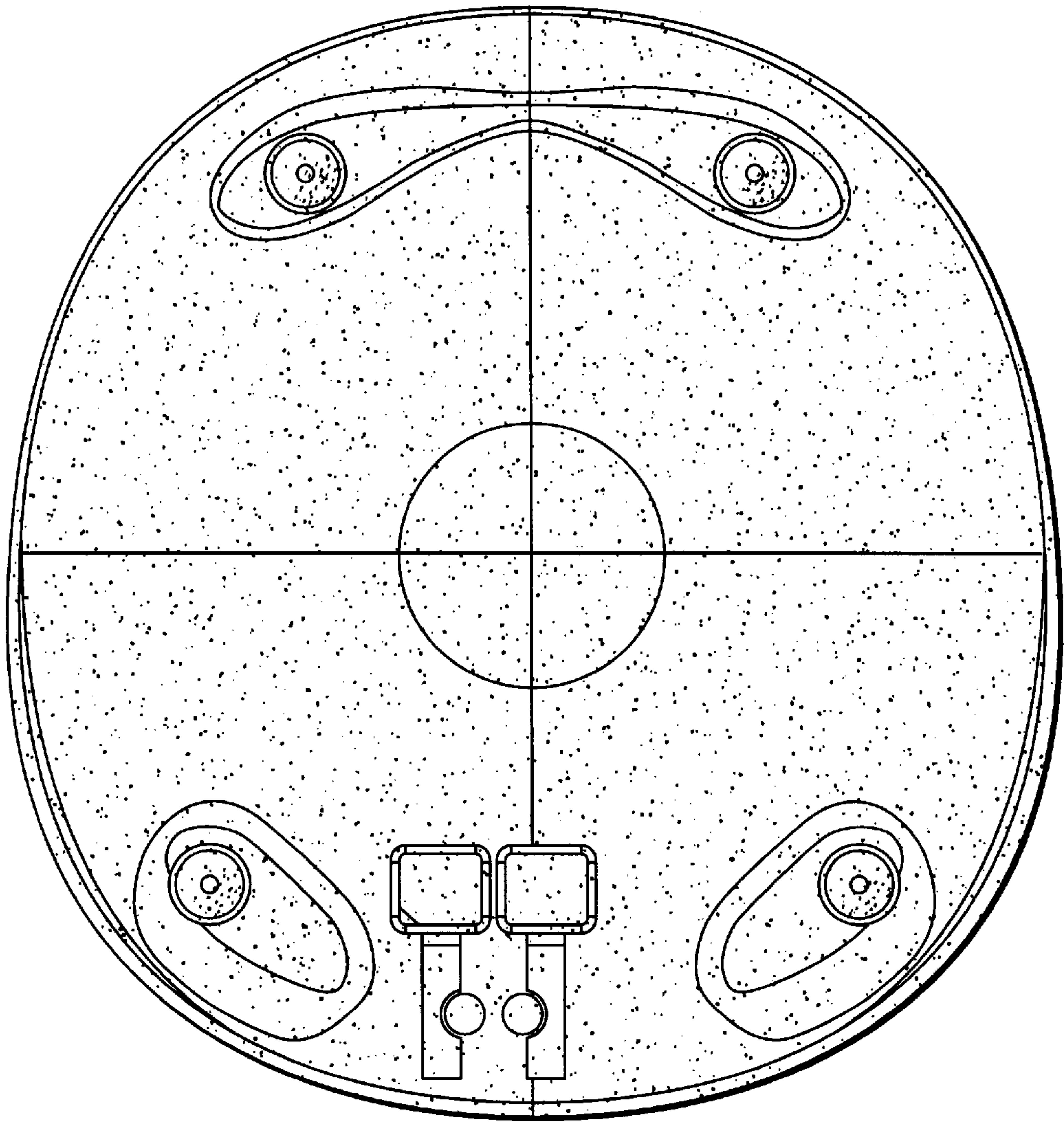

Fig. 2

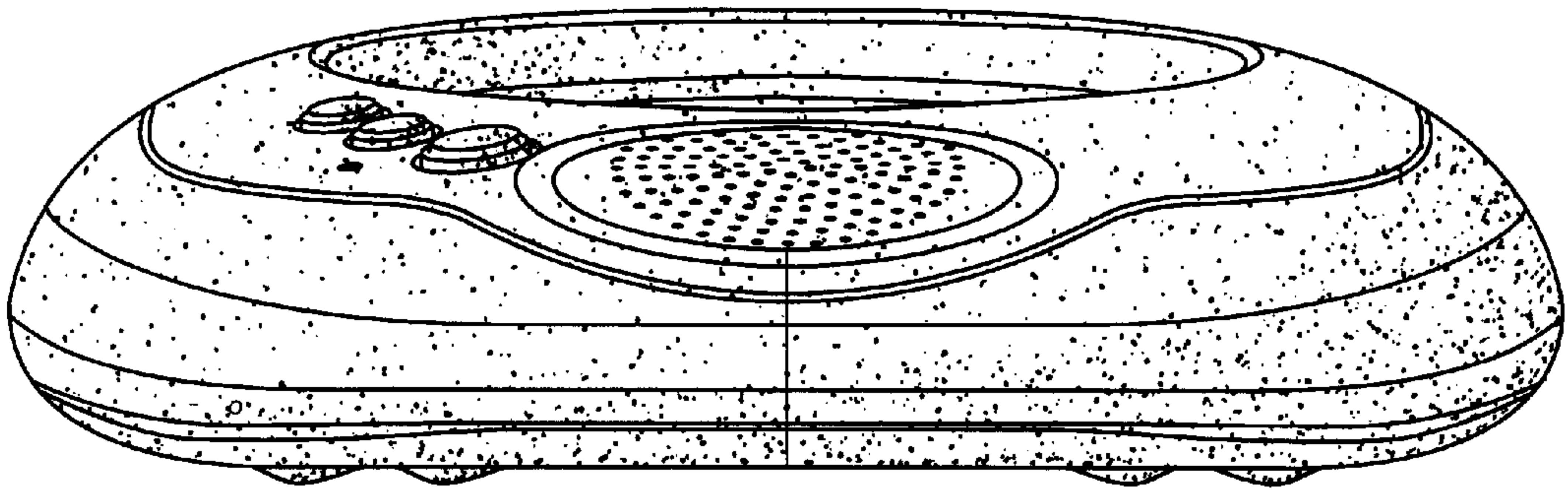

Fig. 3

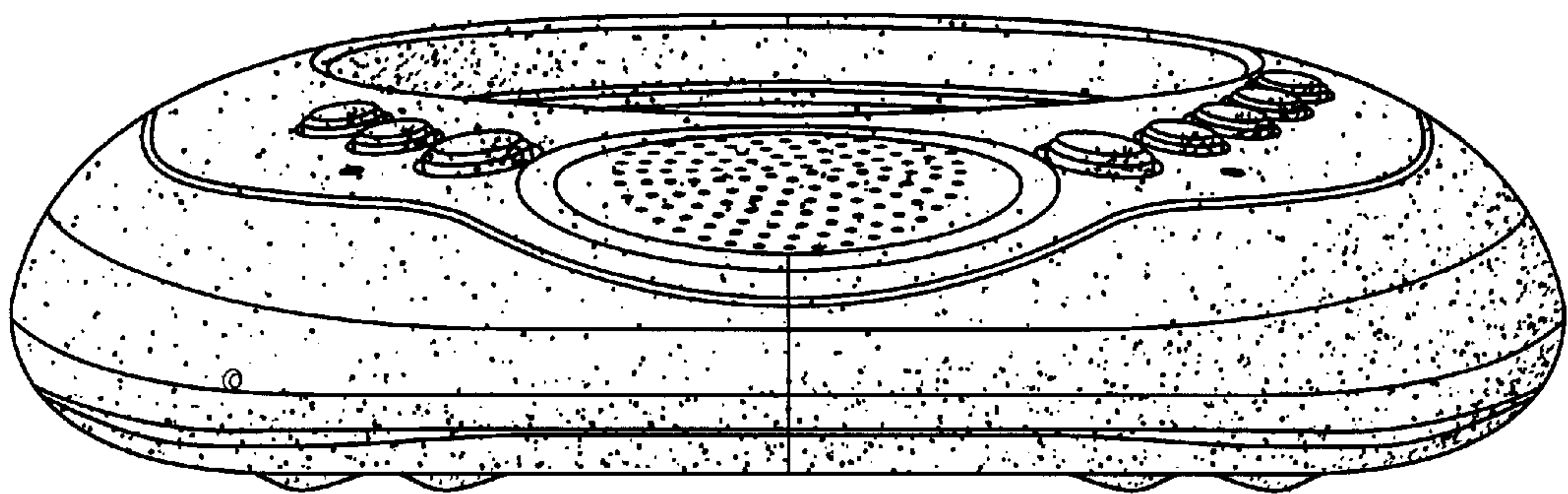

Fig. 10

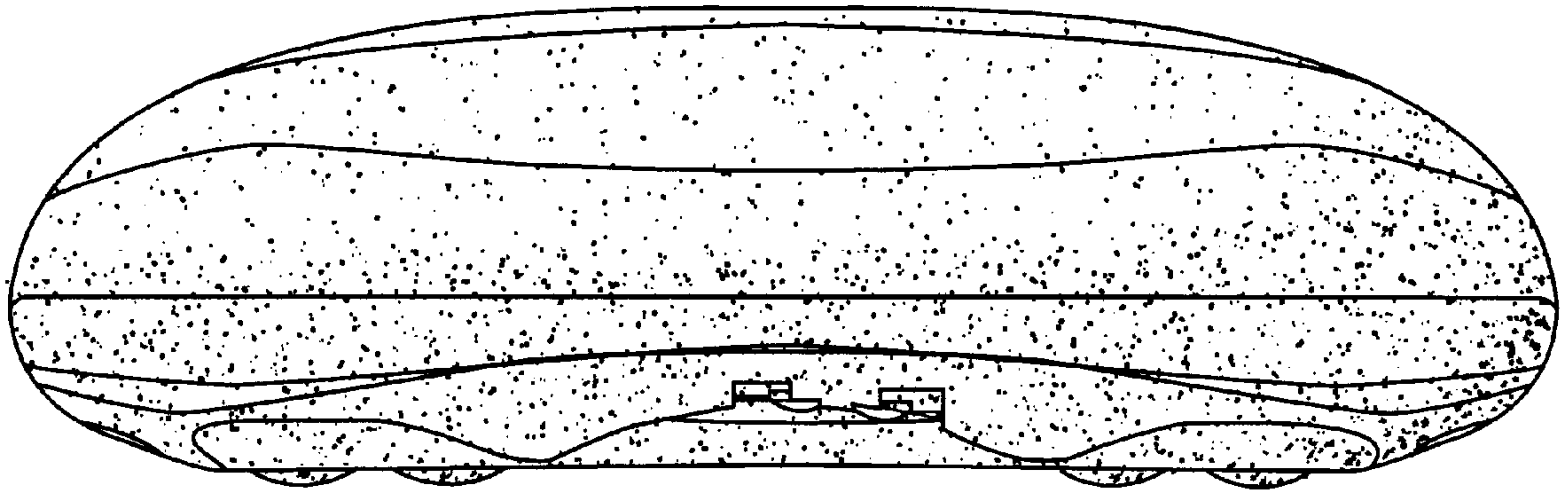

Fig. 11

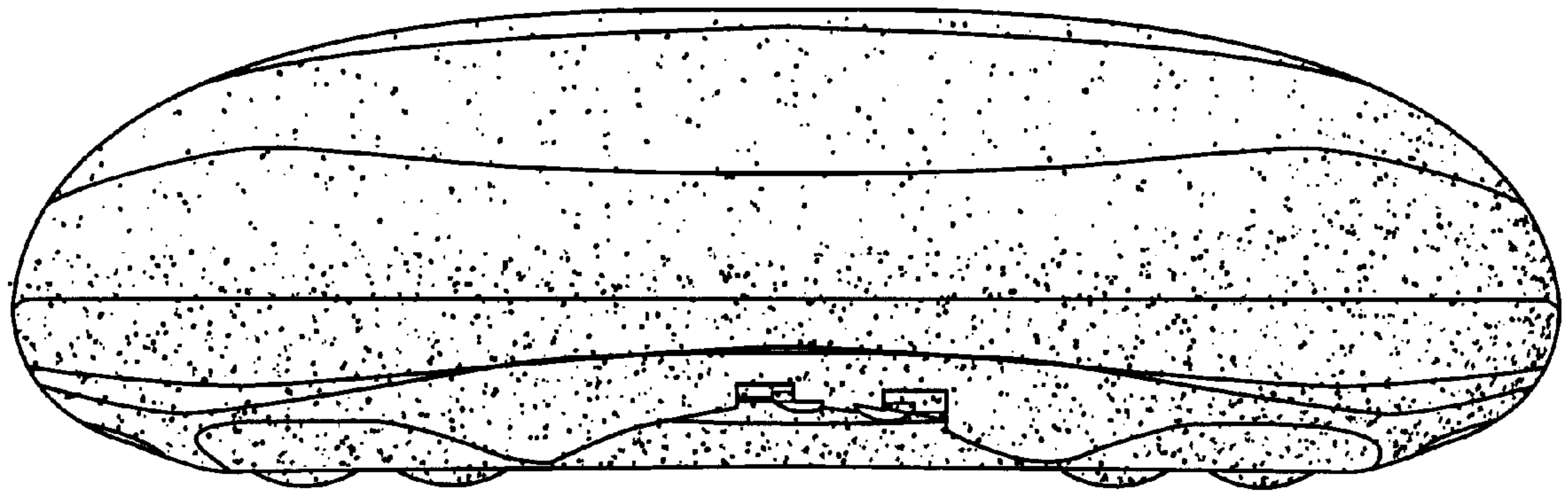

Fig. 4

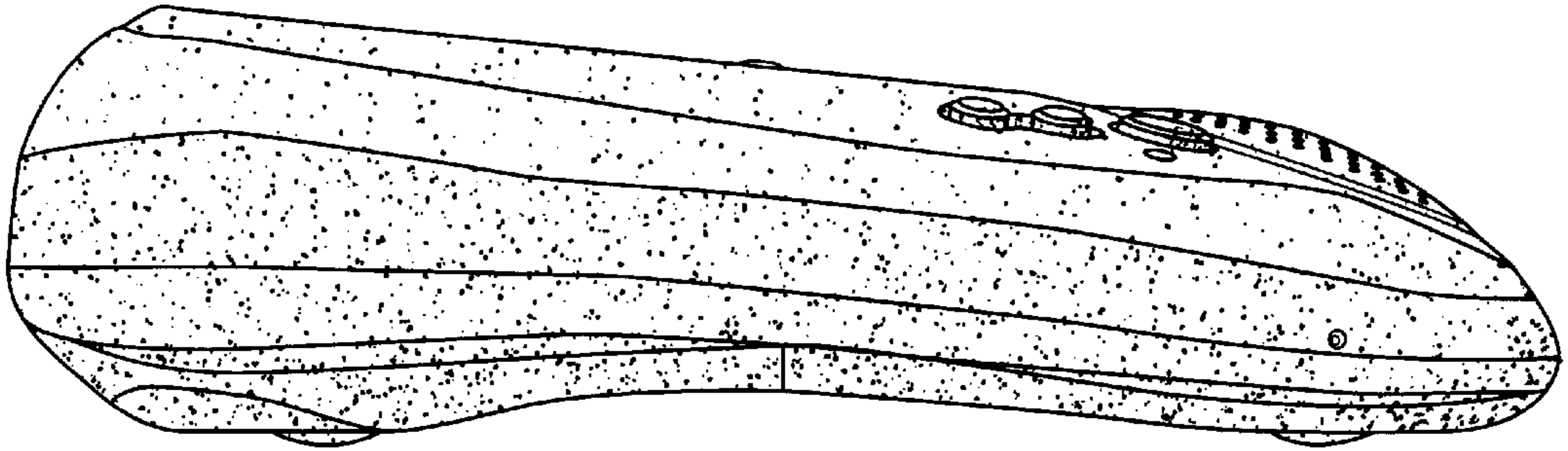

Fig. 12

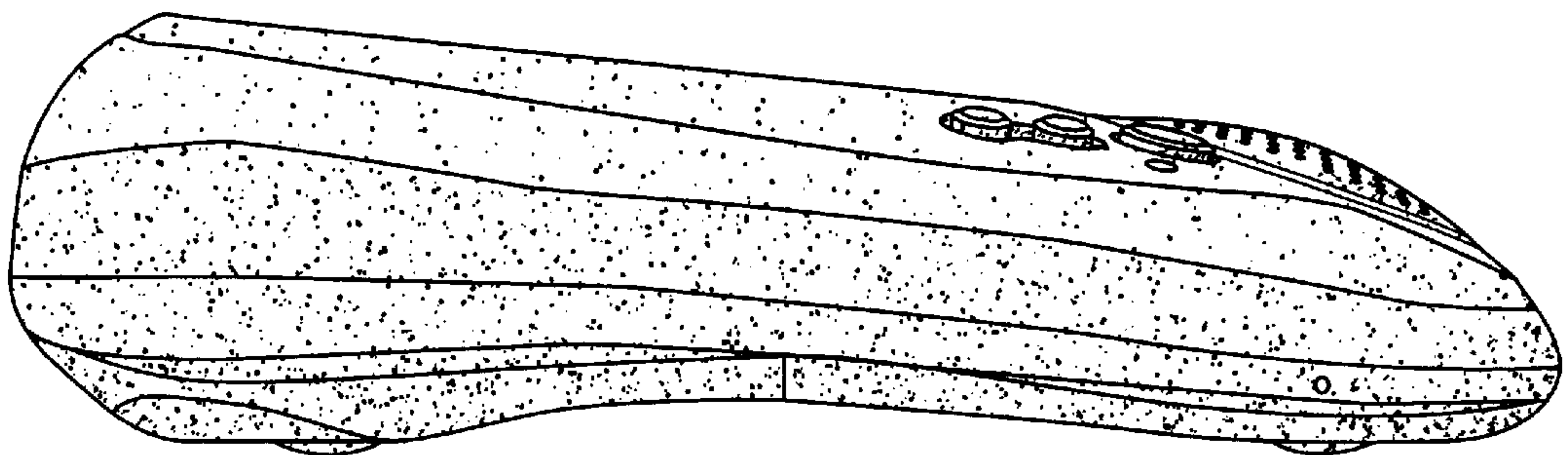

Fig. 5

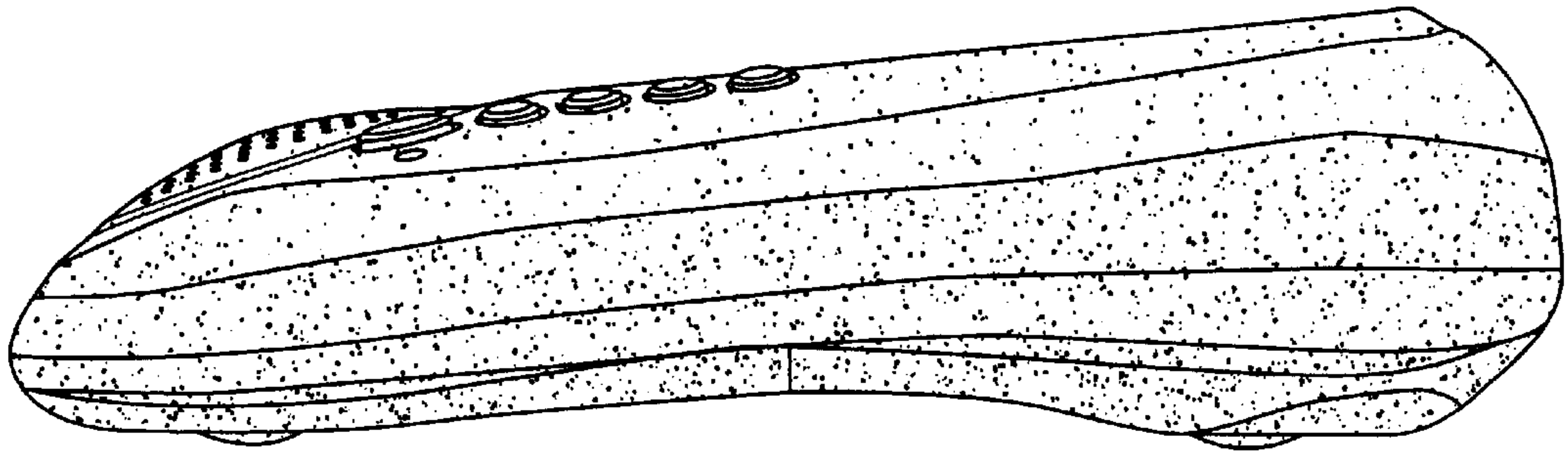

Fig. 13

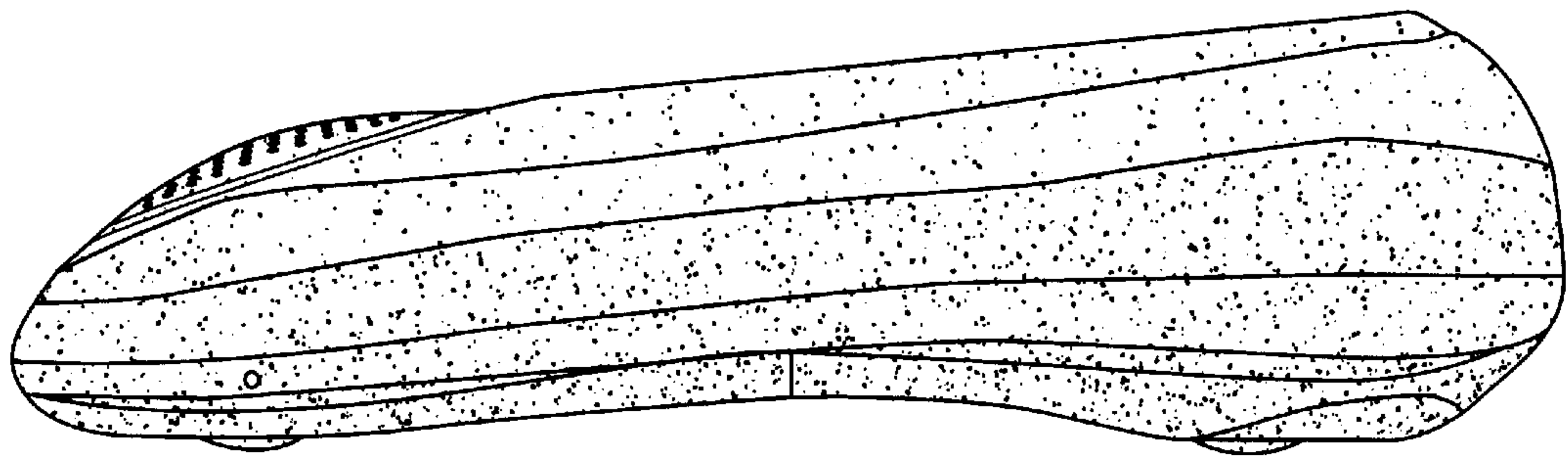

Fig. 6

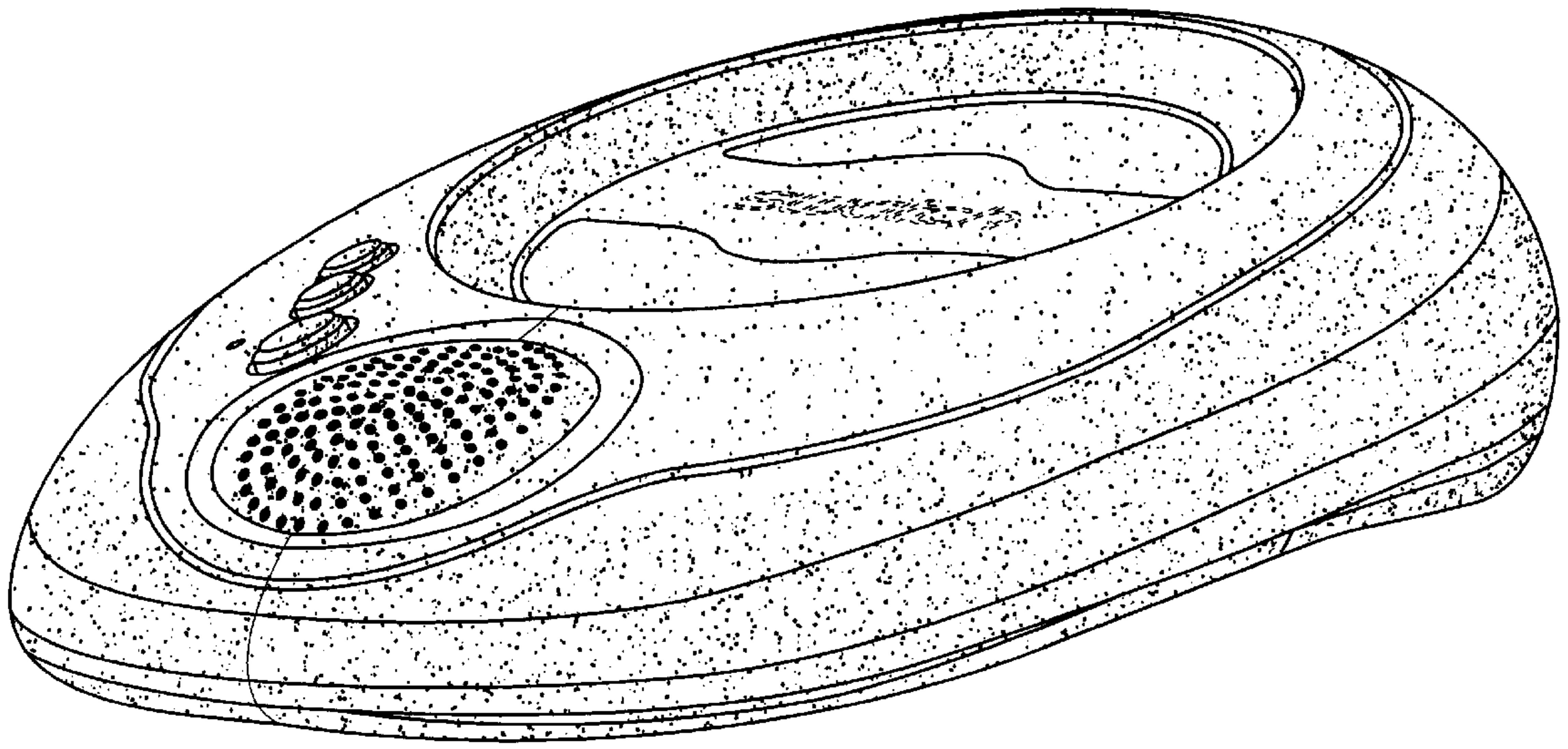

Fig. 7

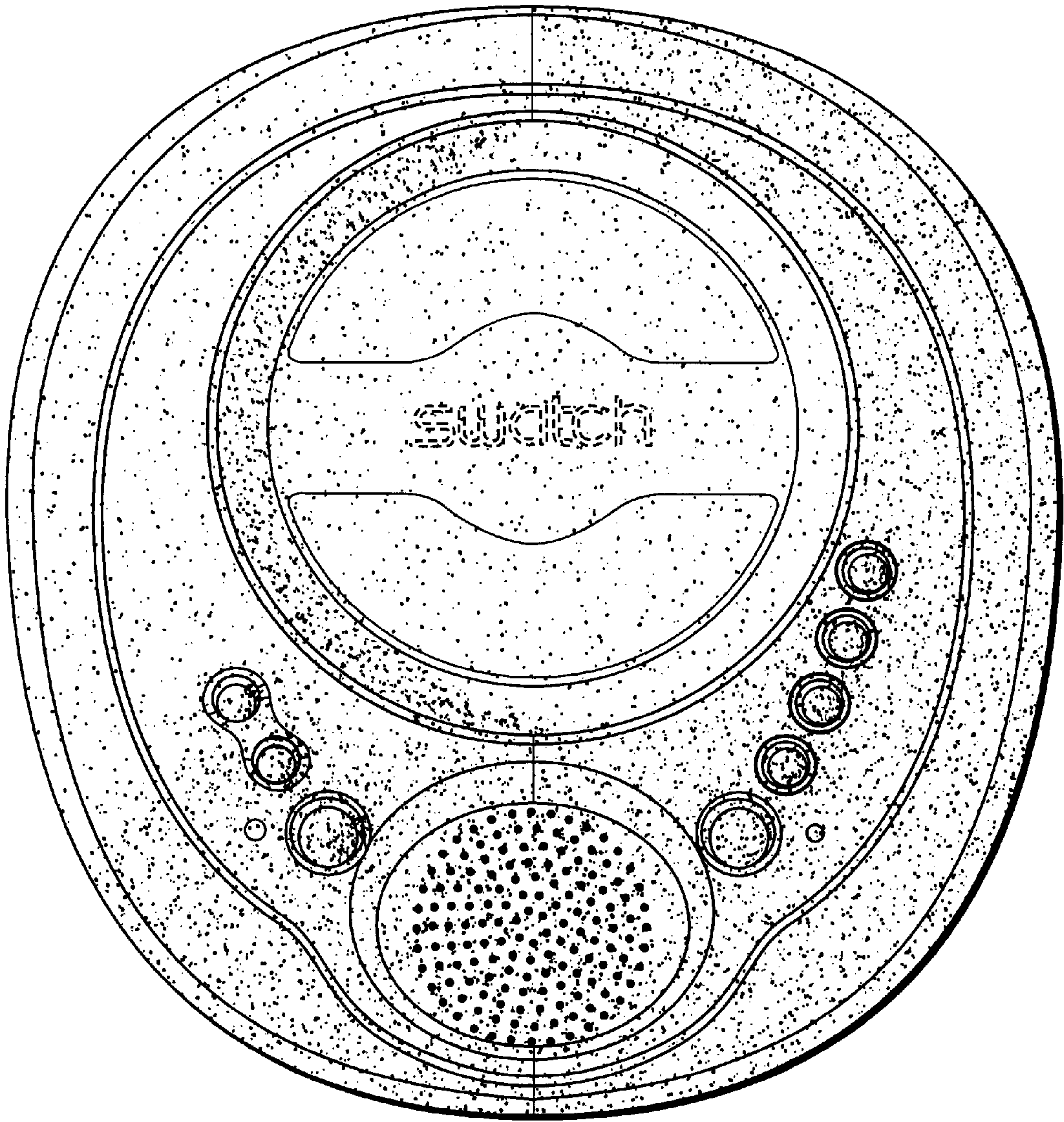

Fig. 8

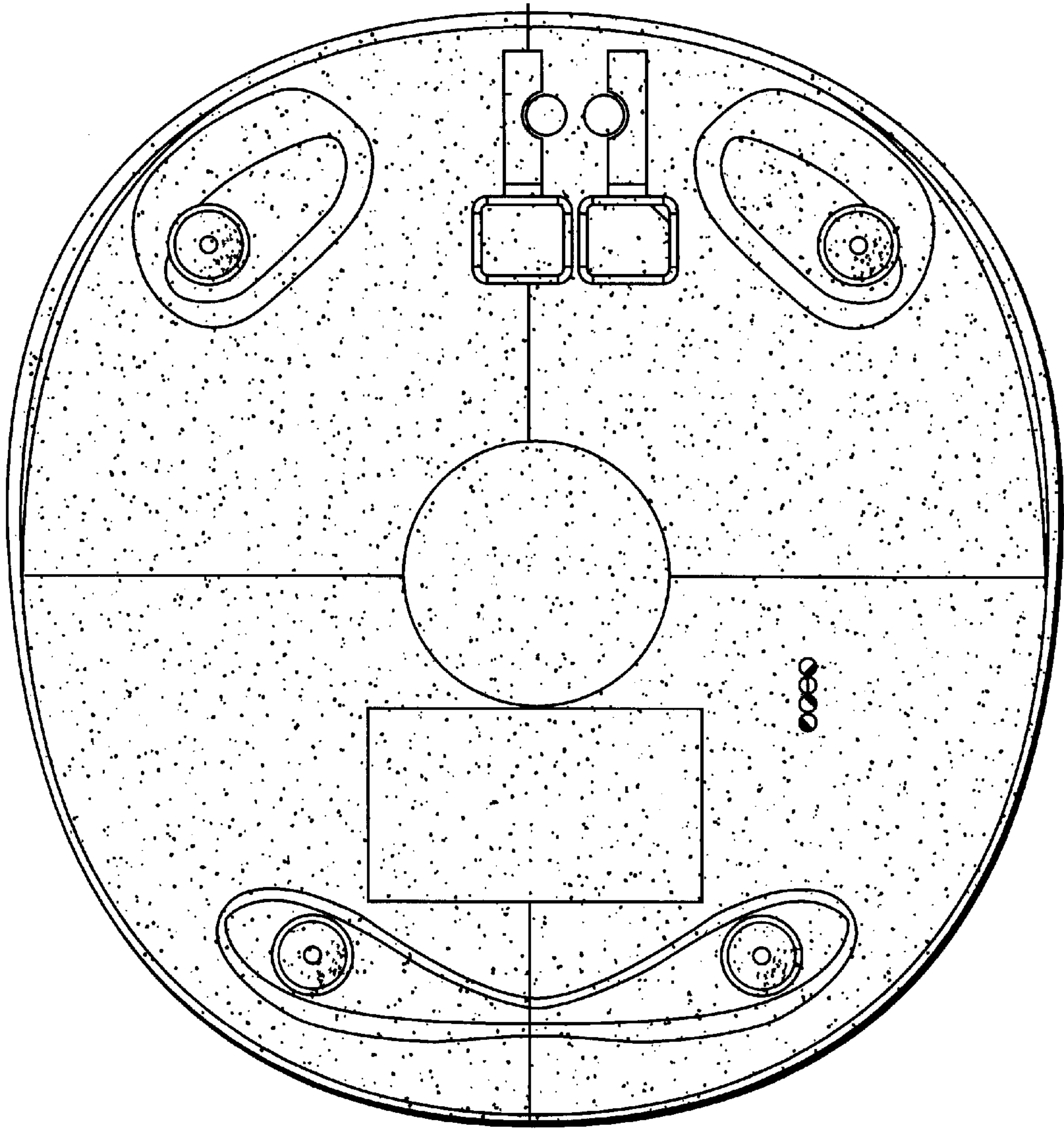

Fig. 9

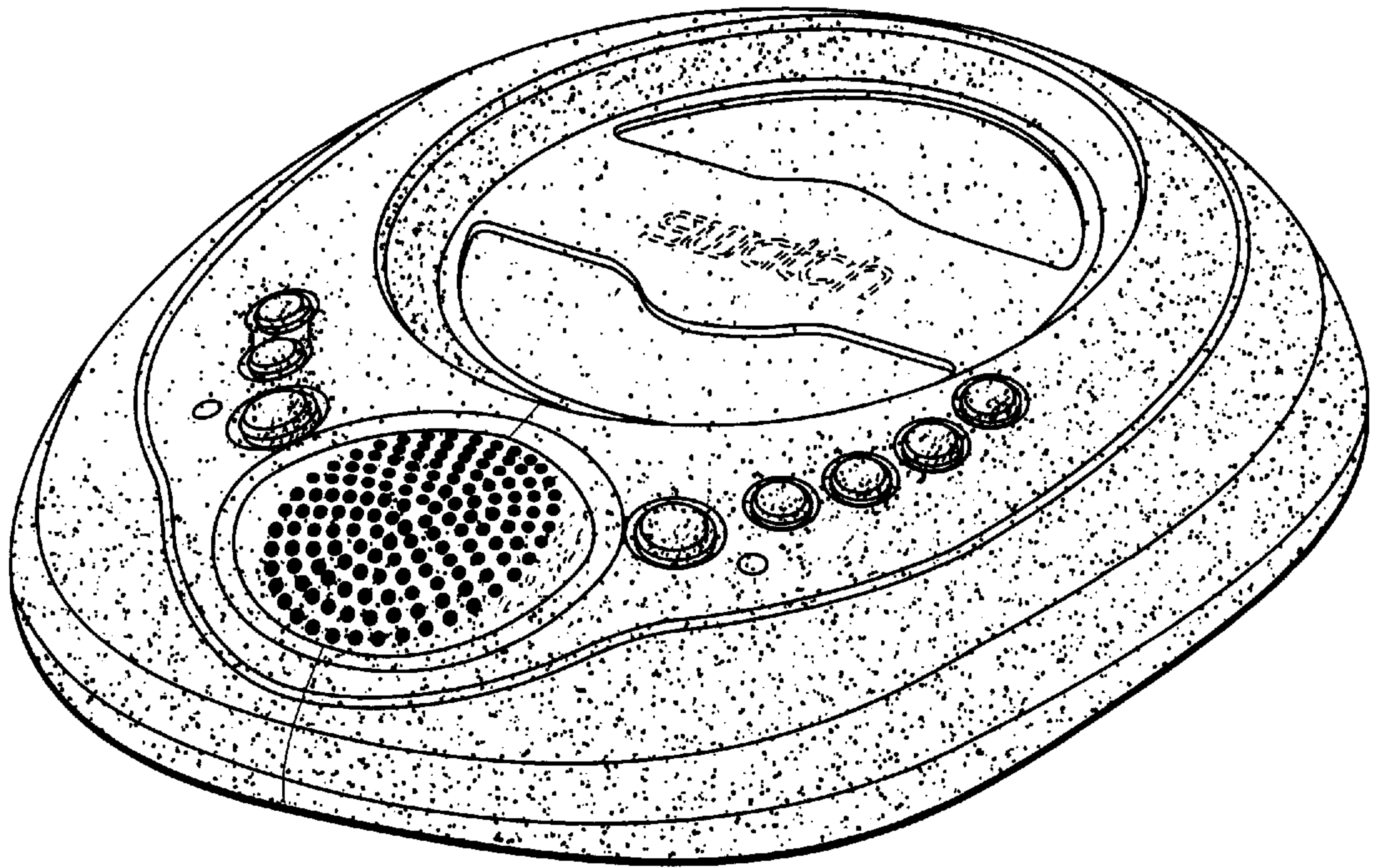

Fig. 14