



US00D426458S

United States Patent [19]

Axelsson

[11] **Patent Number: Des. 426,458**

[45] **Date of Patent: ** Jun. 13, 2000**

[54] **STRAP FASTENER**

[75] Inventor: **Lennart C. Axelsson**, Tinley Park, Ill.

[73] Assignee: **Panduit Corp.**, Tinley Park, Ill.

[**] Term: **14 Years**

[21] Appl. No.: **29/103,940**

[22] Filed: **Apr. 23, 1999**

[51] **LOC (7) Cl.** **08-08**

[52] **U.S. Cl.** **D8/394; D8/396**

[58] **Field of Search** D8/394-396, 382;
D2/637; 24/16 R, 16 PB, 20 R, 21, 22,
23 R, 23 B

[56] **References Cited**

U.S. PATENT DOCUMENTS

| | | |
|-----------|---------|--------------------|
| 362,376 | 5/1887 | Gould et al. . |
| 1,118,395 | 11/1914 | Campbell . |
| 1,173,998 | 2/1916 | Depew . |
| 1,178,398 | 4/1916 | Holmes . |
| 1,592,479 | 7/1926 | Williams . |
| 1,700,451 | 1/1929 | Ronci . |
| 1,705,895 | 3/1929 | Blair . |
| 2,012,543 | 8/1935 | Nolan . |
| 3,082,498 | 3/1963 | Oetiker . |
| 3,087,221 | 4/1963 | Armstrong . |
| 3,189,961 | 6/1965 | Heller . |
| 3,283,378 | 11/1966 | Cramton . |
| 3,402,436 | 11/1968 | Oetiker . |
| 3,577,601 | 5/1971 | Mariani . |
| 3,909,884 | 10/1975 | Weckesser . |
| 3,934,918 | 1/1976 | Kress et al. . |
| 4,235,404 | 11/1980 | Kraus . |
| 4,308,648 | 1/1982 | Fay . |
| 4,366,602 | 1/1983 | Conlon et al. . |
| 4,402,113 | 9/1983 | Smith . |
| 4,518,297 | 5/1985 | Kraus . |
| 4,638,531 | 1/1987 | Ribrant . |
| 4,843,686 | 7/1989 | Bartholomew . |
| 4,907,319 | 3/1990 | Calmettes et al. . |
| 4,919,682 | 4/1990 | Bellazzi . |
| 4,987,652 | 1/1991 | Spaulding . |
| 5,028,021 | 7/1991 | Sugiyama et al. . |
| 5,111,555 | 5/1992 | Oetiker . |
| 5,117,536 | 6/1992 | Beach et al. . |
| 5,144,726 | 9/1992 | Calmettes et al. . |

| | | |
|-----------|---------|------------|
| 5,230,126 | 7/1993 | Oetiker . |
| 5,307,541 | 5/1994 | Nagano . |
| 5,353,478 | 10/1994 | Spors . |
| 5,395,343 | 3/1995 | Iscovich . |
| 5,548,876 | 8/1996 | Oetiker . |
| 5,706,558 | 1/1998 | Sauer . |

FOREIGN PATENT DOCUMENTS

| | | |
|---------|---------|-----------|
| 1116743 | 5/1956 | France . |
| 1138688 | 1/1963 | France . |
| 487202 | 12/1929 | Germany . |

Primary Examiner—B. J. Bullock
Attorney, Agent, or Firm—Robert A. McCann

[57] **CLAIM**

The ornamental design for a strap fastener, as shown and described.

DESCRIPTION

FIG. 1 is a top left perspective view of a strap fastener; FIG. 2 is a top right perspective view of the strap fastener of FIG. 1; FIG. 3 is a bottom rear left perspective view of the strap fastener of FIG. 1; FIG. 4 is an enlarged left side view of the strap fastener of FIG. 1; FIG. 5 is an enlarged right side view of the strap fastener of FIG. 1; FIG. 6 is an enlarged top view of the strap fastener of FIG. 1; FIG. 7 is an enlarged bottom view of the strap fastener of FIG. 1; FIG. 8 is an enlarged front view of the strap fastener of FIG. 1; FIG. 9 is an enlarged rear view of the strap fastener of FIG. 1; and, FIG. 10 is an enlarged sectional view taken along line 10—10 of the corrugated portion of the strap fastener of FIG. 1.

The broken lines in FIGS. 1-9 are for illustrative purposes only and form no part of the claimed design. The portion of the strap adjacent the angled end is shown broken away to indicate indeterminate length while the portion of the strap adjacent the locking head is shown broken away in FIGS. 4-7 for ease of illustration.

1 Claim, 3 Drawing Sheets

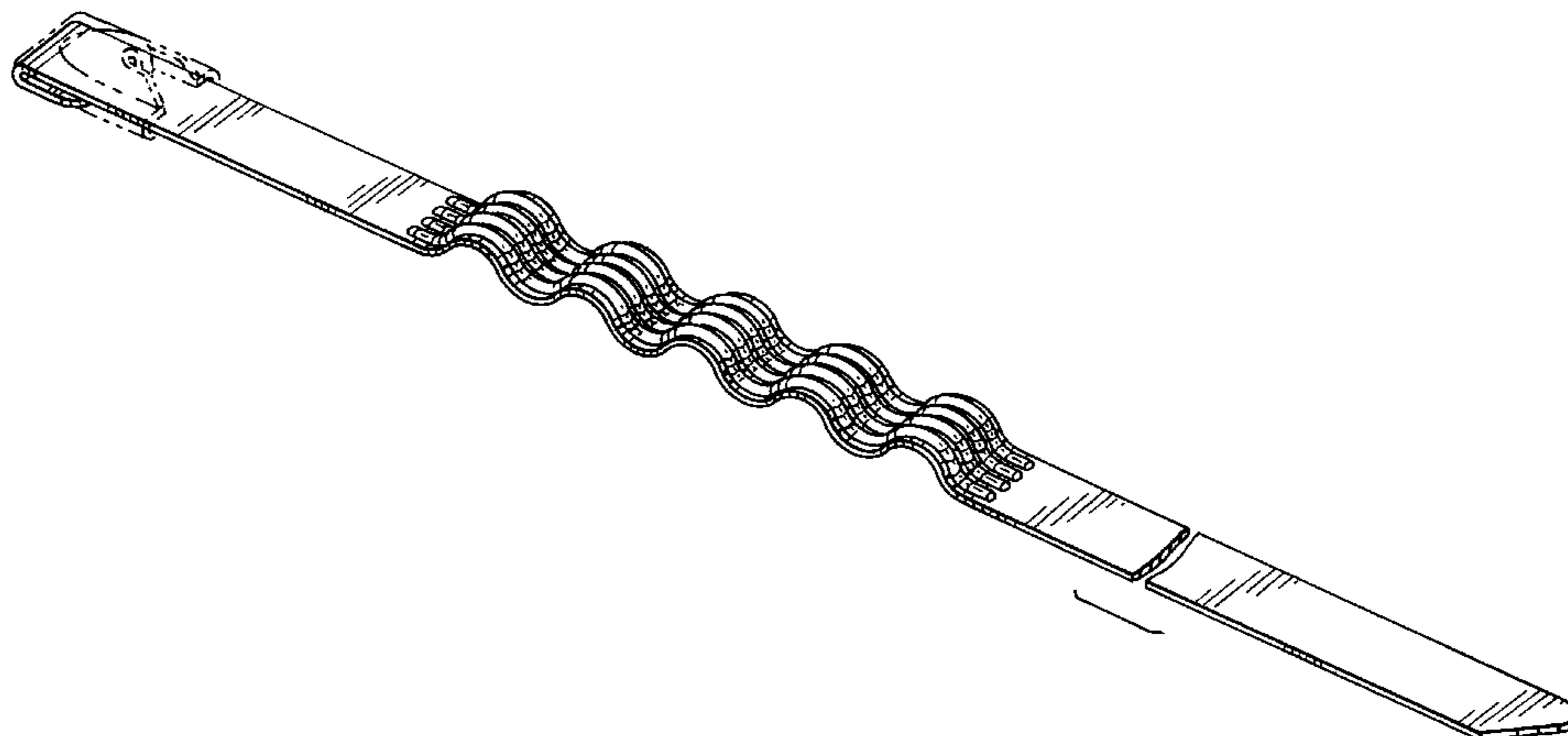

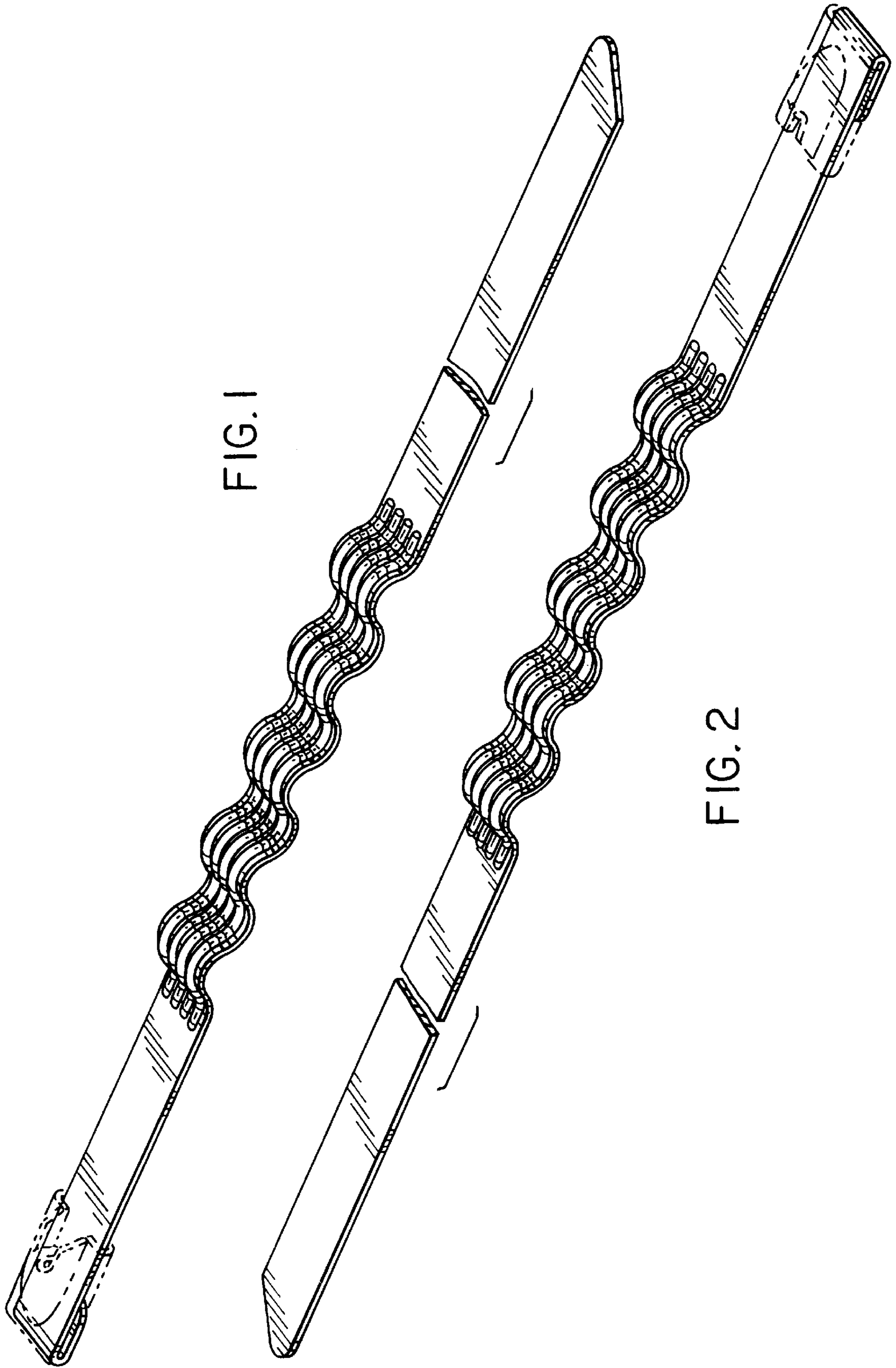

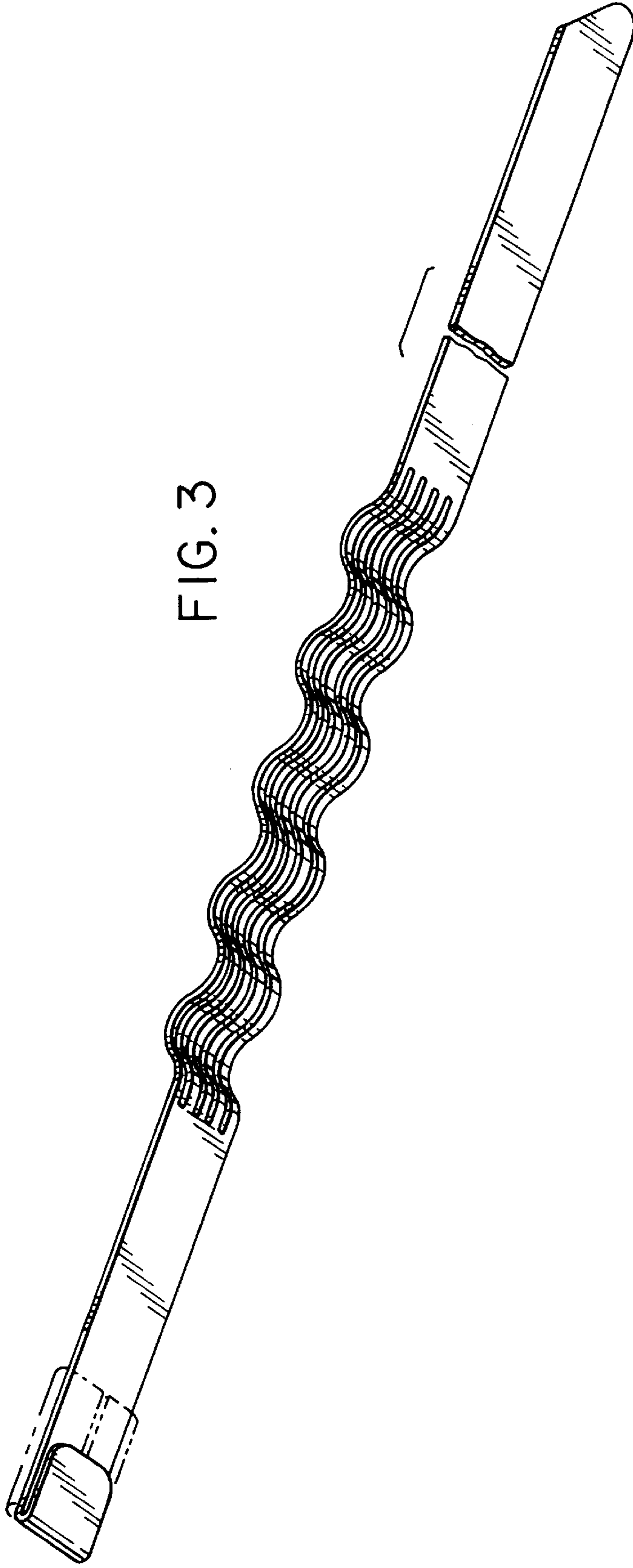

FIG. 3

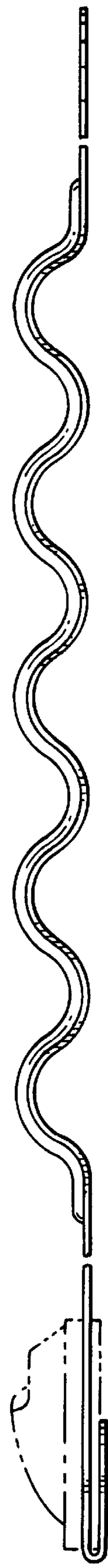

FIG. 4



FIG. 5

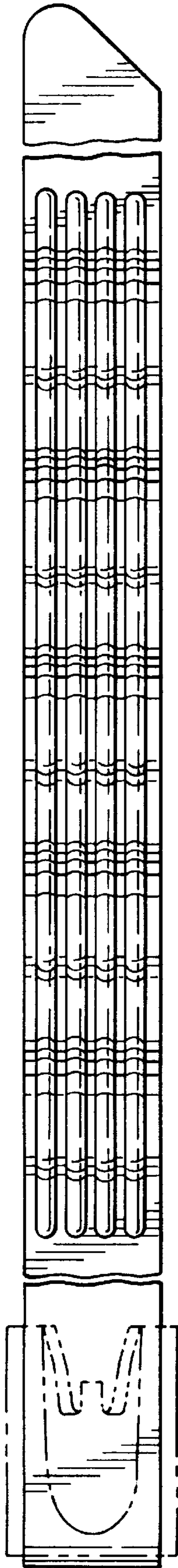

FIG. 6

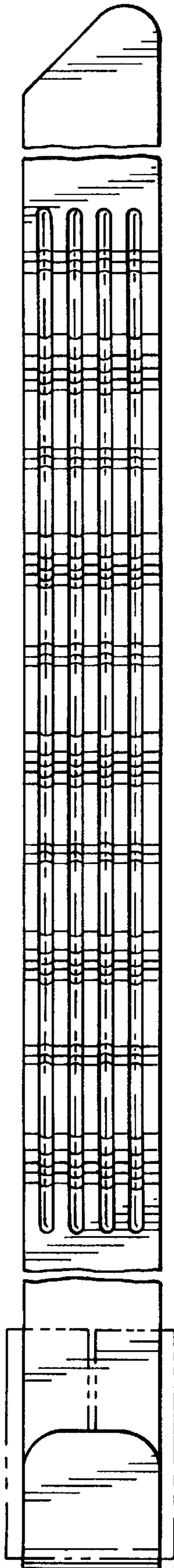

FIG. 7

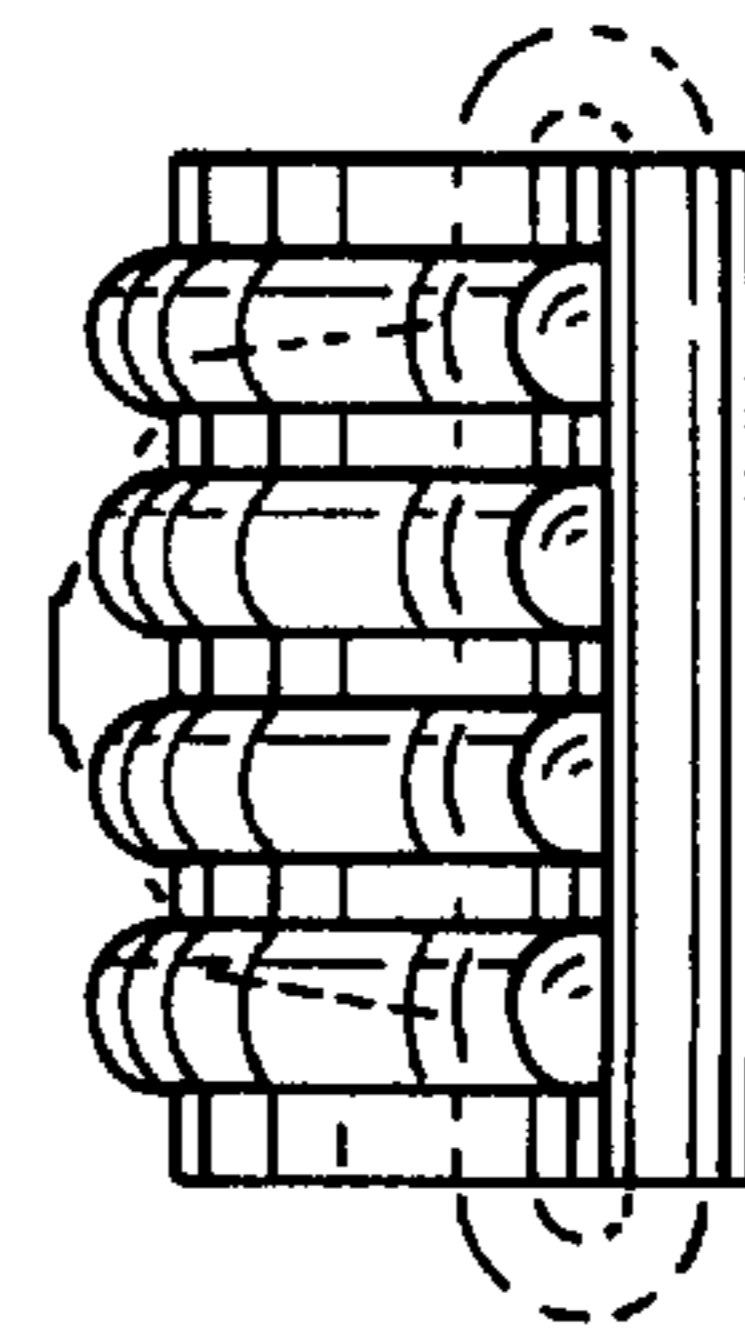

FIG. 8

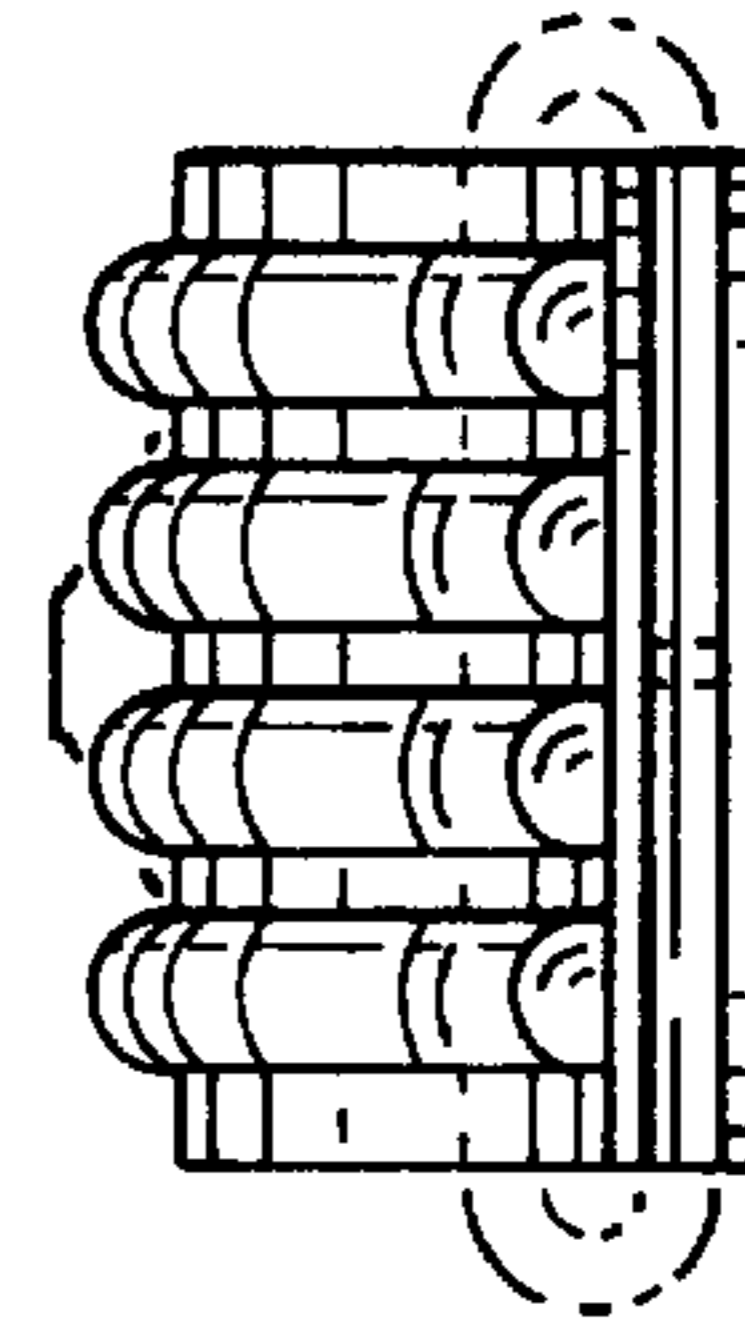

FIG. 9

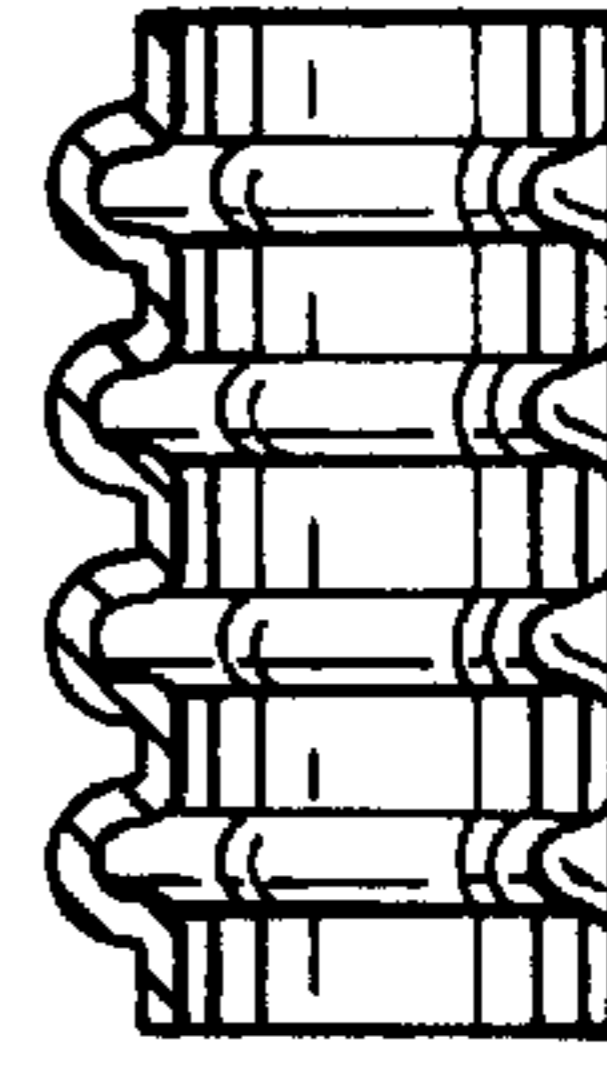

FIG. 10