



US00D426293S

United States Patent [19]

Tounsi et al.

[11] Patent Number: Des. 426,293

[45] Date of Patent: ** Jun. 6, 2000

[54] AIR CLEANER

[75] Inventors: **Madjid Tounsi**, Quebec; **D. Barry Huehn**, Point Claire, both of Canada; **Kent Williams**, Clinton, Mo.; **Philip Frank**, Portland, Oreg.; **Omer Kotzer**, Portland, Oreg.; **Kim Porter**, Portland, Oreg.; **Sohrab Vossoughi**, Portland, Oreg.; **Scott Thorpe**, Portland, Oreg.; **Steve McCallion**, Portland, Oreg.; **Angelika Schubert-Belle**, Portland, Oreg.

[73] Assignee: **The Rival Company**, Kansas City, Mo.

[**] Term: **14 Years**

[21] Appl. No.: **29/093,382**

[22] Filed: **Sep. 9, 1998**

[51] LOC (7) Cl. **23-04**

[52] U.S. Cl. **D23/364**

[58] Field of Search D23/364, 355, D23/365, 332, 335, 370, 381; 96/97; 55/356; 422/122, 120

[56] References Cited

U.S. PATENT DOCUMENTS

- D. 119,197 2/1940 MacFadden et al. .
- D. 173,550 11/1954 Wrablica .
- D. 267,424 12/1982 Boldt et al. .
- D. 272,646 2/1984 Tsuji et al. .
- D. 274,645 7/1984 Grube .
- D. 281,618 12/1985 Grube .
- D. 282,869 3/1986 Parnell .
- D. 290,498 6/1987 Beane et al. .
- D. 290,997 7/1987 Utsuki et al. .
- D. 291,350 8/1987 Sherman et al. .
- D. 294,633 3/1988 McBratney .
- D. 300,353 3/1989 Yurkovic .
- D. 300,847 4/1989 Lin .
- D. 305,260 12/1989 Mito .
- D. 309,182 7/1990 Hsu .
- D. 311,951 11/1990 Dubin .
- D. 312,124 11/1990 Coup et al. .
- D. 313,069 12/1990 McCormick .
- D. 315,598 3/1991 Yamamoto et al. .

- D. 318,526 7/1991 Chaney .
- D. 323,708 2/1992 Wang .
- D. 324,907 3/1992 Cook .
- D. 325,251 4/1992 Schindler et al. .
- D. 329,284 9/1992 Patton .
- D. 337,635 7/1993 Schindler et al. .
- D. 343,448 1/1994 Jursich et al. .
- D. 343,677 1/1994 Gyori et al. .
- D. 353,661 12/1994 Cich, Jr. et al. .
- D. 354,557 1/1995 Cich, Jr. et al. .
- D. 402,746 12/1998 Clark et al. D23/364

(List continued on next page.)

FOREIGN PATENT DOCUMENTS

- 1193100 10/1959 France .
- 51-118258 9/1976 Japan .
- 61-208455 9/1986 Japan .
- 485282 12/1975 U.S.S.R. .
- 619760 2/1978 U.S.S.R. .

OTHER PUBLICATIONS

Grainger 1996 Catalog No. 387 (5 pages).
"These Models Cool or Heat the Air," Sun Radio Co. Adv. Brochure, inside page.
"A world of warmth . . . Arvin Portable Electric Heaters," Bell & Co. cat., 1960.

Primary Examiner—Lisa Lichtenstein
Attorney, Agent, or Firm—Brinks Hofer Gilson & Lione; Francis E. Marino

[57] CLAIM

The ornamental design for air cleaner, as shown and described.

DESCRIPTION

FIG. 1 is a perspective view of an air cleaner showing our new design;
FIG. 2 is a front view thereof;
FIG. 3 is a left side view thereof, which is similar to the right side view;
FIG. 4 is a top view thereof; and,
FIG. 5 is a rear view thereof.
The bottom side is plain and unornamented.

1 Claim, 5 Drawing Sheets

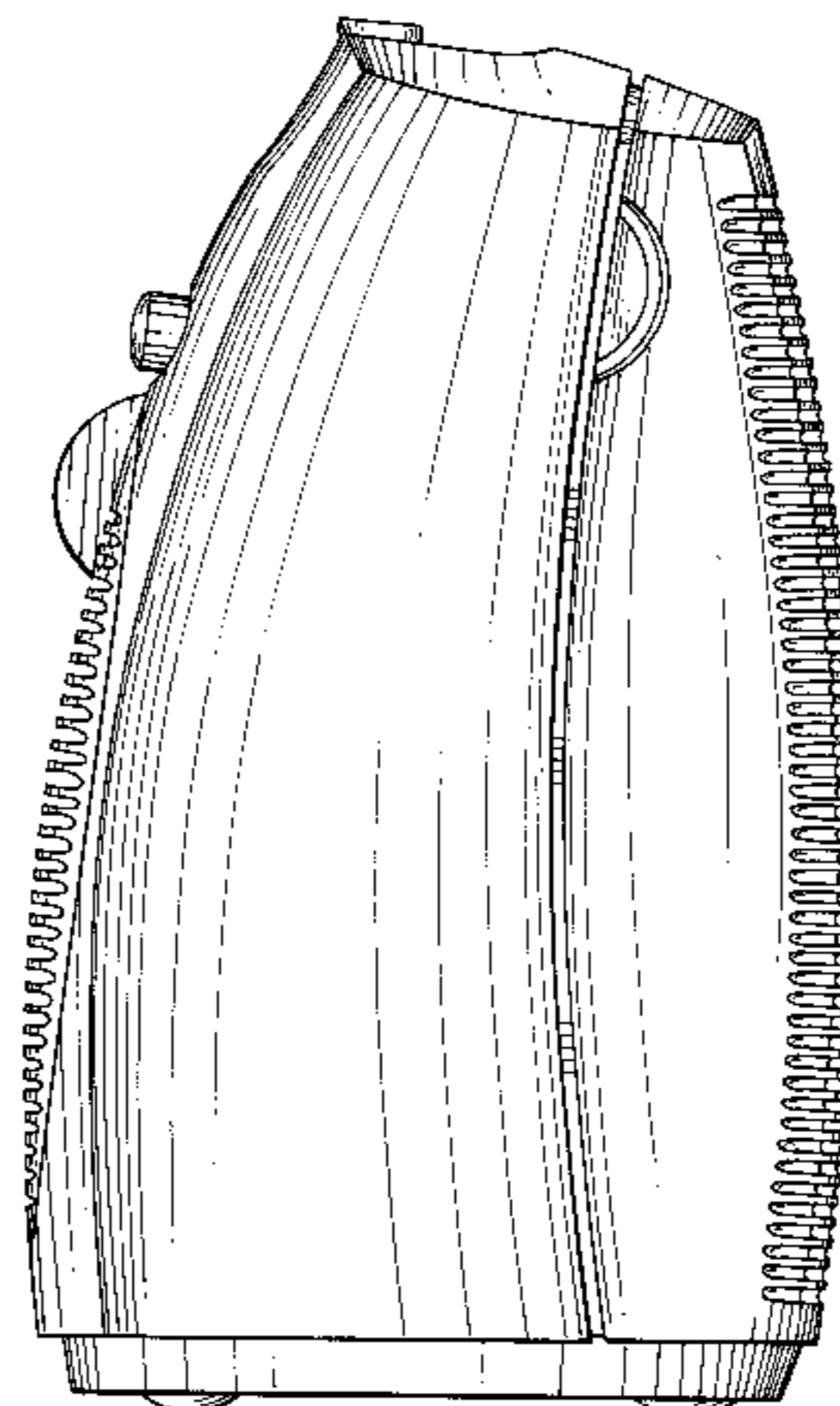
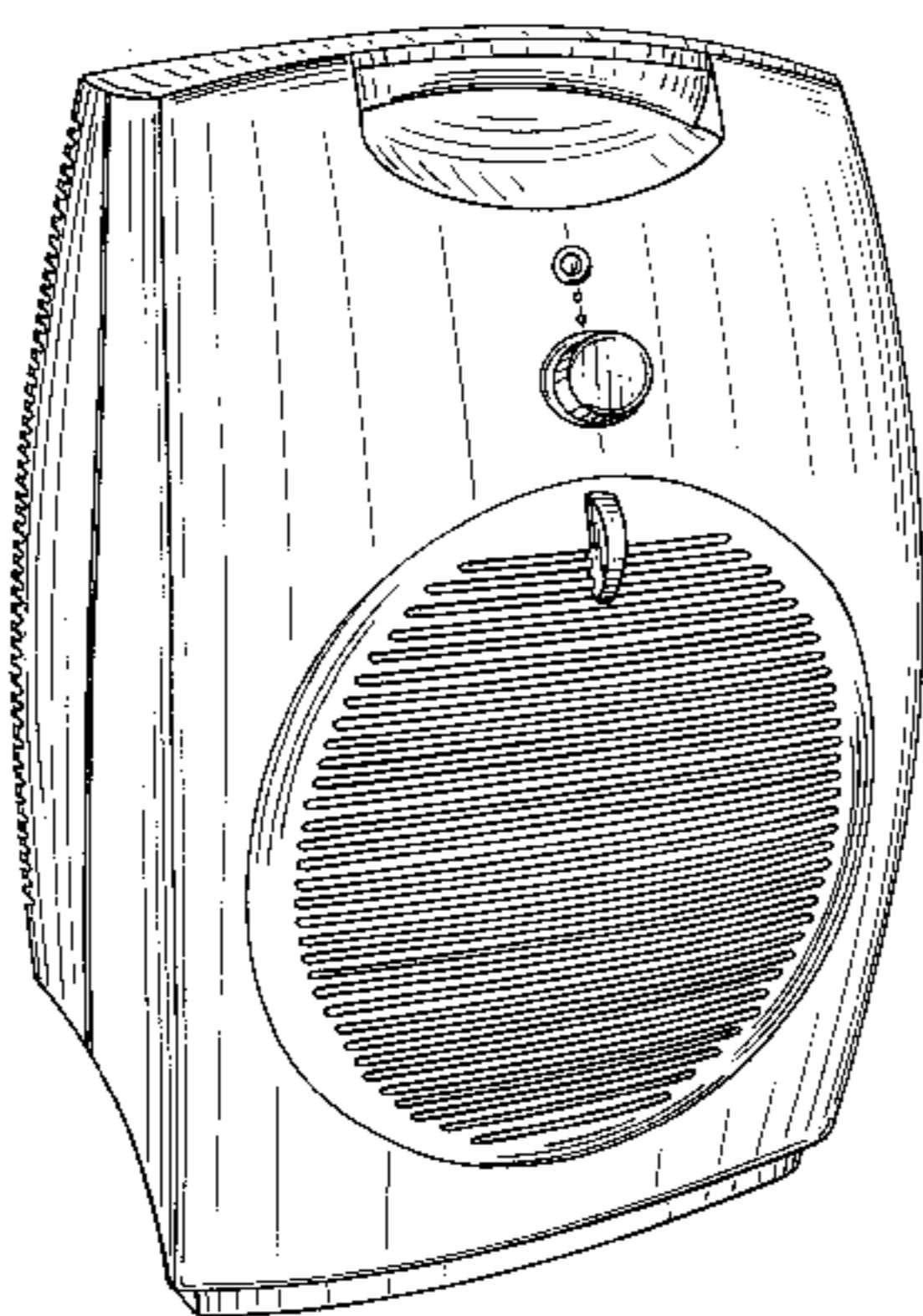

U.S. PATENT DOCUMENTS

1,952,269	3/1934	Lundquist .	3,348,822	10/1967	Viceli et al. .
2,100,439	11/1937	Friedman .	3,385,287	5/1968	Lawson et al. .
2,590,600	3/1952	Farr et al. .	3,637,981	1/1972	Swimmer .
2,707,745	5/1955	Farr et al. .	3,725,640	4/1973	Kunz .
2,766,027	10/1956	Herr .	3,914,349	10/1975	Stipanuk .
2,914,647	11/1959	Ganske et al. .	4,463,248	7/1984	Katzman et al. .
3,019,324	1/1962	Sohn .	4,686,069	8/1987	Hahne et al. .
3,348,821	10/1967	Martin et al. .	4,811,159	3/1989	Foster, Jr. .
			4,906,417	3/1990	Gentry .

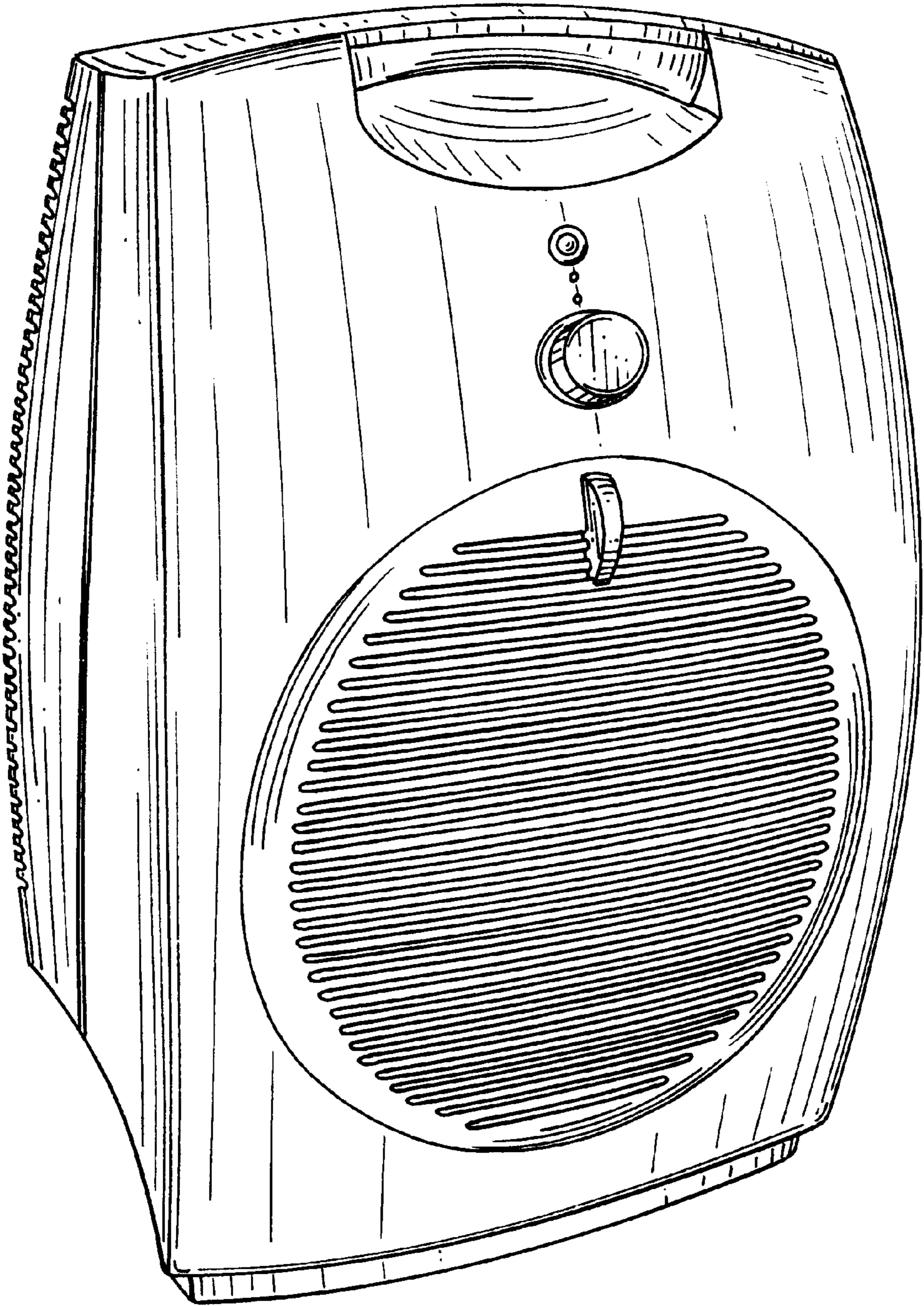

Fig. 1

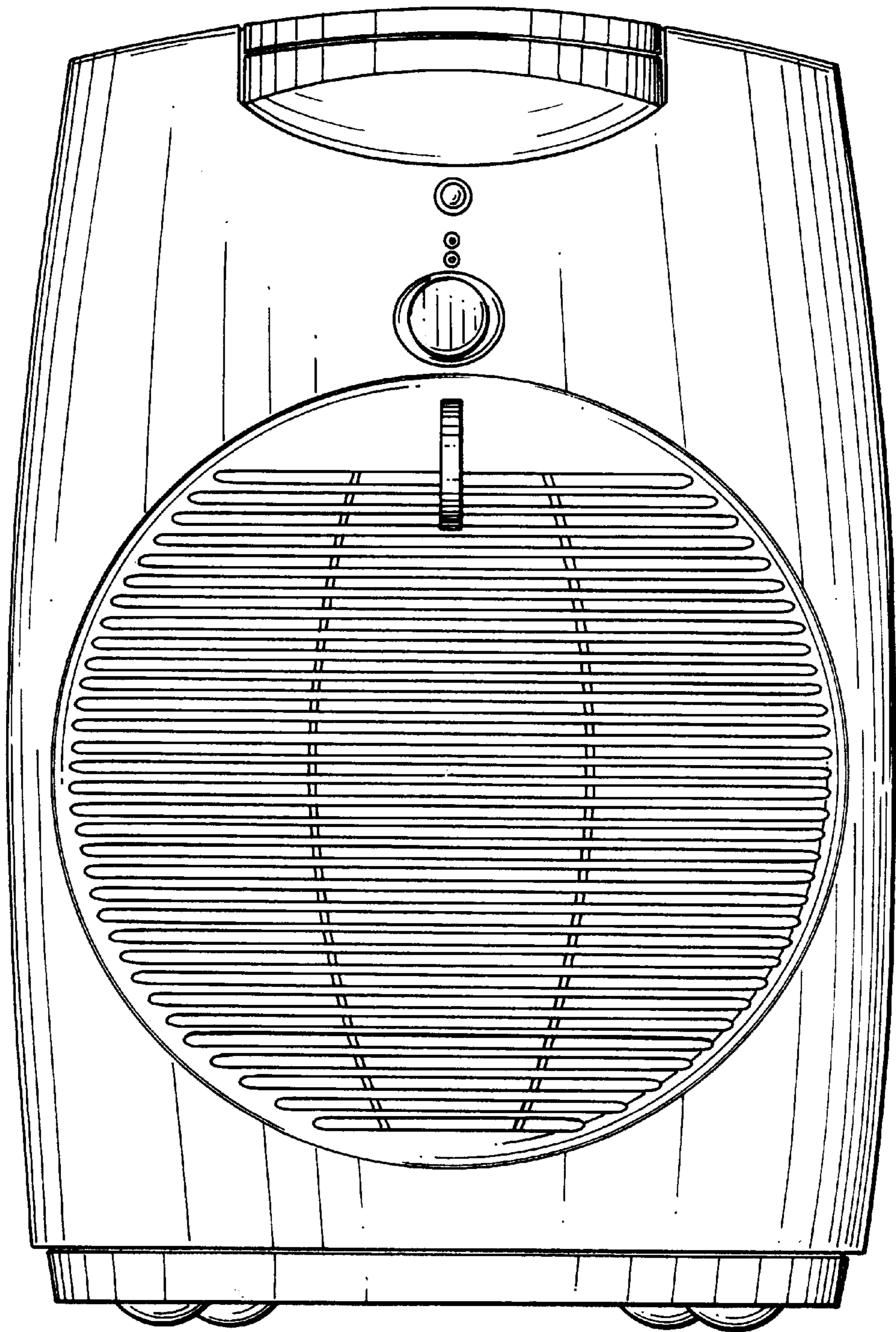

Fig. 2

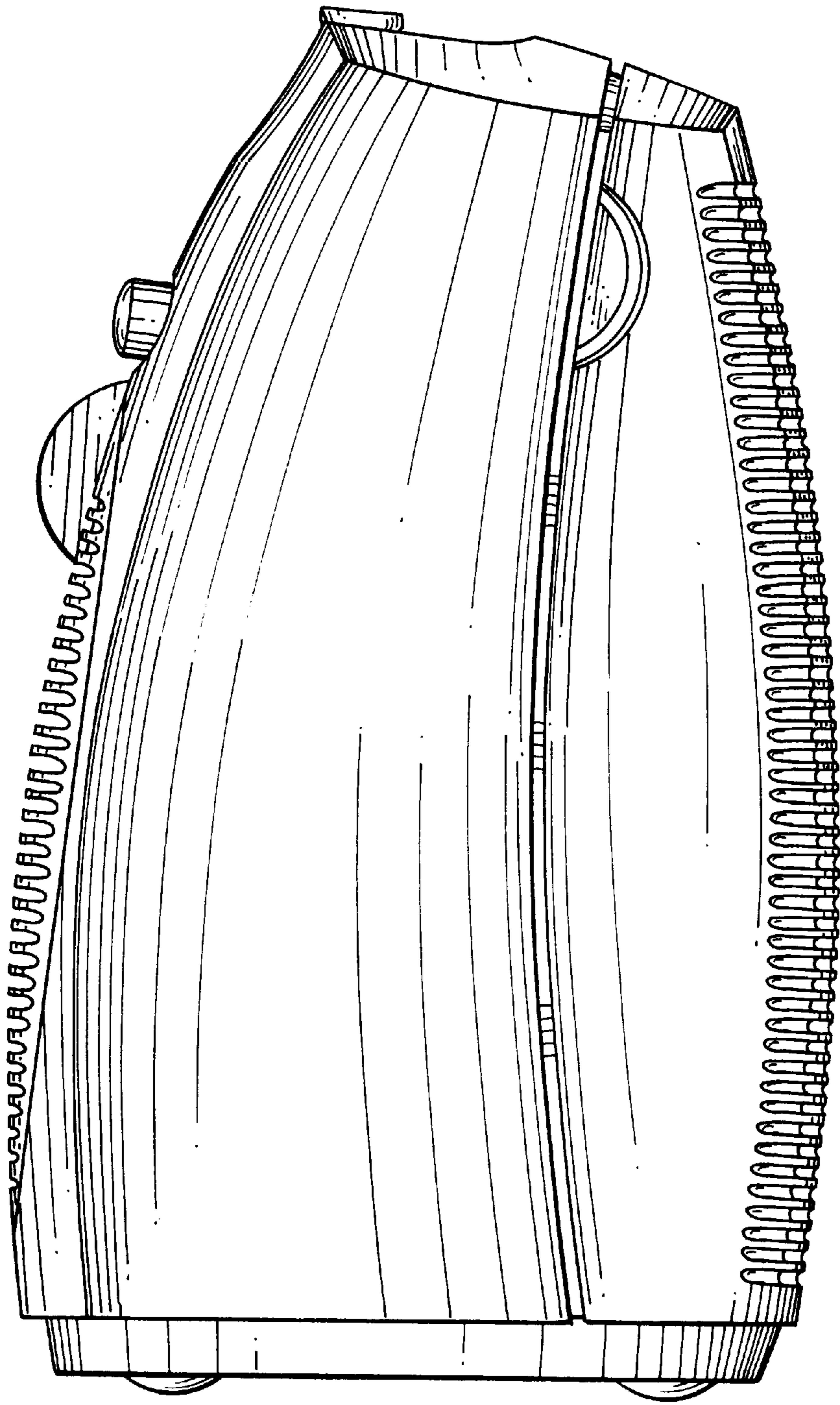

Fig. 3

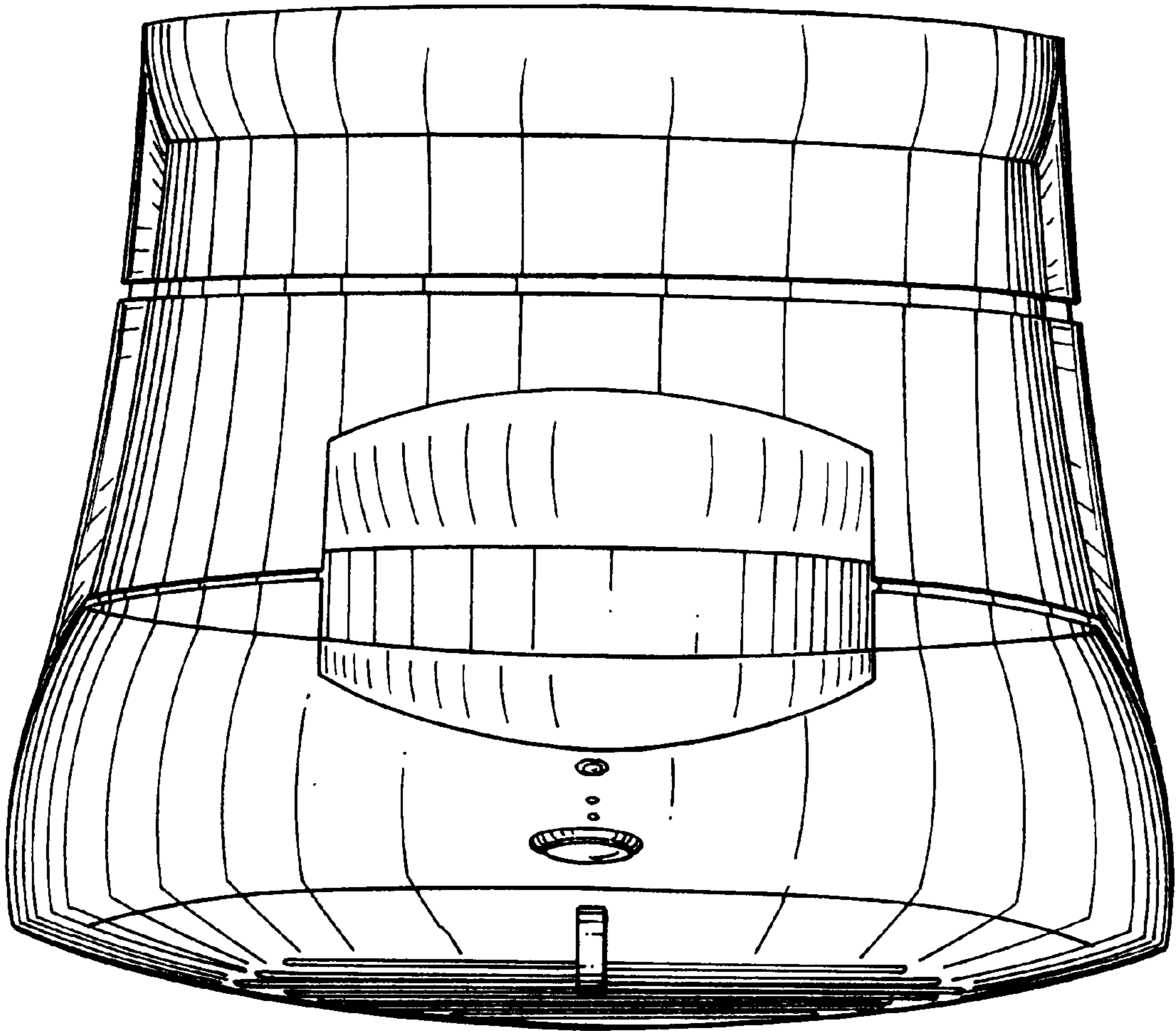

Fig. 4

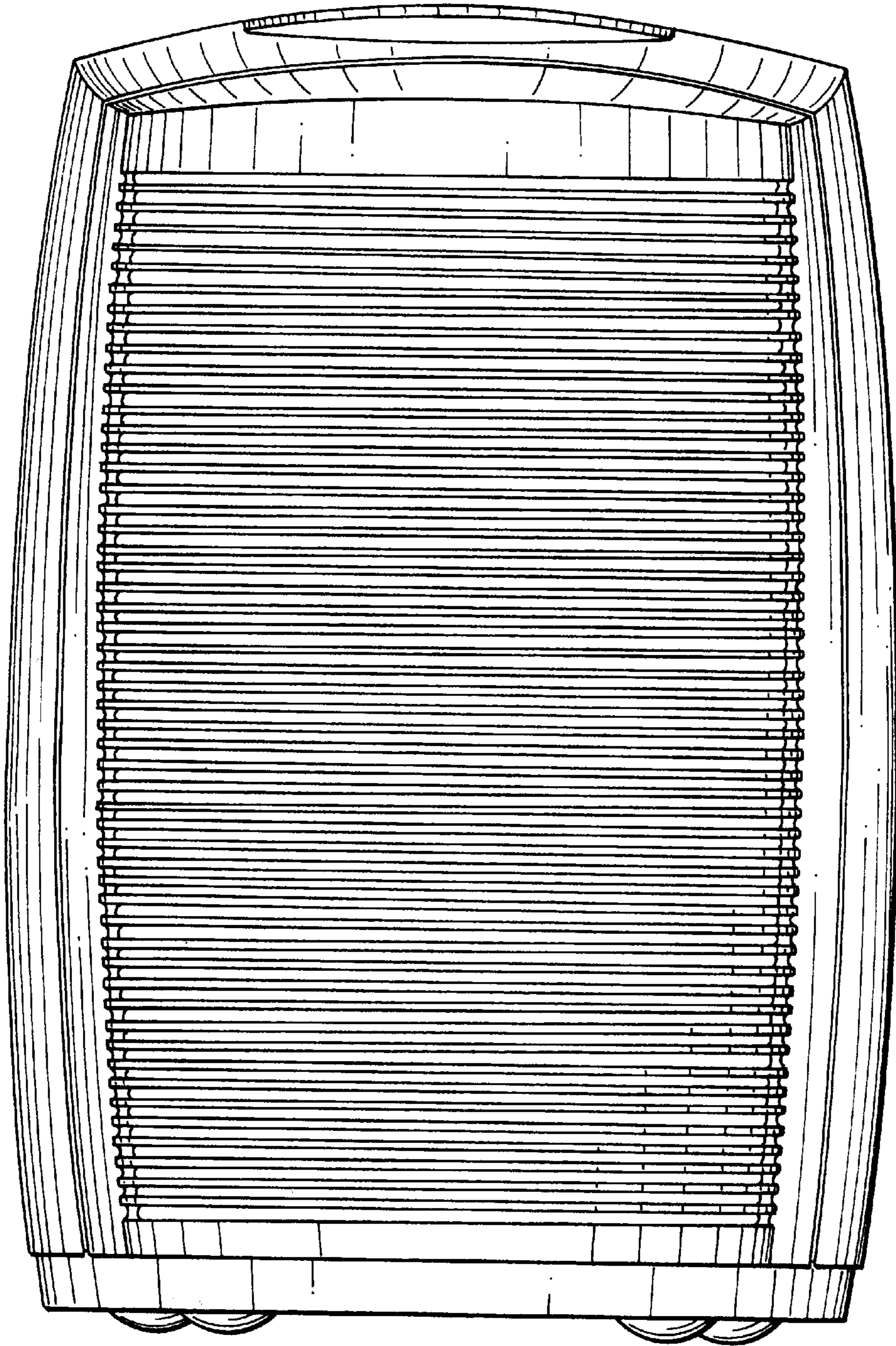

Fig. 5